















Unpacking

Before you begin using the device, please check the version you got and ensure that the following items are included in the shipped box:





Mainframe Accessories:

- | | | |
|--|--|--|
|  M3x5 crosshead screw x 4 |  M3x6 hex socket screw x 2 |  Sealing ring x 1 |
|  Wiring cover x 1 |  Sealing pressing plate x 1 |  Rubber plug x 3(S,M,L) |
|  Rope x 1 |  Allen wrench x 1 |  R27X x 1 |
|  ST1.7x4 crosshead screw x 2 |  Diode x 3 | |

Wall mounting Accessories (Please find in On-wall Installation Kit Box):

- | | |
|---|---|
|  ST4x20 crosshead screw x 6 |  Plastic wall anchor x 6 |
|  M4x30 crosshead screw x 2 |  Wall-mounting box x 1 |

Flush mounting Accessories (Please find in In-wall Installation Kit Box):

- | | |
|--|--|
|  ST4x20 crosshead screw x 6 |  Plastic wall anchor x 6 |
|  M4x10 crosshead screw x 6 |  Flush-mounting bracket x 1 |
| |  Flush-mounting box x 1 |

Product Overview

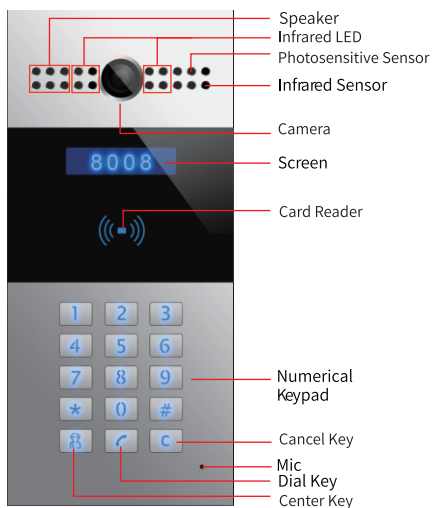

R27A

Installation Environment

Please don't place device under direct sunlight, which will bring bad effect and take damage to device with high temperature.

If installing the device indoors, please keep device at least 2 meters away from light, and at least 3 meters away from window and door .

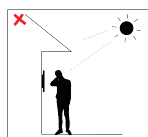

Backlight

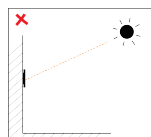

Direct sunlight

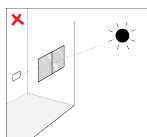

Direct sun through window

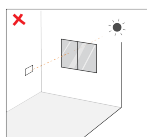

Indirect sunlight through window

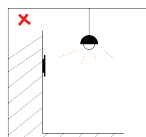

Close to light

Installation

Step 1: Wall-mounting Box or Flush-mounting Kit Installation

1. Wall Mounting

1.1 With 86x86 mm embedded junction box in the wall

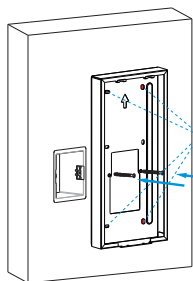

Fix the wall-mounting box on to the embedded box (86) with two M4x30 crosshead screws, mark the positions of the four holes of the wall-mounting box at the hole center.

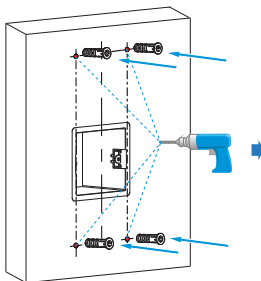

Take off the box and drill the four marked holes with a depth of 25 mm using 6 mm drill bit hand drill before inserting the plastic wall anchors into the drilled holes.

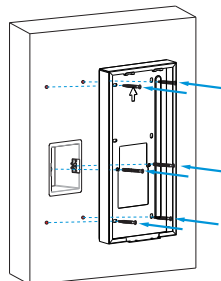

Fix the wall-mounting box with four ST4x20 crosshead screws and two M4x30 crosshead screws.

1.2 Without embedded junction box in the wall

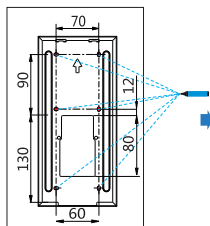

According to the position of the wire on the wall, put the wall-mounting box closely on to the wall and mark the six positioning holes, while making sure that relative positions between wall-mounting box and wiring hole are correct.

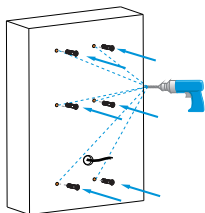

Use a hand drill with 6 mm diameter bit to make the holes in marked positions. And then insert the plastic wall anchors into the holes.

Waterproof Tips:
After the wall-mounting box is installed, it must be ensured that the EVA foam on the back is close to the wall and there is no gap between it and the wall.

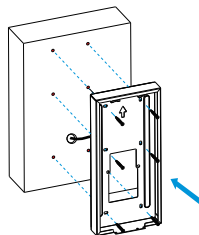

Fix the wall-mounting box with six ST4x20 crosshead screws.

2.Flush Mounting

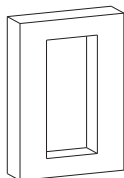

Cut out a square hole with the dimension height*width*depth = 264*122*61 mm.

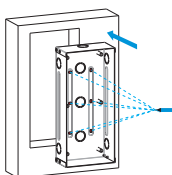

Insert the flush-mounting box in to the hole and mark the the positions of the six holes of the flush-mounting box on the wall.

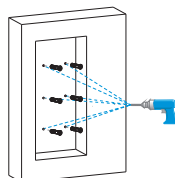

Take off the box and drill the holes on the marked positions with a depth of 25 mm using 6 mm drill bit hand drill before inserting the plastic anchors in to the drilled holes.

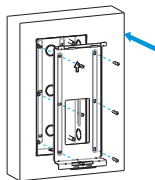

Use six M4x10 crosshead screws to fix the flush-mounting bracket on the embedded box.

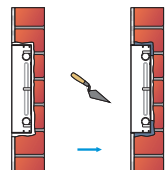

Use cement or non-corrosive structural adhesives to fill the gap between the wall and flush-mounting box. Wait the adhesive material desiccation, go to the next step.

Waterproof Tips:
Please make sure that the gap between the wall and the flush-mounting box is carefully filled to ensure that water does not seep into the machine through the gap.

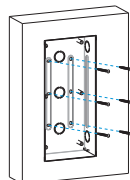

Break off the round knock-out wiring holes and lead the wires through the corresponding hole in to the flush-mounting box, then press the flush-mounting box in to the square hole until the edges of which align to the wall. Then fix the box using the four ST4x20 crosshead screws.

Note:
The flush-mounting box can not over the edge of the square hole.

Step 2: Wiring cover Installation

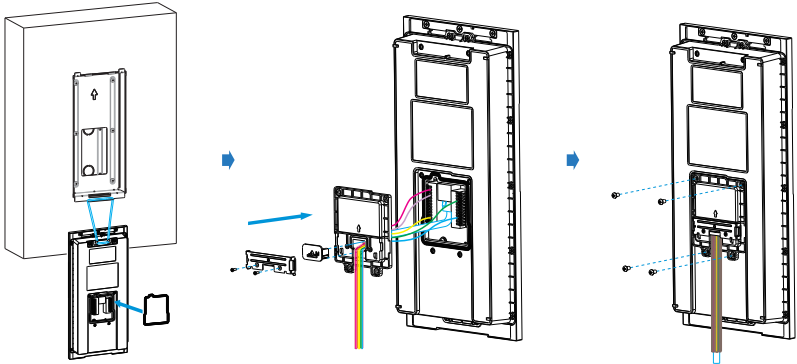

For convenient wiring, hang R27X on the wall-mounting box/flush-mounting bracket with rope. Then insert the sealing ring into the groove.

Make cables go through the wiring cover, connecting to the corresponding interfaces of the main board. Choose a suitable size rubber plug to compress cables, then fasten the sealing pressing plate with two ST1.7x4 crosshead screws.

Use four M3x5 crosshead screws to fix the wiring cover.

Step 3: Device Mounting

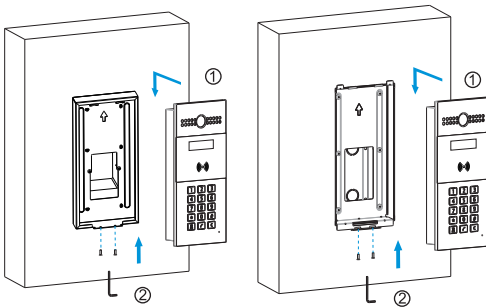

Wall Mounting

Flush Mounting

1. Place the device into the wall-mounting box/flush-mounting bracket until the edges of which align to the wall. Then pull the device downward and ensure the groove of it hooks to the lock catches of the back box.

2. Use the Allen wrench to tighten the device with two M3x6 hex socket screws.

Application Network Topology

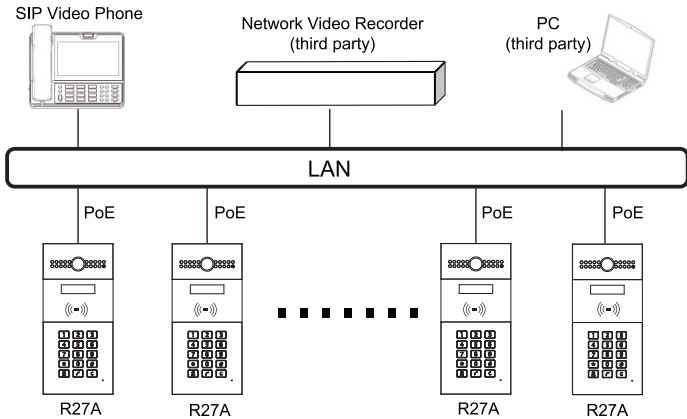

Device Wiring

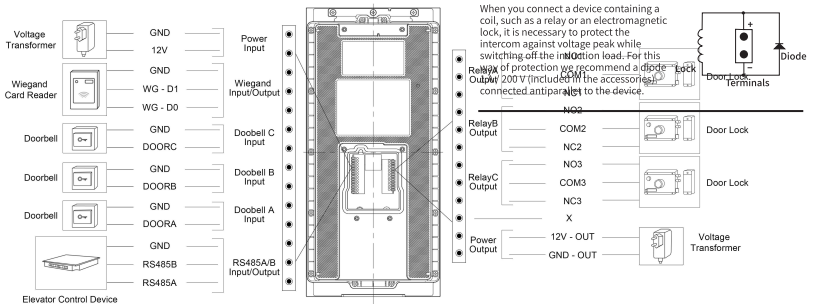

Wire Length & AWG Table

Please follow the properly measured wire gauge/length to install device:

	20 AWG	22 AWG	24 AWG	26 AWG
12V 1A Adapter	≤20m	≤10m	\	\

Configuration

1.IP Address Checking: Press *2396# to enter administrator setting interface. Click **System Information** to get the IP address. R27X uses DHCP by default.

2.Account Registration: On web UI, go to the path: **Account > Basic** page to register account and fill in the account information. (**Please refer to admin guide for more information**)

3.DTMF Code Configuration: On web UI, go to the path: **Intercom > Relay > Relay ID/DTMF** and choose the DTMF code number in corresponding area.

Operation

Make a call:

Input the room number, press **Dial key** to make a call.

Receive a call:

R27X supports Auto Answer by default. Incoming calls will be answered automatically.

Unlock by DTMF:

During the call, press the corresponding DTMF code of answer unit to unlock R27X remotely.

Unlock by Private Key:

In the keypad, enter “# + password + #” or “1+password+#” to open the door. (The latter is used for New version. Go to Web UI: **Intercom > Basic > Display Type** to switch Old or New version UI.)

Unlock by RF Card(Optional):

Place the predefined RF Card in the card reader area to open the door.

Notice Information

Akuvox R27X firmware contains third-party open source software under the terms of the GNU General Public License(GPL). Akuvox is committed to meeting the requirements of the GNU General Public License (GPL) and will make all required source code available.

The source code of software under the terms of GNU GPL can be downloaded online:<http://www.akuvox.com/gpl>.

Information contained in this document is believed to be accurate and reliable at the time of printing. This document is subject to change without notice, any update to this document can be viewed on Akuvox' s website: <http://www.akuvox.com>
© Copyright 2022 Akuvox Ltd. All rights reserved.



AKUVOX (XIAMEN) NETWORKS CO., LTD.

Add.: 10/F, NO.56 GUANRI ROAD, SOFTWARE PARK II, XIAMEN 361009, CHINA
www.akuvox.com

