

## ATTENTION:

Please monitor use when around children. Do not place near any heat sources or in direct sunlight. Strong direct light can cause the lamp to shut off and overheat. Do not block the lamp head and leave at least 15 inches above the lamp head and structures such as book case shelves. Do not cover the lamp with cloth, paper, or other flammable materials. Do not look directly into the light source to avoid damage to the eyes. Lamp is for indoor use only. Place lamp on a dry, flat, secure surface. Clean lamp with a dry or damp soft cloth. Never use cleaning solvents. Do not touch lamp with wet hands or use around liquids. Do not use lamp with frayed or damaged electrical cord. Do not use extension cords or power strips. Use ONLY the supplied AC power adapter. The adapter plug must be inserted into the electrical socket firmly. Unplug the adapter when the lamp will not be in use for long periods.

When unplugging the adapter be sure to grip the power cord by the adapter to avoid damaging it. Do not tamper, disassemble, replace parts, or try to repair the AC adapter. Do not repair, disassemble, or modify the lamp. (Warranty will be void) Never overload electrical circuits as it may cause electrical shock or fire. Unplug immediately if there is smoke or odor from the lamp.

### If the light does not turn ON/OFF or flickers please check these steps:

1. Long, 1-second touch on the color modes touch button. If this works but sensor does not work – contact us at [support@otusworld.com](mailto:support@otusworld.com)
2. Check power connection (lamp and socket)
3. Do not disassemble or attempt to replace any parts.
4. Contact us at [support@otusworld.com](mailto:support@otusworld.com)

## WARRANTY:

- 1) This lamp warranted against all manufacturing defects for 18 full months after the date of purchase with a FULL REFUND or REPLACEMENT.
- 2) Some shipping may apply.
- 3) Please refer all quality related issues by email: [support@otusworld.com](mailto:support@otusworld.com)

## WARRANTY DOES NOT COVER THE FOLLOWING CASES:

- 1) When product has been damaged due to user's mishandling, abuse, or improper operation.
- 2) When the product has been damaged due to the user's modification, attempted repair, or otherwise access to non-serviceable areas.
- 3) When the product is damaged due to floods, pollution, earthquakes, and any other natural or unnatural disaster, and acts of war or terrorism.

# LED DESK LAMP

## users manual

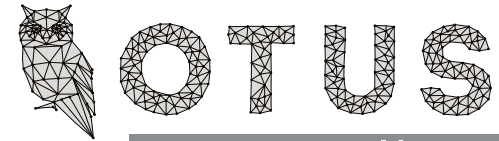

[www.otusworld.com](http://www.otusworld.com)

## OTUS LED desk lamp with MOTION CONTROL

MODEL: DL-002

POWER 10 W

### PACKAGE CONTENTS:

- Lamp stand with light
- Lamp base
- AC adapter
- Phillips screw
- Users manual

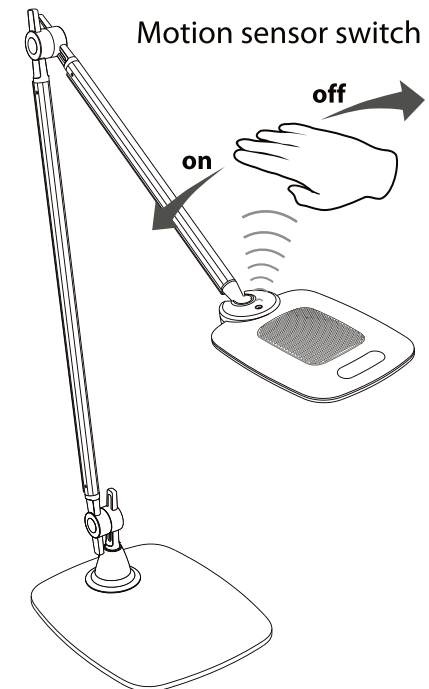

The hands-free LED table lamp offers 3 unique light color temperature settings and 12 brightness levels to give you 36 customizable settings.

This LED light produces a steady natural light that is free of glare and reduces eyestrain.

The electrical adapter uses a safe low voltage DC12V.



Motion sensor switch



Touch light modulation

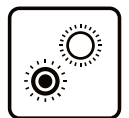

Color temperature light effect control mode

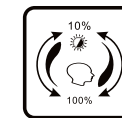

Intelligent memory stepless dimming



The unique optical effect arrangement

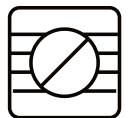

No strobes

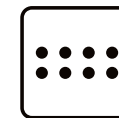

High brightness SMD LED

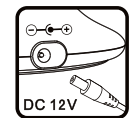

Low voltage output

## HOW TO ON/OFF THE LIGHT

Wave your hand over the shade to turn the light ON or OFF. The lamp is equipped with an infrared sensor.

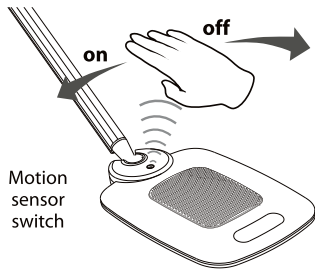

OR

Long, 1-second touch on the color modes touch button

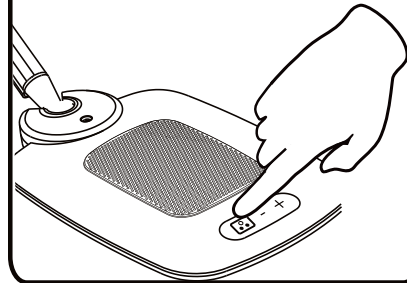

## INSTALLATION:

Insert the lamp stand with light into the base of the lamp securely. With a Phillips screwdriver, tighten the included screw into the bottom of the lamp base.

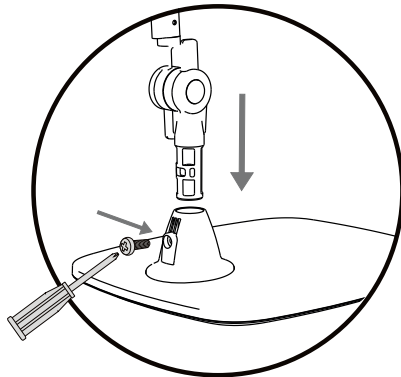

## ADAPTER:

Input voltage: AC100 - 240 V  
Output voltage: DC 12V  
The adapter may not work properly when the voltage is less than 90V  
The adapter should be used under input voltage of 100 - 240V

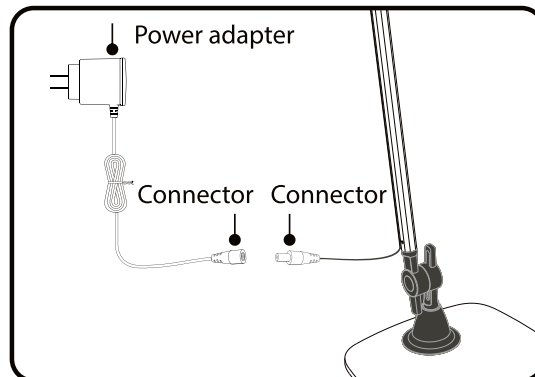

## BRIGHTNESS CONTROL FUNCTION

12 levels brightness control function. Simply touch the key "+/-" with a short or long touch for brightness adjustment.

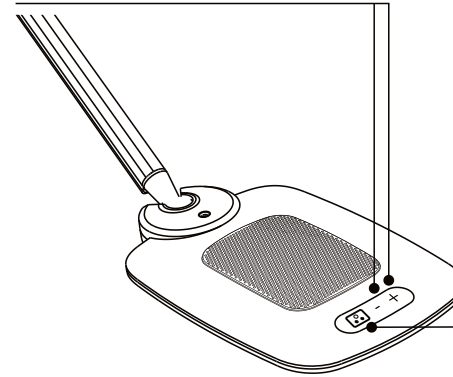

## COLOR MODES:

**READING MODE:** Daylight Light (4200K color temperature mode)  
Stimulates concentration and reduces eyestrain with mid-range illumination, favorable for office work and reading.

**STUDY MODE:** Cool Blue Light (6000K color temperature mode)  
Increases attention and concentration favorable for design and research

**RELAX MODE:** Warm Candle Light (3000k color temperature mode)  
Promotes relaxation and improves mood with low range illumination. Favorable for music, art, and creative activities.

## CONVENIENT ADJUSTABILITY

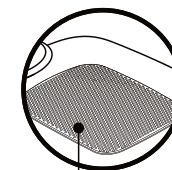
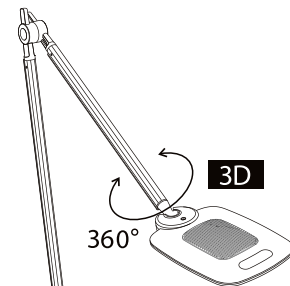

Perforated Stainless steel for better heat dissipation

