

# C500B Instructions

---



## CONTENT

---

About the user manual	-----2
Outlook and size	-----2
Button definition	-----3
Function outline	-----4
Setup outline	-----5
Common problems and solutions	-----6
Quality & Warranty	-----6
Error code table	-----7

# About the user manual

---

Dear users, in order to operate your electric car better, please read the C500B instrument manual carefully before use. We will tell you every step of the instrument in the most concise language, from hardware installation and setup to normal use of the instrument. At the same time help you solve the confusion and obstacles that may arise.

## Outlook and size

---

### Material and color

C500B products are made of black ABS material and the bracket is made of nylon material. Under the temperature of  $-20$  to  $60^{\circ}\text{C}$ , the shell material can ensure normal usage and good mechanical performance of the products.

Dimension figure (unit: mm).

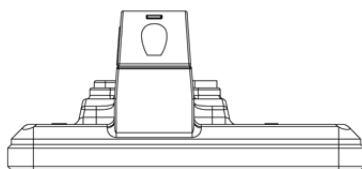
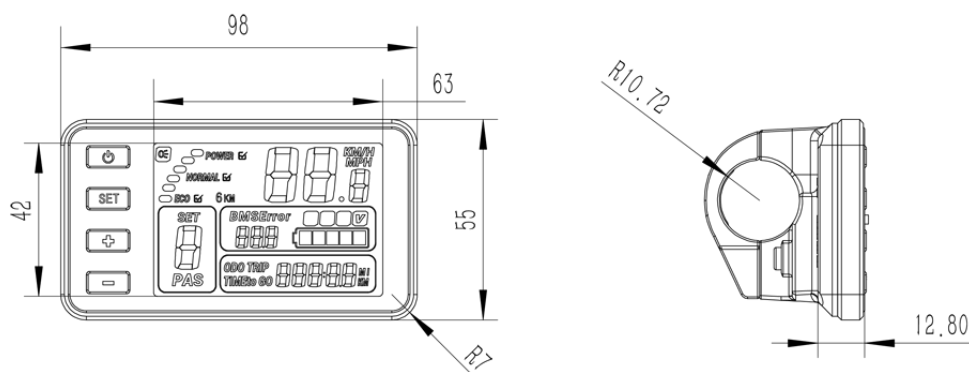

## Button definition

---

C500B has four buttons, including ON/OFF, SET, UP and DOWN

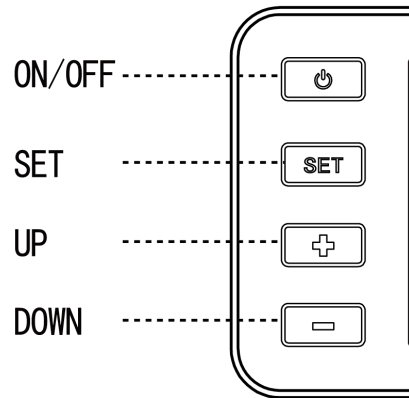

# Function outline

C500B provides a wide range of functions and indicators to fit the users' needs. The indicated contents are as below.

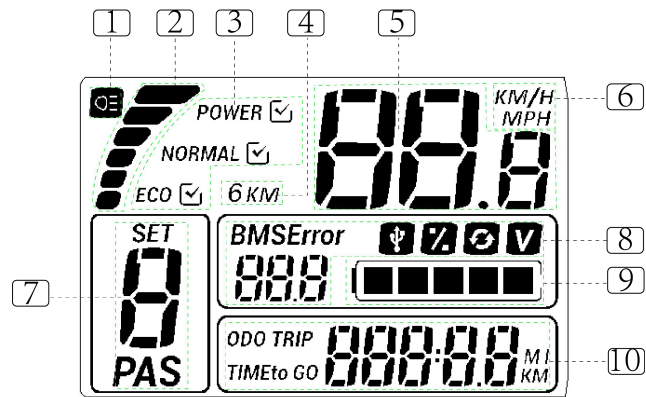

1. Backlight indicator:  
With the power on, click the ON/OFF turn on the backlight.
2. Current display:  
The discharging current of the controller currently, each segment is 2A.
3. Riding mode selection:  
Show current riding mode
4. 6KM/H work:  
Hold the DOWN for 2 seconds to get in 6km work.
5. Speed display:  
Display the speed at present.
6. KM/H&MPH:  
Select KM/H or MPH as the current display unit.
7. PAS&SET display  
7.1 SET display: The user enters the setup interface; the SET icon will be in 1Hz flicker.  
7.2 PAS: displays the current output power.
8. Battery information  
8.1 BMS&Error:  
BMS: display current battery status.  
Error: Displays the current error code.  
8.2 Charging display:  
Click SET and UP for 2 seconds, USB the charging icon will be lit.  
8.3 Electricity percentage display:  
This feature is not available by default.  
8.4 Cycle times display:  
This feature is not available by default.

## 8.5 Voltage display:

Display the current battery voltage of how many Volts.

9. Electric quantity display:  
Display current electric quantity.

10. Riding information display:

ODO:

The ODO records the driving mileage from using, the accumulated value cannot be cleared.

TRIP:

A single mileage display shows the user's single riding mileage, which can be cleared in the setup interface and 500KM automatically cleared.

TIME:

Display the time when the speed of a single ride is higher than 5KM/H.

TRIP TO GO:

This feature is not available by default.

# Setup outline

1. Click SET 2seconds enter the general setting interface.

SET0: Mode select (1: eco; 2: normal;3: power)

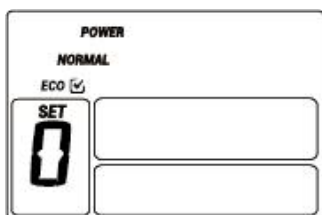

SET1: Reset Trip distance to 0.

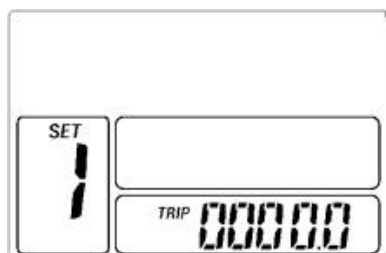

SET2: Max speed limited setting.



SET3: Wheel diameter setting.



SET4: KM/H&MPH



※press UP or DOWN to select the wanted parameter, and click SET for 1 second to exit

3. Wire order definition

Red: Battery+

Blue: Weak lock

Black: Battery-

Green: UART-RECEIVE (RXD)

White: UART- SEND (TXD)

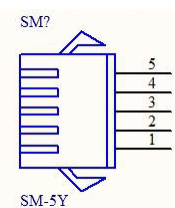

4. When the riding speed is 0 km/h for 5 minutes, the system will go to sleep automatically.

## Common problems and solutions

---

Q: Why the display is not able to start up?

A: Checking the connector that between display and controller.

Q: How to deal with the error code?

A: Fix it to the maintenance place immediately. If cannot be resolved, you can go to the electric vehicle repair points repair it in a timely manner.

## Quality & Warranty

---

Any quality problems in normal case and in guarantee period, our company will responsible for the warranty

The warranty time is 18 months from date of purchasing.

Other items:

The following items are not belong to warranty scope

1. It can't be demolished.
2. The damage caused by wrong installation or operation.
3. Shell is broken when display is out of the factory.
4. Wire is broken.
5. Force disaster (such as fire, earthquake, etc.) or natural disasters like lightning, etc caused by fault or damage.
6. Beyond Warranty period.

## Error code table

---

The error code is corresponding with the fault definition.:

Error code	definition
0	normal
1	Current error or MOS damaged
2	Throttle error(Start detection)
3	motor no phase position
4	Hall error
5	Brake error(Start detection)
6	Under voltage
7	Motor stalling
8	communication controller receiving error
9	communication display receiving error