

FH235-I/FH285-I

Inverter Heat Pumps





WARNING!

Risk of electric shock!

- A faulty electrical installation or excessively high voltage can lead to electric shock.
- Installation of heat pumps should only be performed by an authorized technician.
- Always disconnect the power supply before opening the heat pump for maintenance or repairs.
- Do not connect the heat pump if the incoming voltage does not match the required voltage on the unit's information plate.
- Do not operate the heat pump if there is visible damage to the incoming wiring.
- Repairs should only be performed by a qualified technician unless otherwise instructed. Liability and warranty claims are excluded in the event of improper repairs.
- Keep children away from the heat pump.
- Ensure that the heat pump's wiring is properly grounded or bonded before operating.



ATTENTION!

- The manufacturer is not responsible for damage caused by people, foreign objects, or inappropriate installation against these guidelines.
- Always provide proper ventilation and install away from any fire risks.
- Do not disconnect or attempt repairs on any lines containing refrigerant. Refrigerant repairs should not be performed in any confined space.
- It is vital to follow proper winterization procedures when the risk of hard freeze approaches, or the titanium heat exchanger risks being cracked or damaged. Such damage is not covered under the warranty and repairs will be the owner's responsibility.

Table of Contents

I. Included parts and accessories

II. Safety Information

III. Installation of the unit

IV. Technical Specifications

V. Electrical Wiring

VI. Operating Instructions

VII. Initial Operation

VIII. Operation and maintenance

IX. Error codes & Solutions

X. WiFi-Function

XI. Winterization

XII. Warranty Information

I. Included Parts and Accessories

Each unit includes the following accessories:

No.	Name	Qty.	Use
1	Instruction Manual	1 PC	Safety and installation manual (this document)
2	Drain-hose	1 PC	Used to direct condensation away from the unit
3	Drain-hose adapter	1 PC	Connects the unit to the drain hose
4	Rubber shock absorber	4 PCS	Limits friction with installation location
5	Heat pump unit	1 SET	Heats and cools water pumped through
6	Unions	2 SET	Connects the heat pump to 1.5" PVC

The heat pump requires the following components:

No.	Name	Qty.	use
1	Pool pump	1	Moves water through the system
2	Filter system	1	Prevents debris from reaching the unit
3	Plumbing	1	Connect the equipment and make circulation

NOTE

The exact amount and setup of the plumbing, valves, filter equipment, sterilizing equipment, etc. vary from one pool to another. At minimum, a pool pump and filter are required.

It is not recommended to install auxiliary electric heaters in the system. If absolutely necessary, auxiliary heaters must be installed and operated by qualified technicians. Fibropool cannot provide support for auxiliary heating systems.

Heat Pump Overview

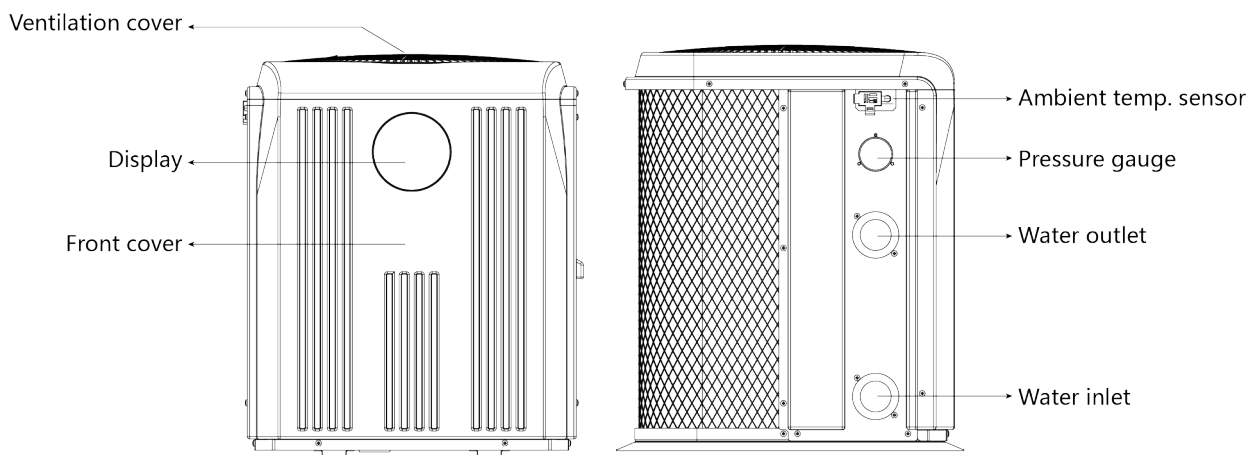

II. Safety Information

Required Operating Conditions:

1. Power supply: 208-230V 50/60Hz.
2. Air temperature: 35°F-105°F
3. Water temperature range:
45°F-104°F in Heating Mode
45°F-82°F in Cooling Mode

NOTE: Operating heat pumps at near-freezing temperatures risks damage to the heat exchanger. Heat pumps must be empty of water at freezing temperatures. See winterization guidelines for more details.

- Verify the ground connection before operation. Improper grounding increases the risk electric shock and death.

Grounding protects both swimmers and technicians from electric shock. It is absolutely necessary to properly ground the unit.

- Heat pumps should be installed outdoors when possible. If necessary, indoor installations must have adequate ventilation and clearance.
- Keep children away from the heat pump. The lock function can be used to prevent improper operation.
- Keep fingers and other objects away from the fan. Fan blades are extremely sharp and can cut or damage objects put inside.
- If you notice any unusual sounds, burning smell, electrical shorts, etc., please immediately disconnect the heat pump and contact Fibropool support.
- Do not install the unit near any combustible objects or materials.
- Install the heat pump such that the base rests on a solid, level foundation.
- When cleaning the unit, the heat pump should be off and disconnected from any power source.

III. Installation Instructions

3.1 Installation Diagram

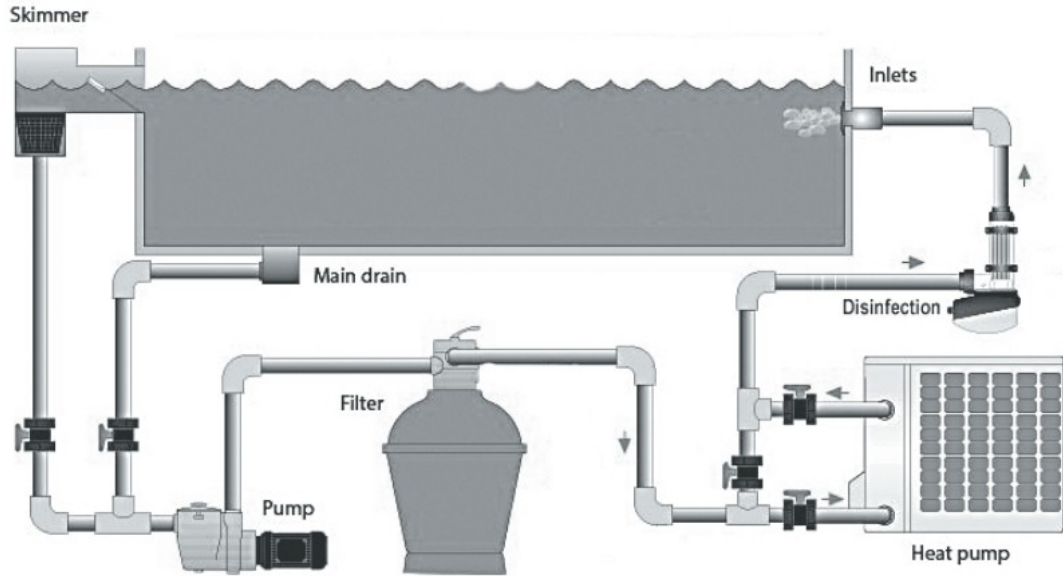

*The above diagram may not fit your exact installation. Please contact your pool technician or Fibropool technical support for assistance.

3.2 Installation Clearance

Proper clearance is mandatory to allow sufficient airflow and access for maintenance and repairs.

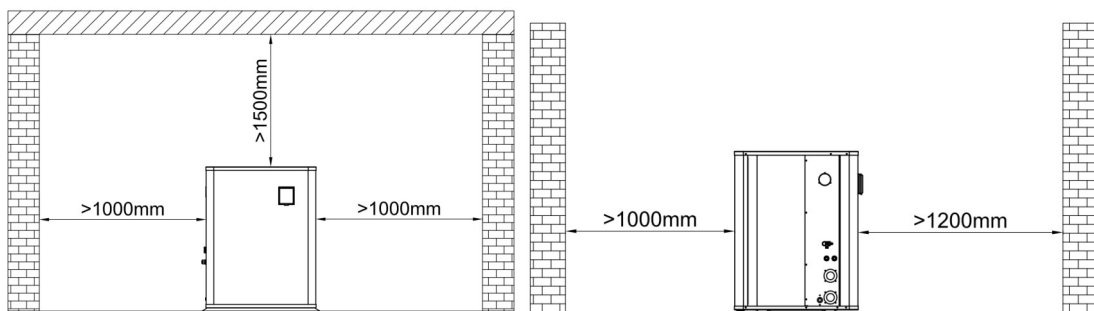

3.3 Additional By-pass kits

A bypass is recommended for all installations and is required for pumps larger than 1HP.



3.4 Heat pump unit size (mm)

FH235-I

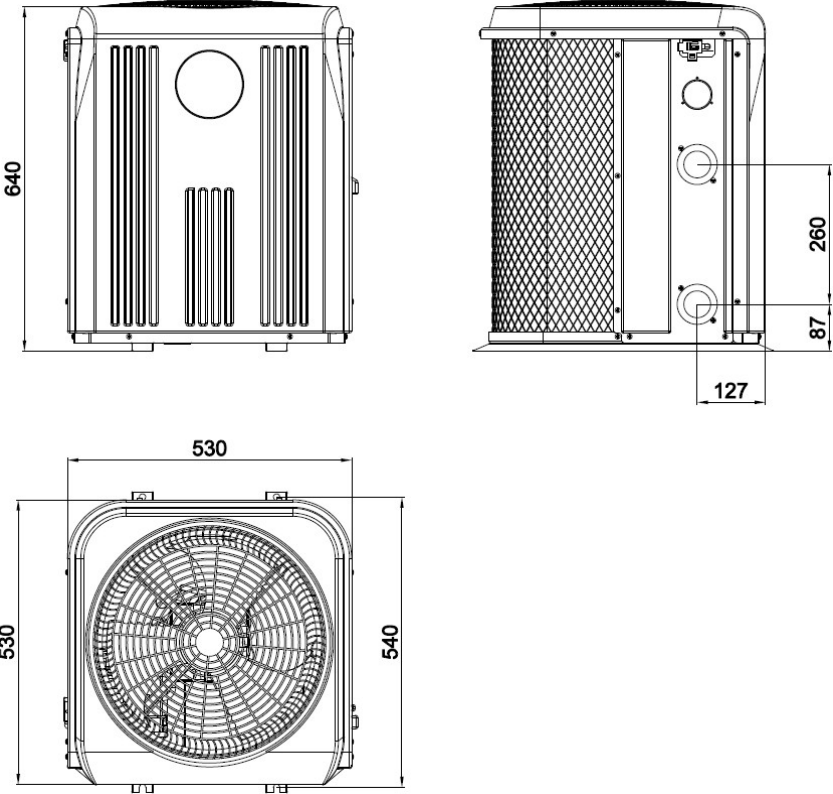

FH285-I

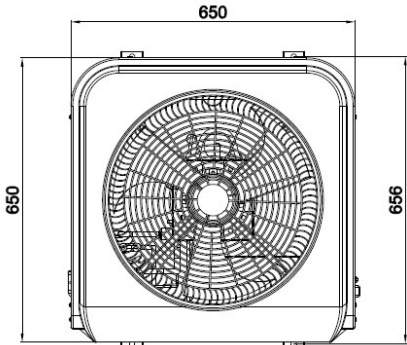
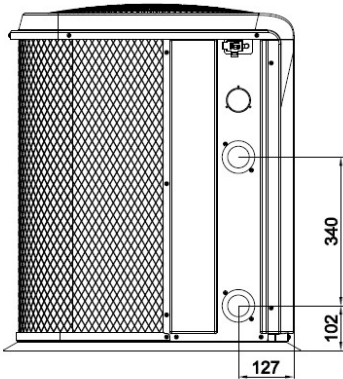
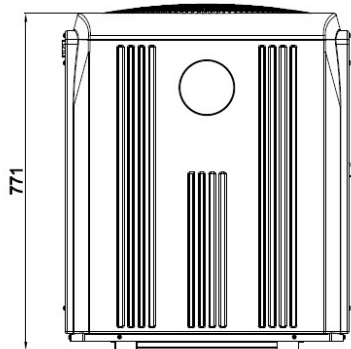

3.5 Heat pump Exploded View

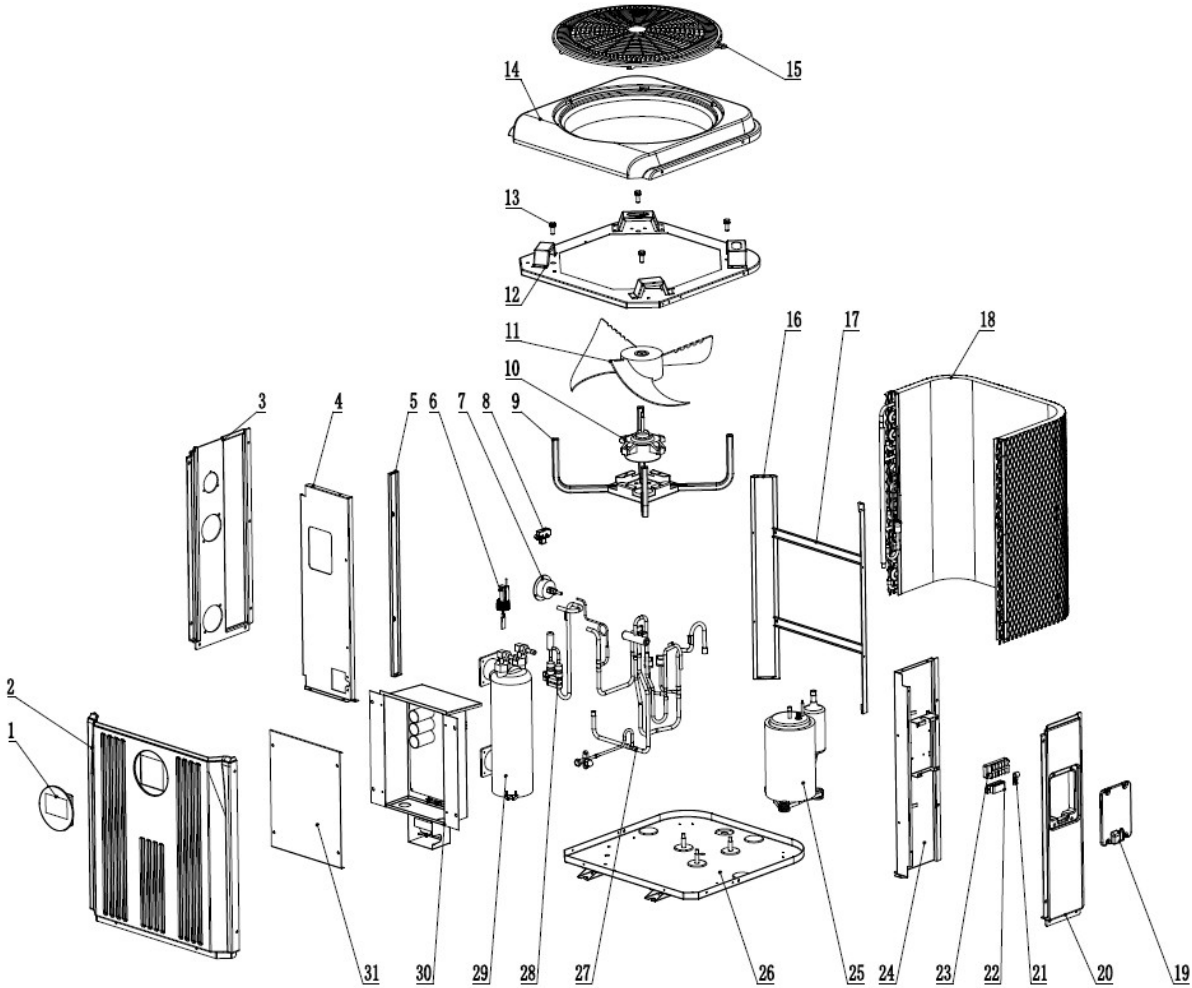

No.	Parts	No.	Parts	No.	Parts
1	Display	12	Top frame	22	Wire clip
2	Front panel	13	Bolt	23	Terminal
3	Side panel	14	Top cover	24	Pillar
4	Pillar	15	Ventilation	25	Compressor
5	Pillar	16	Pillar	26	Base tray
6	Water flow switch	17	Back frame	27	Four-way valve
7	Pressure gauge	18	Evaporator	28	EEV
8	Sensor clip	19	Wire cover	29	Titanium heat exchanger
9	Fan motor bracket	20	Side panel	30	Electric box
10	Fan motor	21	Wire clip	31	Electric cover
11	Fan blade				

3.6 Electrical connection

Model	Power Cable Specification
FH235-I	12 AWG
FH285-I	12 AWG
Terminal	Terminal cable max. 12 AWG

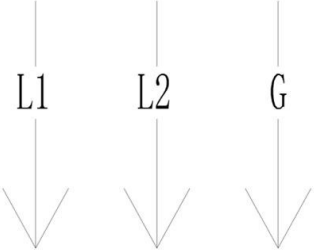
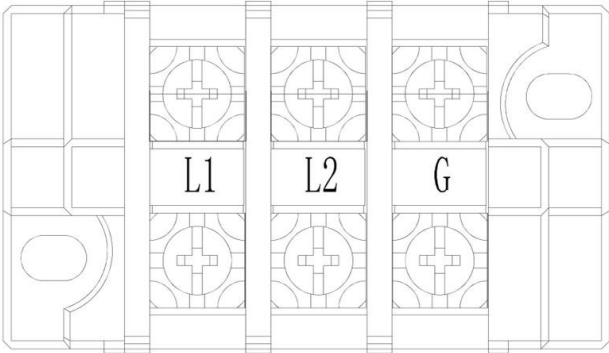

220-240V/60Hz

IV. Technical Specifications

4.1 Specifications

Model No.	FH235-I	FH285-I
* Heating Capacity at 80° Air Temp, Humidity 80%, Water 78° in, 82° out		
Heating Capacity (kW)	7.2~1.7	21~4.8
Power Input (kW)	1.06~0.11	3.09~0.30
COP	15.8~6.8	15.8~6.8
* Heating Capacity at Air 59°, Humidity 70%, Water 78° in, 82° out		
Heating Capacity (kW)	5.9~1.4	16.5~3.8
Power Input (kW)	1.2~0.18	3.37~0.5
COP	7.6~4.9	7.6~4.9
* Cooling Capacity at Air 95° , Water 84° in, 80° out		
Cooling Capacity (kW)	4.2~1.0	11.6~2.7
Power Input (kW)	1.11~0.15	3.05~0.4
EER	6.6~3.8	6.7~3.8
* General data		
Power supply	220-240V/60Hz	
Max Power Input (kW)	1.45	3.2
Max Current (A)	7.1	14.7
Water Flow Volume (gal/h)	660	1700
Refrigerant	R410a	
Heat Exchanger	Titanium	
Air Flow Direction	Vertical	
Defrost Method	4 way valve	
Working temp. range (° F)	20~150	
Casing Material	ABS	
Water Proof Level	IPX4	
Noise level 1m dB(A)	41~51	47~58
Noise level 10m dB(A)	21~31	27~38
Net Weight (lbs)	98	135
Gross Weight (lbs)	122	159
Net Dimensions (in)	20.9*20.9*25.2	25.6*25.6*30.3
Package Dimensions (in)	22*23.6*30.7	26.8*28.3*35.8

* Above data may change without notice.

V. Electrical Connections

5.1 Electric wiring diagram

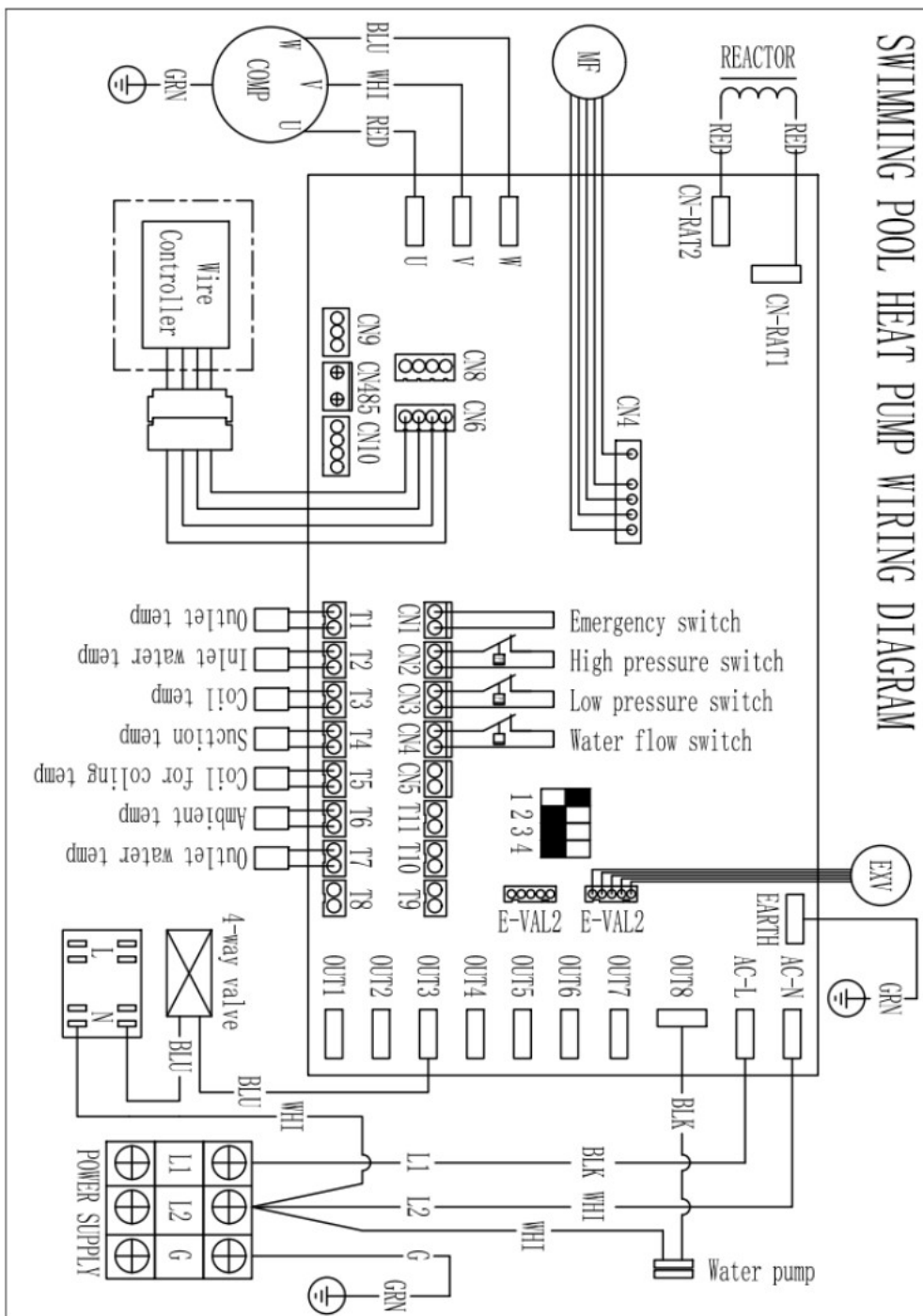



VI. Heat Pump Operation

6.1 Controller interface



6.2 Start up & Locking

Hold the power button  for 1 second to switch the heat pump on or off. This button is also used to return back to the main interface.

Hold the button  for 3 seconds to lock or unlock the display. (The lock will be activated automatically after 60 seconds of inactivity). When the display is locked, the logo  appears.





Note: Controller will need to be unlocked before changing any settings.

 **Attention: Before you start, make sure the filtration pump is running and that water is flowing through the heat pump.** Water flow is required for heat pump to start.

6.3 Temperature Mode Selection

From the main screen, press  to switch between temperature modes:

Auto  Heating  Cooling 

*While in Auto mode, if the heat pump is currently heating the display will show  and . In cooling mode, the display will show  and .

6.4 Operation Mode Selection

From the main screen, press  to switch between the following operational modes:



 **Silent mode:** Limits noise by reducing fan speed.



 **Eco mode:** Controls fan speed and compressor output to reduce energy usage.

 **Powerful mode:** Highest heating and cooling potential.



Note: Auto runs in Eco mode only. Other modes not available.



6.5 Temperature Adjustment







From the main screen, press  and  to adjust the desired water temperature of your pool.

When the  icon lights up, press the power button  to save.

6.6 Clock & Timer setting

From the main screen, press and hold  and  for 3 seconds to enter the clock setting. Press and hold them for 3 seconds again to enter the Timer setting, the  will flash.

Cancel timer: When you have set the Timer, under the Timer setting interface, hold  and  for 3 seconds again to cancel the Timer.

Clock or Timer setting: To adjust clock or timer settings, change the hours with  and , then press the  to edit the minutes. Change the minutes with  and , press  to confirm the setting and return to the main screen.



Note: There are 3 individual timers available for separate scheduling.

6.7 Other Icons



Note: On the main screen, the Water inlet temp. and Water outlet temp. will display alternately.

6.8 Manual Defrosting



Hold  and  for 3 seconds to start Manual defrosting function.

Note: These heat pumps enter defrost mode automatically when necessary. Contact Fibropool technical support if you encounter frequent defrosting or need to manually enable defrost.

6.9 Restoring Factory settings





Hold  and  and  and  for 5 seconds to restore factory settings.

6.10 Running Parameter checking

Hold  for 3 seconds to enter the parameter overview, then press  and  to check the parameters listed below:

Code	Description	Unit
A01	Inlet water temp.	°F
A02	Outlet water temp.	°F
A03	Ambient temp.	°F
A04	Exhaust temp.	°F
A05	Gas return temp.	°F
A06	Outer piping temp.	°F
A07	Inner piping temp.	°F
A08	EEV aperture	
A09	Compressor current	A (amps)
A10	Radiator temp.	
A11	Voltage value	V (volts)
A12	Frequency	Hz (Hertz)
A13	Fan motor speed	r/min (rotations/minute)
A14	Fan motor speed	r/min (rotations/minute)



6.11 Parameter setting

Hold  for 3 seconds to enter the Parameter setting, press  to select the parameter, then press  and  to set the new data for the below parameters.

Code	Description	Default	Scope
P01	Inlet water temp. in Heating mode	27°C	8~40°C
P02	Inlet water temp. in Cooling mode	27°C	8~28°C
P03	Inlet water temp. in Auto mode	27°C	8~40°C
P04	Water temp. difference before restart	1°C	1~18°C
P05	Heat pump ON/OFF when reached the desired water temp.	1	1 ON, 0 OFF

6.12 Wi-Fi Setting

Hold  +  for 5 seconds, enter the mode of intelligent net distribution

Hold  +  for 5 seconds, enter the mode of AP net distribution

6.13 Change Display of Temperature from (°C) to (°F)

Hold  for 5 seconds, if fail, try to hold it for 5 seconds again. When you see the icon is changed, then succeed.

Note: When the temperature display is changed, you need to set the Wi-Fi again.

VII. Initial Operation

7.1 Attention

- When first connected, allow water to flow through to purge air from lines.
- Always inspect electrical connections before operation. Verify that grounding lug is attached to a grounding rod or pool bonding according to local electrical codes.

7.2 Preparation Before Adjustment

- Ensure the system is installed correctly according to these guidelines.
- Check that water connections are secure and in the correct positions.
- Verify supply voltage is sufficient for heat pump operation.
- Verify adequate ventilation around the unit

VIII. Operating Instructions

8.1 To ensure proper operation, frequently inspect water and electrical connections. Follow the guidelines below when performing maintenance or repairs:

- Always disconnect the incoming power from the breaker or a shutoff switch before opening unit.
- Unless necessary or instructed by Fibropool, most default settings do not need to be adjusted.
- Frequently inspect electrical connections for loose or damaged wiring and components.
- Evaporator fins should be cleaned when dirty or every six months. An air compressor can safely remove most dirt and debris. A damp cloth can be used, but use caution as the fins are sharp and may tear the cloth and cut skin.
- After long periods of inactivity (after winterization, for example): inspect and clean all equipment, flush plumbing, inspect the pool pump, and recheck and tighten all electrical connections.
- Aftermarket replacement parts are not recommended and cannot be supported by Fibropool. Visit www.fibropool.com for replacement parts or contact technical support for assistance.

8.2 Draining Heat Exchange

When not installed for prolonged periods of time or in anticipation of hard freeze, the heat pump should be completely drained by tilting the outlet at least 45°. A shop vac is recommended to remove any remaining water. Plug the water inlet and outlet before storage to prevent insects and rodents from entering tank.

*** Warning: A heat exchange cracked due to freezing is not covered under the warranty for this product. It is the homeowner's responsibility to observe proper winterization procedures. See section XI: Maintenance and Winterization for more details.**

IX. Error Codes and Troubleshooting

Code	Description	Potential reasons	Solutions
	Water flow protection	Insufficient water flow	Ensure that water connections are in the correct order, that the pump is operating properly, and that all necessary valves are open
		Water flow switch disconnected	Check the wiring and reconnect water flow switch
		Water flow switch defective	Replace flow switch
E04	Antifreeze protection	Ambient/Inlet water temperature are too low	Wait for the ambient/inlet water temperature to increase
E05	High pressure protection	Insufficient water flow	Ensure that water connections are in the correct order, that the pump is operating properly, and that all necessary valves are open
		Ambient/ Water temperature is too high	Wait for the ambient/inlet water temperature to decrease
		Fan motor speed is abnormal or fan motor is damaged	Inspect fan motor, replace if necessary
		Excess refrigerant gas	Drain excess refrigerant*
		High pressure switch disconnected or defective	Reconnect or replace high pressure switch*
		Plumbing is clogged or jammed	Verify all plumbing is clear of obstructions and flowing properly
E06	Low pressure protection	Bad ventilation	Ensure the heat pump has sufficient clearance and adequate airflow. Clean the evaporator fins. Verify the fan is running correctly.
		Low pressure switch disconnected or defective	Reconnect or replace low pressure switch*
		Gas leakage	Verify that the pressure is within acceptable range. Repair leaks*
		Fan motor speed is abnormal or fan motor is damaged	Inspect fan motor, replace if necessary
		EEV blocked or piping system jammed	Verify all plumbing is clear of obstructions and flowing properly
E09	Connection failure between motherboard and controller	Bad wire connection	Check wire between motherboard and controller
		Defective controller	Replace controller
		Defective motherboard	Replace motherboard

E10	Communication failure between motherboard and driver module	Bad wire connection	Check wire between motherboard and controller
		Defective motherboard	Replace motherboard
		Defective Driver module	Replace driver module
E12	Excessively high exhaust temperature	Insufficient water flow	Ensure that water connections are in the correct order, that the pump is operating properly, and that all necessary valves are open
		Low refrigerant	Check gauge for pressure
		Plumbing is clogged or jammed	Verify all plumbing is clear of obstructions and flowing properly
		Defective exhaust temperature sensor	Replace sensor
E15	Inlet water temperature sensor failure	Sensor disconnected or defective	Reconnect or replace sensor
E16	Outer piping temperature sensor failure	Sensor disconnected or defective	Reconnect or replace sensor
E18	Exhaust temperature sensor failure	Sensor disconnected or defective	Reconnect or replace sensor
E20	Inverter module abnormal protection		Verify all incoming voltage and major electrical components
E21	Ambient temperature sensor failure	Sensor disconnected or defective	Reconnect or replace sensor
E23	Overcooling protection in cooling mode	Insufficient water flow	Ensure that water connections are in the correct order, that the pump is operating properly, and that all necessary valves are open
		Outlet water temperature sensor failure	Replace sensor
E27	Outlet water temperature sensor failure	Sensor disconnected or defective	Reconnect or replace sensor
E29	Suction temperature sensor failure	Sensor disconnected or defective	Reconnect or replace sensor
E32	Overheating protection in heating mode	Insufficient water flow	Ensure that water connections are in the correct order, that the pump is operating properly, and that all necessary valves are open
		Outlet water temperature sensor failure	Replace sensor
E33	Piping temp. too high protection under cooling mode	Ambient/water temperature is too high in cooling mode	Verify unit temperature limits
		Refrigerant system anomaly	Check refrigerant lines*

E42	Inner piping temperature sensor failure	Sensor disconnected or defective	Reconnect or replace sensor
E46	DC fan motor malfunction	Bad wire connection	Check fan motor wiring
		Fan motor defective	Replace fan motor



***Any manipulation of the refrigerant or related components must be performed by a qualified technician. Contact Fibropool technical support for assistance.**

X. WiFi Connection and Operation

Scan the QR code below with your phone's camera

for step-by-step WiFi connection and operation instructions

Hold  +  for 5 seconds to enter Wi-Fi pairing mode

Hold  +  for 5 seconds to enter Bluetooth pairing mode



XI. Maintenance and Winterization

- For best performance, we recommend setting the temperature and allowing your heater to run as often as possible.
- Clean your pool's filtration system regularly to avoid damage to the unit due to a dirty or clogged filter.
- Keep the coils clean by using a foaming air conditioner coil cleaner or pressurized air from an air compressor or air duster.

- Winterization: If the unit is not running during winter months, disconnect the power supply and water connections, and drain water from unit by tilting the heater toward the water inlet side at a 45 degree angle. A shop vac can also be used.
- Winterization: If possible, store the unit indoors after disconnected to minimize risks of freeze damage or excessive wear due to winter conditions.
- After the unit is winterized, it is ideal to cover the unit with a tarp or similar cover.

*** Warning: A heat exchange cracked due to freezing is not covered under the warranty for this product. It is the homeowner's responsibility to observe proper winterization procedures.**

FIBROPOOL HEAT PUMP LIMITED FACTORY WARRANTY

This warranty certificate applies only to FibroPool brand electric heat pumps
Fibropool Co. LLC warrants this Pool/ Spa Heat Pump, to the original owner, to be free of material and workmanship
defects for a limited TEN(10) year term.

Heat pumps utilizing Fibropool Titanium Heat Exchangers carry a lifetime warranty on the titanium coil tubing.
Specific warranty terms are listed below.

This warranty will begin on the day of purchase, verified by the homeowner's proof of purchase documents.

The full warranty term includes parts and labor charge to remove, repair or replace defective
components or failure due to workmanship

CLAIMS FOR WARRANTY REIMBURSEMENT MUST HAVE PRIOR AUTHORIZATION BY FIBROPOOL and be performed by a
qualified person .This warranty does not cover transportation charges for equipment or component parts to and from the factory.

PROOF OF PURCHASE REQUIRED FOR WARRANTY COVERAGE

This warranty is applicable only if the unit's installation and operation is expressly and completely followed in
accordance with the purchase model's Owner / Installation manual.

These documents are furnished with each unit and are available by contacting Fibropool Co. LLC.

The liability of Fibropool Co. LLC. shall not exceed the repair or the replacement of defective parts under the
including refrigerant or transportation to or from the Fibropool Service Center.

Fibropool Co. LLC. Is not liable for any damages of any sort whatsoever, including incidental and consequential.

This warranty does not include damage to any internal piping or components due to freezing conditions,
negligence and abuse, installations in corrosive environments or atmospheres, nor acts of God.

There are no implied warranties of merchant ability of fitness for a particular purpose that apply to this product.

To obtain warranty authorization, please contact: Fibropool Co. LLC., PO Box 2425, Bay Saint Louis, MS 39521 USA

Warranty Schedule:

	PRORATED WARRANTY COVERAGE IS AS FOLLOWS:
Lifetime parts warranty on titanium tubing heat exchange (plastic tank is excluded)	0-1 YEAR: 100%
1 Year Labor on the entire unit	1-2 YEARS: 90%
1 Year full on compressor, cabinet, motherboard and digital display	2-5 YEARS: 50%
2-10 years prorated warranty on the compressor, cabinet and digit display	5-10 YEARS: 25%
1 Year full warranty on all other parts	
2-10 years prorated warranty on all other parts	

Above mentioned warranties apply only to the original purchase. Warranty is non-transferable.

Fibropool will have the option to repair or replace the item if found to be defective after inspection.

Purchaser is responsible for shipping cost to and from the nearest warranty / repair center.

FIBROPOOL WILL NOT BE HELD RESPONSIBLE FOR ANY CONSEQUENTIAL, INCIDENTAL OR CONTINGENT DAMAGE

Some states do not allow exclusion of incidental and consequential damages and on how long implied warranty lasts; so above
conditions and limitations may not apply to you.

This warranty grants you specific rights which may vary from state to state.

Email: support@Fibropool.com

V2022.04