

FLEETWOOD FOLDING TRAILERS, INC.
INSTALLATION INSTRUCTIONS

1968A602
February 2007

BARKER ELECTRIC LIFT DEALER INSTALLATION INSTRUCTIONS
PART NUMBER: 4757G3781 – BALL BEARING WHIFFLETREE ONLY

These instructions are intended for 2000 to present model year trailers with a Ball Bearing Whiffletree Assembly.

This Kit Contains:

1	-	BMC P/N 30908	55:1 Power head
1	-	BMC P/N 30748 (Ball Screw Only)	Adapter assembly
1	-	BMC P/N 30747	Mounting assembly
1	-	BMC P/N 30897	Current limiter
1	-	BMC P/N 30898	Coil cord assembly
1	-	BMC P/N 623-0017	Shear pin
6	-	1201-870	Wire Clamps
2	-	4746-094	Brown squeeze connectors
10	-	4737-848	#10 Wood screws
3	-	4744A130	Shear pins
1	-	4744A050	Black TEK screw
7	-	4734J186	3/16" Black rivets
1	-	4773-315	1½" dia. white pry-out plug
14'	-	4060037501	Convolved tubing
6	-	1201-873	Wire clamp
14'	-	4021000003	Black wire
14'	-	4021000004	Red wire
2	-	4746-093	Yellow squeeze connector
6	-	1203C872	3/16" Steel rivet
2	-	4733-274	2" Grommet
1	-	4759-008	40 amp Circuit breaker
4	-	4800-001	¾" Hex head bolt
1	-	4742-810	1 ¼" Snap bushing

"BMC" stands for Barker Manufacturing Co.

IMPORTANT NOTICE

These instructions are for the use of qualified individuals specifically trained and experienced in the installation of this type equipment and related system components. Installation and service personnel are required by some states to be licensed. Persons not qualified shall not attempt to install this equipment nor interpret these instructions.

POWER HEAD INSTALLATION:

NOTE: You do NOT need to remove the rear body panel to install the power lift.

1. Manually crank the roof all the way to the top and support the top with a wood stick at each lift location. Next, crank backwards (counter-clockwise) five full turns to relieve the tension in the cables.
2. Remove the whiffletree guide pan and save the hardware.
3. Position yourself under the rear cross channel where the whiffletree screw comes through the rear cross channel. Locate the cut-out on the underside of the rear panel and the wood floor cut-out that allows you access to the drive chain and lower 12-tooth sprocket. Rotate the chain by hand until you have access to the disconnecting link. Remove the disconnecting link and then remove the chain.
4. Remove the upper crank drive hub shaft by first removing the crank handle shaft pin and then loosening the lock nut inside the shaft. After the lock nut is removed, the entire drive hub can be turned by hand counter-clockwise and unscrewed from the drive assembly.
5. Plug the hole in the rear panel where the drive hub came through using the white Heyco pry-out plug (4773-315). Push the plug into the hole and snap it into place.

NOTE: Panel plug not applicable with Highlander series models.

6. Remove the bearing housing from the rear cross channel by removing the four hex-headed bolts and lock nuts. The bearing, thrust nut, and bearing plate are visible as shown in Figure 1. Note that the bearing plate (4720C241) may be located behind the rear cross channel as shown in Figure 1, or it may be located on the outside of the cross channel behind the thrust bearing. The bearing plate will remain in its existing position. Save this hardware.
7. Next, punch out the drive pin from the 12-tooth sprocket and slide off the sprocket.
8. While under the trailer, check to see which type of pins are in the whiffletree screw stop bushings. If they are hollow roll pins, remove them from the front and rear screw stop bushings (4710B424) and replace with solid shear pins (4744A130) as shown in Figure 1.

CAUTION: Failure to perform Step 9 and make certain solid shear pins are installed in the screw bushings can damage the lift system and create a safety concern. Any problems or damages arising from failure to follow these instructions will be the sole responsibility of the installer.

NOTE: During this portion of the installation, disregard all of the parts you removed EXCEPT the following:

- Lock nuts (1201B603) – used to attach the bearing housing
 - Guide pan hardware
9. Slide the adapter (BMC P/N 30748) onto the end of the screw and attach the neck piece to the whiffletree screw using the zinc plated shear pin (BMC P/N 623-0017) as shown in Figure 2.

10. Next, slide the mounting assembly (BMC P/N 30747) over the adapter (BMC P/N 30748) onto the rear cross channel so that it aligns with the existing four bolt holes. Attach the mounting assembly to the rear cross channel using the long ¼" hex head bolts (4800-001) and existing lock nuts.
11. Place the power head (BMC P/N 30908) onto the mounting assembly (BMC P/N 30747) until the large groove pin inside the power head engages with the slotted end of the adapter (BMC P/N 30748). Use an Allen wrench to tighten the 5/16-18x ½" set screws to attach the power head to the mounting assembly at the three set screw locations. Refer to Figure 3 for a rear top view of the connected power head.
12. Manually crank the power head clockwise to raise the top to take up the slack in the lift cables. Make sure that as you crank through the power head, the whiffletree screw is turning to ensure the connection is in place.

NOTE: Do not crank the top all the way up because the support sticks may fall out and strike someone.
13. Reattach the guide pan with the existing hardware.
14. On Highlander models equipped with a tube bumper, make certain a hole exists through the bumper for the manual crank. If the hole does not exist, see Figure 7 to locate the center of a 2" diameter hole. Prior to drilling the hole through the bumper, hold the bumper in place to make sure the hole will align with the manual crankshaft. If the hole aligns, drill the 2" diameter hole through both sides of the bumper. Install a 2" grommet (4733-274) into each hole to cover the rough edges.

CURRENT LIMITER INSTALLATION

NOTE: Check the rear cross channel on the left side of the power head (BMC P/N 30908) for a hole pattern that matches the paper template in Figure 9. If the holes are pre-punched in the channel, skip to Step 2.

1. Cut out and place the paper template in Figure 9 on the outside of the rear cross channel as shown in Figure 4 so that the square hole in the template is located 10" to the left of the existing crank system hole. The template is stamped with a letter "L" for the left side and a letter "R" for the right side to illustrate the correct position. Tape the template to the channel and mark the four corner holes. Drill the 3/16" holes at the marked locations using a regular hand drill. Mark the square cut-out. Using a 3/8" drill bit, drill a hole at each corner of the square cut-out. Cut the square pattern out using a jigsaw with a metal blade.
2. Drill a 1 ¼" hole in the rear cross channel as shown in Figure 4. Insert the 1 ¼" snap bushing (4772-810) into the hole. Route the black wire connector plug from the power head through the snap bushing (4742-810).
3. Place the current limiter (BMC P/N 30897) with the cover plate on the inside of the rear cross channel so that the holes line up. Attach using the four black 3/16" Rivets (4734J186). Make sure to mount the current limiter with the wires on the left of the box as shown in Figure 5.

POWER HEAD AND CURRENT LIMITER WIRING

NOTE: The 12 VDC power head (BMC P/N 30908) will come packaged with two wires (red and black) emanating from the protective black rubber sleeve covering the power head. These two wires are pre-cut to lengths of approx. 8" with a quick disconnect plug on the end.

1. Pull the 12 VDC power head (BMC P/N 30908) wire bundle through the rear cross channel and attach to the underside of the floor with a wire clamp and a #10 wood screw (4737-848). Place the wire clamp as close as possible to the quick-disconnect plug on the end of the wire as shown in Figure 6.

NOTE: The current limiter (BMC P/N 30897) assembly will come packaged with four wires emanating from the controller housing. This wire bundle is pre-cut to lengths of 48". The two wires that connect to the power head wires will have a quick disconnect plug for easy connection.

2. Locate the converter in the trailer. Either remove the rear cover box or remove the converter from the front panel.

NOTE: Check the distance from the trailer converter to the power lift current limiter. If the distance is greater than 48", proceed to Step 3. If the distance is less than 48", skip to Step 10.

3. Connect the 10 AWG black wire in this kit to the 10 AWG white wire on the converter using a yellow connector (4746-093).
4. Connect the 10 AWG red wire in this kit to the 10 AWG black wire on the converter using a yellow connector (4746-093).
5. Feed both wires that were attached in the previous steps down through the same floor hole as the copper ground wire from the converter.
6. Route these wires through the holes in the frame cross channels to the last rear cross channel.
7. Cover these exposed wires with the convoluted tubing (4060037501) included in this kit. Place a wire clamp around the tubing and attach it to the floor between each frame cross channel using one of the wood screws (4737-848) provided. Leave the last section free and do not clamp it to the floor until it has been connected to the current limiter wires.
8. Take the two wires from the converter and cut them and the convoluted tubing to the desired length. Then, connect the **black wire** from the current limiter to the black 10 AWG wire under the floor using a brown squeeze connector (4746-094). Connect the **red wire** from the current limiter to the red 10 AWG wire under the floor using a brown squeeze connector (4746-094).
9. Place a clamp around these wires and connect it to the floor with the wood screw provided. Skip to Step 14.
10. Feed the black and red wires from the current limiter up through the same floor hole as the copper ground wire from the converter.

11. Attach the red wire to the 10 AWG black converter wire using a brown wire connector (4746-094).
12. Attach the black wire to the 10 AWG white converter wire using a brown wire connector (4746-094).
13. Cover the exposed wires under the floor with the convoluted tubing (4060037501) included in this kit. Place a wire clamp around the tubing and attach it to the floor between each frame cross channel using one of the wood screws (4737-848) provided.
14. Lastly, locate the 15 amp inline circuit breaker on your trailer battery wiring harness and replace it with the 40 amp included in this kit.

CAUTION: Failure to replace the breaker will not allow the power lift to operate.

NOTE: See Figure 8 for an overall wire schematic of the entire electrical hook-ups for the universal power lift kit. Prior to operating, make sure all of the wires are connected properly to ensure proper function of the system.

BARKER POWER LIFT OPERATING INSTRUCTIONS

READ SECTION "A" AND "B" TO FAMILIARIZE YOURSELF WITH THE POWER LIFT SYSTEM BEFORE FOLLOWING THE STEPS IN SECTION "C" THAT INSTRUCT YOU ON HOW TO PROPERLY AND SAFELY OPERATE THE POWER LIFT WITH A BATTERY.

A. GENERAL INFORMATION

Fleetwood Folding Trailers, Inc. (FFT) designed the electric power lift system to raise and lower the trailer roof without having to manually crank the lift system. **The electric power lift system is designed to operate ONLY while powered by a fully-charged 12VDC battery installed and connected to the trailer wire harness.** Do not operate the power lift system with the trailer's 30A power cord plugged into a 110VAC power source (whether at home or at the campground). If the trailer battery is dead or does not have a sufficient charge, then the power lift system can operate in two different back up modes:

1. If the tow vehicle 7 pin connector has a 12V wire lead connected to the tow vehicle's battery, then the electric power lift can be operated from the tow vehicle by keeping the trailer Bargman plug attached to the tow vehicle's 7 pin connector. The electric power lift will draw 12V power from the tow vehicle.
2. If the tow vehicle 7 pin connector does not have a 12V wire connected to the tow vehicle's battery, then hook up standard jumper cables from the tow vehicle's battery to the battery installed on the trailer tongue. The electric power lift will draw 12V power from the tow vehicle via the jumper cables.

NOTE: The 25A or 35A power converters installed in a Fleetwood Folding Trailer have a trickle-charge feature that will help to maintain the trailer battery 12VDC charge when the power cord is plugged into a 110VAC power source. Always make sure the trailer battery is fully charged prior to camping.

The electric power lift system consists of three basic components: (1) The power head bolted to the trailer frame rear cross channel; (2) The current limiter controller/microprocessor installed on the inside of the rear cross channel; and (3) The hand-held remote control with a plug connector used to attach to the current limiter. FFT designed the electric power lift to operate only when the hand-held remote controller is plugged into the current limiter. By pressing the UP or DOWN switch, the owner can raise or lower the roof of the trailer. If the hand controller is removed from the current limiter, the power head cannot activate. FFT also designed a manual over-ride feature to allow the owner to raise and lower the roof in case a 12VDC power source is not available (i.e., the battery is dead or the tow vehicle battery is not available). This can be accomplished by disconnecting the black wire quick disconnect plug between the current limiter and the power head as show in Figure 6. The manual over-ride feature is explained in Section D "Manual Over-Ride Operating Steps."

B. BASIC SYSTEM INSTALLATION CHECKS

1. Make sure the battery has been installed properly on the tongue of the trailer. The battery wire harness has a black and white wire with eyelet loops on the end to connect to the positive and negative terminal posts. Make sure the black power wire is connected to the positive (+) terminal post and the white ground wire is connected to the negative (-) terminal post. If these wires are reversed, the power lift controller will be permanently damaged upon operation.
2. The power head motor is bolted to the rear cross channel on the frame of the trailer and the current limiter controller (microprocessor) is riveted to the inside on the rear cross channel to the left of the motor. The wires are attached to the rear cross channel and trailer frame using wire clamps to prevent them from snagging or catching on anything during road travel or campground parking. The power head and controller wire connections are made on the underside of the trailer floor behind the rear cross channel. Make sure the wire clamps are all attached and no wires are hanging loose below the trailer frame.

C. STANDARD POWER LIFT OPERATING STEPS

1. Make sure the battery is fully charged. A battery that does not have a full or sufficient charge will not damage the controller or power head. However, the time to raise the top will increase substantially and the motor may seem to perform sluggish or struggle with the roof load (especially with trailers that have added weight on the roof including air conditioner, bike racks, canopy, etc.)
2. Make sure the trailer roof latches are released and open. Engage the crank-down or swing-down stabilizers and level the trailer per the owner's manual.
3. Flip up the plastic cap covering the current limiter controller receptacle. Take the hand controller and insert the plug end into the receptacle. Note that the plug will only fit into the controller receptacle in one position due to the design of the plug. You will not be able to pull the plug out of the receptacle until you push the release button. After securing the plug into the receptacle, you are ready to operate the power lift.
4. Again, make sure the trailer roof latches are released. Press the UP arrow on the hand-held switch to raise the top and the DOWN arrow to lower the top. You may stop the roof movement anytime during operation by simply removing your finger from the switch. Once the roof reaches the top or the bottom, the microprocessor in the controller system will automatically shut

off the motor and prevent any further movement in the top. Fleetwood designed the power lift with this automatic shut-off to prevent damaging the lift cable and pulley system and also prevent supplying excess power that could potentially over heat the controller and power head. Once the roof has reached the top or the bottom of a cycle, continuing to press the UP or DOWN arrow in the *direction* of the motion will not provide any power to the motor. In order to operate the motor again after reaching the end of a cycle, you must press the switch in the opposite direction of the motion. For instance, if you raise the roof to the top and the motor shuts off, then you can only power the motor by next pressing the DOWN arrow. And vice versa, if you lower the roof to the bottom and the motor shuts off, then you can only power the motor by next pressing the UP arrow.

5. After raising the roof to the top or lowering the roof to the bottom, remove the remote hand controller by pushing the release button and then pulling the plug out of the receptacle.

NOTE: The hand controller has a coiled cord that provides you with the ability to move from side to side to watch the roof raise or lower. During the tear down of a trailer, you can check to make sure all of the tenting is carefully tucked under the roof. Make sure you store the remote hand controller in a safe and waterproof area of the trailer or tow vehicle. The hand controller is not designed to be left outside in inclement weather.

D. MANUAL OVER-RIDE OPERATING STEPS

FFT designed the power lift system to have a manual over-ride capability in case there is no available DC power source. The power head motor has a dynamic brake built into the system that prevents the motor gears from turning easily on their own when the hand controller UP or DOWN switch is not pressed and operating the motor. The dynamic brake is engaged whether or not a battery or DC power source is hooked up to the power lift system. Therefore, simply disconnecting the black and white battery wire harness from the battery will not disengage the dynamic brake and cause the top to free fall. The only way to disengage the dynamic brake is to disconnect the black quick disconnect plug next to the electric motor. See Figure 6. In order to disengage (and then re-engage) the dynamic brake, follow these steps:

1. If you do not have any power source available to operate the power lift (i.e., low/dead battery or no tow vehicle battery available), then you can manually crank the roof up or down by disengaging the dynamic brake in the power head.
2. Locate the black quick disconnect plug behind the rear cross channel. Disconnect the plug to disengage the dynamic brake.
3. In order to raise the top, insert the manual crank handle into the hole in the rear cross channel so the end meets the power head shaft with a pin. Rotate the crank handle clockwise to raise the roof. Continue cranking until the crank stops. While holding the crank at the top, reconnect the black quick disconnect plug to engage the dynamic brake. This will prevent any slow creep of the top in the downward direction. If necessary, you can manually crank the roof up with the dynamic brake *engaged* without damaging the controller or the power head. However, you will notice that it is very difficult to turn the crank because you are working against the brake.
4. In order to lower the roof, insert the crank handle into the hole in the rear cross channel so the end meets the power head shaft with a pin. Disconnect the black quick disconnect plug and rotate

the crank handle counter-clockwise. Upon reaching the bottom, reconnect the black quick disconnect plug to engage the dynamic brake.

NOTE: The power lift will not operate with a battery unless the dynamic brake is engaged. Try manually cranking the lift. If the crank is extremely hard to turn, then the brake is engaged and you can operate the power lift with a battery. If the crank is very easy to turn, then the brake has been disengaged. In order to operate the lift with a battery, you must reconnect the black quick disconnect plug to engage the brake.

FIGURE 1

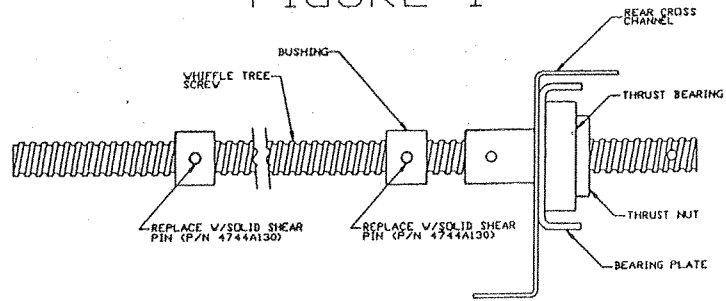

FIGURE 2

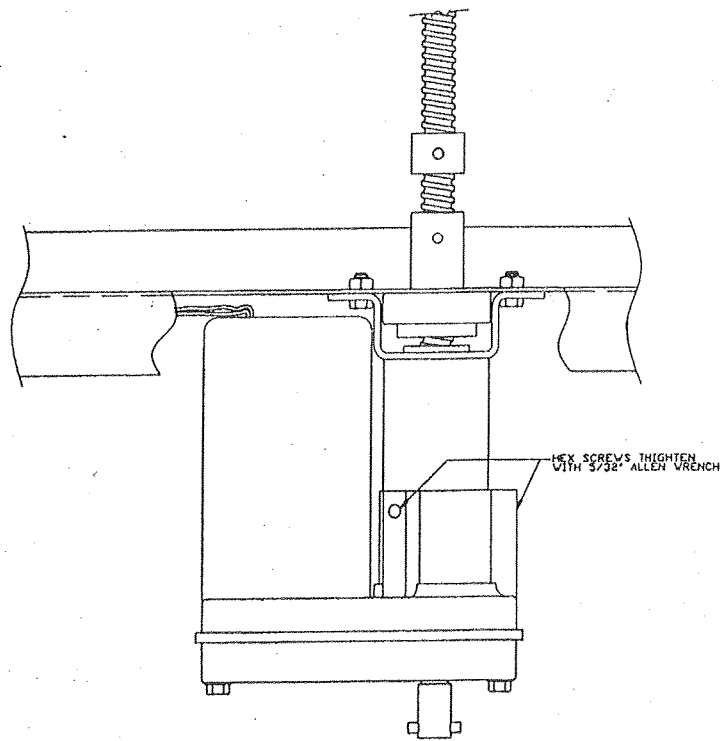
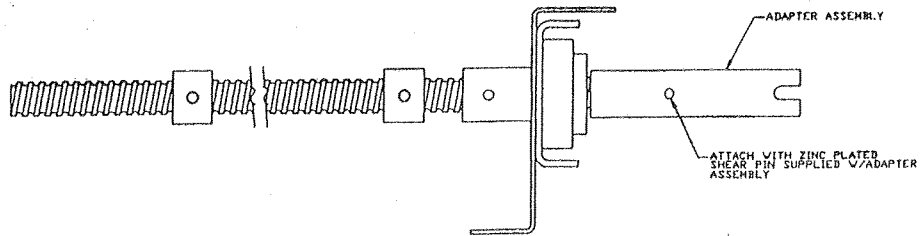

FIGURE 3

REAR TOP VIEW OF CORRECT MOTOR POSITION

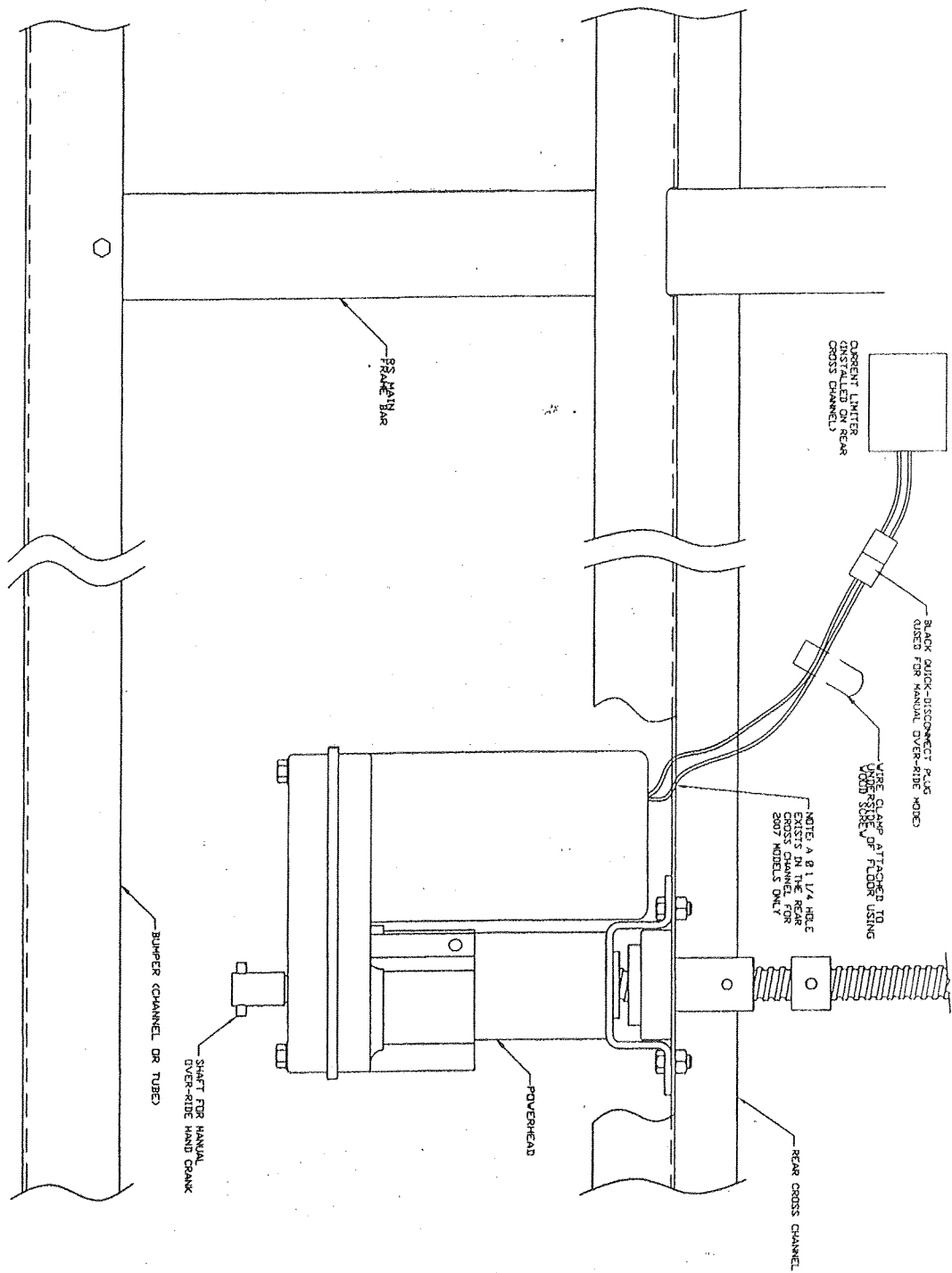
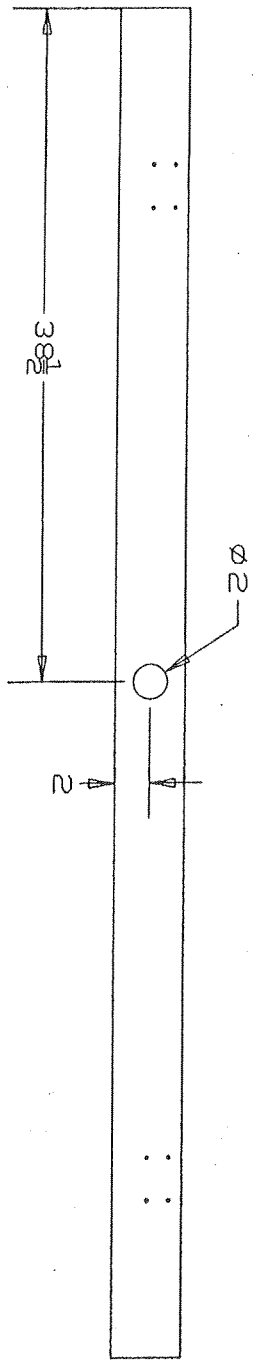
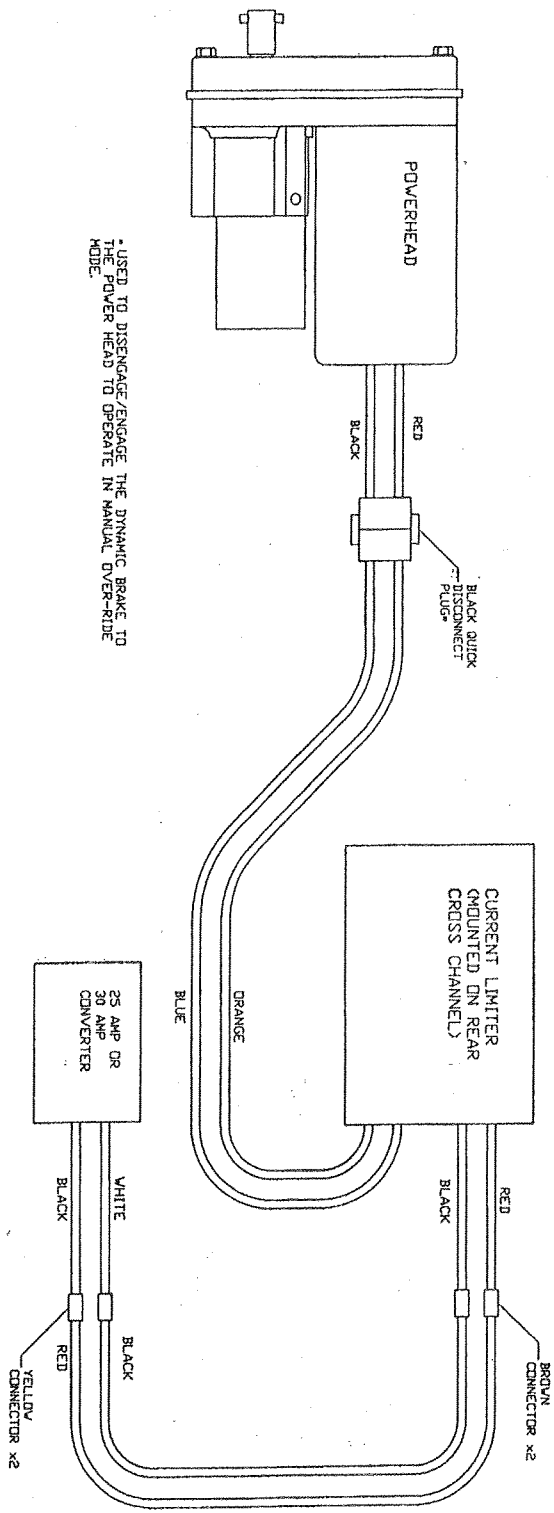

FIGURE 6
 POWER HEAD
 INSTALLATION AND WIRE
 ROUTING

FIGURE 7



1968ES17



- USED TO DISENGAGE/ENGAGE THE DYNAMIC BRAKE TO THE POWER HEAD TO OPERATE IN MANUAL OVER-RIDE MODE.

FIGURE 8
UNIVERSAL POWER LIFT KIT WIRE SCHEMATIC

FIGURE 9

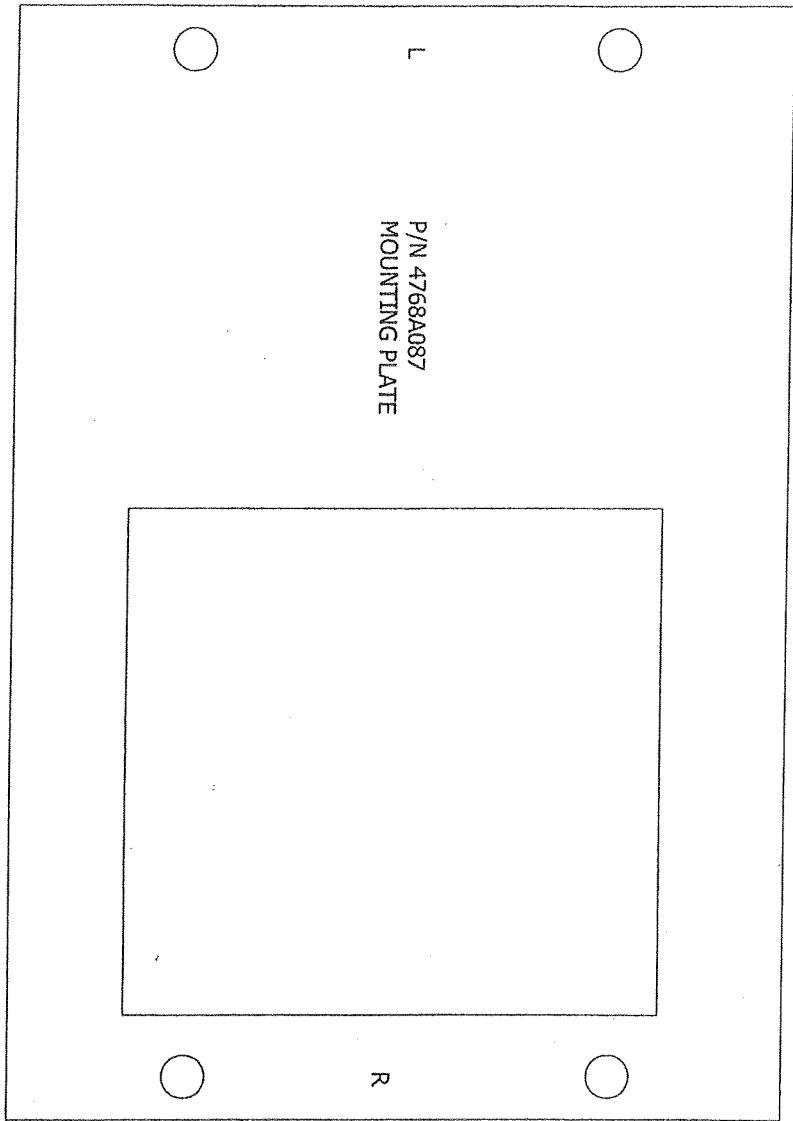

1968A602