



**2007  
OWNER'S MANUAL**

# TABLE OF CONTENTS

<b>INTRODUCTION</b> .....	<b>1</b>
IDENTIFICATION INFORMATION .....	2
<b>IMPORTANT CONSUMER INFORMATION</b> .....	<b>2</b>
REPORTING SAFETY DEFECTS .....	2
NOTICE TO DEALER AND CONSUMER .....	2
<b>2007 FLEETWOOD FOLDING TRAILER LIMITED WARRANTY</b> .....	<b>3</b>
LIMITED WARRANTY GENERAL EXCEPTIONS AND EXCLUSIONS .....	4
<b>PRE-TRIP PREPARATIONS</b> .....	<b>5</b>
<b>TOWING GUIDELINES</b> .....	<b>7</b>
TOWING REQUIREMENTS: Tow Vehicle, Towing Package, and Trailer.....	7
TOW VEHICLE .....	7
HITCHES*.....	7
TRAILER.....	9
TOWING .....	10
BRAKE SYSTEM (where defined by state or provincial regulations).....	11
BRAKING TIPS.....	13
WEIGHING YOUR TRAILER .....	13
DEFINITIONS OF TRAILER WEIGHTS, RATINGS, AND TERMS .....	13
APPROXIMATE WEIGHTS OF COMMON ACCESSORIES .....	16
<b>TIRE AND CARGO INFORMATION</b> .....	<b>16</b>
INTRODUCTION.....	16
SECTION 1 .....	18
SAFETY FIRST-BASIC TIRE MAINTENANCE .....	19
FINDING YOUR TRAILER'S RECOMMENDED TIRE PRESSURE AND LOAD LIMITS .....	19
UNDERSTANDING TIRE PRESSURE AND LOAD LIMITS.....	19
CHECKING TIRE PRESSURE .....	19
STEPS FOR MAINTAINING PROPER TIRE PRESSURE .....	20
TIRE SIZE .....	20
TIRE TREAD .....	20
TIRE BALANCE.....	20
TIRE REPAIR .....	20
TIRE FUNDAMENTALS .....	20
INFORMATION ON PASSENGER VEHICLE TIRES.....	21
ADDITIONAL INFORMATION ON LIGHT TRUCK TIRES .....	23
TRAILER LOAD LIMITS .....	23
CARGO CAPACITIES .....	24
HOW OVERLOADING AFFECTS YOUR RV AND TIRES .....	24
TIRE SAFETY TIPS .....	24
PREVENTING TIRE DAMAGE.....	24
TIRE SAFETY CHECKLIST .....	24
SECTION 2 .....	25
STEPS FOR DETERMINING CORRECT LOAD LIMIT .....	25
SECTION 3 .....	25
GLOSSARY OF TIRE TERMINOLOGY .....	25
<b>SET-UP INSTRUCTIONS</b> .....	<b>27</b>
LIFT SYSTEM OPERATION .....	28
CRANK-UP/CRANK-DOWN LIFT SYSTEM .....	28
POWER LIFT SYSTEM (where applicable).....	28
STABILIZER JACKS .....	29
CRANK-DOWN STABILIZERS.....	29
SWING-DOWN STABILIZERS.....	29
BEDS.....	29

GLIDE-OUT COMPARTMENT (where applicable) .....	30
TENT ENCLOSURE .....	31
GLIDE-OUT MODELS (where applicable).....	31
SWING-LEVEL GALLEY .....	31
HINGED GALLEY/STOVE CABINET .....	31
HINGED UPPER GALLEY .....	31
BAY WINDOW (where applicable) .....	32
TIP-OUT MODELS.....	32
GLIDE-OUT MODELS (where applicable).....	32
DINETTE .....	32
SCREEN DOOR .....	33
PULL-OUT SOFA BED (where applicable) .....	33
FRONT TRUNK STORAGE AREA.....	33
FRONT TRUNK LIGHTING .....	34
SHOWER .....	34
SHOWER CURTAIN .....	34
INSIDE SHOWER OPERATION .....	34
OUTSIDE SHOWER OPERATION (where applicable) .....	34
CASSETTE TOILET (where applicable) .....	35
TOILET (where applicable) .....	35
DUMPING THE HOLDING TANKS – BLACK/GRAY.....	35
HOLDING TANK CARE AND MAINTENANCE.....	36
RANGE/OVEN (where applicable) .....	36
INSIDE GALLEY STOVE USE.....	37
OUTSIDE STOVE USE (Optional).....	37
OUTSIDE STOVE.....	37
BBQ GRILL (Optional).....	38
FURNACE (Optional).....	39
REFRIGERATOR (Optional) .....	39
MICROWAVE OVEN (where applicable).....	39
AM/FM STEREO (where applicable).....	39
<b>TAKE-DOWN INSTRUCTIONS .....</b>	<b>40</b>
CRANK-DOWN STABILIZERS .....	42
SWING-DOWN STABILIZERS .....	42
CRANK-UP/CRANK-DOWN LIFT .....	42
<b>LIQUID PROPANE SYSTEM .....</b>	<b>43</b>
LIQUID PROPANE CYLINDER.....	44
LIQUID PROPANE CYLINDER REGULATOR.....	46
LIQUID PROPANE REGULATOR FREEZE-UP.....	46
LIQUID PROPANE LEAK DETECTOR.....	47
PROPANE SAFETY TIPS.....	47
<b>WATER SYSTEMS.....</b>	<b>48</b>
CITY WATER.....	48
WATER TANK.....	48
SINK DRAIN .....	49
+12 VOLT ELECTRIC DEMAND WATER PUMP .....	49
HOT WATER SYSTEM (where applicable).....	49
DRAINING AND WINTERIZING THE WATER SYSTEM.....	50
<b>CHASSIS SYSTEM .....</b>	<b>51</b>
TIRES .....	51
WHAT TO DO IF A FLAT TIRE OCCURS.....	52
BALL HITCH AND COUPLER.....	53
LUBRICATING/ADJUSTING WHEEL BEARINGS .....	53
<b>LIFT SYSTEM.....</b>	<b>54</b>

MAINTENANCE.....	54
TOP ADJUSTMENT .....	54
<b>TENT ENCLOSURE</b> .....	<b>55</b>
CLEANING.....	55
CONDENSATION PREVENTIVE MAINTENANCE.....	55
INFORMATION ABOUT MOLD AND IMPORTANT NOTICES .....	56
What Can the Owner Do? .....	56
VINYL BED END COVERS.....	57
MATTRESS CARE.....	57
<b>ROOF-MOUNTED ACCESSORIES</b> .....	<b>58</b>
ROOF-MOUNTED AIR CONDITIONERS.....	58
<b>ELECTRICAL</b> .....	<b>58</b>
CONVERTER.....	58
+12 VOLT ELECTRICAL CIRCUIT.....	59
110 VOLT AC POWER CIRCUIT.....	60
+12 VOLT EXTERIOR WIRING COLOR CODES .....	61
MAINTENANCE CHART .....	62
WINTER/OFF-SEASON STORAGE .....	64
<b>CHANGE OF OWNERSHIP NOTIFICATION</b> .....	<b>65</b>
<b>WEB SITE FOR F.F.T. (includes E-mail address) .....</b>	<b>www.fleetwoodrv.com</b>

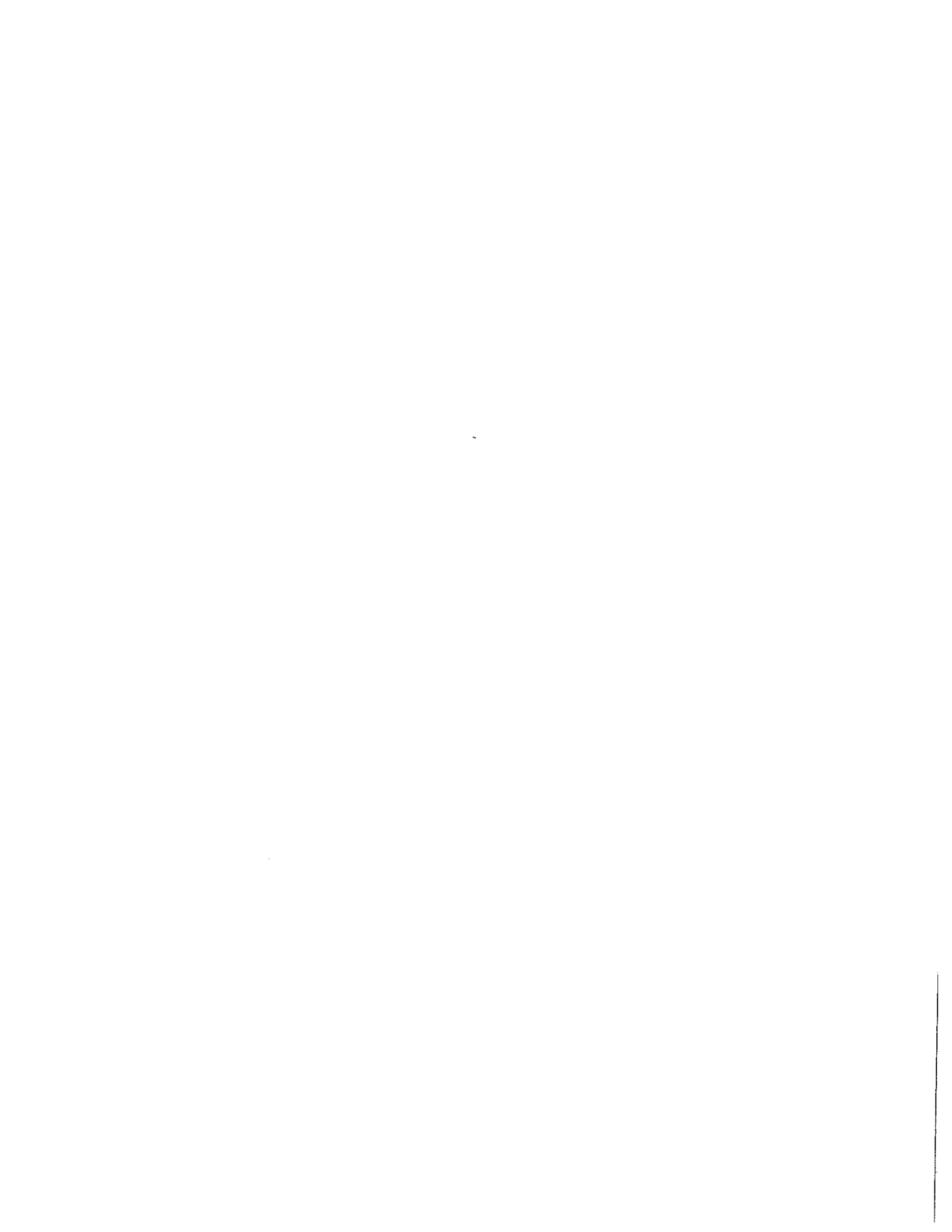

# INTRODUCTION

---

This manual contains important information regarding the safe operation and maintenance of your Fleetwood folding trailer. We urge you to read it carefully, understand all aspects of your trailer, and follow the recommendations to obtain the most trouble-free use of your recreational vehicle. Also included inside the trailer is owner information which contains very valuable documents that explain how to operate the major appliances, systems, and equipment built into your trailer. Warranty information on the various appliances and components in your trailer is also in this package. Fill out and mail any warranty registration cards for these items as soon as possible after you take delivery of your trailer. Since this owner's manual does not cover every possible detail of equipment and options installed on or in your trailer there are booklets and instructional material in the package that will help you operate, maintain, and troubleshoot those items. Be sure you read all this information. Keep it handy for reference. If you ever decide to sell or trade your trailer, be sure the new owner gets all the material in this package. In this manual, statements preceded by the following words are of special significance and we recommend that you take particular notice of these items when reading this manual:

**⚠ WARNING** Indicates a potentially hazardous situation which, if not avoided, could result in death or serious injury.

**⚠ CAUTION** Indicates a potentially hazardous situation which, if not avoided, may result in minor or moderate injury. It may also be used to alert against unsafe practices.

"**IMPORTANT**" means that there is a possibility of damage to the trailer if instructions are not followed.

"**NOTE**" indicates points of particular interest for more efficient and convenient operation.

**NOTE:** The words "shall" or "must" indicate a requirement that is essential to satisfactory and safe product performance. The words "should" or "may" indicate a recommendation or advice that is not essential and not required, but may be useful or helpful.

Please remember that when service is required, your Fleetwood folding trailer dealer knows your vehicle best. Consult him for any assistance you may require.

Illustrations in this manual represent function and may or may not be specific in their depiction of actual equipment, interior or exterior decor or design, and options as installed on or in your trailer. This product is designed for recreational use and short-term occupancy only. It is not designed nor intended to be used as permanent housing.

**Fleetwood Folding Trailers, Inc. reserves the right to change specifications, design, or material of its products at any time without notice or incurring any obligation to incorporate such changes in any product previously manufactured.**

## IDENTIFICATION INFORMATION

Your Name \_\_\_\_\_  
Trailer Model \_\_\_\_\_  
Serial No. \_\_\_\_\_  
Date Purchased \_\_\_\_\_  
Dealer Name \_\_\_\_\_  
Address \_\_\_\_\_

Refrigerator \_\_\_\_\_  
Manufacturer \_\_\_\_\_  
Model \_\_\_\_\_  
Serial No. \_\_\_\_\_

Furnace \_\_\_\_\_  
Manufacturer \_\_\_\_\_  
Model \_\_\_\_\_  
Serial No. \_\_\_\_\_

Water Heater \_\_\_\_\_  
Manufacturer \_\_\_\_\_  
Model \_\_\_\_\_  
Serial No. \_\_\_\_\_

Insurance Policy \_\_\_\_\_  
Agent Name \_\_\_\_\_  
Policy No. \_\_\_\_\_  
Agent's Telephone No. \_\_\_\_\_

Air Conditioner \_\_\_\_\_  
Manufacturer \_\_\_\_\_  
Model \_\_\_\_\_  
Serial No. \_\_\_\_\_

Water Heater \_\_\_\_\_  
Manufacturer \_\_\_\_\_

Miscellaneous \_\_\_\_\_  
Key No. \_\_\_\_\_

## IMPORTANT CONSUMER INFORMATION

---

### REPORTING SAFETY DEFECTS

If you believe that your vehicle has a defect that could cause a crash or could cause injury or death, you should immediately inform the National Highway Traffic Safety Administration (NHTSA) in addition to notifying Fleetwood Folding Trailers, Inc. If NHTSA receives similar complaints, it may open an investigation; and if it finds that a safety defect exists in a group of vehicles, it may order a recall and remedy campaign. However, NHTSA cannot become involved in individual problems between you, your dealer, or Fleetwood Folding Trailers, Inc. To contact NHTSA, you may either call the toll free Vehicle Safety Hotline toll free at 888/327-4236 (TTY: 800/424-9153); or go to <http://www.safercar.gov> or write to NHTSA, 400 7<sup>th</sup> Street SW, Washington, D.C. 20590. You can also obtain other information about motor vehicle safety from the Hotline.

To report safety defects in the provinces of Canada, those residents should notify Road Safety and Motor Vehicle Regulation Directorate of Transport Canada, 2780 Sheffield Road, Ottawa, Ontario K1B 3V9 (800/333-0510).

### NOTICE TO DEALER AND CONSUMER

Because brake requirements are governed by state or provincial regulation, the requirements vary widely. To ensure compliance with applicable regulations, we recommend you check with your Department of Motor Vehicles or Road Safety & Motor Vehicle Regulations Directorate of Transport Canada to determine if brakes are required on your trailer. Fleetwood Folding Trailers provides electric brakes as standard equipment on all trailer models. However, your state or province will define the compliance regulations. Read all corresponding brake manuals associated with the installation of electric brakes or brake controllers. If you did not receive the appropriate brake manuals, you may contact Dexter Axle Division at 222 Collins Road, Elkhart, Indiana 46516 (Phone: 574/295-1900), Fleetwood Folding Trailers at 258 Beacon Street, Somerset, Pennsylvania 15501 (Phone: 814/445-9661), or your local authorized dealer.

# **2007 FLEETWOOD FOLDING TRAILER LIMITED WARRANTY**

---

## ***SUMMARY OF WARRANTY***

Fleetwood Folding Trailers, Inc. extends to the original retail purchaser a warranty against functional defects in material and workmanship subject to the terms and conditions as listed. Please read carefully.

## **DESTINY, AMERICANA, EVOLUTION, HIGHLANDER, AND ELEMENT SERIES**

One Year General Warranty	<b>Parts, Labor, and Freight Power Lift Components</b>
Five Year Warranty	<b>Roof Assembly</b> Year One: Parts, Labor, and Freight Year Two and Thereafter: Parts and Labor
	<b>Tent Material</b> Year One: Parts, Labor, and Freight Year Two and Thereafter: Parts Only
Twenty-Five Year Warranty	<b>Floor and Bed Wood</b> Year One: Parts, Labor, and Freight Year Two - Five: Parts and Labor Year Six - Twenty-five: Parts Only
Lifetime Warranty	<b>Lift System and Trailer Frame</b> Year One: Parts, Labor, and Freight Year Two and Thereafter: Parts and Labor

---

During the specified times, any defective parts in a Fleetwood folding trailer will, at Fleetwood's option, be either repaired or replaced on an exchange basis with new or reconditioned parts. This Warranty does not cover the expense to deliver the folding trailer to the dealer for repair, nor the return expense. It is the consumer's responsibility to pay all expenses incurred in obtaining warranty performance other than those specifically provided for in this Warranty.

**This warranty is to the original purchaser and is not transferrable.**

The date of retail sale is established by the Warranty Registration.

Replacement parts are warranted for the unexpired duration of the original warranty.

To obtain warranty performance: Consult the yellow pages of the telephone book under "Recreational Vehicle Dealers" for the name, address, and telephone number of the nearest authorized Fleetwood folding trailer dealer; call Fleetwood Folding Trailers, Inc. at 814/445-9661 or E-mail us at [www.foldingtrailers.com](http://www.foldingtrailers.com). (Sorry, collect calls cannot be accepted.) Call the authorized Fleetwood folding trailer dealer, report the problem and schedule an appointment. Take the trailer at the scheduled time to the dealer along with the owner's card given to you by your dealer. Only authorized Fleetwood folding trailer dealers may perform warranty obligations. The authorized Fleetwood folding trailer dealer will advise when the warranty performance has been completed. All payments for warranty service and for parts will be made by Fleetwood to the dealer and not to the consumer.

**NOTE:** Recreational vehicles are built for temporary living and are not designed as permanent dwelling places.



## LIMITED WARRANTY GENERAL EXCEPTIONS AND EXCLUSIONS

To the extent any or all of the following exclusions or provisions of this warranty are prohibited by any federal, state, or municipal law which cannot be preempted, those exclusions or provisions shall not be applicable.

THERE ARE NO OTHER EXPRESS WARRANTIES EXCEPT THOSE NOTED IN THE SUMMARY OF WARRANTY SECTION OF THIS MANUAL AND ANY IMPLIED WARRANTIES, INCLUDING THE IMPLIED WARRANTIES OF MERCHANTABILITY AND FITNESS FOR A PARTICULAR PURPOSE, ARE LIMITED IN DURATION TO THAT OF THE EXPRESS WARRANTY. Some states do not allow limitations on how long an implied warranty lasts, so the above limitation may not apply to you.

The installation of any roof-mounted accessories exceeding 150 pounds, alterations to the lift system, any damage caused by improper maintenance, improper repair, or the use of improper repair parts are not covered under this warranty. The lifetime warranty provisions do not include exterior surface finish, frame paint, axle beam, springs, running gear components, bed extensions, bed frames, damage due to installation of non-standard roof equipment, or exceeding the recommended top/trailer cargo limits.

Any cosmetic and non-functional defects not noted prior to retail delivery are not covered under this warranty.

Any unauthorized repairs.

Damage caused to floor and bed wood from excessive moisture.

Damage caused by failure to perform normal and routine maintenance as set out in the folding trailer owner's manual, mishandling, neglect, abuse, misuse, wind, lightning, hail, or corrosive atmospheres are not covered by this warranty.

This warranty shall not apply if the serial number plate is removed or defaced.

The tent material is not warranted against mildew, mold, fading, discoloration, or soiling. Rips and tears not noted prior to retail delivery are not warranted.

Damage caused by traveling over unimproved roads.

Vinyl floor covering gouges, cuts, or tears, not noted prior to retail delivery, are not covered under this warranty.

Service calls for warranty work are not covered.

The water heater, cassette potti, furnace, refrigerator, and other appliances in trailers so equipped, are warranted by their respective manufacturers. A copy of the warranty for each of these components is provided with the folding trailer. The light bulbs, fuses, tire valve cores, and other similar items are not covered by this warranty and are sold AS IS.

Trailers used for rental purposes are covered by this warranty for three (3) months from the date of purchase by the rental dealer; or if rented by an authorized Fleetwood folding trailer dealer, from the date of rental registration.

This warranty applies only to products sold at retail in the United States and Canada.

Fleetwood Folding Trailers, Inc. reserves the right to make changes in the design or material of its product without incurring any obligation to incorporate such changes in any product previously manufactured.

**THIS WARRANTY DOES NOT COVER CONSEQUENTIAL DAMAGES OR CHARGES**, such as extra expenses for transportation to and from the dealer or manufacturing plant location, loss of time, loss of pay, loss of use of the folding trailer, inconvenience, commercial loss, towing charges, bus fares, vehicle rental, incidental charges such as

telephone calls or lodging bills, or other INCIDENTAL CHARGES, DAMAGES, OR EXPENSES INCLUDING DAMAGE TO PROPERTY. Some states do not allow the exclusion or limitation of incidental or consequential damages, so the above limitation or exclusion may not apply to you. This warranty gives you specific legal rights, and you may also have other rights which vary from state to state.

Fleetwood will NOT be responsible for any other losses, damages, or claims, including, but not limited to, property damage, personal injury, loss of income, legal fees or expenses, emotional distress, death, loss of use, loss of value, all other economic loss, adverse health effects, or any other effects caused or alleged to be caused by MICROBIAL MATTER, including, but not limited to, mold, mildew, fungus, or dry rot.

THE IMPLIED WARRANTIES ARE LIMITED IN DURATION TO THE EXPRESS TERMS OF THIS ONE YEAR WARRANTY.

## PRE-TRIP PREPARATIONS

---

Before you seek out those favorite recreational campsites with your new Fleetwood folding trailer, we suggest you first make these pre-trip preparations. Read the information in this booklet very carefully. Please note that the text for the set-up and take-down instructions does not differentiate between models. When the text does not apply to your model, continue to the next applicable step. Set up and take down the trailer per the instructions several times to familiarize yourself completely with the procedure and to prevent unintentional damage to the equipment.

Establish a tool kit for your trailer's maintenance needs and stow it in your tow vehicle. The tool kit should include good quality items such as a standard slot screwdriver, standard Phillips screwdriver, pliers, hydraulic or scissor jack (2 ton), 13/16" lug wrench (furnished), stabilizer jack handle (furnished), crankshaft handle (furnished), torque wrench, and four wheel chocks and leveling blocks capable of handling the trailer weight.

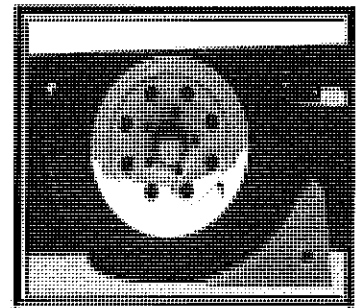

**Wheel Chock**

Final preparations should include the proper loading and physical check of the trailer before the trip. The trailer should be loaded with these basic rules in mind:

1. Keep your trailer as light as possible. Reducing cargo weight will increase gas mileage. Distribute all cargo and accessory weight as evenly as possible. **Be certain that a minimum of 10% to 15% of the overall trailer weight is on the ball hitch of the tow vehicle. Less than 10% will result in a negative tongue weight which can cause whipping or swaying while towing.**
2. Water tanks do not need filling unless primitive camping is planned; fill water tanks at the campground to reduce towing weight.

Make your first trip close to home if possible. This will serve as a preparatory trip to see that everything works and what other items you will need to take. A physical check should also be made per this checklist. Be certain that:

1. Tires are inflated to the recommended pressure as indicated on the tire sidewall. The three main causes for early tire wear and/or premature tire failure are under inflation, over loading (cargo), and improper towing (see towing section). Always check the tire air pressures before towing the trailer. Temperature changes can result in loss of tire air pressure. See the Trailer Weight Information Decal located inside the trailer for your trailer's proper cargo capacities.

**NOTE:** If the original trailer tires are replaced with aftermarket passenger car tires, the consumer must deduct 10% of the stated maximum load carrying capacity of the tires to determine the actual Gross Vehicle Weight Rating (GVWR) applicable for trailer use.

**⚠WARNING**

All trailer tires should be the same type, size, and construction. Do not mix bias-belted and radial tires.

2. Wheel lug nuts are properly torqued using a calibrated torque wrench. Check torque before your first trip, after each wheel removal, and thereafter at 10, 25, and 50 mile intervals. Re-torque at every 1,500 miles thereafter. Please reference the "Wheel Torque Requirement" chart on page 53. For lug nut torque sequence, see "How to Change a Flat".

**⚠WARNING**

Failure to follow the recommended retorquing sequence can cause tire disengagement that could result in loss of vehicle control.

3. Hitching up a trailer is recommended to be done with a two person team, one to drive the vehicle and one to spot the hitch and trailer.

**NOTE:** The trailer should be on flat, level ground with wheels chocked to prevent unintentional movement of the trailer.

4. The trailer coupler is securely latched (visual check) to the tow vehicle's ball hitch with safety pin in place.
5. Extend the tongue jack to the ground and lift the tow vehicle/trailer combination 2" - 4" to ensure the coupler is securely attached. Retract the tongue jack to its travel position.
6. The safety chains are securely attached with the quick couplers to the trailer chassis and tow vehicle hitch (chains must crisscross).
7. The +12 volt folding trailer electrical pigtail is connected to the tow vehicle's matching +12 volt pigtail.
8. All lights on the trailer are functioning properly.
9. The liquid propane cylinder valve is closed and propane cylinder is secured to the chassis mounting brackets.
10. The cooler and other cargo items are securely held in place.
11. All trailer doors and latches are securely fastened and locked.

**⚠WARNING**

Do not store or carry propane containers, gasoline, or flammable liquids inside your trailer. Fumes or liquid exposed to an open flame can ignite and cause a fire or explosion.

We hope you read and follow this information and the helpful hints very closely. If you do, you will receive the maximum benefit from your Fleetwood folding trailer.

# TOWING GUIDELINES

---

## TOWING REQUIREMENTS: Tow Vehicle, Towing Package, and Trailer

### TOW VEHICLE

Qualify your tow vehicle to be sure it has enough towing capacity, horse power, braking capability, and appropriate towing equipment package. Ask yourself the following questions about your vehicle:

- What is the model year?
- What is the make and model?
- Is it a passenger vehicle, station wagon, truck or van?
- Does it have two or four doors (where applicable)?
- Does it have a manual or automatic transmission?
- What is the vehicle's maximum towing capacity?
- Is it two-wheel drive or four-wheel drive (where applicable)?
- What is the engine size (3.3 V-6, 3.8 V-6, etc.)?

Once these basic questions are answered, you can double-check the towing capacity by referencing published towing guides such as Trailer Life<sup>®</sup> and Woodall's<sup>®</sup>. Your local authorized brand name Ford, General Motors, Chrysler, etc., dealer can also verify your towing capacity for you. Specific brand name manufacturers often require tow vehicles to have upgrade equipment prior to towing. See the following sample.

#### 2005 ANY BRAND/MODEL VEHICLE

**SAMPLE ONLY**

<u>Vehicle</u>	<u>Engine</u>	<u>Tow Limit (lbs.)</u>
Model 1	3.3 V-6	2,000 a, g
Model 2	3.8 V-6	2,000 b, d
Model 3	3.8 V-6	3,000 b, d, f

NOTE: Hitch weight should be ten percent of the loaded trailer weight without exceeding rating specified by the folding trailer manufacturer.

- a - Requires a 2.73:1 axle ratio
- b - Requires a 3.06:1 axle ratio
- c - Requires a 2.79:1 axle ratio
- d - Requires a V92 towing package
- e - Class III frame-mounted hitch
- f - Weight-distributing hitch
- g - Auxiliary oil cooler

(There may be other possible requirements based on the model and make of tow vehicle.)

### HITCHES\*

#### Weight-Carrying Hitches

To understand weight-distributing hitches, it is useful to review weight-carrying hitches. Weight-carrying hitches simply support the trailer tongue weight at the rear of the tow vehicle as though it were luggage in the trunk, except located farther to the rear. The additional load supported by the tow vehicle's rear axle is greater than the tongue weight itself. The load on the tow vehicle's front axle is reduced by the same amount that the load on the rear axle is increased. For many vehicles, the rear overhang is about half as long as the wheelbase. For this situation, the load

on the rear axle is increased by 1.5 x the tongue weight, and the load on the front axle is decreased by 0.5 x the tongue weight. The total increase in axle loads is exactly equal to the tongue weight.

With weight-carrying hitches, the tongue weight tends to cause the tow vehicle to squat at the rear and rise at the front.

### Weight-Distributing Hitches

Weight-distributing hitches (sometimes called “equalizing” hitches) apply leverage between the tow vehicle and trailer to redistribute the trailer’s tongue weight among all the axles of both vehicles. The tow vehicle rides more level, and carries less of the trailer’s tongue weight directly on the ball hitch.

Most weight-distributing hitches use a pair of spring bars to introduce leverage between the tow vehicle and trailer. The front ends of the spring bars are attached to the tow vehicle through the hitch. Other than the fact that the spring bars can usually pivot about a vertical axis, they may be thought of as a pair of wheelbarrow handles attached to the tow vehicle. The rear ends of the spring bars are attached to the trailer tongue by a pair of brackets and/or chains. When the trailer attachments pull up on the ends of the spring bars, leverage is introduced between the trailer and the tow vehicle. This changes the weight distribution between the two vehicles.

Upward forces on the rear ends of the spring bars tend to lift the rear and lower the front of the tow vehicle. These same forces react on the trailer frame, and result in an increase in the reaction between the trailer’s coupler and the ball, and also in an increase in the trailer’s axle load. The tow vehicle’s rear axle load is reduced, while the front axle’s load is increased. The effect of this leverage tends to level the tow vehicle.

Note that the tow vehicle carries less than the trailer’s tongue weight. However, the trailer axle load is increased compared to the weight-carrying case.

The changes in axle loads and the total amount of tongue weight carried by the tow vehicle depend on the following:

- The trailer’s tongue weight
- The amount of leverage introduced by the spring bars
- The tow vehicle’s wheelbase and overhang
- The distance from the hitch ball to the center of the trailer’s axle(s)

Choose the proper hitch: The two most important factors in selecting towing equipment are the Gross Trailer Weight (GTW) or Gross Vehicle Weight Rating (GVWR) and the Tongue Weight (TW).

<b>SAMPLE ONLY</b> Locate the type of tow vehicle and trailer you intend to tow and follow the columns until they intersect to identify the type of hitch you will need.	<b>Light Duty Class I</b>	<b>Medium Duty Class II</b>	<b>Heavy Duty Class III</b>
		Up to 2,000 lbs. GTW Up to 200 lbs. TW	Up to 3,500 lbs. GTW Up to 350 lbs. TW
<b>Compact Car</b>	Class I Light-Duty Hitching System	Not Recommended For Towing	Not Recommended For Towing
<b>Mid-Size Car</b>	Class I Light-Duty Hitching System	Class II Medium-Duty Hitching System	Not Recommended For Towing
<b>Full-Size Cars Mini-Trucks &amp; Vans</b>	Class I Light-Duty Hitching System	Class II Medium-Duty Hitching System	Class III Heavy-Duty Hitching System
<b>Full-Size Vans Trucks &amp; Utility</b>	Class I Light-Duty Hitching System	Class II Medium-Duty Hitching System	Class III Heavy-Duty Hitching System

**GTW** Gross Trailer Weight      **WD** Weight Distributing  
**TW** Tongue Weight              **WC** Weight Carrying

**NOTE:** This chart is a general guide and the specific weights and capacities of the actual trailer, tow vehicle, and available hitch must be known in each case. Some trailers may require additional towing equipment such as a weight distributing hitch or an anti-sway device, depending on your specific tow vehicle's recommendations.

For details on hitch recommendations, contact your local authorized folding trailer dealer.

**⚠ WARNING**

Do not overload any part of your towing system. Do not modify any portion of your towing system. Only use your towing system for its intended purpose. Failure to heed warnings may result in a vehicle accident, property damage, and personal injury.

**TRAILER**

As with your tow vehicle, ask yourself the following questions about your trailer. This will confidently enable you to match the tow vehicle and hitch to your trailer.

- What is the trailer type?
- What is the Gross Vehicle Weight Rating (GVWR)?
- What is the tongue weight?
- What is the coupler socket size or ball hitch size? (2")
- Does it have safety chains installed or are new ones required?

- Where do you do most of your towing (flat level roads, mountainous terrain, etc.)?
- Is there an auxiliary +12 volt battery installed on the trailer?

By asking yourself these and other pertinent questions pertaining to your towing system, you will be able to safely and effectively tow your new trailer. If you cannot answer any of the above questions, contact your local authorized folding trailer dealer for assistance immediately.

## TOWING

It's of utmost importance to keep the loaded trailer as level as possible when hooked to the tow vehicle's hitch. To check for levelness, latch the trailer to the tow vehicle. Place a small level atop the A-frame chassis, running front to rear on the main frame bar. Check bubble level indicator; if the bubble indicator does not indicate level, adjust one end or the other of the level until the bubble indicates level. The tow vehicle or hitch must be adjusted to obtain a level reading while connected to the tow vehicle. Use the level to monitor the adjustment on the trailer hitch and tow vehicle until level is indicated on the bubble window. The trailer tongue should be within 1" of level (above or below level) at all times before attempting to tow the trailer. Towing a trailer with the tongue inclined will cause premature tire wear. This is also found to be true if the tongue area is angled downward. Even if you've towed before, you'll want to get the feel of maneuvering any new vehicle or trailer, so practice starts, stops, parking, braking, and turning. When driving, always check the traffic clearance before pulling out from the curb or shoulder into the main traffic flow.

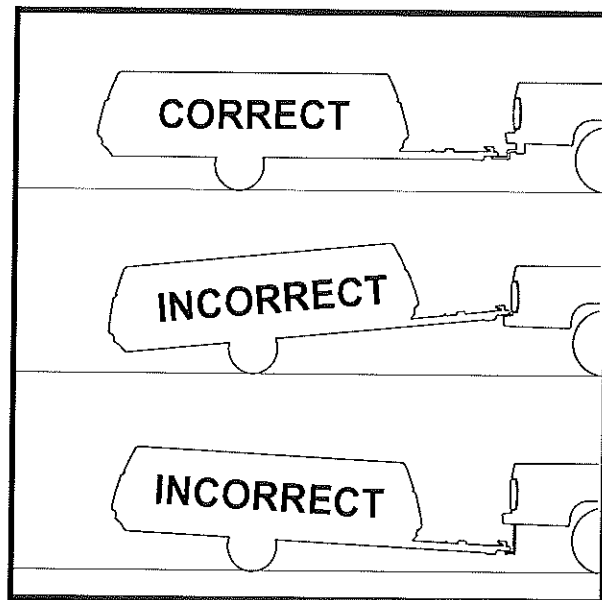

### **⚠ WARNING**

Do not install any type of weight carrying rack, frame, or hitch to the rear bumper, front A-frame assembly, chassis, or body component of the trailer unless specified by the trailer manufacturer. Damage to the trailer body and/or unstable handling characteristics may result. Add-ons to the rear bumper, front A-frame assembly or the chassis could void your warranty on structural components unless specified by the trailer manufacturer.

**IMPORTANT:** Towing a trailer attached to a step bumper may interfere with or limit your turning radius. Trailers equipped with front storage compartments have a smaller turning radius.

**IMPORTANT:** If you are towing a trailer that is wider than your tow vehicle, you will need extended side view mirrors to see rear and side approaching traffic.

For turns, pull past your turn or intersection sufficiently before turning so as not to run into the curb or obstructions. The longer your trailer, the further past the turn you must pull for clearance. Most new owners are surprised at how well Fleetwood folding trailers track and how little additional maneuvering space is required, but don't let this cause you to forget it's behind you. During parking or backing, remember that the rear of the folding trailer moves opposite to the rear of the towing vehicle. Start by simply placing your hand on the bottom of the steering wheel, then moving your hand left (wheel turning right) will move the trailer to the left and vice versa. On the road, maintain a safe driving distance from other vehicles. **A safe driving distance is the total length of your towing vehicle and folding trailer combined for each ten miles per hour of speed.**

If trailer sway is encountered while towing:

- Steer as little as possible while maintaining control of the vehicle. Because of your natural reaction time lag, quick steering movements to counter trailer sway will actually cause increased sway and loss of control. Try to hold the wheel as straight as possible until stability is regained.
- Slow down but avoid strong tow vehicle braking. Reduce speed gradually whenever possible. If your tow vehicle is equipped with an electric brake controller, use the hand control to gradually apply the trailer brakes; this will help keep the vehicles aligned. Tow vehicle braking reduces trailer stability, and sliding tow vehicle tires can cause loss of control and jackknifing.

If a reduction in trailer stability has occurred, slow down immediately and stop as soon as possible. Check tire pressures, sway control adjustment, hitch spring bar adjustment, cargo weight distribution, and look for any signs of mechanical failure. Until the problem has been identified and corrected, travel at reduced speeds that permit full control.

When approaching a downhill grade, downshift, letting the engine compression act as a brake. Should you need added braking, apply your brakes as required. When approaching an uphill grade, the answer is the same - downshift. This keeps the engine from lugging down which may overheat from laboring in a higher gear. Your towing equipment, its adjustments and how you load the trailer will have a great effect on trailer towing stability and handling. ***Be sure to use a tow vehicle that is large enough for your trailer and has the needed power and appropriate towing equipment package.*** Hitching up your trailer will become routine with experience. Make it a habit to examine all hitch components before hitching the trailer. Check for cracked or bent parts, cracked welds, and deformed or stripped bolts. Be sure the hitch ball is tight and well lubricated. Inspect the safety chains. If you find defects in any hitch component, correct it before towing the trailer.

## **BRAKE SYSTEM (where defined by state or provincial regulations)**

The electric brakes on your trailer are similar to the drum brakes on many cars and trucks. The basic difference between them is that your trailer brakes are operated by +12 volt DC power from the tow vehicle, rather than by hydraulic action. During break-in, they may squeak; this is normal and should cease after a few miles of use. The brake system on your trailer consists of several major components, all of which must function properly for safe braking.

**TOW VEHICLE BATTERY:** The tow vehicle is the electrical power source for the trailer braking system by supplying +12 volt to the dash-mounted brake controller. The connection is made at the positive post of the battery, or at the tow vehicle starter solenoid battery terminal.

**BRAKE CONTROLLER:** The brake controller is not supplied with your trailer. The electric trailer brakes are applied by the brake controller, which should be mounted within easy reach of the driver. This controller is connected to the tow vehicle's brake system and is actuated whenever the tow vehicle's brakes are applied. It may also be used to manually apply the trailer's brakes to control sway. The controller should have an adjustment for its engagement point (synchronization); it is best to have the trailer brakes start acting slightly before those of the tow vehicle. This is called brake "lead". This causes the trailer to pull against the tow vehicle, keeping the two vehicles in alignment. This is particularly important during rainy weather or whenever the road surface is slippery. If the tow vehicle sets its brakes first, the trailer will tend to push the tow vehicle and possibly "jackknife". You may also need a resistor in the +12 volt system to keep trailer braking force low enough to prevent wheel lockup. Consult your specific brake controller instructions for further information and wiring instructions.

**NOTE:** The brake controller is not supplied by the trailer manufacturer.



**⚠ WARNING**

Do not install a fuse in the circuit between the tow vehicle battery and the brake controller. A blown fuse would cause the controller to cease operating both automatically and manually, causing loss of trailer braking with no advance warning.

**CONNECTOR PLUG:** The +12 volt trailer end plug connector at the front of the trailer transfers electrical power from the tow vehicle's battery to the trailer brakes, exterior lighting system, and optional battery if equipped. Keep the plug clean, tight, and protected from the elements. Inspect it carefully every time you hitch up for a proper connection.

**TRAILER BATTERY:** The auxiliary trailer battery provides power to activate the trailer brakes in case of an emergency where the trailer becomes unhitched during towing.

**NOTE:** The battery is not supplied by the trailer manufacturer.

**BREAKAWAY SWITCH:** The breakaway switch is located on the trailer tongue. It has a steel cable (lanyard) fastened to it which will reach to a non-removable part of the tow vehicle. This device is one of the most vital components on your trailer's braking system. It automatically applies the trailer brakes if the tow vehicle and trailer become uncoupled while in motion. The breakaway switch operates when a pull pin linked by the cable to the tow vehicle is separated from the switch. When the switch closes, power for brake application is transferred to the auxiliary trailer battery. The steel lanyard must be anchored to the tow vehicle when the trailer is hitched up. Secure this cable loop to the permanent frame of the tow vehicle, or a part of the hitch that is non-removable. ***Do not fasten the breakaway switch cable (lanyard) to the hitch ball or any other removable part of the hitch.*** Remove the pull pin every three months and lubricate it with light oil. Before reinserting the pin, spray the inside of the switch with an electrical contact cleaner to prevent corrosion.

Test the breakaway switch operation before each trip as follows:

1. Hitch the trailer to the tow vehicle on a level surface.
2. Pull out the breakaway switch actuating pin.
3. Test brakes by attempting to drive away slowly. The breakaway switch is functioning properly if both left and right trailer brakes are activated while pulling forward slowly.
4. If both brakes are not activated, check that the auxiliary trailer battery is connected and fully charged, and that both trailer brakes are properly adjusted.
5. Obtain service repair if the trailer brakes do not operate after making these checks.
6. Reinsert the breakaway switch actuating pin before towing the trailer.

**⚠ WARNING**

Do not tow a trailer with a malfunctioning breakaway switch.  
Do not leave the pull pin out of the breakaway switch for more than a few minutes or the battery will be drained.  
Do not use the breakaway switch for a parking brake.

**TRAILER BRAKES:** Your trailer brakes are actuated by electrical energy from the brake controller. The greater the braking effort from the brake controller, the greater the braking force applied to the trailer brakes. Brakes should be adjusted after the first 200 miles and at 3,000 mile intervals, or as use and performance requires. For brake adjustment and maintenance, please refer to Dexter's electric brake manual supplied in the trailer information packet.

**GROUNDING:** The electrical circuit that operates your trailer brakes can be reliably completed only by proper grounding back to the tow vehicle. **A poor ground circuit from the trailer brakes to the tow vehicle battery can**

hurt braking performance as much as a poor primary circuit from the battery to the brakes. Do not rely on the hitch ball/coupler for a good ground. The tow vehicle connector plug should supply an adequate ground.

## BRAKING TIPS

Before moving your trailer, inspect all external braking system components for proper function. Inspect all wiring connections. Test the breakaway switch as outlined.

Never use the trailer brakes alone for extended periods. They are designed to stop the trailer, not the tow vehicle. This action places excessive loads on the brakes, causing overheating, fading, and premature wear.

Never use the tow vehicle brakes alone. The added weight of the trailer will increase the load on the tow vehicle brakes, causing overheating, fading, and premature wear. Driving control can also be affected due to the force of the trailer pushing against the tow vehicle. On slippery road surfaces this can result in “jackknifing”.

Always use the brake controller. This synchronized braking system allows you to drive in the manner recommended by experts, both hands on the steering wheel. The brake controller is properly adjusted when the trailer brakes slightly “lead” the tow vehicle brakes. This will help keep the vehicles aligned for a safe, straight stop.

## WEIGHING YOUR TRAILER

**IMPORTANT:** We recommend weighing your trailer periodically to ensure that the weight limitations of the trailer are not exceeded. To determine specific weights of your Fleetwood folding trailer, follow these procedures using a platform scale such as those used by trucking companies or highway weigh scales.

**GROSS VEHICLE WEIGHT (GVW):** Once you have loaded your trailer for camping, pull the trailer onto the scale, lower the tongue jack, and disconnect the trailer from tow vehicle. Move tow vehicle off of the scale. Both the trailer axle and tongue jack must be on the scale. The measured weight of the loaded trailer must not exceed the Gross Vehicle Weight Rating (GVWR) of the trailer. Cargo or equipment must be removed until the GVWR is not exceeded.

**GROSS AXLE WEIGHT (GAW):** Position the trailer so that it is level and only the axle rests on the scale. Ensure the tongue jack is off the scale.

**TONGUE WEIGHT (TW):** Position the trailer so that only the tongue rests on the scale. The tongue weight must be 10% to 15% of the Gross Vehicle Weight for best towing results.

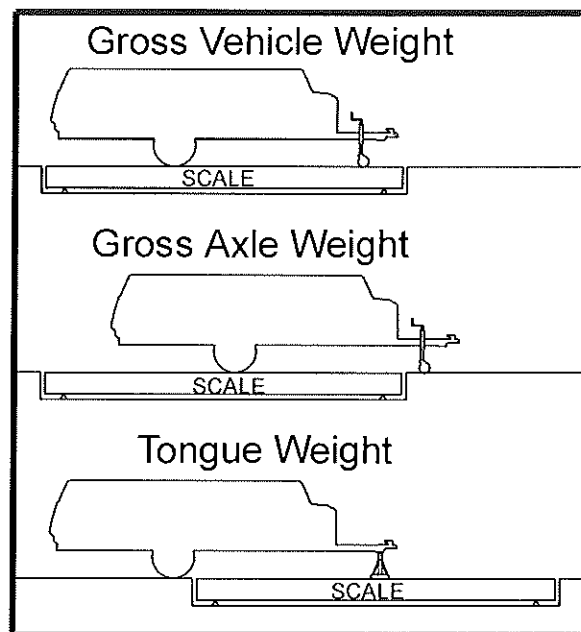

## DEFINITIONS OF TRAILER WEIGHTS, RATINGS, AND TERMS

**UNLOADED VEHICLE WEIGHT (UVW)** - Weight of this trailer as manufactured at the factory when separated from the tow vehicle. The UVW does not include the weight of water in the storage tank or water heater (if applicable) or propane in the propane bottle.

**GROSS AXLE WEIGHT RATING (GAWR)** - Maximum permissible loaded weight this trailer’s axle is designed to carry.

**GROSS VEHICLE WEIGHT RATING (GVWR)** - Maximum permissible weight of this trailer fully loaded for camping when separated from the tow vehicle including: all accessories, fluids, and cargo. GVWR equals GAWR + Tongue Rating.

**GROSS COMBINATION WEIGHT RATING (GCWR)** - The value specified by the tow vehicle manufacturer as the maximum allowable loaded weight of the tow vehicle with its towed trailer.

**CARGO CARRYING CAPACITY (CCC)** - The CCC is equal to the GVWR minus the following: UVW, full fresh water tank weight (including water heater if applicable), and full propane bottle.

**TONGUE RATING:** Maximum rated weight-carrying capacity of the coupler equipped with this trailer.

**NOTE:** Cargo weight will include all camping equipment and supplies, installed accessories, and fluid (propane, water).

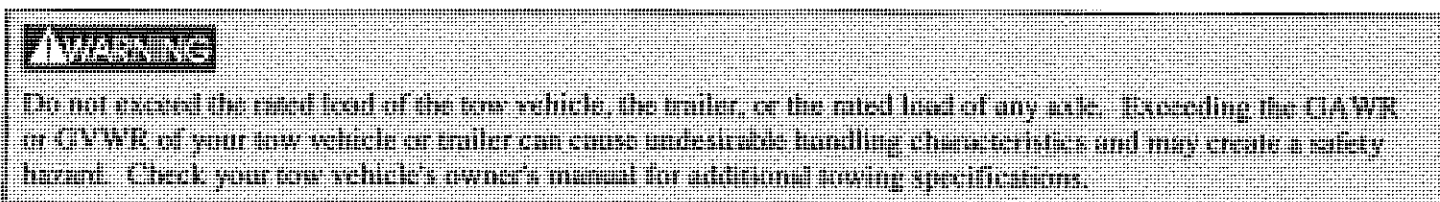

Following is a sample Trailer Weight Information Decal. **The decal for your specific model will be in your trailer.** Trailer weights listed on the Trailer Weight Information Decal are subject to 5% variation due to raw materials. Some accessories listed in this manual may be standard equipment on your trailer; others may have been installed by your selling dealer. Please check the trailer weight information decal and with your dealer before any calculations are performed to determine the Net Carrying Capacity (CCC).

To calculate the available Cargo Carrying Capacity (CCC) with full propane cylinder and a full water tank, these weights must be added to the Dry or Unloaded Vehicle Weight (UVW) first. \* Water weighs 8.345 pounds per gallon.

<b>EXAMPLE:</b>	Propane in one bottle (80% full)	22 lbs.	
	10 gallons water *	<u>+ 83 lbs.</u>	
	Total fluid weight	105 lbs.	
	GVWR	2,550 lbs.	
	UVW (includes fluids & propane)	<u>-1,770 lbs.</u>	(1,665 + 105)
	Available cargo weight for transit	780 lbs.	

## WARNING TRAILER WEIGHT INFORMATION:

MODEL CHEYENNE	YEAR 2005	MODEL NO 3776
VIN	TYPE	

GVWR:	3,000 lbs.	1,361 kg
GAWR:	2,650 lbs.	1,202 kg
UVW:	2,645 lbs.	1,202 kg
CCC:	424 lbs.	192 kg

### CARGO CARRYING CAPACITY (CCC) CALCULATION:

GVWR	minus UVW	935 lbs.	424 kg
	minus fresh water weight of 20 gallons @ 8.3 lbs/gal	760 lbs.	345 kg
	minus water in water heater: 5 gallons @ 8.3 lbs/gal	718 lbs.	326 kg
	minus LP gas weight of 4.7 gallons @ 4.2 lbs/gal	696 lbs.	315 kg
	CCC for this trailer*	424 lbs.	192 kg

\* Dealer Installed equipment will reduce CCC. Customers should request this information from the dealer. All weights and capacities are approximate.

**GVWR (Gross Weight Vehicle Rating)** is the maximum permissible weight of this trailer when fully loaded. It includes all weight at the trailer axle and tongue or pin.

**GAWR (Gross Axle Weight Rating)** is the maximum permissible loaded weight this trailer's axle is designed to carry.

**UVW (Unloaded Vehicle Weight)** is the weight of this trailer as manufactured at the factory. It includes all weight at the trailer axle and tongue or pin. If applicable it also includes full generator fluids, including fuel, engine oil and coolants.

**CCC (Cargo Carrying Capacity)** is equal to the GVWR minus each of the following: UVW, full fresh potable water weight (including water heater), and full LP gas weight.

### CONSULT OWNER MANUAL(S) FOR SPECIFIC HITCHING AND WEIGHING INSTRUCTIONS AND TOWING GUIDELINES

To make sure that you get the maximum satisfaction out of your recreational vehicle purchase, there are several things you should know:

1. Learn all you can about the folding trailer you are planning to purchase. Do not rely on word of mouth. Get the facts about the actual trailer length, width, Unloaded Vehicle Weight, Gross Vehicle Weight Rating, Gross Axle Weight Rating, and Cargo Carrying Capacity. Be sure to check this information **BEFORE** you decide which unit to buy.
2. Verify the towing capacity of your tow vehicle. If you do not know or are not sure, you can ask at your automotive dealership. Be sure to match its tow rating to the loaded (not dry) weight of your trailer. Include the weight of water, additional accessories, clothing, food, and gear. To help Fleetwood folding trailer customers estimate this total weight, our Gross Vehicle Weight Rating reflects the actual weight of the trailer when fully loaded for camping.

Taking these simple steps before you buy will help insure that your trailer is just what you wanted. You will also have the peace of mind of knowing that your tow vehicle will be adequate to get you there.

FC-010

All weights and liquid capacities are subject to change. For actual GVWR, refer to the vehicle identification tag located on the front driver's side body panel of the trailer.

**IMPORTANT:** Optional accessories added to the trailer must also be added to the Dry or Unloaded Vehicle Weight (UVW) when calculating Cargo Carrying Capacity (CCC). Check with your dealer to determine what items were standard equipment on your trailer. It is **not recommended** to install accessories to the rear of the trailer frame. Adverse towing characteristics could occur due to light tongue weight.

## APPROXIMATE WEIGHTS OF COMMON ACCESSORIES

The following weights, if installed on your unit, must be added to the Unloaded Vehicle Weight (UVW) and are to be considered as a portion of Cargo Carrying Capacity (CCC):

<u>Accessory</u>	<u>Weight</u>	<u>Accessory</u>	<u>Weight</u>
Molded tire cover	6 lbs.	Molded propane bottle cover	6 lbs.
Outside stove	20 lbs.	Auxiliary battery	60 lbs.
Vanity mate	8 lbs.	BBQ Grill	20 lbs.
Camper caddie	4 lbs.	Wardrobe rack	5 lbs.
Cargo basket	18 lbs.	Grey water storage tank with rack (non-tub models except Tucson)	40 lbs.
Grey water storage tank with rack (Tub models only)	43 lbs.	Refrigerator/kit	65 lbs.
Drain hose kit	4 lbs.	Double cross bar kit	24 lbs.
Screen room, 8' model	14 lbs.	Power lift ball-bearing screw	12 lbs.
Screen room, 10' model	15 lbs.	Furnace & kit	40 lbs.
Screen room, 12' model	16 lbs.	Mini/Super Mach A/C kit (Tucson)	26 lbs.
Deluxe Add-A-Room, 8' model	25 lbs.	Coleman® Mini/Super Mach A/C	110 lbs.
Deluxe Add-A-Room, 10' model	28 lbs.	Extra propane cylinder (empty)	18 lbs.
Deluxe Add-A-Room, 12' model	31 lbs.	Extra propane cylinder (full)	40 lbs.
Self-storing canopy, 8' model	16 lbs.		
Self-storing canopy, 10' model	21 lbs.		
Self-storing canopy, 12' model	27 lbs.		

For additional accessory weights, contact your authorized Fleetwood Folding Trailer Dealer.

Due to the overall length and lighter tongue weight on trailers equipped with the front storage box, undesirable towing characteristics may occur until additional weight can be placed inside the front storage box compartment.

**NOTE:** Cargo weights for front storage box model trailers must not exceed 150 pounds.

### **CAUTION**

With the added trailer weight of optional accessories, weight distribution of the trailer may become unbalanced. This could result in a trailer sway condition while in transit. Certain makes and models of tow vehicles may not be factory equipped to handle these situations. Therefore, a weight distribution hitch or anti-sway device is recommended dependant on your tow vehicle.

**NOTE:** For more information, see Towing Guidelines section of this manual or consult your local dealer.

## TIRE AND CARGO INFORMATION

### INTRODUCTION

Beginning with vehicles and trailers under 10,000 pounds produced in September 2005, the National Highway Traffic Safety Administration is requiring the phase in of improved tire sidewall identification markings, a new cargo/tire information placard and supplemental tire information to be included to manufacturers' owner's manuals.

The sections which follow consist of excerpts from the NHTSA publication "Tire Safety-Everything Rides on It," instructions on how to determine the amount of cargo permissible for your trailer, and a glossary of tire terminology.

The new trailer placard, which discloses the trailer capacity weight, can be found near the existing Federal Certification Label at the left front sidewall of your trailer.

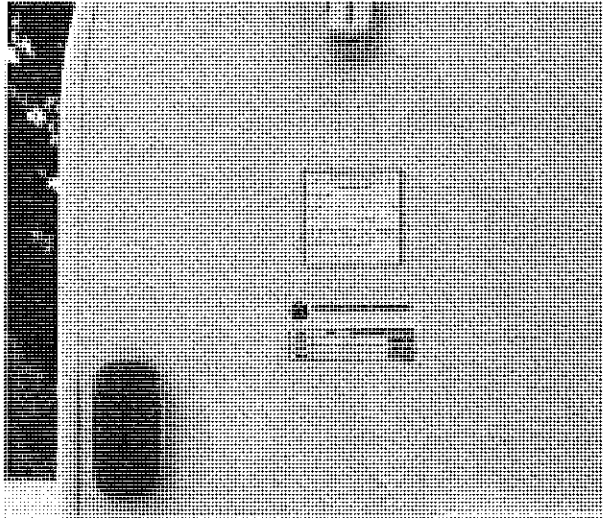



FIGURE 1

Photo of trailer with location and position of Certification label and placard shown

The placard will indicate the amount of cargo weight, which can be safely applied to your trailer. Even though this rating is not exceeded when you load your trailer, the loading and weighing instructions found in your owner's manual must be followed. Refer to the section on trailer loading in your owner's manual.

**TIRE AND LOADING INFORMATION**

TIRE	SIZE	COLD TIRE PRESSURE	SEE OWNER'S MANUAL FOR ADDITIONAL INFORMATION 15-129
FRONT			
REAR			
SPARE			

FIGURE 2

Photo/image of placard

Fleetwood physically weighs each individual trailer with equipped options produced at the factory using calibrated scales to determine the exact amount of cargo, which can be loaded. Some exceptions, which are calculated, should be noted as follows:

- Propane - The calculated weight of Propane, which feeds the various on board appliances, has been added to reduce the cargo rating (Propane cylinders equipped are assumed full).
- On-Board Batteries – The calculated weight for batteries has been added to reduce the cargo rating.

All other loose items added by the consumer, as well as fresh water, are considered to be cargo.

It should be noted that any other add-on items not supplied by Fleetwood nor installed by Fleetwood will reduce the amount of cargo which can be carried.

On trailers equipped with the trailer placard, selling dealers are required by law to apply a new placard with an adjusted cargo rating to account for the reduction of permissible cargo due to added items by the dealer or their equipment installer. If you are uncertain about the accuracy of the label, contact your dealer directly or contact Fleetwood for assistance.

It is ultimately the responsibility of the user to correctly load the trailer, distribute the weight appropriately and to not exceed the placard cargo rating disclosed. Instructions on how to properly accomplish this are disclosed in the owner's manual.

This portion of the Owner's Manual contains tire safety information as required by 49 CFR 575.6.

Section 1, based in part on the National Highway Traffic Safety Administration's Brochures entitled "Tire Safety- Everything Rides on It", contains the following items:

- Tire labeling, including a description and explanation of each marking on the tires, and information about the DOT Tire Identification Number (TIN).
- Recommended tire inflation pressure, including a description and explanation of:
  - A. Cold inflation pressure.
  - B. Vehicle Placard and location on the trailer.
  - C. Adverse safety consequences of under inflation (including tire failure).
  - D. Measuring and adjusting air pressure for proper inflation.
- Tire Care, including maintenance and safety practices.
- Trailer load limits, including a description and explanation of the following items:
  - A. Locating and understanding the load limit information, total load capacity, and cargo capacity.
  - B. Calculating total cargo capacities.
  - C. Determining compatibility of tire and trailer load capabilities.
  - D. Adverse safety consequences of overloading on handling and stopping on tires.

Section 2 contains "Steps for Determining Correct Load Limit"

Section 3 contains a Glossary of Tire Terminology, including "cold inflation pressure", "maximum inflation pressure", "recommended inflation pressure", and other non-technical terms.

## **SECTION 1**

The National Traffic Safety Administration (NHTSA) has published a brochure (DOT HS 809 361) that discusses all aspects of Tire Safety, as required by CFR 575.6. The brochure is reproduced in part below. It can be obtained and downloaded from NHTSA, free of charge, from the following web site:

[http://www.nhtsa.dot.gov/cars/rules/TireSafety/rideonit/tires\\_index.html](http://www.nhtsa.dot.gov/cars/rules/TireSafety/rideonit/tires_index.html)

Studies of tire safety show that maintaining proper tire pressure, observing tire and trailer load limits (not carrying more weight in your trailer than your tires or trailer can safely handle), avoiding road hazards, and inspecting tires for cuts, slashes, and other irregularities are the most important things you can do to avoid tire failure, such as tread separation or blowout and flat tires. These actions, along with other care and maintenance activities, can also:

- Improve trailer handling.
- Help protect you and others from avoidable breakdowns and accidents.
- Improve fuel economy.
- Increase the life of your tires

This booklet presents a comprehensive overview of tire safety, including information on the following topics:

- Basic tire maintenance.
- Uniform Tire quality Grading System.
- Fundamental characteristics of tires.
- Tire safety tips.

Use this information to make tire safety a regular part of your trailer maintenance routine. Recognize that the time you spend is minimal compared with the inconvenience and safety consequences of a flat tire or other tire failure.

## **SAFETY FIRST-BASIC TIRE MAINTENANCE**

Properly maintained tires improve the steering, stopping, traction, and load-carrying capability of your trailer. Underinflated tires and overloaded vehicles are a major cause of tire failure. Therefore, as mentioned above, to avoid flat tires and other types of tire failure, you should maintain proper tire pressure, observe tire and vehicle load limits, avoid road hazards, and regularly inspect your tires.

## **FINDING YOUR TRAILER'S RECOMMENDED TIRE PRESSURE AND LOAD LIMITS**

Tire information placards and trailer certification labels contain information on tires and load limits. These labels indicate the trailer manufacturer's information including:

- Recommended tire size.
- Recommended tire inflation pressure.
- Trailer capacity weight (TCW – the maximum cargo weight a trailer is designed to carry).
- Front and rear gross axle weight ratings (GAWR – the maximum weight the axle systems are designed to carry).

Both placards and certification labels are permanently attached to the trailer on the forward half of the left side, and are easily readable from outside the vehicle without moving any part of the vehicle.

## **UNDERSTANDING TIRE PRESSURE AND LOAD LIMITS**

Tire inflation pressure is the level of air in the tire that provides it with load-carrying capacity and affects the overall performance of the trailer. The tire inflation pressure is a number that indicates the amount of air pressure – measured in pounds per square inch (psi) – a tire requires to be properly inflated. (You will also find this number on the trailer information placard expressed in kilopascals (kPa), which is the metric measure used internationally.)

Trailer manufacturers determine this number based on the trailer's design load limit, that is, the greatest amount of weight a trailer can safely carry and the trailer's tire size. The proper tire pressure for your trailer is referred to as the "recommended cold inflation pressure." (As you will read below, it is difficult to obtain the recommended tire pressure if your tires are not cold.)

Because tires are designed to be used on more than one type of trailer, tire manufacturers list the "maximum permissible inflation pressure" on the tire sidewall. This number is the greatest amount of air pressure that should ever be put in the tire under normal driving conditions.

## **CHECKING TIRE PRESSURE**

It is important to check your trailer's tire pressure (including the spare) at least once a month for the following reasons:

- Most tires may naturally lose air over time.
- Tires can lose air suddenly if you drive over a pothole or other object or if you strike the curb when parking.
- With radial tires, it is usually not possible to determine underinflation by visual inspection.

For convenience, purchase a tire pressure gauge to keep in your tow vehicle or trailer. Gauges can be purchased at tire dealerships, auto supply stores, and other retail outlets.

The recommended tire inflation pressure that trailer manufacturers provide reflects the proper psi when a tire is cold. The term cold does not relate to the outside temperature. Rather, a cold tire is one that has not been driven on for at least three hours. When you drive, your tires get warmer, causing the air pressure within them to increase.



Therefore, to get an accurate tire pressure reading, you must measure tire pressure when the tires are cold or compensate for the extra pressure in warm tires.

## **STEPS FOR MAINTAINING PROPER TIRE PRESSURE**

- Step 1: Locate the recommended tire pressure on the vehicle's tire information placard, or certification label.
- Step 2: Record the tire pressure of all tires.
- Step 3: If the tire pressure is too high in any of the tires, slowly release air by gently pressing on the tire valve stem with the edge of your tire gauge until you get to the correct pressure.
- Step 4: If the tire pressure is too low, note the difference between the measured tire pressure and the correct tire pressure. These "missing" pounds of pressure are what you will need to add.
- Step 5: At a service station, add the missing pounds of air pressure to each tire that is underinflated.
- Step 6: Check all the tires to make sure they have the same air pressure.

If you have been towing your trailer and think that a tire is underinflated, fill it to the recommended cold inflation pressure indicated on your vehicle's tire information placard or certification label. While your tire may still be slightly underinflated due to the extra pounds of pressure in the warm tire, it is safer to drive with air pressure that is slightly lower than the trailer manufacturer's recommended cold inflation pressure than to drive with a significantly underinflated tire. Since this is a temporary fix, don't forget to recheck and adjust the tire's pressure when you can obtain a cold reading. Make sure any leaks are repaired promptly by a qualified shop.

## **TIRE SIZE**

To maintain tire safety, purchase new tires that are the same size as the trailer's original tires or another size recommended by the manufacturer. Look at the tire information placard or the sidewall of the tire you are replacing to find this information. If you have any doubt about the correct size to choose, consult with the tire dealer.

## **TIRE TREAD**

The tire tread provides the gripping action and traction that prevent your vehicle from slipping or sliding, especially when the road is wet or icy. In general, tires are not safe and should be replaced when the tread is worn down to 1/16 of an inch. Tires have built-in treadwear indicators that let you know when it is time to replace your tires. These indicators are raised sections spaced intermittently in the bottom of the tread grooves. When they appear "even" with the outside of the tread, it is time to replace your tires. Another method for checking tread depth is to place a penny in the tread with Lincoln's head upside down and facing you. If you can see the top of Lincoln's head, you are ready for new tires.

## **TIRE BALANCE**

To avoid vibration or shaking of the vehicle when a tire rotates, the tire must be properly balanced. This balance is achieved by positioning weights on the wheel to counterbalance heavy spots on the wheel-and-tire assembly. Special equipment is used and performed by a qualified technician.

## **TIRE REPAIR**

The proper repair of a punctured tire requires a plug for the hole and a patch for the area inside the tire that surrounds the puncture hole. Punctures through the tread can be repaired if they are not too large, but punctures to the sidewall should not be repaired. Tires must be removed from the rim to be properly inspected before being plugged and patched.

## **TIRE FUNDAMENTALS**

Federal law requires tire manufacturers to place standardized information on the sidewall of all tires. This information identifies and describes the fundamental characteristics of the tire and also provides a tire identification number for safety standard certification and in case of a recall.

## INFORMATION ON PASSENGER VEHICLE TIRES

Please refer to the diagram below.

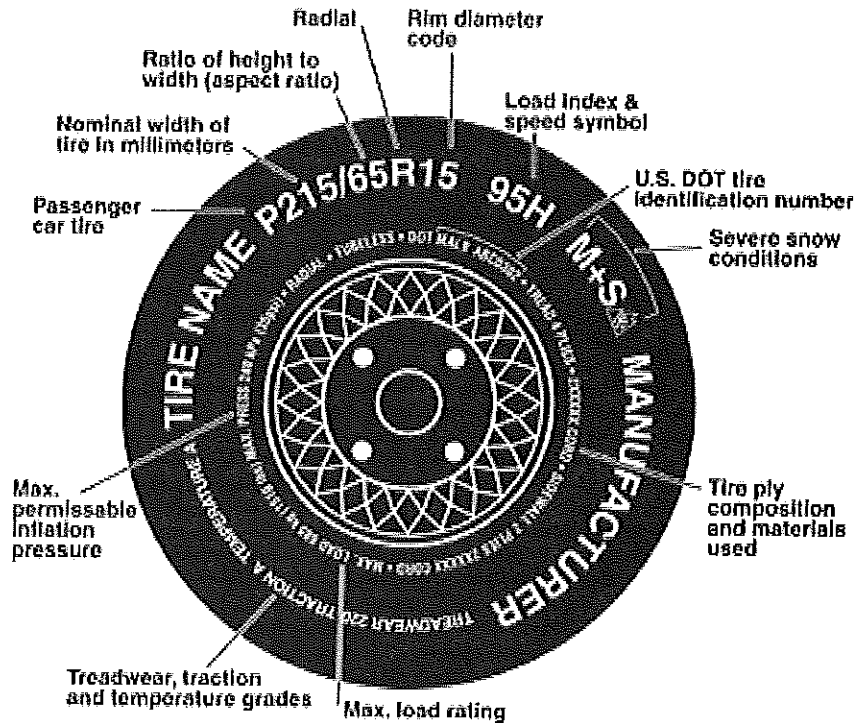

P – The “P” indicates the tire is for passenger vehicles.

NOTE: Passenger car tires are not recommended for use on trailers, because the capacity ratings are not marked on the sidewalls of these tires. In the event a passenger car tire is used, the capacity must be derated by 10%. Contact your local tire dealer.

Next number – This three-digit number gives the width in millimeters of the tire from sidewall edge to sidewall edge. In general, the larger the number, the wider the tire.

Next number – This two-digit number, known as the aspect ratio, gives the tire’s ratio of height to width. Numbers of 70 or lower indicate a short sidewall for improved steering response and better overall handling on dry pavement.

R – The “R” stands for radial. Radial ply construction of tires has been the industry standard for the past 20 years.

Next number – This two-digit number is the wheel or rim diameter in inches. If you change your wheel size, you will have to purchase new tires to match the new wheel diameter.

Next number – This two- or three-digit number is the tire’s load index. It is a measurement of how much weight each tire can support. Note: You may not find this information on all tires because it is not required by law. Contact you local tire dealer.

M+S – The “M+S” or “M/S” indicates that the tire has some mud and snow capability. Most radial tires have these markings.

Speed Rating – The speed rating denotes the speed at which a tire is designed to be driven for extended periods of time. The ratings range from 99 miles per hour (mph) to 186 mph. These ratings are listed below. Note: You may not find this information on all tires because it is not required by law.

<b>Letter Rating</b>	<b>Speed Rating</b>
<b>Q</b>	<b>99 mph</b>
<b>R</b>	<b>106 mph</b>
<b>S</b>	<b>112 mph</b>
<b>T</b>	<b>118 mph</b>
<b>U</b>	<b>124 mph</b>
<b>H</b>	<b>130 mph</b>
<b>V</b>	<b>149 mph</b>
<b>W</b>	<b>168* mph</b>
<b>Y</b>	<b>186* mph</b>

\*For tires with a maximum speed capability over 149 mph, tire manufacturers sometimes use the letters ZR. For those with a maximum speed capability over 186 mph, tire manufacturers always use the letters ZR.

**U.S. DOT Tire Identification Number** – This begins with the letters “DOT” and indicates that the tire meets all federal standards. The next two numbers or letters are the plant code where it was manufactured, and the last four numbers represent the week and year the tire was built. For example, the numbers 3197 means the 31<sup>st</sup> week of 1997. The other numbers are marketing codes used at the manufacturer’s discretion. This information is used to contact consumers if a tire defect requires a recall.

**Tire Ply Composition and Materials Used** – The number of plies indicates the number of layers of rubber-coated fabric in the tire. In general, the greater number of plies, the more weight a tire can support. Tire manufacturers also must indicate the materials in the tire, which include steel, nylon, polyester, and others.

**Maximum Load Rating** – This number indicates the maximum load in kilograms and pounds that can be carried by the tire.

**Maximum Permissible Inflation Pressure** – This number is the greatest amount of air pressure that should ever be put in the tire under normal driving conditions.

## ADDITIONAL INFORMATION ON LIGHT TRUCK TIRES

Please refer to the following diagram.

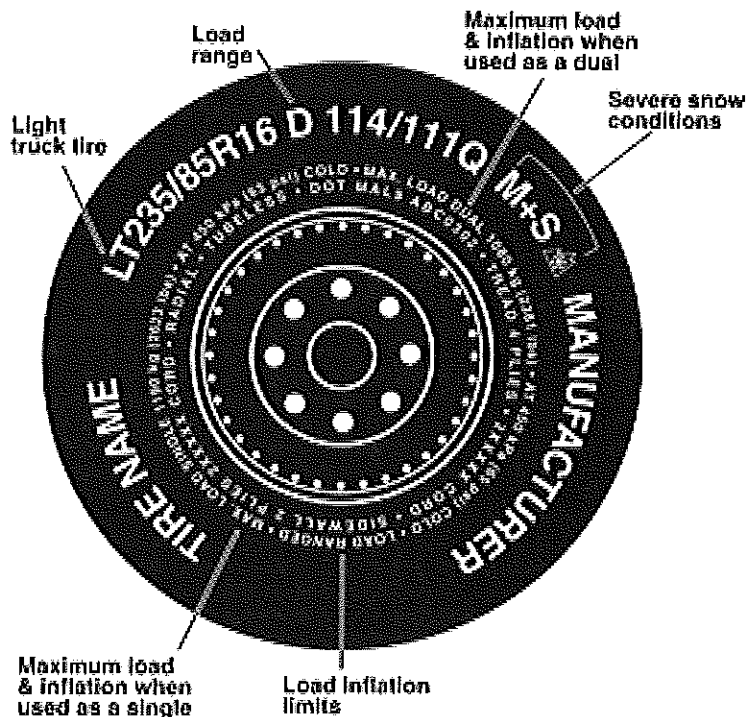

Tire for light trucks have other markings besides those found on the sidewalls of passenger tires.

LT – The “LT” indicates the tire is for light trucks or trailers.

ST – An “ST” is an indication the tire is for trailer use only.

Max. Load Dual kg (lbs) at kPa (psi) Cold – This information indicates the maximum load and tire pressure when the tire is used as a dual; that is, when four tires are put on each rear axle (a total of six or more tires on the vehicle). Note: Not applicable to RV trailers.

Max. Load Single kg (lbs) at kPa (psi) Cold – This information indicates the maximum load and tire pressure when the tire is used as a single. Note: Applicable to RV trailers.

Load Range – This information identifies the tire’s load-carrying capabilities and its inflation limits.

### TRAILER LOAD LIMITS

Determining the load limits of a trailer includes more than understanding the load limits of the tires alone.

On a trailer, there is a Federal certification label that is located on the forward half of the left (road) side of the unit.

The certification label will indicate the trailer’s gross vehicle weight rating (GVWR). This is the most weight the fully loaded trailer can weigh. It will also provide the gross axle weight rating (GAWR). This is the most weight a particular axle can weigh. If there are multiple axles, the GAWR of each axle will be provided.

In the same location as the certification label described above, there is a trailer placard. This placard provides tire and loading information. In addition, this placard will show a statement regarding maximum cargo capacity.

## **CARGO CAPACITIES**

Cargo can be added to the vehicle, up to the maximum weight specified on the placard. The combined weight of the cargo is provided as a single number. In any case, remember: the total weight of a fully loaded trailer can not exceed the stated GVWR.

Water and propane also need to be considered. The weight of fully filled propane containers is considered part of the weight of the RV before it is loaded with cargo and is not considered part of the disposable cargo load. Water however, is a cargo weight and is treated as such. If there is a fresh water storage tank of 100 gallons, this tank when filled would weigh about 800 pounds. If more cargo is being transported, water can be off-loaded to keep the total amount of cargo added to the vehicle within the limits of the GVWR so as not to overload the vehicle. Understanding this flexibility will allow you, the owner, to make choices that fit your travel and camping needs.

When loading your cargo, be sure it is distributed evenly to prevent overloading front to back and side to side. Heavy items should be placed low and as close to the axle positions as reasonable. Too many items on one side may overload a tire. The best way to know the actual weight of the trailer is to weigh it at a public scale. Talk to your RV dealer to discuss the weighing methods needed to capture the various weights related to the RV. This would include weights for the following: axles, wheels, hitch or pin (in the case of a trailer) and total weight.

## **HOW OVERLOADING AFFECTS YOUR RV AND TIRES**

The results of overloading can have serious consequences for passenger safety. Too much weight on your trailer's suspension system can cause spring, shock absorber, or brake failure, handling or steering problems, irregular tire wear, tire failure or other damage.

An overloaded trailer is hard to tow and hard to stop. In cases of serious overloading, brakes can fail completely, particularly on steep hills. The load a tire will carry safely is a combination of the size of tire, its load range, and corresponding inflation pressure.

Excessive loads and/or underinflation cause tire overloading and, as a result, abnormal tire flexing occurs. This situation can generate an excessive amount of heat within the tire. Excessive heat may lead to tire failure.

It is the air pressure that enables a tire to support the load, so proper inflation is critical. Since RVs can be configured and loaded in many ways, air pressures must be determined from actual loads (determined by weighing) and taken from the load and inflation tables provided by the tire manufacturer. These air pressures may differ from those found on the certification label. However, they should never exceed the tire limitation for load or air pressure. If you discover that your tires cannot support the actual weights, the load will need to be lightened.

## **TIRE SAFETY TIPS**

### **PREVENTING TIRE DAMAGE**

- Slow down if you have to go over a pothole or other object in the road.
- Do not run over curbs or other foreign objects in the roadway, and try not to strike the curb when parking.

### **TIRE SAFETY CHECKLIST**

- Check tire pressure regularly (at least once a month), including the spare.
- Inspect tires for uneven wear patterns on the tread, cracks, foreign objects, or other sign of wear or trauma.
- Remove bits of glass and foreign objects wedged in the tread.
- Make sure your tire valve stems have valve caps.
- Check tire pressure before going on a long trip.
- Do not overload your trailer. Check the Tire Information and Loading Placard or User's Manual for the maximum recommended load for the trailer.

## **SECTION 2**

### **STEPS FOR DETERMINING CORRECT LOAD LIMIT**

1. Locate the statement: The weight of cargo should never exceed XXX kg or XXX lbs on your trailer's placard.
2. This figure equals the available amount of cargo and luggage load capacity.
3. Determine the combined weight of luggage and cargo being loaded on the trailer. That weight may not safely exceed the available cargo and luggage load capacity.

## **SECTION 3**

### **GLOSSARY OF TIRE TERMINOLOGY**

**Bead** – The part of the tire that is made of steel wires, wrapped or reinforced by ply cords and that is shaped to fit the rim.

**Bead separation** – This is the breakdown of the bond between components in the bead.

**Bias ply tire** – A pneumatic tire in which the ply cords that extend to the beads are laid at alternate angles substantially less than 90 degrees to the centerline of the tread.

**Carcass** – The tire structure, except tread and sidewall rubber which, when inflated, bears the load.

**Chunking** – The breaking away of pieces of the tread or sidewall.

**Cold inflation pressure** – The pressure in the tire before you drive.

**Cord** – The strands forming the plies in the tire.

**Cord separation** – The parting of cords from adjacent rubber compounds.

**Cracking** – Any parting within the tread, sidewall, or inner liner of the tire extending to cord material.

**Groove** – The space between two adjacent tread ribs.

**GVWR (Gross Vehicle Weight Rating)** – Is the maximum permissible weight of this trailer when fully loaded. It includes all weight at the trailer axle(s) and tongue or pin.

**Gross Axle Weight Rating (GAWR)** – The value specified as the load carrying capacity of a single axle system, as measured at the tire-ground interfaces.

**Hitch Weight** – The vertical trailer load supported by the hitch ball.

**Innerliner** – The layer(s) forming the inside surface of a tubeless tire that contains the inflating medium within the tire.

**Innerliner separation** – The parting of the innerliner from cord material in the carcass.

**Intended outboard sidewall** – The sidewall that contains a white-wall, bears white lettering or bears manufacturer, brand, and/or model name molding that is higher or deeper than the same molding on the other sidewall of the tire or the outward facing sidewall of an asymmetrical tire that has a particular side that must always face outward when mounted on a vehicle.

Light truck (LT) tire – A tire designated by its manufacturer as primarily intended for use on lightweight trucks, multipurpose passenger vehicles, or trailers.

Load rating – The maximum load that a tire is rate to carry for a given inflation pressure.

Maximum load rating – The load rating for a tire at the maximum permissible inflation pressure for that tire.

Maximum permissible inflation pressure – The maximum cold inflation pressure to which a tire may be inflated.

Maximum loaded trailer weight – The sum of the unloaded vehicle weight (UVW), propane weight and trailer capacity weight.

Open splice – Any parting at any junction of tread, sidewall, or innerliner that extends to cord material.

Outer diameter – The overall diameter of an inflated new tire.

Overall width – The linear distance between the exteriors of the sidewalls of an inflated tire, including elevations due to labeling, decorations, or protective bands or ribs.

Pin weight – The vertical trailer load supported by the king pin of a fifth wheel hitch.

Ply – A layer of rubber-coated parallel cords.

Ply separation – A paring of rubber compound between adjacent plies.

Pneumatic tire – A mechanical device made of rubber, chemicals, fabric and steel or other materials, that, when mounted on an automotive wheel, provides the traction and contains the gas or fluid that sustains the load.

Radial ply tire – A pneumatic tire in which the ply cords that extend to the beads are laid at substantially 90 degrees to the centerline of the tread.

Recommended inflation pressure – This is the inflation pressure provided by the trailer manufacturer on the Tire Information label and on the Certification/VIN tag.

Reinforced tire – A tire designed to operate at higher loads and at higher inflation pressures than the corresponding standard tire.

Rim – A metal support for a tire or a tire and tube assembly upon which the tire beads are seated.

Rim diameter – This means the nominal diameter of the bead seat.

Rim size designation – This means the rim diameter and width.

Rim type designation – This means the industry of manufacturer's designation for a rim by style or code.

Rim width – This means the nominal distance between rim flanges.

Section width – The linear distance between the exteriors of the sidewalls of an inflated tire, excluding elevations due to labeling, decorations, or protective bands.

Sidewall – That portion of a tire between the tread and bead.

Sidewall separation – The parting of rubber compound from the cord material in the sidewall.

TCW – Trailer capacity weight, the maximum cargo weight a trailer is designed to carry. Note: includes fresh water as cargo weight.

Tread – That portion of a tire that comes into contact with the road.

Tread rib – A tread section running circumferentially around a tire.

Tread separation – Pulling away of the tread from the tire carcass.

Treadwear indicators (TWI) – The projections within the principal grooves designed to give a visual indication of the degrees of wear of the tread.

UVW (Unloaded Vehicle Weight) – Is the weight of this trailer as manufactured at the factory. It includes all weight at the trailer axle(s) and tongue.

## SET-UP INSTRUCTIONS

**IMPORTANT:** Operations for items such as the lifting system, stabilizers and galley may vary between the different series of trailers. The operating instructions for all series of trailers are outlined in this manual. When reading this manual, follow the operating instructions that pertain to the specific equipment on your particular model trailer.

Select a level campsite, preferably not on soft or sandy terrain. Pull or back the folding trailer to desired position for campsite. Place wheel chocks in front and in back of both wheels. Disconnect electrical pigtail and safety chains, and release the coupler release handle. Pull the lock pin (located on the tongue jack) and let the tongue jack swing down into position. Ensure the lock pin has locked the tongue jack in place in the top right hole of the bracket.

**NOTE:** If a level campsite cannot be obtained, use of leveling blocks under the tires is recommended to level the trailer from side to side prior to lowering the stabilizers.

### WARNING

Failure to properly engage the lock pin on the tongue jack could result in the trailer tongue suddenly dropping and causing personal injury. **DO NOT** move the trailer over loose and/or uneven ground such as shale, gravel, sand, etc., with the tongue jack fully extended. Such movement could result in severe stress to the tongue jack mounting bracket and retention ring possibly causing failure and personal injury.

Pull the handle of the tongue jack up and rotate the handle in a clockwise motion to lift the trailer tongue up and off the ball hitch. Never attempt to physically lift the trailer tongue up and off of the ball hitch. To prevent interference during the set up of the trailer, drive the vehicle away from the trailer. Adjust the tongue jack height so that the trailer is level horizontally. **Do not use the stabilizers to adjust the level of the trailer. Damage to the stabilizers could occur.**

Unlatch the four "top" latches. Insert the key into the access door lock and turn clockwise. The push-button and handle will pop out. Rotate the handle clockwise to open the access door. Pull

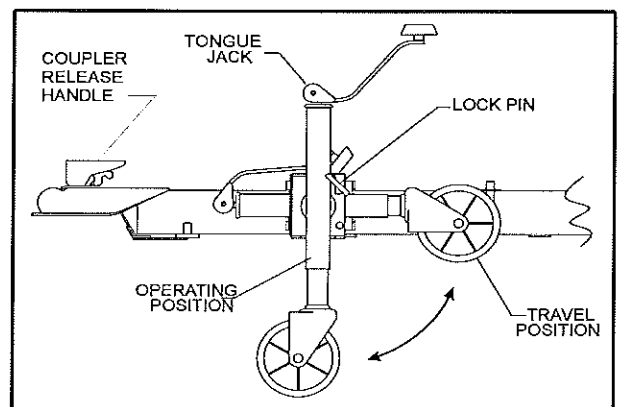

**Tongue Jack**



outward on the access door to provide an entrance. (Some models may require the top assembly to be slightly raised before the access door can be lowered.)

**IMPORTANT:** Know where your fire extinguisher is located and how to use it. Portable fire extinguishers are most valuable when used immediately on small fires. They have a limited amount of fire extinguishing material, and therefore, must be used properly so this material is not wasted.

**IMPORTANT:** Before lowering the stepper access door, ensure that the area directly beneath the access door is free from obstacles to prevent damage to the exterior finish of the access door. Do not store any perishable items inside the stepper access door with the storage compartment feature, located at the bottom of the door. This is not a water tight compartment.

The hinged access door can be opened and latched into the open position utilizing the retaining latch on the body panel.

**NOTE:** Either style of access door can be closed and locked with the screen door assembly installed.

## LIFT SYSTEM OPERATION

### **CAUTION**

Ensure all top latches are unhooked prior to raising the top assembly. Bicycles, canoes, and large items should be removed from the top assembly before raising the top.

Locate the crank and stabilizer handles stored inside the step door, cabinet, or front storage box on most models.

**HINT:** If the trailer is equipped with an optional canopy, unzip the canopy and extend before raising the top. Ensure no sharp objects are in contact with the canopy.

## CRANK-UP/CRANK-DOWN LIFT SYSTEM

Attach crank handle onto the crank shaft. Rotate the crank handle in a clockwise motion to raise the top until it is fully extended or the tent fabric becomes reasonably taut, whichever comes first. A clicking sound should always be audible while cranking the top up. If not, when the top is fully raised, lightly over-crank the handle to engage the clutch mechanism.

### **WARNING**

Failure to ensure the crank-up/crank-down lift system is properly operating could result in an unexpected descent of the top assembly or rapid counter-clockwise rotation of the crank handle. Do not release the crank handle if the audible clicking sound is not heard. Lower top assembly completely and repeat set-up.

### **CAUTION**

Do not attempt to operate the beds in or out prior to fully raising the top assembly.

## POWER LIFT SYSTEM (where applicable)

Refer to the operating instructions furnished in your Owner's Information Package for detailed instructions.

## STABILIZER JACKS

### CRANK-DOWN STABILIZERS

From underneath the corner of the trailer, insert crank handle onto stabilizer shaft and rotate crank handle clockwise to extend jack to downward position. Repeat for remaining stabilizers and return crank handle to storage location.

**IMPORTANT:** The threaded shaft of the crank-down stabilizer jacks should be lubricated with usage, or as environmental conditions change, to deter corrosion (with white lithium grease or equivalent).

### SWING-DOWN STABILIZERS

To release the stabilizer jacks from the locked travel position, reach under the corner of the trailer, firmly grasp the jack and push it toward the center of the trailer (approximately ½") and swing down to lock the jack in the lowered position. By pushing down on the quick release lever, the inner leg can be extended to the ground. Insert the stabilizer handle through the front hole and allow handle to pass completely through the rear hole of the stabilizer. Apply downward pressure to extend the inner legs of the stabilizer jacks to stabilize the trailer.

**IMPORTANT:** Ensure stabilizer handle is extended through the rear hole of the stabilizer or inadvertent damage can occur to the inner stabilizer leg (holes). Lubrication of the swing-down stabilizer jacks is not recommended, due to the metal surface contact needed for proper operation of the inner stabilizer leg.

Repeat procedure for remaining stabilizers. Over-stabilizing the trailer can result in difficult operation of the access door or screen door when completely set-up.

**NOTE:** Not all model trailers are equipped with four stabilizers. Certain models utilize the trailer tongue jack as a stabilizing support. The tongue jack should always remain down and locked into position.

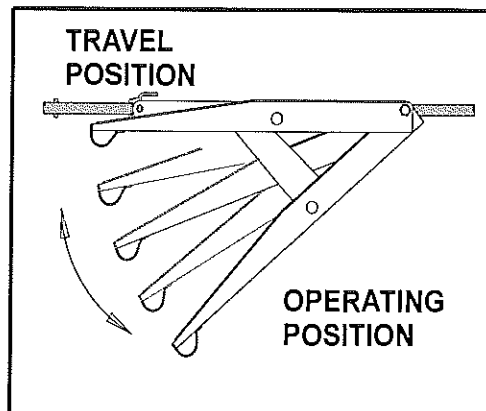

**Crank-Down Stabilizer**

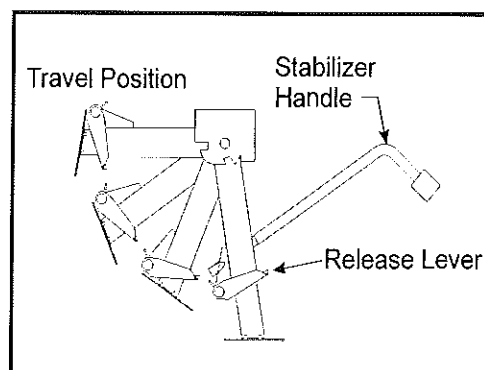

**Swing-Down Stabilizer**

### CAUTION

Do not lower the stabilizer jacks prior to raising the trailer top as this can place an undue stress on the trailer frame and lift system resulting in premature wear. Do not use the stabilizer jacks to take the weight of the trailer off of the tires. The jacks are intended ONLY TO "STABILIZE."

Because of certain terrain conditions, it may be advisable to locate flat blocks of wood or flat rocks under the base plates of the stabilizer jacks.

## BEDS

### WARNING

Some materials may contain a urea-formaldehyde resin and will release very small quantities of formaldehyde. Formaldehyde levels in the indoor air can cause temporary eye and respiratory irritation, and may aggravate respiratory conditions or allergies for some individuals. Ventilation will reduce indoor formaldehyde levels.

**HINT:** Prior to extending the beds on storage box models, remove any needed items from the storage compartment. Also, at this time finish set-up of the canopy ensuring that one corner is sloped to allow for condensation and rain to drain and that all ground stakes, ropes, etc., are attached and secured.

**NOTE:** Every three months or as use and performance requires, place one drop of lubricant (example: 3 in 1 oil) between the plastic bed roller and mounting bolt. This will ensure smooth operation of the beds.

Locate straps on the bed frame and pull outward until the bed stops.

**IMPORTANT:** This movement must be done slowly and evenly to prevent inadvertent jamming or wedging of the bed on the sliding tracks. **DO NOT** place any weight on the beds while they are extended without first attaching the lower bed supports to the frame. Damage to the bed rails or bed frames may result. Any damage to the bed rails or bed frames, resulting from weight being applied to the bed area without the lower bed supports in position, will not be considered a warranty item. Be aware of any tent material that may become entangled. Remove any entangled tenting before continuing to pull the bed out.

Kneel down beneath the side of the fully extended bed. Pull down and swivel the lower bed support legs from their travel positions. Lift the bed slightly while placing the free end of the bed supports over the support pegs located on the trailer frame or rear bumper.

For models equipped with back saver bed legs: Lightly lift up on the bed while simultaneously pushing forward on the top of the bed support leg. Push the bed support leg until the catch mechanism locks the leg into position. Try pushing rearward on the bed support leg to ensure it is locked into the set-up position. If not, repeat operation. Perform the same procedure for the opposite bed.

**IMPORTANT:** Ensure lower bed support is fully engaged on the peg, otherwise any weight placed on the bed will cause damage to the bed rail or bed frame. Lower bed supports are designed to swivel into travel or setup position; do not force the bed supports when setting up or taking down.

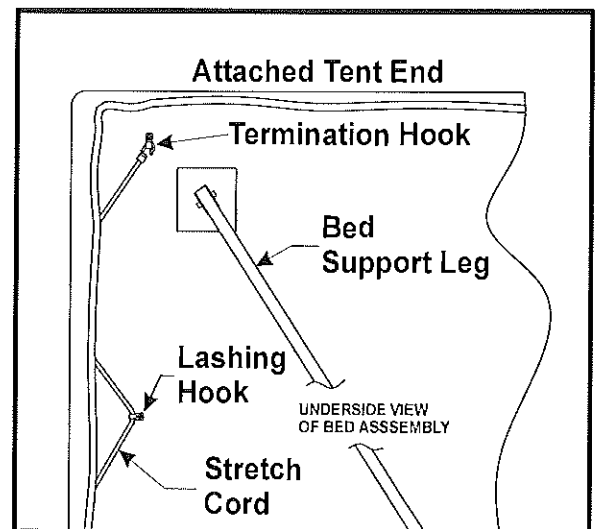

## GLIDE-OUT COMPARTMENT (where applicable)

Locate the two locking handles on the outside edge of the glide-out compartment. Pull the handle straight out and rotate 90° to disengage the lock arms from the main body of the trailer. With the lock arms disengaged, place your hands inside the two inner "grab" handles. Firmly and evenly extend the glide-out compartment from the trailer. Pull outward until the glide-out engages the detent or lock position. Slightly lift upward while pulling out. A gentle rolling motion can be felt as the rollers lock into the track. To ensure the glide-out is "locked-in", gently try to push the glide-out compartment inward. If moderate resistance is felt, the glide-out is correctly extended.

**IMPORTANT:** Ensure the tent enclosure (bay window) does not catch against the body rails while extending the glide-out. Failure to do so will cause the tent enclosure to tear or snag. Maximum weight rating of glide-out compartment is 1000 pounds.

### **WARNING**

Failure to ensure the glide-out compartment is "locked-in" could result in an unexpected closing of the glide-out. Personal injury or damage to the trailer could occur. Ensure the surrounding area is clear of all obstacles prior to opening the glide-out.

## TENT ENCLOSURE

**From outside the trailer:** With both beds fully extended and supported, reach underneath the tent fabric and grasp the side of the canvas bow and rotate toward the end of the bed.

**From inside the trailer:** Attach the removable bed bow supports by snapping the pole tip onto the upper U-shaped bed bow. Use the bed bow support to gently push the outer bow the remaining way into position. Insert the opposite end of the bed bow support into the retainer bracket located on the top assembly. These supports can be adjusted by pressing the spring clip on the pole and extending the rod to the next adjustment hole.

**From outside the trailer:** Pull the tent side flaps at the bottom over the edge of the bed frame and attach the exposed stretch cords to the nearest hooks on the underside of the bed.

Repeat for opposite bed end. (Refer to diagram on tent bed hooks.)

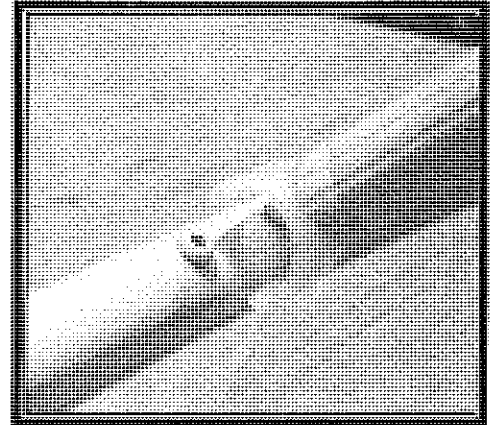

*Bed Bow Support*

### **⚠ WARNING**

Ensure the stretch cord is attached to the lashing hooks on the underside of each bed before using the bed. Failure to attach the stretch cord can allow small objects or children to slip between the tent enclosure and the bed frame.

## GLIDE-OUT MODELS (where applicable)

Attach Velcro around perimeter of bay window to glide-out compartment and side body rails.

## SWING-LEVEL GALLEY

**From inside the trailer:** Grasp the tubular bar of the swing-level galley (at the decal) and raise until the bottom of the upper galley rests securely on the top of the lower galley. Do not accidentally drop the swing-level galley when lowering. Damage to the lower cabinet top or +12 volt electrical "kill" switch could occur.

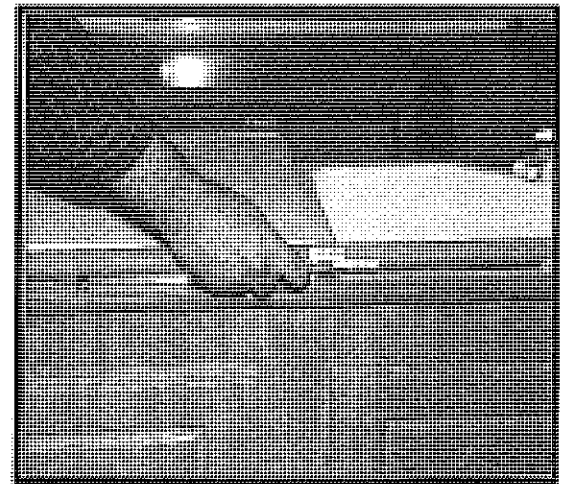

*Swing-Level Galley*

## HINGED GALLEY/STOVE CABINET

### HINGED UPPER GALLEY

Grasp the towel rack (metal bar at rear or side of galley) of the hinged upper galley assembly. Lift up and rotate toward the outside of the trailer.

**NOTE:** Both the swing level and hinged galleys must engage the electric "kill switch" atop the lower cabinet top to activate the +12 volt circuit for the top lights and internal appliances.

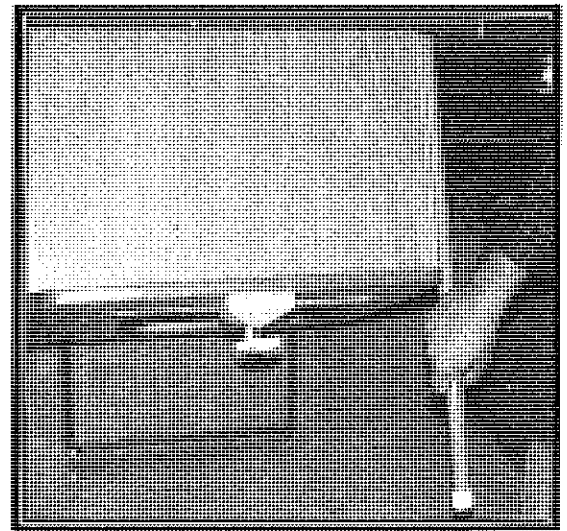

*Hinged Upper Galley*

## CAUTION

Ensure that the drapery panel behind the galley is secured with a safety tie or Velcro tab to eliminate the possibility of the drapes coming in contact with the stove.

## **BAY WINDOW (where applicable)**

### **TIP-OUT MODELS**

Push tenting and window cover outward away from galley cabinet. Lift swing-level galley into position. Locate the bay window adjustable U-shaped support bow assembly. Place U-shaped support bow into bay window and insert each leg tip into the recessed cups at each end of the lower galley. Adjust bow spring clips as necessary for tautness. Locate the upper removable bay window support rod. Insert the pointed tip of the support rod into the round grommet in the valance and into the top hole in metal U-shaped support bow. Attach opposite end of support rod to metal retainer bracket located on the top assembly and adjust the spring clip for proper tension.

To open the solid window flaps, pull the tent fabric away from the Velcro strips sewn onto the tent section. To open the clear vinyl windows, grasp the zipper tab and slide the zipper open. Both flaps can be rolled-up and stored at the bottom of the tent section.

### **GLIDE-OUT MODELS (where applicable)**

Ensure the glide-out compartment is fully extended and "locked-in". Rotate the attached bed bow support upward to the vertical position. Insert the pointed tip of the removable tent support rod into the round grommet on the valance and into the top hole in the metal bed bow. Attach the opposite end of the tent support rod to the metal retainer bracket located on the top assembly directly above the glide-out compartment. Adjust the support rod spring clip as needed for proper tension.

To open the solid window flaps, pull the tent fabric away from the Velcro strips sewn onto the tent section. To open the clear vinyl windows, grasp the zipper tab and slide the zipper open. Both flaps can be rolled-up and stored at the bottom of the tent section.

## **DINETTE**

Where applicable: Lift the backrest cushion off the dinette table. Lift the table and place face-down on bed mattress for later set-up. Slide the seat cushion inward. Set the backrest in place.

**NOTE:** Glide-out compartment seat benches will have hinged metal backrest supports which must be raised prior to setting the backrests in place.

Slide the seat cushion in place against the backrest, making sure that the plastic stops on the bottom of the cushion are wedged firmly against the interior frame of the seat bench. Arm rest and throw pillows are to be installed in the corner of the wrap-around sofa dinette.

**NOTE:** To lift dinette seat cushion, be certain to push the seat cushion firmly toward the backrest before lifting in order to prevent inadvertent damage to the plastic stops.

Extend the table legs completely so that both leg supports lock into position. Set table upright and check to ensure it is stable.

**For Bed Application:** Collapse the table legs and secure with the Velcro strap provided. Lower the table to the storage or travel position (ensure table is oriented correctly onto the bench). Place backrest cushions atop table and seat cushions (with plastic stop buttons) over benches.

**IMPORTANT:** The table top could be damaged by exposure to rain, excessive moisture or extended periods of sunlight.

## SCREEN DOOR

Unfasten the two screen door nylon web retaining straps. This will allow the screen door to hang by its glide cables. Standing at the door opening, pull down on the spring pin clip retaining the door frame and swivel clear of the engagement hole. Standing at the door threshold, reach up and grasp the bottom of the screen door with both hands. Raise and push the door toward the far side of the trailer to release it from its retaining bracket. Hold screen door up from the floor and move it toward the door opening.

From outside the trailer, grasp the door frame with both hands, one on either side, lower screen door into door threshold at base of doorway. Unlock screen door latch (handle) and step inside. Holding the door against the top assembly, lock into place with the two screen door sash locks or lock tabs. Fasten the tent material on either side of the door onto the mating Velcro on the door frame. Attach all tent material patches to mating Velcro on outside of door frame and body rails.

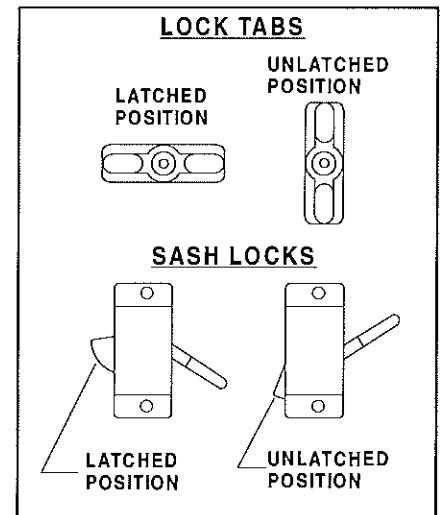

The top window pane of the screen door can be adjusted to various heights for ventilation.

## PULL-OUT SOFA BED (where applicable)

**For bed application:** Remove the backrest cushions from sofa and set aside. Standing at the center of the sofa, grasp the seat frame and gently pull outward toward the center of the trailer until the sofa is fully extended. Lay the backrest cushions on top of the exposed sofa frame. Always ensure that the plastic sofa guides (on underside of seat cushion) are securely positioned within the routed bench slots. Failure to do so could cause the sofa bed to unexpectedly disengage.

**NOTE:** To remove the large slide-out drawer, pull the drawer out approximately five inches and push up on the swivel thumb retaining latch (behind the cabinet front) to allow the plastic stop button on the side of the drawer to slide past.

**For seat application:** Slide sofa bed inward and install backrest cushion above seat cushion against wall.

## FRONT TRUNK STORAGE AREA

To access the trunk area, in trailers so equipped, with the trailer in the **closed position**, unlock the trunk lid top latches. Lift the trunk storage lid. Remove prop rod from the retaining brackets located along the front. Insert the free end of the prop rod into the retainer on the trunk lid to hold it in the open position. **Side access** to the trunk area can be achieved by opening the side access door on the curbside of the trailer. Insert the key and turn clockwise to open.

### **IMPORTANT:**

- This compartment is rated to carry a maximum of 150 pounds, evenly distributed.
- This compartment is not intended for persons, animals, or flammable liquids.
- Do not use the top lid of this compartment as a load bearing surface.
- This compartment is equipped with gaskets and latches to prevent the intrusion of dust and moisture into the compartment when closed. Properly latched, the compartment door gasket will work effectively in keeping dust and moisture out of the compartment under most conditions.

- Moisture or dust may enter the compartment under severe conditions, or if the latches are not properly engaged, or if the gaskets are damaged. Condensation may accumulate inside the box given certain conditions, and condensation may transfer to compartment contents. Contents susceptible to damage from dust or moisture should be packed accordingly.
- This compartment is equipped with a drain plug to permit drainage of wash water should washing of the compartment interior be desirable.

## **FRONT TRUNK LIGHTING**

For models equipped with front trunk storage, interior lighting is provided to allow visibility in low lighting situations such as evening arrival at campgrounds. Locate the rocker switch inside the side access door and turn the switch to the "ON" position to activate the interior light.

## **SHOWER**

### **SHOWER CURTAIN**

Install the shower curtain hooks to the shower curtain rod and attach the curtain to the sliding loops. Secure the shower curtain rod to the top assembly with the nylon retaining straps.

### **INSIDE SHOWER OPERATION**

Connect a garden hose (not supplied) to the tub drain located on the lower portion of the exterior body panel and route to a park-supplied drainage receptacle or a suitable waste container.

**NOTE:** There is an adapter provided in the parts package inside the trailer which will screw onto the shower drain to connect the garden hose.

Connect the shower head hose to the tub faucet fitting and hand tighten. Attach shower head to retaining bracket. Adjust the shower curtain to ensure that the total area around the tub is sealed and the curtain bottom is inside the tub. Open hot and cold faucets 1/4 turn and adjust to comfortable temperature and pressure desired. If using the built-in water tank, ensure the +12 VDC electric water pump is turned on to supply adequate pressure.

**NOTE:** When your trailer is being stored for extended periods of time, it is recommended that the shower curtains be removed from the unit, folded, and stored indoors under fairly constant temperatures. Extremes of temperatures could have an adverse effect on the plastic material.

### **OUTSIDE SHOWER OPERATION (where applicable)**

Open the shower access door, located on the side body panel, and swing shower head out away from the panel. Slowly open faucet control knobs. Turn or depress the control lever on top of the shower head to allow water to flow. Lift the shower head off of the retaining bracket to allow the shower to be utilized away from the trailer. Gently pull the shower head and hose to desired length.

**NOTE:** Either city water supply or the electric pump system must be in operation to allow water to flow to the outside shower.

## **WARNING**

The hot water drawn at the shower is directly out of the water heater. Hot water can produce third degree burns in six seconds at 140°F (60°C) and in thirty seconds at 130°F (54°C). Thermostats are factory set at 120°F (48.9°C) or less. Contact qualified service personnel for adjustments.

Scalding could occur if the hot water temperature is over 125°F (52°C) and is not diluted. DO NOT expose the body directly to the undiluted hot water. Children, disabled, or elderly are at high risk of being scalded. Test water temperature before bathing or showering.

## **CASSETTE TOILET (where applicable)**

Please consult the operating instructions furnished with your Owner's Information.

## **TOILET (where applicable)**

Specific models may be equipped with a marine type toilet. A foot-operated pedal allows a valve in the bottom of the bowl to open permitting the contents to be flushed into a holding tank. A stream of water under pressure from the trailer's water system swirls around the bowl cleaning it and flushing the contents into the holding tank.

For additional information, please consult the operating instructions furnished with your Owner's Information.

## **DUMPING THE HOLDING TANKS – BLACK/GRAY**

The holding tanks terminate in a valve arrangement that permits dumping the tank when needed. The valves are called "knife valves". A blade closes the opening in the sewer drain pipes. The blade is connected to a T-handle that is pulled to release the contents of the tank.

**NOTE: Do not pull the holding tank knife valve open when the protective cap is installed on the pipe.**

**NOTE: Always ensure that the tank is evacuated into an acceptable sewer inlet or dump station.**

Dump the holding tank only when it is about two-thirds full. If necessary, fill the tank with water to about two-thirds full. This will provide sufficient water to ensure complete flushing of waste material into the sewer line. Whenever possible, dump the holding tank before traveling. Waste water in the holding tank will reduce the cargo carrying capacity of the trailer.

## **WARNING**

Holding tanks are enclosed sewer systems and as such must be drained into an approved dump station. Black water holding tanks must be drained and thoroughly rinsed to prevent accumulation of harmful or toxic materials.

The holding tank outlet is set up to be used with a removable fitting that locks onto the outlet with a clockwise twist. The sewer drain hose is clamped to this fitting when you need to drain the holding tanks. When you are operating self-contained, or you store the trailer, install the protective cap in place of the removable hose.

When you want to drain the holding tanks:

- Attach the hose to the dump valve. Extend the hose and insert the end of the hose into the sewer or dump station inlet, pushing it firmly far enough into the opening to be secure. In some cases, adapters may be necessary between the line and the inlet. Arrange the sewer hose so it slopes evenly and is supported to maintain the slope.
- To dump the holding tank, grasp the handle of the black water knife valve firmly and slide the valve open with a quick, steady pull.



- Allow enough time for the tank to drain completely. Rinse and flush the tank and drain hose through the toilet with a bucket of water or a hose. When the tank flow stops, push the handle in to close the valve.
- Remove the sewer hose and replace the cap.
- Rinse out the sewer hose with fresh water and remove the sewer hose from the dump station.
- Replace sewer or dump station covers.
- Store the sewer hose.

If you are parked at a site with a semipermanent sewer hookup, keep the black water knife valve closed to allow the waste level to build up. The outlet will probably clog if you leave the knife valve open continually. Run enough water into the tank to cover the bottom. This will aid the break up of solid wastes.

*Please ...practice good housekeeping when draining wastes at a campsite or disposal station. Leave the site in good order. Above all, do not pollute.*

## **HOLDING TANK CARE AND MAINTENANCE**

Since holding tanks don't rely on any sophisticated mechanical devices for their operation, they are virtually trouble-free. The most common problem is also an unpleasant one - clogging. You can minimize the chances of clogging by keeping the following considerations in mind:

- Keep the black water tank knife valve closed. Fill tank to at least 2/3 full before dumping. Be sure to cover the tank bottom with water after dumping.
- Use only toilet tissue formulated for use in septic tank or RV sanitation systems.
- Keep both knife valves closed and locked, and the drain cap tightly in place when using the system on the road.
- Use only cleaners that are approved for use in septic tank or RV sanitation systems.
- Use a special holding tank deodorant chemical approved for septic tank systems. These chemicals aid the breakdown of wastes and make the system much more pleasant to use.
- Do not put facial tissue, paper, grease, ethylene glycol-based or other automotive antifreeze, sanitary napkins, or household toilet cleaners in the holding tank.
- Do not put anything solid in the tank that could scratch or puncture the tank.
  - If the drain system does get clogged:
  - Use a hand-operated probe to loosen stubborn accumulations.
  - Seriously clogged P-traps may require disassembly. Be careful not to over tighten when reassembling.
  - Do not use harsh household drain cleaners.
  - Do not use motorized drain augers.
  - Sometimes the holding tank valve will get clogged. In this case, a hand-operated auger may be necessary. Be ready to close the valve quickly once the clog is cleared. If the seal gets damaged, it must be replaced.

## **RANGE/OVEN (where applicable)**

The propane oven and burners are operated with propane. The basic operation is the same as the range/oven in your home. For additional information, please refer to the operating manual in your Owner's Information Package. A warning label has been located in the cooking area to remind you to provide an adequate supply of fresh air for combustion. Proper ventilation when cooking will prevent the dangers of asphyxiation.

## INSIDE GALLEY STOVE USE

Unfasten the catch securing the stove cover. Raise the stove cover into position. Rotate the splash guard and secure to the side of the cook top. **Check to ensure all burners on the stove unit are turned off.** Open the valve on the propane cylinder all the way by rotating handle in counterclockwise direction. Light a match and hold near the propane burner. Slowly open one propane burner until flame ignites. Do not turn the propane burner on high as an unusually high flame may occur when lit. If the match blows out, turn the propane burner off and repeat lighting sequence.

**NOTE:** Initially, it may take 20-40 seconds for the propane to flow from the propane cylinder to the burner after which the propane burner will ignite.

**IMPORTANT:** Do not place hot cooking utensils on cabinet tops or table top. Damage to surface could occur. Do not use stove unless the drapes are secured to the galley back with the Velcro tabs or to the plastic drape track behind the upper galley assembly.

### **WARNING**

When the trailer has been over rough terrain, the LPG piping and appliances should be checked by an authorized LPG supplier for leaks. **DO NOT** attempt to test with a lighted match. **DO NOT** tamper with the LPG cylinder regulator, it is factory adjusted. Failure to adhere to this warning could lead to an undetected LPG leak resulting in fire and/or explosion.

Authorized LPG suppliers should not check copper and brass plumbing lines and fittings for leaks using ammoniated or chlorinated household type detergents. These can cause cracks to form on the line and brass fittings.

## OUTSIDE STOVE USE (Optional)

### OUTSIDE STOVE

Remove the stove from storage location. Swing support leg into position away from the stove bottom. Using both hands tilt the front side up slightly and place stove retaining bar onto mounting bracket located on the curbside body panel and lower stove unit until support leg rests against body panel. Ensure outside stove is fully engaged onto the mounting bracket.

**IMPORTANT:** The outside stove counter top could be damaged by exposure to rain, excessive moisture, or extended periods of sunlight.

Attach LPG line from stove to connection located at the bottom flange of curbside rear panel. All LPG connections should be tight.

Open stove cover and secure the splash guards. The outside stove is now ready for use.

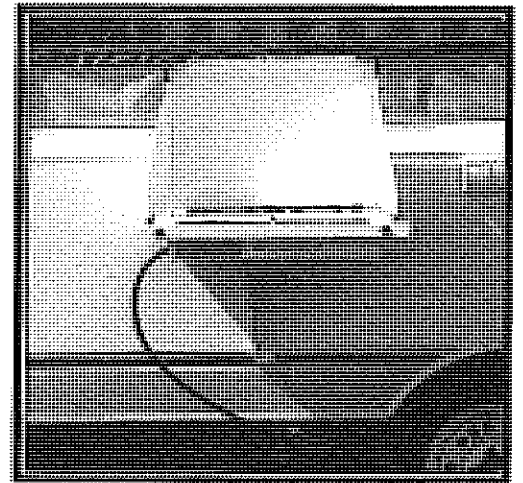

**Outside Stove**

### **WARNING**

This stove connection should **NOT** be attached directly to any other unregulated LPG source. Care should be used when disconnecting LPG. Never disconnect the stove valve while smoking or with an open flame nearby. A small amount of LPG will be released from the disconnect. Fire or explosion may occur if the LPG contacts the open flame.

**WARNING**

Maximum weight to be placed on the cook top of the stove should not exceed 25 pounds. Failure to comply could result in damage to the stove or injury. Keep all flammable objects from open flame or hot burner surface. If an LPG leak is suspected, contact an authorized LPG supplier for assistance. Never attempt to check LPG systems by yourself as fire or explosion may occur.

Follow instructions in reverse order to store stove.

**BBQ GRILL (Optional)**

Carry the BBQ Grill outside the trailer. Holding the BBQ hanger with both hands, tilt the front side up slightly and engage the BBQ hanger onto the retaining bracket located on the curbside (door side) of trailer. Carefully slide the BBQ onto the hanger and secure. Engage the BBQ propane line onto the propane quick disconnect located at the bottom flange of curbside panel.



*BBQ Grill*

**WARNING**

This connection should NOT be attached directly to any other unregulated propane source. Care should be used when disconnecting propane. Never disconnect the stove valve while smoking or with an open flame nearby. A small amount of propane will be released from the disconnect. Fire or explosion may occur if the propane contacts the open flame.

**WARNING**

This BBQ grill is very hot while in operation and may remain hot even after the burner has been turned off.

**WARNING**

Maximum weight to be placed on the cook top of the BBQ Grill should not exceed 25 pounds. Failure to comply could result in damage or injury. Keep all flammable objects from open flame or hot burner surface. If an LPG leak is suspected, contact an authorized LPG supplier for assistance. Never attempt to check LPG systems by yourself as fire or explosion may occur.

Connect garden hose from city water inlet to park supplied water outlet. (See water system for additional details.)

**HINT:** An optional water pressure regulator is recommended at all times to protect your water system from unregulated sources.

Plug 30 amp power cord into park supplied receptacle.

**REMINDER:** Upper galley must be positioned atop the lower galley cabinet to depress the "kill" switch to activate +12 volt light system.

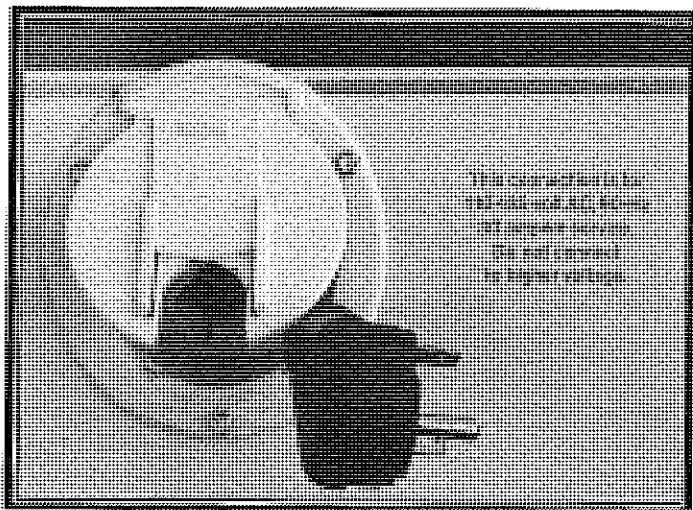

**30 Amp Power Cord**

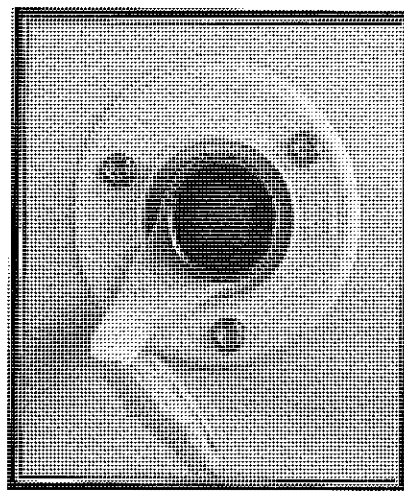

**City Water Inlet**

## **FURNACE (Optional)**

The furnace is a forced air unit fueled by propane and electricity powered by 12 volts DC. All furnaces are equipped with a thermostat, and contain an on/off switch. During the initial lighting of a furnace, smoke and fumes may be created as a result of the burning off of manufacturing compounds. This is normal, however, the windows and doors should be open for proper ventilation during the burn-off process. The operating manual included in your Owner's Information Package contains detailed operating and maintenance instructions.

## **REFRIGERATOR (Optional)**

The refrigerator may be operated from either propane, 120 volt AC, or 12 volt DC depending upon availability and your preference. Refer to the operating instructions furnished in your Owner's Information Package for detailed instructions.

## **MICROWAVE OVEN (where applicable)**

The microwave is powered by 120 volt AC power and will only operate when the trailer is connected to a 120 volt AC source.

## **AM/FM STEREO (where applicable)**

The AM/FM stereo radio is powered by 12 volts DC. Please consult the operating instructions furnished in your Owner's Information Package.

# TAKE-DOWN INSTRUCTIONS

Unplug the power cord and store. Shut off the water supply and disconnect the city water hook-up. Attach the protective cap onto the external city water connector. Close the propane valve on the propane cylinder.

## **WARNING**

Do not attempt to operate any liquid propane appliances while the trailer is in tow.

From inside the trailer, open and light one propane burner and allow to burn until flame extinguishes. This will safely and effectively bleed the system. **Turn propane burners to "OFF"**. Allow stove burners to cool. Lower the stove cover and secure for travel.

**NOTE:** On models equipped as such, ensure removable inside/outside stove is locked into the upper galley or storage position. Never store stove assembly when hot.

**HINT:** Rinse any waste water hoses with clean water prior to storage. This will help reduce odors. Store waste water hoses separately from fresh water hoses. Do not interchange hoses.

Close all drapes completely and remove safety ties/Velcro tabs from behind the galley. Detach both front and rear bed bow supports from the metal roof retainer and from the bed bow and stow under each mattress. Ensure all window flaps are zipped and closed. Detach glide-out compartment and tip-out galley tent supports from roof or bay window (where applicable) and store under front mattress or dinette seat bench.

Lift the dinette table up on end. Apply inward pressure to the leg support locks and retract and secure legs with the strap over both dinette legs. Secure the dinette table by locating it between or on top of the bench seats. Store seat cushions on seat bench frame and backrest cushions face-down on the table. On glide-out models, two cushions store under the collapsed dinette table and two in front of the glide-out sofa.

Lower shower curtain and return cassette/shower counter top lid to the travel position (over top of the shower cabinet).

Return all interior mounted accessories such as camper caddies, vanities, wardrobes, etc., to their travel positions.

Swing or flip-over hinged upper galley assembly to the travel position on floor. A protective pad or rug may be placed atop the floor to protect the linoleum. Ensure stove cover and stove assembly (where applicable) are secure. Return the storage shelves or expanda-bed to the travel position.

**NOTE:** On flip-over galleys a small amount of water may be expelled from the P-trap when the galley is turned over. A protective pad or rug may be placed atop the floor to protect the linoleum from the galley grab handle.

Beginning at the top of the screen door frame, carefully unfasten the Velcro on either side of the door frame and unfasten tent Velcro patches from outer door frame and body rails.

**NOTE:** Ensure all removable and sliding window panes have been returned to their original closed position prior to storing screen door.

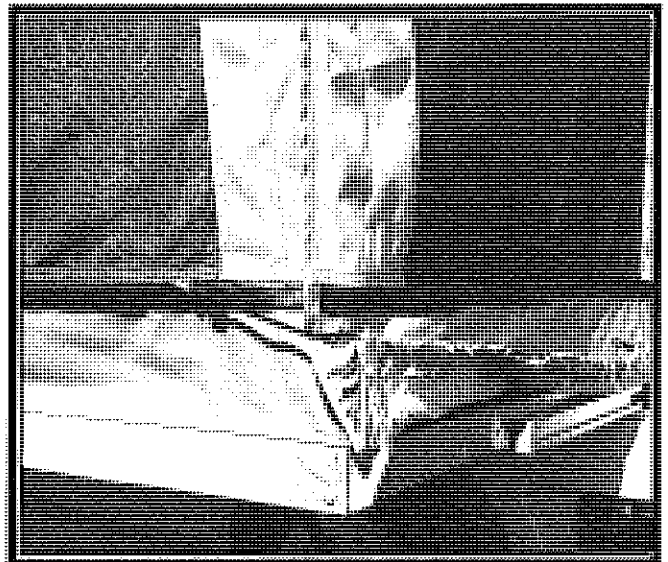

**Tent Flap**

Step inside the trailer and release the screen door retainers. Step outside the trailer and lock the screen door latch. Lift up and remove the door from the threshold and move door inward. From outside the trailer, grasp the bottom of the door frame, lift up and push the top of the door toward the far side of the trailer. Place the bottom of the door onto the pins on the retaining bracket and lock spring-loaded pin clip into base of door frame and snap web retaining straps. Be certain door is securely engaged on retaining bracket.

Ensure Velcro patches sewn onto tenting at doorway opening are clear of the bed slides when closing the beds.

**NOTE:** On glide-out models, the glide-out compartment must be closed and secured prior to closing the beds.

**Where applicable:** From outside the trailer, attach glide-out body rail flap to the three individual pieces of Velcro located along the top side of the body rail. Remove Velcro on tenting from Velcro strips on side of glide-out and Velcro patches from body rails. Ensure glide-out bay window tent support bow is lowered onto the dinette seat bench by reaching under tenting and grasping bow. While holding end of tenting, push bow towards center of trailer until bow lays onto seat bench compartment. Be careful not to pinch fingers under bow. (It may be necessary to disengage tenting from around the bow.) Ensure tent fabric is clear of metal body rails. Lightly lift up on the two inner "grab" handles and push the glide-out compartment against the main body panel. (Ensure lock arms are retracted.) Locate the two locking handles on the outside edge of the glide-out compartment. Rotate the lock handles 90° to engage the lock arms. Push in on the lock handles to secure glide-out and lock the handles against the outside of the glide-out compartment. **Do not attempt to close the glide-out compartment from inside the trailer.** Carefully pull all glide-out tenting to outside the trailer. Where applicable, ensure tip-out tenting hangs to outside of trailer.

**Beginning with the bed most distant from the access door:** From outside the trailer, release the stretch cords from the hooks located under the extended bed. Detach tenting from Velcro pads at the end of the body rails. Pull the tent flap up and over the bed edge at sides. Attach the hook end of the stretch cord to the loop as shown in the "Tent Flap" photo.

**NOTE:** If bed bow does not fall onto mattress, reach under tenting and grasp bow. While holding tenting at end of bow, push bow toward center of trailer until it lays flat on mattress.

Pull tenting away from bed bows and **ensure that the tent material is clear of bed slides to prevent pinching of tenting.** Raise the bed slightly and remove the lower bed supports from the pegs on the frame or bumper. **On models equipped with back saver bed legs:** Raise the bed slightly and push down on the catch mechanism's release lever. Slide bed supports outward and remove the bed leg from the frame or bumper.

Swivel each bed support up and lock into the travel position under the bed. (The bed does not need to be raised to lock in supports.)

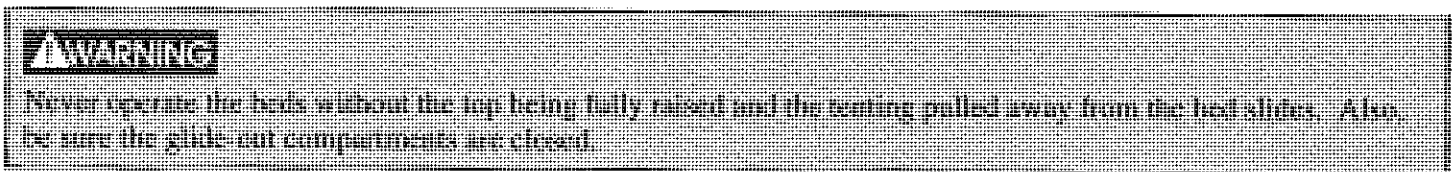

From the center of the bed, return bed to travel or closed position by placing hands on the bed frame and gently pushing inward until the bed lightly hits the stops. **If resistance is encountered before bed hits the stop, recheck bed rail area to ensure clearance. Do not force!** From inside the trailer, distribute tenting evenly on mattress to lay as flat as possible. Move to opposite bed and repeat above procedure. Ensure either bed did not push out during this step.

Tuck glide-out tenting into trailer to lay flat as possible on beds; fold sides back against glide-out tenting. Attach glide-out rail flap to Velcro on rail. Tuck tip-out tenting into trailer.

Make sure the trailer tongue jack is down and locked into position. Release the stabilizers but do not completely retract. If the optional canopy is set-up, reduce tension on guide ropes and allow adequate slack to close top assembly.

**HINT:** To keep your vinyl floor covering looking new, it is advisable to place a throw rug or carpet on the floor covering directly underneath the area in which the galley will rest during transit.

### **CAUTION**

Be sure the tongue jack is supporting the trailer tongue and is locked in position to prevent sudden collapse of trailer tongue.

### **WARNING**

Stand clear of the trailer when pressing on the quick-release lever on the swing-down stabilizers. The trailer will drop when it is released. Do not lie under the trailer when releasing or lowering the stabilizers. Bodily injury could result due to the quick drop of the trailer if these warnings are not followed.

**IMPORTANT:** Do not lower top unless the stabilizers are released.

## **CRANK-DOWN STABILIZERS**

Raise stabilizers to travel position by rotating crank handle counterclockwise. Once the stabilizer is completely raised, over-crank 1/4 of a turn to lock the stabilizer in the raised position. Failure to lock the stabilizer in the raised position could result in accidental descent of the stabilizer while traveling.

## **SWING-DOWN STABILIZERS**

To raise the swing-down stabilizers, press on the quick release lever with the jack handle. Slide inner leg completely up and raise stabilizer to travel position. Ensure stabilizer is in the locked or travel position.

## **CRANK-UP/CRANK-DOWN LIFT**

Rotate the crank handle in a counterclockwise motion and lower the top to within two feet of the trailer body. Turn crank handle clockwise until a click is heard to prevent the top from closing further.

On all models, lean inside trailer at access door and pull both bed tents by top vinyl toward center to lay flat on the mattresses. From front to rear of trailer, push in side tenting towards center of trailer. Move along side of trailer while continuing to push the tenting inward. Lower the top to within one foot of trailer body. Turn crank handle clockwise until click is heard to prevent top from closing further. Repeat previous motion to push-in any remaining exposed tenting. Lower the top to trailer body. No tenting should be exposed.

**IMPORTANT:** If the top will not seat properly onto the trailer, raise the top and repeat closing procedure. **DO NOT FORCE!**

**NOTE:** Pushing down on the center of the top assembly front and rear before attaching the top latches will ease the closing procedure.

Walk around trailer to ensure no tenting is exposed. Roll up canopy and poles and store in travel bag.

### **WARNING**

Never pull out or push in beds without the top being fully raised and the click-out compartment closed.

Secure crank handle; close and lock the access door and latch all four top latches on the roof. Where applicable, ensure front trunk storage lid, glide-out compartment, and side access doors to the trunk area are locked and secured. Adjust the tongue jack so that the trailer tongue is higher than the vehicle hitch ball. Back the vehicle close to the trailer and set brake. Using the tongue jack, lower the trailer tongue onto the ball hitch of the vehicle. Engage the coupler release handle by pressing down into the locked position. The coupler has a hole in it for a safety clip or padlock to be inserted for trailer theft protection. Install safety pin and clip or pad lock. Retract the tongue jack wheel fully by turning the handle counterclockwise until it stops, pull the release pin and swing the tongue jack up to the travel position. Bring the tongue jack handle up and over the tongue jack to store.

### **⚠WARNING**

Failure to ensure that the trailer coupler is properly engaged and latched on the ball hitch could result in the trailer disconnecting from the tow vehicle. A vehicular accident could occur.

Attach the safety chains to the tow vehicle receiver so they "criss-cross" under the ball. Remove and store wheel chocks. Connect the +12 volt trailer electrical pigtail to the mating +12 volt plug on the tow vehicle. Check to see that all lights on the trailer are functioning properly. Ensure all cargo items are securely fastened.

Where applicable: Attach safety cable for electric brake system.

## **LIQUID PROPANE SYSTEM**

This system has been checked at our factory and by your dealer to ensure its safety. Except for the simplest maintenance, this system should be checked by an authorized propane supplier should any problems be suspected. The propane system should be checked each time a propane bottle is changed, every 30 days, after traveling over rough terrain, and prior to using after periods of storage. Due to the importance of this system and the safety precautions built into it, we feel it best to take a little time to describe it to you.

The following warning label has been located in the cooking area to remind you to provide an adequate supply of fresh air for combustion.

### **⚠WARNING**

**COOKING APPLIANCES NEED FRESH AIR FOR SAFE OPERATION. BEFORE OPERATION, OPEN A WINDOW.** Unlike homes, the amount of oxygen supply is limited due to the size of the recreational vehicle, and proper ventilation when using the cooking appliances will avoid dangers of asphyxiation. It is especially important that cooking appliances not be used for comfort heating as the danger of asphyxiation is greater when the appliance is used for long periods of time.

Carbon monoxide is a colorless, tasteless, odorless gas. It is a by-product of the burning of fossil fuels (gasoline, liquid propane, diesel fuel, etc.). The engines in your tow vehicle and generator (if equipped), furnaces, water heater, propane refrigerator, and range produce it constantly while they are operating. **CARBON MONOXIDE IS DEADLY.** Please read and understand the following precautions to protect yourself and others from the effects of carbon monoxide poisoning.

Beware of exhaust gas (carbon monoxide) poisoning symptoms:

*Dizziness*  
*Intense headache*  
*Weakness and sleepiness*

*Nausea*  
*Vomiting*  
*Muscular twitching*

*Throbbing in temples*  
*Inability to think coherently*



If you or others experience any of these symptoms, get out into fresh air immediately. If symptoms persist, seek medical attention. Shut down the folding trailer and do not operate until it has been inspected and repaired.

### **WARNING**

1. Exhaust gases are deadly. Do not block the exhaust ports, or operate the vehicle in a place where the exhaust gases have any possibility of accumulating either outside, underneath, or inside your vehicle or any nearby vehicles. Outside air movements can carry exhaust gases inside the vehicle through windows or other openings remote from the exhaust outlet. Operate carbon monoxide-producing systems only when safe dispersion of exhaust gases can be assured. Monitor outside conditions to be sure that exhaust continues to be dispersed safely.
2. A warning label has been located near the propane cylinder. This label reads: **DO NOT FILL CONTAINER(S) TO MORE THAN 80 PERCENT OF CAPACITY.** Failure to comply could result in fire or personal injury. Overfilling the propane cylinder can result in uncontrolled propane flow that can cause fire or explosion. A properly filled container will contain approximately 80 percent of its volume as propane.
3. Do not modify or alter the propane plumbing system.
4. If any appliance or piping has been serviced, ensure that a system leak check has been performed by a trained technician. This should be verified before taking delivery of the unit.

### **WARNING**

1. Propane cylinders, gasoline, or other flammable liquids shall not be placed or stored inside the trailer; accidental fire or explosion may result. Propane cylinders are equipped with safety devices which relieve excessive pressure by discharging propane to the atmosphere. Always store propane cylinders outside with valves closed and plugged/capped.
2. Portable fuel-burning equipment including wood and charcoal grills and stoves, shall not be used inside the recreational vehicle. The use of this equipment inside the recreational vehicle can cause fires or asphyxiation.
3. Do not bring or store propane cylinders, gasoline, or other flammable liquids inside the vehicle because a fire or explosion can result.

## **LIQUID PROPANE CYLINDER**

The propane is stored under pressure in the propane cylinder located on the tongue of your trailer. This cylinder should be kept free of rust at all times. If rust should develop on the cylinder, the area should be cleaned completely of the rust, primed, and repainted white. Quite naturally, the service valve on top of the tank should always be closed when the tank is not in operational use, and especially when in transit. Position propane cylinder with safety valve pointing away from trailer.

### **WARNING**

Do not smoke while changing the propane cylinder and extinguish all surrounding open flames to avoid the possibility of fire and/or explosion.

**⚠ WARNING**

Your trailer has been equipped with propane cylinders that feature an overfill protection device (OPD). NFPA 58 (propane gas code) states that these portable cylinders shall not be filled without this device.

Do not use an older non-OPD cylinder. Inadvertently overfilling can result in fire or explosion.

**To change a propane cylinder:** Turn off the propane at all burners. Close the valve on the propane cylinder by turning it in a clockwise direction. Disconnect the wrenchless right-handed acme nut by turning counterclockwise. U.S. and Canadian configurations use a flexible rubber hose from the propane cylinder to a permanently mounted regulator on the propane bottle support angle. (Note: Internal propane cylinder POL valve threads are left-hand threads used for filling the tank.)

Loosen the T-handle or wing nuts from the J-bolts and remove the empty propane cylinder. Carefully place the full propane cylinder on the tongue support and secure with the J-bolts and wing nuts previously loosened. Reattach the wrenchless acme nut to the propane cylinder POL valve by turning clockwise, hand tighten, and ensure that the flexible propane hose is not twisted or kinked. All propane fittings should be checked and cleared of all dirt and debris prior to reattachment. Open the valve by turning it in a counterclockwise direction slowly. For Canadian or CSA trailers only, a secondary propane shut-off valve is located next to the permanently mounted regulator. This valve must also be turned "OFF" when using the interior stove assembly for outside cooking. *We suggest that all propane system fittings in the trailer be checked for leaks by an authorized propane supplier each time a propane cylinder has been changed, every 30 days, or after the trailer has traveled over rough terrain.* If a propane leak is suspected, contact your Fleetwood Folding Trailer Dealer or propane supplier for assistance.

**NOTE:** Ensure all appliances are turned "OFF". After exchanging an empty propane cylinder with a full propane cylinder, open the cylinder valve fully and wait approximately one minute for the propane system to recharge before attempting to light any propane appliance. Otherwise, the appliance may not light or experience insufficient propane pressure due to the built-in safety propane flow limiting device (located inside the acme nut connector) not resetting properly.

**⚠ WARNING**

Authorized propane suppliers should not check copper and brass plumbing fittings for leaks using ammoniated or chlorinated household type detergents. These can cause cracks to form on the line and brass fittings.

Additional fittings are required to the propane system as appliances are added, i.e., water heater, furnace, refrigerator. Therefore, any time the propane system is altered, the complete propane system should be rechecked for leaks. If a leak is suspected in the trailer, or the propane leak detector sounds, a distinctive odor (rotten eggs) will be noticeable. Should this be encountered, follow these directions:

**⚠ WARNING****IF YOU SMELL PROPANE:**

1. Extinguish any open flames, pilot lights, and all smoking materials.
2. Do not touch electrical switches.
3. Shut off the propane supply at the container valve(s) or propane supply connection.
4. Open doors and other ventilating openings.
5. Leave the area until odor clears.
6. Have the propane system checked and leakage source corrected before using again.
7. Failure to comply could result in fire or personal injury.

## LIQUID PROPANE CYLINDER REGULATOR

The propane cylinder regulators are the heart of your propane system. Propane regulators are an automatic device with working parts which move continuously. Consequently, they require more care, protection, and attention than any other part of the system. The basic function of a propane regulator is to take a high and varied inlet pressure from the propane cylinder and reduce it to a safe and consistent outlet pressure to the propane appliances. Whatever the pressure is in the propane cylinder, and it will vary due to atmospheric conditions, a low pressure propane regulators job is to reduce it to 6.35 ounces or 11" water column outlet pressure. The high pressure propane regulator will reduce the propane cylinder pressure down to 16 P.S.I. Do not interchange appliances between the two propane systems. Each is rated at different BTU output. Both propane regulators supply fuel downstream at the various propane pressures in whatever volume is required to efficiently operate each appliance as the demand is made.

The propane regulators are equipped with a vent because they are constantly "breathing." That is, the diaphragm of the propane regulator moves down and draws air into the bonnet or adjustment spring housing. When the diaphragm moves up, the air is expelled through the vent. In the event that excess pressure builds up in the lower housing or body of the propane regulator, a relief mechanism vents it to the atmosphere. For this reason propane regulators that are not in compartments have been equipped with a protective cover.

Make sure that propane regulator **vents face downward** and that covers are kept in place to minimize vent blockage that could result in excessive propane pressure causing fire or explosion. It is imperative, therefore, to check the vents frequently to be sure they are clean and free of water, corrosion, or obstructions as clogging is the most common cause of propane regulator malfunction. If the vents become clogged, they can easily be cleaned with a toothbrush. In addition, your propane regulators should be checked periodically by a qualified propane service technician to be sure that they are properly adjusted and in safe working condition. By following these simple precautions, your propane regulators will give you years of trouble-free service.

### WARNING

Propane regulators must always be installed with the regulator vent facing downward. Regulators that are not in compartments have been equipped with a protective cover. Make sure that the regulator vent faces downward and that the cover is kept in place to minimize vent blockage that could result in excessive propane pressure causing fire or explosion.

## LIQUID PROPANE REGULATOR FREEZE-UP

A propane regulator does not freeze, nor will propane; however, as the propane passes through the propane regulator, it expands and cools, and moisture in the propane or in the propane regulator will turn into ice. This ice can build up and totally or partially block the orifice and thus partially or totally block the fuel supply. There are a number of things you can do to prevent this type of freeze-up:

1. Before it is filled, be sure the propane cylinder is totally free of moisture by drying any visible water around the valve area.
2. Be sure the propane cylinder is **not** overfilled. Insist that the bottle never be filled beyond 80% liquid level.
3. Keep the valves on an empty cylinder closed.
4. Have your propane dealer purge the cylinder if freeze-up occurs.
5. If necessary, have your propane dealer inject methyl alcohol in the cylinder.
6. Keep the propane cylinder in an upright position.

If a propane cylinder is overfilled, a built-in pressure mechanism on the bottle will allow excess propane to escape. It is imperative, therefore, that once bottles have been filled that they always be stored outdoors in an upright position where complete ventilation is possible. As an example, if a propane cylinder is filled during extremely low temperatures, an increase in temperature will allow the propane to expand and possibly trigger the release valve. The presence of this propane in a confined area could result in fire or explosion.

**NOTE:** Preventive maintenance on all propane appliances should include periodic cleaning as needed to remove dust, lint, etc., from burner tubes and air passages. Burner tubes and orifices should also be inspected frequently for obstructions such as insects/spider webs or other foreign matter that may cause a burner malfunction.

### **⚠WARNING**

The water heater and furnace combustion air exhaust parts may be extremely hot during water heater and furnace operation. Do not touch these exhausts or allow any material to come in contact with, or cover, either the air intakes or exhaust parts while operating the water heater and/or furnace.

## **LIQUID PROPANE LEAK DETECTOR**

The propane you use to cook, refrigerate, and heat with is combustible. Should a propane leak occur, when the propane reaches the detector in sufficient concentration, your detector will produce a pulsating alarm sound and the RED indicator will flash. This alarm (4 rapid beeps per second) will continue to sound until the propane has dissipated or until the mute button is pressed. **When the alarm sounds, follow the steps in the “LIQUID PROPANE CYLINDER” section of this manual to evacuate the trailer. Do not reenter the effected area until the alarm stops sounding. If the alarm sounds a second time after the propane is turned back on, leave the propane off and have a qualified propane Dealer or RV Service Center make the necessary repairs.** The mute button only stops the alarm from sounding for 60 seconds. This detector only indicates the presence of liquid propane at the sensor. Liquid propane may be present in other areas. **This device is intended for detection of propane ONLY.**

### **⚠WARNING**

The propane leak detector/alarm is powered by a 12 volt source. Any interruption in power will render this alarm inoperative. Always ensure power is supplied when appliances are in use.

### **⚠WARNING**

Do not cover or allow the propane detector to be obstructed. It may not detect propane if obstructed. Exposure of this propane detector to an intense electromagnetic field may produce unpredictable operation. For example, a radio transmitter in close proximity to the propane detector may cause the propane detector to malfunction when the transmitter is transmitting. Failure to comply to these warnings could produce a hazardous condition.

## **PROPANE SAFETY TIPS**

Rules to remember:

- Keep propane cylinders/tanks away from heat sources.
- Always store and transport unused cylinders with the service valve closed and plugged/capped.
- Never store, transport, or repair propane cylinders in enclosed areas. In addition to living area, this also includes garages, storage sheds, passenger vehicles, and tents.
- Regularly inspect “pigtailed” and other flexible hoses for signs of cracks or abrasion. Replace them before they become old enough to develop leaks.
- Never use a cylinder if it shows signs of dents, gouges, bulges, fire damage, corrosion, leakage, excessive rust, or other forms of external damage.

**For further details refer to respective appliance manual.**

# WATER SYSTEMS

---

Fresh water may be supplied to your trailer sink (and shower unit where applicable) from one of two sources: the built-in water tank or the city water hookup. Fixtures for both of these are located on the roadside body panel and are marked accordingly.

## CITY WATER

When the campsite provides a pressurized water system: Remove the protective cap from the external city water inlet. Attach a non-toxic garden hose (not furnished) between the external trailer city water inlet and the (campsite-furnished) water outlet.

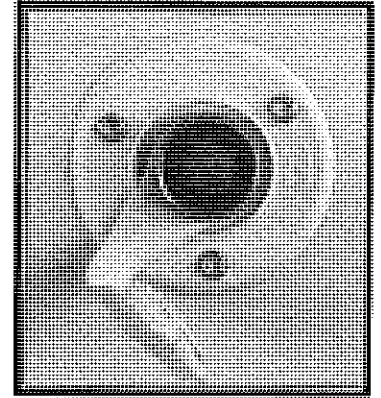

*City Water Inlet*

**IMPORTANT:** Since water pressures at campgrounds vary, we recommend installation of an in-line water pressure regulator (not supplied with trailer) at the water supply outlet. This will protect both the trailer water system and your supply hose from excessively high water pressure.

When the city water inlet is used, it will bypass the built-in water tank with the exception of the water heater only. In order to be sure the water heater is filled, it is wise to open the hot water faucet slightly to allow the escape of trapped air. This must be done before attempting to light the water heater.

## WATER TANK

If the campsite does not provide a pressurized water system, it will be necessary to use the trailer's built-in water tank system. In order to fill the non-removable water storage tank, open the exterior fill spout and slowly fill the tank using a non-toxic hose or appropriate container. Removable five-gallon water storage bottle/s can be removed from inside the trailer and filled at a suitable water filling station.

To ensure complete sanitation of the potable built-in water system, we suggest the following procedure be used on a new system, one that has not been used for a period of time, or one that has become contaminated. Prepare a chlorine solution using one gallon of water and 1/4 cup of Clorox® or Purex® household bleach (5% sodium hypochlorite solution). Close all drain valves and faucets. Pour one gallon of solution into tank. Complete filling of tank with fresh water. Where applicable, turn on the +12 volt electric water pump or pump the handle on the hand faucet. Open the faucets individually until all air has been released from the pipes and entire system is filled. Pump water up to the sink and shower. Allow to stand for three hours. Drain the entire system by opening all valves and faucets. Flush with potable fresh water for several minutes to flush out the chlorine solution. After flushing, close all drains and faucets. Refill the built-in tank with fresh potable water. The system is now ready to use. To remove any excessive chlorine taste or odor which may remain, prepare a solution of one quart vinegar to five gallons water and allow solution to agitate in the tank for several days by vehicle motion. Drain tank and again flush with fresh potable water.

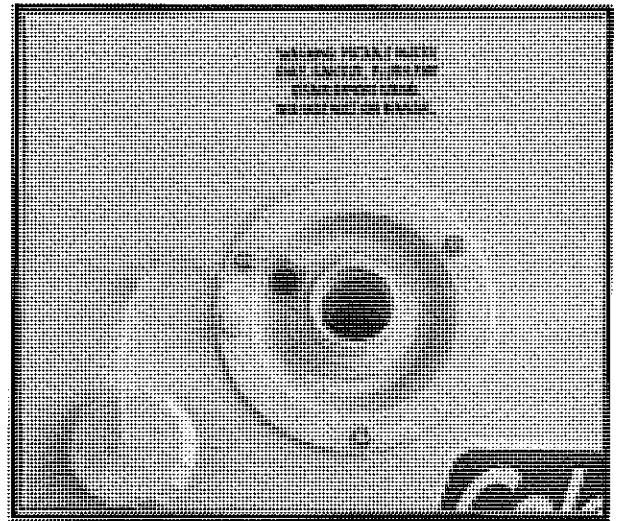

*Exterior Water Fill Spout*

Once the built-in water system has been cleaned, flushed, and refilled, water can be pumped by raising and lowering the hand pump handle or opening the mixer faucet hot/cold knobs.

## SINK DRAIN

The outlet port for the sink drain is located on the same side of the trailer as the sink and the location is identified with a "drain" decal affixed to the body panel. The sink can be drained by simply removing the plastic protective cap from this fitting and allowing the water to flow freely from the sink. Please note that this fitting is threaded to allow the fastening of an adapter or rubber hose in order to drain the sink into a park-provided facility or waste container. (The adapter is contained in the parts package provided with the trailer.)

### **WARNING**

Do not interchange the grey water system hose and fresh water system hose as contamination to the water supply could result.

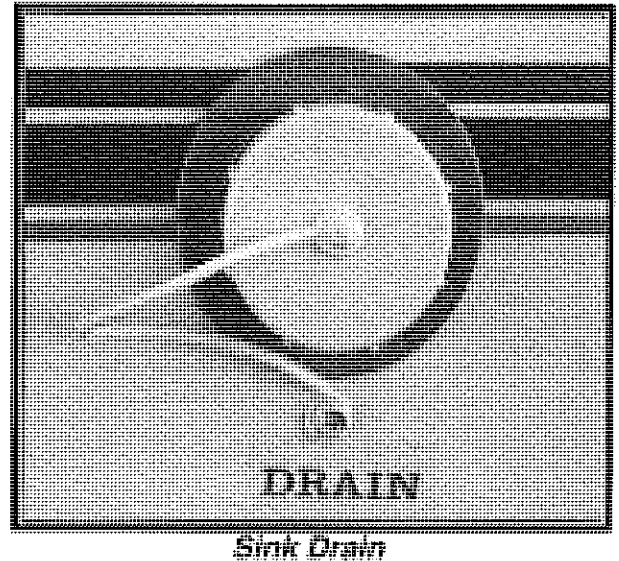

**HINT:** To improve drainage, keep auxiliary drain hose as short as possible, and eliminate kinks and twists. Your dealer can also obtain an auxiliary drain hose package which contains a 1 1/4" twelve foot drain line which attaches directly to the sink drain outlet.

## +12 VOLT ELECTRIC DEMAND WATER PUMP

The electric pump can be activated for use by pushing the switch button located on the lower galley top. Once the unit is activated, it will automatically switch on and off depending upon water pressure. Instructions for the specific care, use, and service of this component are enclosed with your trailer information package. This electric water pump is only to be used when a city water hook-up is not available and water must be drawn from the built-in water storage tank.

**IMPORTANT:** Do not allow the electric water pump to run when the water system is dry. Subsequent damage to the pump mechanism will result.

**NOTE:** The electric water pump is equipped with an in-line screen filter which is located on the inlet fitting of the pump. The filter should be cleaned periodically to ensure maximum pump efficiency. Contact your dealer for the removal of the filter and screen.

## HOT WATER SYSTEM (where applicable)

The hot water system in your trailer is a high-quality, versatile system. To acquaint you with the various methods of operation, a discussion of each follows:

### **METHOD 1:**

Connect a garden hose (not furnished) to the campground-provided water outlet and city fill hook-up connection on the roadside body panel of the trailer. Turn the city water supply "on" and allow the system including the hot water tank to fill. Light the water heater by following the instructions printed inside the vent cover or in the water heater operating instruction manual.

**IMPORTANT:** Where applicable, be certain that the water heater is filled prior to lighting to prevent appliance damage. Ensure the hot water heater bypass valve is completely open to allow cold water to fill the hot water heater.

Simply turn the sink or shower faucet knob approximately 1/4 turn to draw water.

## METHOD 2:

Fill the built-in water tank. Connect trailer exterior power cord to 110 VAC power supply. Engage the electrical demand pump by pressing the switch button located on the lower galley top or water level/battery charge indicator monitor panel. Once the hot water tank is filled and all faucets closed, the pump will automatically shut off. Light the water heater by following the instructions printed inside the vent cover. Simply turn the sink or shower faucet knob approximately 1/4 turn to draw water. The electric pump will automatically engage to provide needed water pressure. Due to the water draw during filling of the hot water heater, it will be necessary to refill the built-in water tank.

### **CAUTION**

Hotter water increases the risk of scalding injury. Before changing water temperature settings, see water heater owner's manual.

### **WARNING**

The hot water drawn at the shower is directly out of the water heater. Hot water can produce third degree burns in six seconds at 140°F (60°C) and in thirty seconds at 130°F (54°C). Thermostats are factory set at 120°F (48.9°C) or less. Contact qualified service personnel for adjustments.

Scalding could occur if the hot water temperature is over 125°F (52°C) and is not diluted. DO NOT expose the body directly to the undiluted hot water. Children, disabled, or elderly are at high risk of being scalded. Feel water temperature before bathing or showering.

Also, hydrogen gas can be produced in a hot water system served by this heater that has not been used for a long period of time (generally two weeks or more). Hydrogen gas is extremely flammable. To reduce the risk of injury under these conditions, it is recommended that the hot water faucet be opened for several minutes at the sink before using any electrical appliance connected to the hot water system or lighting any propane appliance. If hydrogen is present, there will probably be an unusual sound such as air escaping through the pipe as the water begins to flow. **THERE SHOULD BE NO SMOKING OR OPEN FLAME NEAR THE FAUCET AT THE TIME IT IS OPENED.**

When a 110 VAC power supply is not available, your water system may be used by connecting the trailer +12 VDC power supply plug to a tongue-mounted battery or tow vehicle +12 volt outlet, i.e., cigarette lighter.

**IMPORTANT:** Where applicable, be certain that the water heater is filled prior to lighting to prevent appliance damage. Ensure the hot water heater bypass valve is completely open to allow cold water to fill the hot water heater.

## **DRAINING AND WINTERIZING THE WATER SYSTEM**

Your dealer can advise you concerning specific winterization procedures and products for your climate area or the areas through which you will be traveling. Your dealer may also provide winterization service for all appliances and systems in the trailer. If you choose not to travel during the winter and will be storing your trailer during periods of freezing temperatures, follow a thorough winter storage procedure. Protecting the plumbing systems in your trailer is the most important aspect of long-term winter storage.

Extensive damage to the plumbing fixtures and components, as well as other potential problems, can be avoided by proper draining and antifreeze protection. Following are procedures for winterizing your vehicle yourself.

On units not equipped with a hot water heater or tub and shower unit, the water system may be drained by simply opening the drain plug located on the bottom of the built-in water tank under the trailer and allowing all water to discharge. Use the galley faucet/hand pump to drain remaining water out of the lines once the tank is drained.

On those units equipped with portable water bottles and not a built-in water tank, it is only necessary to drain the lines and simply empty the bottles.

On units equipped with a water filtration system, it is necessary to close the in-line shut-off valve and remove the water filter.

Drain the fresh water tank by opening the water tank drain plug. Leave valve open. Turn the electric water pump on (+12 volt DC power on). Open a cold water faucet. When the flow of water stops, turn the pump off. After opening hot and cold water faucets, open the drain valves on HOT and COLD water lines. These valves are located on the underside of the trailer. (Water line drain valves only applicable in trailers so equipped.) Drain the water heater by opening the drain valve at the bottom of the heater and open the safety valve. Open the hot water faucets. (Reference water heater instructions for exact location of drain valve.) When each faucet has been opened, drained, and closed, close the water line drain valves and freshwater tank drain plug. Disconnect the shower hose assembly. Be sure ALL water from ALL plumbing fixtures has been drained.

**IMPORTANT:** Draining the water system alone will not provide adequate cold weather protection. If the trailer is to be unheated during freezing temperatures, consult your dealer for the best winterizing procedure for your climate. Your dealer can winterize your trailer for you or can supply you with one of the special antifreezes which are safe and approved for use in RV water systems. Follow the instructions furnished with the antifreeze.

#### **WARNING**

Do not use automotive or windshield washer antifreeze in the trailer water system. These could be harmful if swallowed.

Pour approximately two gallons of non-toxic R.V. approved antifreeze into the portable or built-in water tank. Be sure tank drain plugs are installed. Turn the +12 volt water pump switch "ON". Open each cold water faucet, run the water pump and let about a cup of antifreeze solution flow continuously through each faucet. Close each cold water faucet. Check the antifreeze level in the water tank. Add antifreeze solution if necessary.

On trailers supplied with a hot water heater, turn the water pump switch "OFF". Completely drain built-in water tank and water heater. Remove the drain plug to drain the water heater. Close the hot water heater bypass valve to prevent antifreeze from filling the hot water tank. Pour approximately two gallons of non-toxic RV-approved antifreeze into portable or built-in water tank. Open all hot and cold water faucets to relieve pressure. Close all faucets. Turn water pump "ON". Open hot water faucet farthest away from built-in water tank. When antifreeze appears, let about one cup run down drain to winterize trap, then close faucet. Repeat this at all other hot and cold water faucets including the shower. Turn water pump OFF. Open water faucet to relieve pressure then close. Winterizing of the fresh water system is complete. Open hot water heater bypass valve.

When filling the plumbing systems with antifreeze, be sure to open and operate all fixtures and valves allowing the antifreeze solution to flow freely. Pour a cup of antifreeze solution down each sink and tub drain. Install all protective caps: water tank fill, city water inlet cap.

## **CHASSIS SYSTEM**

---

### **TIRES**

**PLEASE NOTE:** While the warranties of the various tire manufacturers vary in language, they provide that tires installed as original equipment at the factory are warranted to the owner to be free from defects in material and workmanship for one year after the retail sale or 33% of the tread wear, whichever occurs first. There is no warranty coverage for damages resulting from road hazards, improper inflation pressures, driving more than the maximum speed limit, or overloading the trailer beyond the maximum load capacity.



## **▲ CAUTION**

To provide maximum towing ease, tire life, and trailering safety, check the following items before each trip to and from the campsite:

1. Tires inflated to recommended pressure as indicated on the tire sidewall.
2. Wheel lugs securely tightened. (Refer to Wheel Torque Requirement chart on page 53.)
3. A visual inspection of tire tread and side walls for wear or cuts.
4. Trailer is being towed as level as possible with tow vehicle (at all times).
5. Trailer cargo does not exceed maximum weight limits (GVWR, GAWR, GCWR). Refer to trailer weights.

If a tire warranty adjustment is required, the trailer owner should contact the nearest authorized Fleetwood folding trailer dealer. In the event there is no local dealer, the customer should follow the directions set forth in the tire warranty card packaged in each folding trailer. A Fleetwood folding trailer dealer MAY be able to assist you in handling warranty adjustments.

**NOTE:** Not all Fleetwood folding trailers are capable of accepting different size tires. Prior to making any tire size changes, consult your dealer for tire size adaptability.

## **WHAT TO DO IF A FLAT TIRE OCCURS**

In case of sudden tire failure:

- *Avoid heavy brake application*
- *Gradually decrease speed*
- *Hold the steering wheel firmly and move slowly to a safe place off the road*
- *Park on a firm, level spot*
- *Turn off the ignition*
- *Turn on a hazard warning flasher system*

Even with good tire maintenance and normal driving, you may experience a flat tire. Summon professional help through your auto club road service, or a local tire service facility.

## **▲ WARNING**

To avoid personal injury and/or property damage if a blowout or other tire damage occurs, obtain expert tire service help. Do not attempt to change the tire yourself. Do not reinflate a tire that has been flat or is seriously low on air. Have the tire removed from the wheel and checked for damage. Never add air to tires unless an accurate pressure gauge is used.

## **▲ CAUTION**

Recheck lug nut torque before each trip, after each wheel removal, and thereafter at 10, 25, and 50 mile intervals. Re-torque at every 1,500 miles thereafter using the Wheel Torque Requirement chart found on page 53.

## **▲ CAUTION**

Under no circumstances should the weight of the trailer be lifted by a frame cross-member or the axle beam. Weight should only be lifted using the main frame bar.

## WHEEL TORQUE REQUIREMENTS

Wheel Size <u>Steel</u>	Torque Sequence 1 <sup>st</sup> Stage	Torque Sequence 2 <sup>nd</sup> Stage	Torque Sequence 3 <sup>rd</sup> Stage
10"	20 - 25 lbs.	35 - 40 lbs.	75 lbs.
12"	20 - 25 lbs.	35 - 40 lbs.	75 lbs.
13"	20 - 25 lbs.	35 - 40 lbs.	75 lbs.
14"	20 - 25 lbs.	50 - 60 lbs.	90 lbs.
Wheel Size <u>Aluminum</u>			
13"	20 - 25 lbs.	35 - 40 lbs.	75 lbs.
14"	20 - 25 lbs.	35 - 40 lbs.	75 lbs.
15"	20 - 25 lbs.	50 - 60 lbs.	90 lbs.

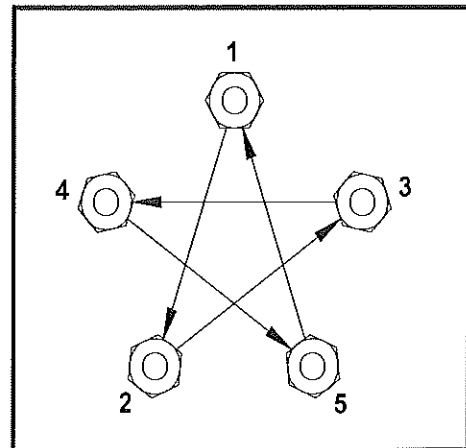

**Torque Chart**

## BALL HITCH AND COUPLER

All trailer models are equipped with a 2" ball coupler.  
(Maximum vertical load 500 lbs.)

Maintain a coat of light grease on the ball hitch of your vehicle. This will induce longer ball hitch life and towing ease. The coupler should be adjusted, when required, to maintain the coupler/ball tightness. With the coupler attached to the ball and the coupler release handle down in the locked position, adjust the lock nut (on the underside of the coupler) to compress spring to within 1/32" of solid. Make a visual inspection of the safety chains for damaged or corroded links; repair or replace as required. Ensure the ball hitch is securely attached to the tow vehicle and the hitch ball head is securely tightened.

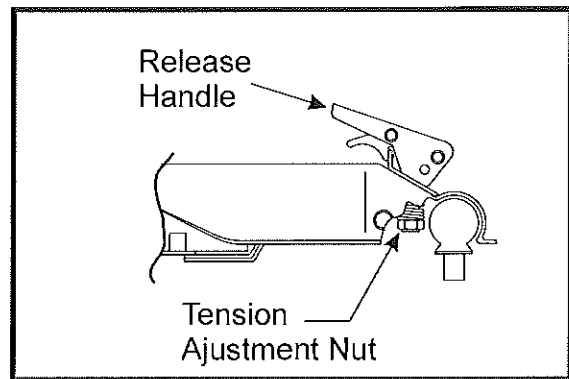

**Coupler**

## LUBRICATING/ADJUSTING WHEEL BEARINGS

**IMPORTANT:** Wheel bearings should be checked before the initial camping trip and then every twelve months or 12,000 miles, and at the beginning of each camping season.

Re-lubrication of wheel bearings is the most important service performed to the running gear. The two most important phases of this operation are cleanliness and proper adjustment. Before disassembly of the hub, check wheel play and freedom of rotation. Extreme or excess play indicates a too-loose adjustment or a defective bearing. Too much drag in rotation of the hub could indicate tightness in bearing adjustment or a brake being adjusted too tight. To begin disassembly, remove the wheel. Remove the dust cap by carefully prying around the flange of the cap. Next, remove the cotter pin and spindle nut. Jiggle the hub slightly to loosen the outer bearing. Usually the outer bearing will loosen up enough to be removed by hand.

Pull the entire hub which contains the inner bearing and grease seal. Remove the inner bearing by using a seal puller to remove the inner grease seal. Be sure not to damage the bearing case while removing the seal. Wipe all dirt and grease from the inside of the hub and the spindle.

Used bearings must be cleaned prior to lubrication. Various solvents are effective for degreasing. Successful processes employ kerosene, distillates, and chlorinated hydro-carbons. The solvent action of kerosene is limited, but it has the advantage of leaving a rust-inhibitive film on the bearing. After cleaning, bearings should be allowed to

drain free of solvent which might dilute lubricants. It is not recommended to reuse grease seals once removed. New grease seals should be installed when re-packing wheel bearings.

### **WARNING**

**Do not use above-described cleaning solvents near or around open flames as fire or explosion could occur resulting in serious bodily injury.**

Carefully inspect races and bearings for pitting, scratches, excessive wear, or other damage. Do not replace a bearing unless you also replace its mating race cup.

If at all possible, use a bearing packer to re-pack the roller cones. Using a high temperature wheel bearing grease (Type NLGI#2), the bearings can be lubricated by hand if the grease is pressed into and around each and every roller cone. Additional grease within the hub is not required. Install the inner bearing in the hub and replace grease seal by tapping gently with a wooden block, making sure the seal is installed as it was before disassembly. Replace hub on spindle, taking care not to damage threads or grease seal. Replace outer bearing and spindle nut. Slowly rotate the hub in one direction or the other while tightening the spindle nut (maximum 50 foot-pounds torque) or until there is a slight bind to be sure that all bearing surfaces are in contact. At this point the adjusting nut is backed off 1/6 to 1/4 turn or to the nearest locking hole or castellation. This will allow the wheel to rotate freely without excessive end play. By pushing inward and pulling outward on the hub several times a person should feel a very slight end play. If the bearings are too tight or too loose, they will fail prematurely. Install new cotter pin, bend to locked position, and drive on grease cap. Damage to the grease cap could cause the cap to disengage while traveling.

## **LIFT SYSTEM**

Never crank the trailer top assembly up with weight on the roof except for a dealer-installed air conditioning unit. Additional weight placed on the top assembly while the unit is being cranked up can result in an unnecessary strain on the lift system causing cables to be stretched and the loss of proper roof height adjustment. Never raise or lower the roof with the stabilizer jacks set. This action can cause a bind on the trailer frame resulting in excessive pressure being placed on the four lift assemblies and pulleys. (Maximum combined weight of roof-mounted accessories is 150 pounds with the top open.)

## **MAINTENANCE**

The maintenance that will be necessary to perform to your lift system is an annual lubrication of the pulleys contained within the lift system and annual lift height adjustment. Lubrication should be only a silicone spray and used very sparingly.

**NOTE:** Excessive lubrication on the pulleys or lubrication on the outer face of the lift arms can result in unsightly stains or loss of water repellency to the tent enclosure.

## **TOP ADJUSTMENT**

Height adjustment, if necessary, can be performed at each main cable adjustable pulley bracket. One bracket is located in each corner of the main frame tube area.

Crank top to approximately 12" high. Extend front and rear bed assemblies approximately one foot past body rails. Lower top down on extended beds until crank stops to relax cables. Remove pulley pin and relocate pulley to an alternate hole position. (Each adjustment hole should add about 1 1/2" lift height to that particular corner. Do not over-

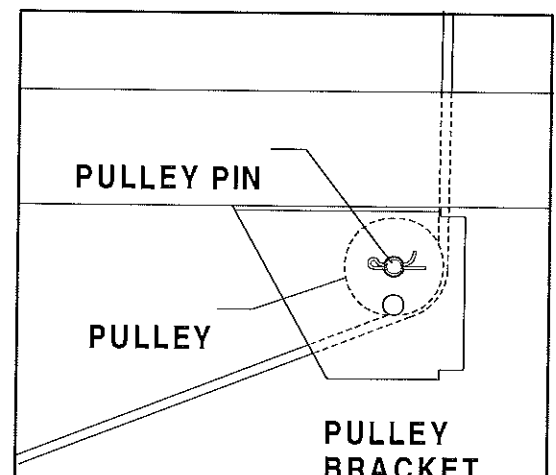

adjust or tenting and weather seals may be damaged or pull out of the retaining track.) Raise top and return beds to travel position.

**NOTE:** Top height adjustment is considered routine maintenance and is not covered under normal trailer limited warranty.

**NOTE:** Fine adjustments can only be performed at the main drive train area. This adjustment should be performed by an authorized Fleetwood folding trailer dealer.

**IMPORTANT:** We emphasize that any customer repairs to the lift system should only be done as a temporary measure. Your dealer should be consulted prior to performing any lift system service to prevent inadvertent damage to the system.

## TENT ENCLOSURE

---

### CLEANING

The tent enclosure should be cleaned as needed before substances such as dirt are allowed to accumulate and become embedded in the fabric. The fabric can be cleaned without being removed from the trailer. Simply brush off any loose dirt. Hose down and clean with a mild solution of Dreft® laundry detergent or Woolite® fabric cleaner in water. Rinse thoroughly to remove soap. Dilute as follows:

- Dreft® - Dissolve two tablespoons in one cup of water (no more than 100°F) for spot cleaning.
- Dreft® - Dissolve 3/4 cup in washing machine (no more than 100°F) to wash entire tent section.
- Woolite® - Dissolve one capful per gallon of water (use cold water only) for spot cleaning.
- Woolite® - Dissolve 1/4 cup in washing machine (cold water only) to wash entire tent section.

#### CAUTION

Air dry only after washing tenting. Do not use commercial drying machines. Do not allow other cleaners used for tops, body panels, etc., to come in contact with the Sunbrella 302 tenting.

If the fabric indicates slight water leakage as a result of residual soap, repeat rinsing. A second alternative is to treat the fabric with a water repellent such as 303 High Tech Fabric Guard. Never close the trailer with a water repellent treatment still wet. The tent enclosure could become permanently damaged.

**IMPORTANT:** The tent fabric should always be dry when closing or storing the trailer. If the trailer must be closed with the tent fabric wet, for example breaking camp during rain, it is of utmost importance to open the trailer as soon as possible to allow the tent fabric to dry. This will prevent mildew growth which can occur on dirt or other foreign substances not removed from the tent fabric.

**NOTE:** All washing and maintenance of tent enclosure material is the consumer's responsibility and is not covered under the normal trailer limited warranty.

### CONDENSATION PREVENTIVE MAINTENANCE

The relatively small volume and compact construction of a modern recreational vehicle mean that the normal living activities of even a few occupants will lead to rapid moisture saturation of the air contained in the trailer and the appearance of visible moisture, especially in cold weather. The air inside a recreational vehicle can contain a surprisingly large amount of water vapor. Estimates indicate that a family of four can vaporize up to three gallons of water daily through breathing, cooking, bathing, and washing. Unless this water vapor is carried outside by ventilation, it will condense on the inside of the tent enclosure as moisture. If you know the signs of excessive moisture and condensation, you can minimize their effects during cold weather by the following:

1. Ventilate with outside air. Partially open one or more windows to provide controlled circulation of outside air into the interior. While this ventilation will increase furnace heating load, it will greatly reduce or eliminate water condensation. Even when it is raining or snowing, ventilation air from outside will be far drier than interior air and will effectively reduce condensation.
2. Provide more ventilation while cooking is being done inside the camper.
3. Ensure adequate ventilation in areas where condensation problems are experienced.
4. The use of an electric circulating fan or a small dehumidifier inside the camper will noticeably reduce condensation.

## **INFORMATION ABOUT MOLD AND IMPORTANT NOTICES**

Mold is a fungus that occurs naturally in the environment and serves necessary functions, including aiding in the decomposition of plant and other organic material. Mold spreads by means of microscopic spores borne on the wind and is found everywhere life can be supported. Mold has existed for millions of years, and human beings have coexisted despite their exposure to mold and mold spores.

If the proper conditions are present, mold can and will grow in your trailer. Most owners are familiar with mold growth in the form of bread and cheese and on bathroom tile. In order to grow, mold requires a food source. These food sources might be supplied by items found in the trailer, such as fabric, carpet, wallpaper, or building materials (i.e., drywall, wood, and insulation). Also, most mold growth requires a temperate climate. The best growth occurs at temperatures between 40°F and 100°F. Most importantly, mold growth requires moisture, and moisture is the only growth factor that can be controlled. By minimizing interior sources of moisture, an owner can reduce or prevent mold growth. However, if optimal growth conditions persist, mold can develop within 24 to 48 hours.

Moisture in the trailer can stem from a variety of sources such as spills, leaks, overflows, condensation, and human activity such as showering or cooking. Good maintenance practices are essential in the effort to prevent or reduce mold growth.

### **What Can the Owner Do?**

The owner can take positive steps to reduce the occurrence of mold growth in the trailer and thereby minimize any possible adverse effects that may be caused by mold. These steps may include, but are not limited to, the following:

- Before bringing items into the trailer, check for signs of mold. Potted plants (roots and soil), furnishings, or stored clothing and bedding materials may also contain mold spores.
- Regular vacuuming and cleaning will help reduce levels of settled mold spores. Additionally, detergent solutions and most tile cleaners are effective in controlling mold growth on surfaces.
- Keep the humidity in the trailer below 40%. Ventilate kitchens and bathrooms by opening windows, using exhaust fans, or running the air conditioning to remove excess moisture in the air and to facilitate evaporation of water from wet surfaces. In general, windows or doors throughout the trailer should be opened periodically to assist in the ventilation process.
- Promptly clean up spills, condensation, and other sources of moisture. Thoroughly dry any wet surfaces or material. Do not let water pool or stand in your trailer. Promptly replace any materials that cannot be thoroughly dried, such as drywall or insulation.
- Inspect for leaks on a regular basis. Look for discolorations or wet spots. Repair any leaks promptly. Inspect condensation pans (refrigeration and air conditioners) for mold growth. Take notice of musty odors and any visible signs of mold growth.

Other actions you can take to prevent moisture issues include the following:

- Do NOT use unvented propane, kerosene, or other unvented combustion heaters.
- Do NOT cover or close off the floor registers.
- Use exhaust fans in kitchen and bathrooms to remove excess moisture.
- Clean the bathroom with mold-killing products.
- Do not carpet bathrooms.

For more information about mold, and what you can do to reduce moisture and mold growth in your trailer, please refer to the following web sites and literature:

1. U. S. Environmental Protection Agency. Mold Remediation in Schools and Commercial Buildings. 2001.  
<http://www.epa.gov/iaq/molds/moldremediation.html>
2. U. S. Environmental Protection Agency. A Brief Guide to Mold, Moisture, and Your Home. 2002.  
<http://www.epa.gov/iaq/molds/moldguide.html>

## VINYL BED END COVERS

The exterior vinyl over the bed areas can be cleaned as needed by using cool water and a soft bristle brush or cloth. Rinse thoroughly with cool water and allow to dry. When necessary, automobile convertible top cleaners can be used to remove stains.

**IMPORTANT:** Care should be taken not to allow the vinyl cleaner to come in contact with the tent material or tent leakage may result. Follow the manufacturer's instructions carefully for use of such cleaners or damage to the vinyl surface could occur. Direct contact of insect repellents, hair sprays, and/or suntan lotion/oils on the tent surfaces will cause a breakdown of the water repellency of the fabric. Care should also be used around drapes and privacy curtains. Some cleaners will stain or fade the fabric.

The interior cloth coating over the bed areas can be cleaned using clean water and mild soap such as Dreft®. Dissolve two tablespoons in one cup of water (less than 100° F) for spot cleaning. Rinse with clean water or a damp cloth.

The zippers on your tent can be lubricated by using a paraffin wax. The use of paraffin on the zippers will enhance their ease of operation around the tent sections and windows.

## MATTRESS CARE

For cleaning dirt and stains from the mattress fabric, follow the outlined procedures below:

1. Remove loose dirt with a soft brush or compressed air.
2. Cleaning solution: 5% Dawn dish washing detergent and 95% water.
3. Wet area using spray bottle set to medium spray.
4. Spray directly on spot but do not saturate fabric.
5. Immediately blot or wipe dry with handi-wipe or soft sponge. Use of foam rubber not recommended.

# ROOF-MOUNTED ACCESSORIES

Before storage maintenance should be performed to all roof-mounted accessories. Check all sealant of accessory attachment points to roof assembly. Cracks or voids in sealant can lead to water damage to roof and interior trailer components.

## ⚠ CAUTION

Do not exceed 150 pounds of roof-mounted cargo/weight while raising and lowering the top assembly. Exceeding this weight limit could damage the lift system.

## ROOF-MOUNTED AIR CONDITIONERS

An optional roof-mounted air conditioner can operate only when the trailer is connected to 110 VAC power from either a park supply or a generator. A separate 20 amp receptacle is provided inside the trailer for the air conditioner to be plugged into. Routine maintenance for a roof-mounted air conditioner should include inspecting the ceiling assembly attachment bolts after each trip to ensure the bolts have not loosened or backed-out due to road vibration. For further maintenance on your air conditioner, follow the manufacturer's recommendations as outlined in the air conditioner owner's manual.

## ELECTRICAL

When the campsite provides an electrical system: Plug the power cord into the campsite-provided 110 volt outlet (30 amp service U.S./CSA AC current).

## ⚠ WARNING

The electrical system is rated for a maximum (30 amp USA/CSA) AC current. Be sure not to exceed this rating. Excessive amperage draw could cause electrical system problems. Be sure any outlet the trailer is plugged into is grounded and has the correct polarity.

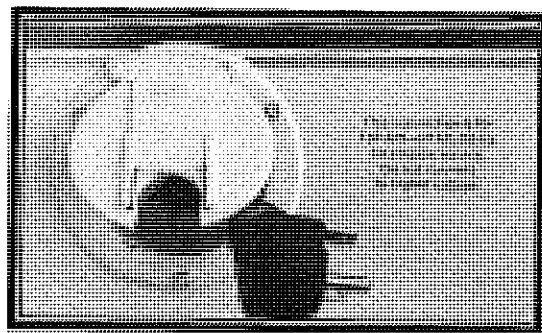

*30 Amp Power Cord*

## CONVERTER

The converter changes the 110 volt AC park supply to +12 VDC for operation of the interior +12 volt lights and certain +12 volt appliances (i.e., furnace). During cold weather start-up, 10°F or less (outside ambient air temperature), a +12 volt output delay will occur. Allow the converter to warm-up once plugged into the 110 volt park supply for three to five minutes before applying a load to any +12 volt circuit. **The +12 VDC is a filtered voltage and may be suitable for use with appliances such as radios or television monitors.** The receptacles inside the trailer carry the 110 volt current for operation of 110 volt appliances and the like.

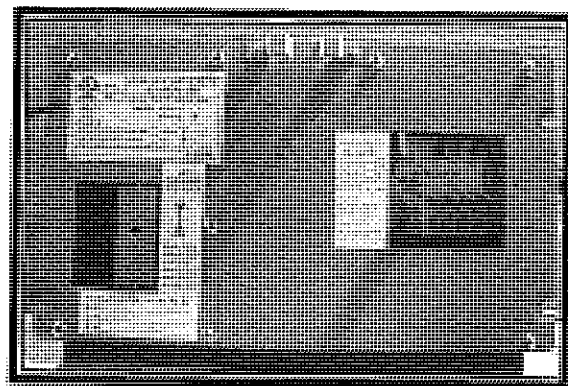

*Trailer Converter*

When the converter is "unplugged" from the 110 volt park supply, the interior electrical lights and appliances must be serviced by an external +12 volt battery for the electrical supply. This external battery could be the tow vehicle battery or an auxiliary battery mounted on the tongue of the trailer.

All converters will switch from AC to DC automatically and will not have a manual changeover switch.

If the converter is not plugged into a 110 VAC source, the 110 VAC outlets within the trailer will not operate.

All converters contain a battery charge unit within the converter. Therefore, it is recommended during long periods of non-use that the trailer be plugged into a 110 VAC source over night to maintain the battery charge. Always follow the converter manufacturer's recommendations. Do not accidentally switch battery polarity at the terminals.

If the converter output is overloaded, the converter has a built-in temperature protection circuit which will shut down the converter. In the event that a short develops in the +12 volt electrical output system of the trailer, the converter will shut down indicating that a short has been detected. Immediately disconnect the last item and wait for the converter to cool. Once the converter cools (approximately one minute) the converter will then reset and supply +12 volt output. A fuse may also fail if overloaded. If the converter continues to shut-down, the overload condition must be corrected before normal operation of the converter will resume. Contact a qualified R. V. or electrical technician for assistance.

**NOTE:** For additional information on the converter contained within your trailer, refer to the converter operation manual in your trailer literature package.

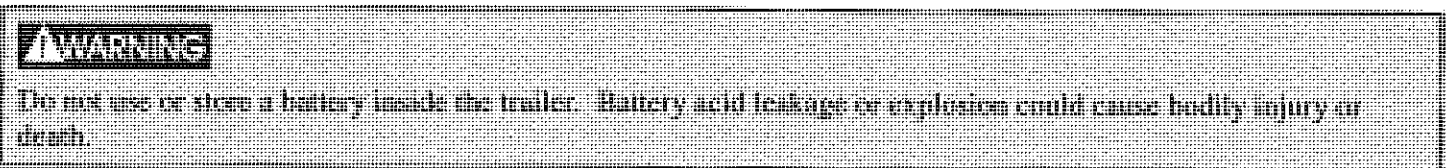

On the tongue of the trailer are two +12 volt DC wiring harness connectors. The main harness is a male connector which connects to the +12 volt tow vehicle plug for the operation of running lights, brake lights, and so forth. Each model also has a two-prong female connector which is for the auxiliary trailer battery operation of the +12 volt interior lighting system and optional equipment on battery. In order to use the two-prong receptacle, it is necessary to purchase the +12 volt auto extension cord or battery mount kit from your dealer. The +12 volt auto extension cord may be plugged into the tow vehicle cigarette lighter to provide +12 volt power to the interior of your camper. The battery mount kit contains a +12 volt wire harness with terminal connectors to attach to the auxiliary trailer battery mounted to the tongue.

**IMPORTANT:** All propane leak detectors must be connected to a constant +12 volt power source at all times to operate. During periods of non use, the tow vehicle or auxiliary trailer battery should be disconnected. Otherwise, the propane leak detector will drain the battery.

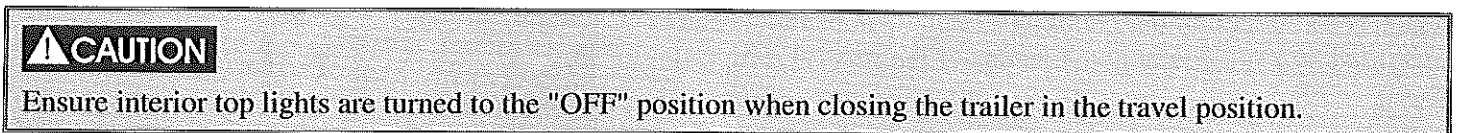

The electrical system of your folding trailer is broken down into two separate and distinct functions: the +12 volt direct current and 110 volt alternating current.

## +12 VOLT ELECTRICAL CIRCUIT

The +12 volt DC electrical circuit is dependent on the tow vehicle's battery or an auxiliary trailer mounted battery. Frequent and regular checks of the battery should be made to assure electrical system stability. To obtain an accurate battery rating, all +12 volt electrical appliances such as the furnace, water pump, etc., must be turned off prior to checking the battery. We suggest the following checks:

1. Battery terminals and posts free from corrosion.
2. Battery terminals securely fastened to the battery posts.



3. Battery water level.
4. Battery voltage at the level specified by the battery manufacturer.
5. Recharging battery over night once a month. (Ensure adequate ventilation.)

Before each trip, make an operational check of all +12 volt DC electrical functions of the trailer: turn, stop, side marker, and taillights. If a bulb does not light, remove the lens cover from over the bulb not functioning. Most often, bulb replacement will cure the malfunction; however, should the malfunction persist, contact your authorized Fleetwood folding trailer dealer or a qualified electrician.

All model trailers are equipped with a **+12 volt DC in-line kill switch**. This switch is located on the lower galley top. When the galley is raised to the upright position, the switch will activate thus allowing power to be supplied to the interior top lights. On some models, the kill switch is located on the rear/front wall. The bed must be completely set-up to activate the kill switch. Shower equipped trailers have an ON/OFF switch to turn the +12 volt electric pump on and off. Tip-out galleys and glide-out dinette areas have an auxiliary +12 volt recessed plug installed on the interior of the top for attachment of additional optional +12 volt light fixtures. Some models will have an exterior porch light with an auxiliary +12 volt DC jack. This jack is to be used with the optional +12 volt DC reading light. The reading light can then be stretched out to illuminate the enclosed screen room.

**HINT:** Pre-cool the refrigerator on the 110 volt refrigerator setting while packing. Prior to leaving, switch the selector switch to the +12 volt DC setting. Following this hint will allow the +12 volt trailer battery to sparingly operate the refrigerator thermostat to maintain the cabin temperature inside the refrigerator and keep the contents from spoiling or thawing.

The +12 volt auxiliary battery should be used sparingly to avoid severe battery drainage. If the battery becomes too severely drained, an overload charging condition could occur within the converter. This can cause the converter to overheat and shut down. This will occur off and on until the battery becomes charged enough to allow sufficient amperage to run the lights, furnace, etc.

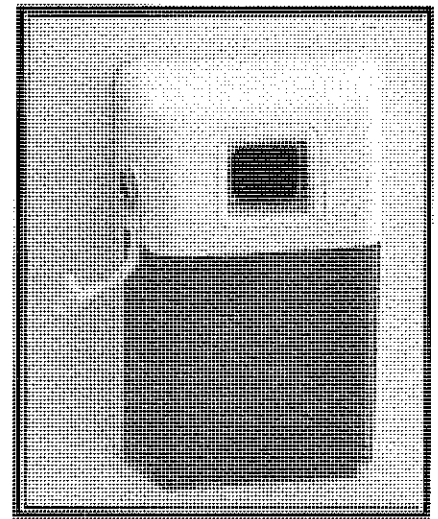

**Porch Light**

## 110 VOLT AC POWER CIRCUIT

The 110 volt AC power cord can be plugged into a park supply power source for the operation of interior and exterior receptacles only. Two AC circuits are available, a 15 amp circuit which incorporates a Ground Fault Circuit Interrupter (G.F.C.I.) receptacle plus one or two regular outlets, and a 20 amp circuit which is for air conditioner hook-ups. All 20 amp circuits can be identified by a horizontal notch on one of the vertical receptacle legs.

**NOTE:** Certain models also have a 20 amp G.F.C.I. receptacle where applicable. Refrigerator compartment receptacles should not have any other appliances plugged into them.

**All model trailers** are equipped with a 110 volt AC exterior outlet for your convenience. This outlet is wired in series with a G.F.C.I. This device is intended to protect you against the hazards of line to ground electric faults and electrical leakage shocks. Materials used to insulate appliances and devices can deteriorate over time or develop cracks or weak spots that could allow electric current to "leak" through the insulation. Should a circuit or appliance develop a potential shock hazard of this type, the G.F.C.I. device is

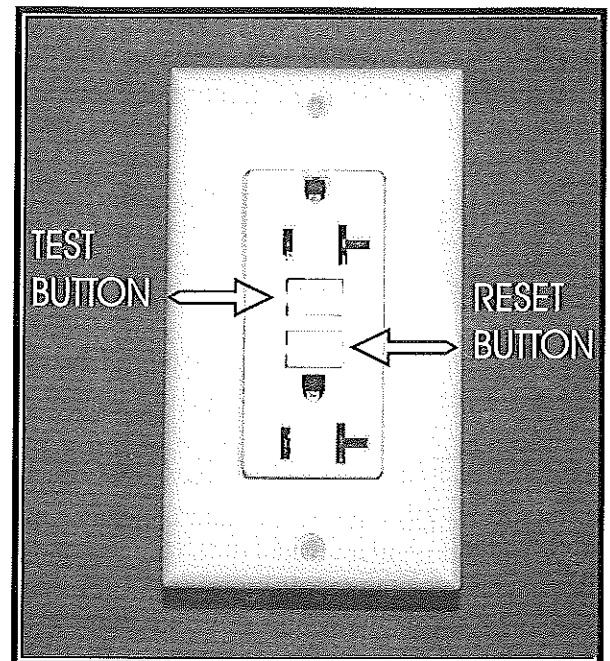

**Typical G.F.C.I. Receptacle**

designed to disconnect the outlet (and other outlets on the same circuit), limiting your exposure time to the shock hazard caused by current leakage to ground.

**The G.F.C.I. device does not prevent electric shock, nor does it protect a person who comes into contact with both "hot" and neutral sides of the circuit. It does not protect against electrical circuit overloads. Test the G.F.C.I. at least once a month while operating on 110 volts AC. To test the G.F.C.I.:**

- \* Push the "TEST" button. The "RESET" button should pop out, indicating that the protected circuit has been disconnected.
- \* **If the "RESET" button does not pop out when the test button is pushed, a loss of ground fault protection is indicated. DO NOT use the outlet or other outlets on the same circuit. Have the trailer electrical system checked by an authorized Fleetwood Folding Trailer Dealer or by a Qualified Electrician. DO NOT use the system until the problem has been corrected.**
- \* To restore power push the "RESET" button.

**NOTE:** If a 110 volt outlet doesn't work, check the G.F.C.I. or circuit breaker (15/20 amp). Reset it if necessary. If the G.F.C.I. continues to trip, have the trailer electrical system checked at an authorized Fleetwood Folding Trailer Dealer or by a qualified electrician.

**NOTE:** Due to the variety of interior floor plans, the G.F.C.I. receptacle may be placed in different locations from one model to another.

## +12 VOLT EXTERIOR WIRING COLOR CODES

GREEN - TAIL, TAG, MARKER  
WHITE - GROUND  
RED - LEFT TURN AND STOP  
BROWN - RIGHT TURN AND STOP  
BLUE - ELECTRIC BRAKES  
BLACK - AUX. 12 VOLT  
BLACK/RED TRACER - AUX. 12 VOLT

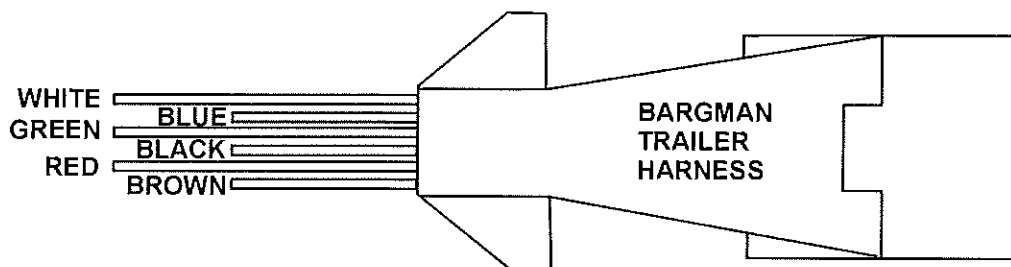

# MAINTENANCE CHART

NOTE: MAKE NECESSARY REPAIRS AS USE AND PERFORMANCE REQUIRES.

NOTE: SERVICES ARE TO BE PERFORMED AS NOTED IN THE HIGHLIGHTED AREAS.

<b>BEFORE EACH TRIP</b>	<b>EVERY THREE MONTHS</b>
Inspect safety chains	Clean and lubricate breakaway switch pin
Inspect trailer/tow vehicle wiring connections	Lubricate bed rollers (3 in 1 oil lubricant)
Inspect propane leak detector	<b>ANNUALLY OR BEFORE STORAGE</b>
Inspect hitch components	Inspect and reseal all exterior roof and body sealants
Test break-away switch	Check all roof mounted accessories
Inspect tires for wear	Lubricate lift arm pulleys and lift height adjustment
Check tire pressure	Winterize water system and drains
Check wheel lug nut torque	Lubricate glide-out compartment track and rollers.
Check exterior lighting	Disconnect battery (where applicable)
Inspect propane components	Ensure tenting fabric is dry
Inspect A/C ceiling assembly bolt tightness	Remove and clean shower curtains
Lubricate crank-down stabilizers	Clean fresh water hoses and storage tanks
Inspect and clean battery, cables and terminals	<b>ANNUALLY OR AFTER STORAGE</b>
Check fire extinguisher	Inspect all hot/cold drain plumbing components
Wash exterior (trailer closed)	Inspect brakes/Adjust (200 miles initially; 3000 miles thereafter) X
<b>MONTHLY</b>	Sanitize fresh water tanks system/cassette potty or tanks
Inspect and clean water pump filter	Lubricate coupler and latch
Re-charge battery (where applicable)	Complete propane pressure and system check X
Test 110 volt G.F.C.I. circuits	Re-pack wheel bearings (every 12 months or 12,000 miles) X
<b>EVERY TWO MONTHS</b>	<b>AS NEEDED</b>
Inspect exterior roof sealants	Clean tenting
	Clean interior (cushions, covers, bed vinyl, mattresses)
	Lubricate door latches and locks

"X" Indicates items that should be performed by qualified personnel with appropriate equipment.

STANDARD CARE ITEMS AND RECOMMENDED CLEANING AGENTS

Stove and sinks	Appropriate household cleaners
Counter tops	Warm soapy water
Bathtub	Non-abrasive household cleaner
Cooler/refrigerator	Mild soap and water
Drapes and valances	Hand wash with lukewarm water
Mattress covers	5% Dawn® dish washing liquid and 95% water; immediately blot or wipe dry
Cushion/backrest covers	Foam type cleaners and vacuum
Table top	Damp cloth
Vinyl windows	Warm water and mild detergents
Vinyl floor covering *	Water and mild soap
Body panels	Mild soapy water
Top assemblies	Wash with non-abrasive household liquid detergents
Sunbrella 302 tenting	Woolite®, 1 capful per gallon of water (use soft sponge)

\*To keep your vinyl floor covering looking new, it is advisable to place a throw rug or carpet on the floor covering directly underneath the area in which the galley will rest during transit.

**\*FIBERGLASS TOP ASSEMBLY**

It is important to note that any finish will deteriorate with time. Dulling and fading can be increased by exposure to extreme sunlight, air pollutants, and excessive moisture. Surface weathering of fiberglass does not change the strength of the fiberglass. Regular washing of exterior surfaces is the best insurance against surface deterioration such as fading, yellowing, or chalking.

## WINTER/OFF-SEASON STORAGE

When storing your Fleetwood Folding Trailer for extended periods of time, the following steps should be observed:

1. Clean thoroughly and remove all perishables and food. Use a damp cloth and baking soda to wipe out the refrigerator. Cooking appliances should be cleaned to remove dirt and grease.
2. Cover exterior appliance vents to prevent insects from entering.
3. Check the sealant around the roof and body seams. Ensure all doors and hatches are closed and water tight.
4. Winterize water system and turn off propane cylinder valve.
5. Angle trailer tongue end slightly downward to eliminate water, snow or ice build-up on top assembly. Snow load should be removed from the top assembly to prevent damage.
6. If trailer is equipped with roof mounted accessories, open every two months or sixty days to ensure all accessory seals are functioning.
7. DO NOT store trailer in tall grass, weeds or near wood piles.
8. Disconnect auxiliary trailer +12 volt tongue-mounted battery or periodically recharge once a month.

### **WARNING**

Trailers stored in enclosed garages or buildings must be well ventilated. If not ventilated, then remove the propane cylinders and +12 volt battery and store them in a cool, dry, and well ventilated place, preferably outside.

# CHANGE OF OWNERSHIP NOTIFICATION

---

## CHANGE OF OWNERSHIP NOTIFICATION

If you are the second or subsequent owner of this folding trailer, it is important that you notify Fleetwood Folding Trailers of your name, address, and the Serial Number of your trailer. This information is vital for Fleetwood Folding Trailers to maintain up-to-date records of current ownership. Please complete the form below, clip it, and mail it to:

**Fleetwood Folding Trailers, Inc.**  
258 Beacon Street, P.O. Box 111  
Somerset, Pennsylvania 15501

### MODEL INFORMATION

Year \_\_\_\_\_ M

Trailer Serial No. \_\_\_\_\_

**NEW OWNER INFORMATION** Purchase Date \_\_\_\_\_

Name \_\_\_\_\_

Address \_\_\_\_\_

City \_\_\_\_\_ State \_\_\_\_\_ Zip \_\_\_\_\_

Name of Previous Owner \_\_\_\_\_







