

1993
LOWNERS' MAINTUAI

DESTINY series

cedar
royale
roanoke
rio grande



BY FLEETWOOD



FLEETWOOD FOLDING TRAILERS, INC.
RD 2, P.O. Box 111
Somerset, Pennsylvania 15501
(814) 445-9661
(814) 445-6558 FAX

To Our Valued Customer:

It is our pleasure to welcome you to our Fleetwood owner's family. Your new Fleetwood folding trailer was designed by a team of specialists who are dedicated to making your camping experience one of the most memorable times of your life!

For over 40 years Fleetwood, as the world's largest manufacturer of R.V.s, has built a solid reputation of providing quality products with features that offer safety, comfort, convenience, and value. Today, as well as in the future, no matter where you travel you will find that Fleetwood will be there to serve your needs.

You will be glad you chose a Fleetwood folding trailer by Fleetwood - The Number One Brand Folding Trailer in the World! We thank you for the confidence you have placed in our company and our products, and we will do everything possible to continue to earn your confidence and your loyalty.

Our best wishes for many years of safe and fulfilled camping pleasure and fond memories that will last a lifetime.

Patrick O. Scanlon
Division General Manager
Folding Trailer Division

Larry Marsh
Director of Sales and Marketing
Folding Trailer Division

WELCOME . . .

to the wonderful world of carefree living you'll be enjoying in your new Fleetwood trailer. Like all Fleetwood products, your Fleetwood trailer by Fleetwood is the best in its class loaded with all the quality and craftsmanship that have made Fleetwood famous.

This manual shows you in easy-to-read language how to get the most out of your camper the easy way, plus tips on maintenance that will keep your camper rolling through the years - virtually trouble-free. A quick look at the "Table of Contents" will show you what we mean.

So, before you take off, take a little time to read the sections on Pre-Trip Preparations, Set-Up Instructions, Take-Down Instructions, Loading, and Maintenance. It's easy reading and it really does show you how to get the most out of your camper - the easy way. Have a good trip - after all, you're traveling first class in a Fleetwood trailer!

TABLE OF CONTENTS

INTRODUCTION	1
IMPORTANT CONSUMER INFORMATION	2
PRE-TRIP PREPARATIONS	3
HINTS AND TIPS	4-6
SET-UP INSTRUCTIONS	7-24
Getting Started	7-9
Stabilizer Jacks	9-10
Bed Set-up	10-12
Tent Enclosure Set-up	12-14
Screen Door Set-up	14-16
Hinged Galley/Stove Cabinet Set-up	16-17
Inside/Outside Stove Set-up	18-21
Dinette Set-up	21
Bed Bow Support Set-up	21-22
Electrical and Water Hook-ups	22-24
TAKE-DOWN INSTRUCTIONS	25-28
SYSTEMS AND SPECIAL FEATURES	29-43
Trailer L.P. Gas System	29-32
Trailer Electrical System	32-33
Water System	34-35
Tracking System	35-39
Lift System	40-41
Tent Enclosure	41-43
Miscellaneous Standard Features	43
MAINTENANCE	44-45
SPECIFICATIONS	46
WARRANTY	47-49
DEFECT REPORTING	50

INTRODUCTION

This manual contains important information regarding the safe operation and maintenance of your Fleetwood folding trailer. We urge you to read it carefully, understand all aspects of your trailer, and follow the recommendations to obtain the most trouble-free use of your recreational vehicle.

In this manual, statements preceded by the following words are of special significance:

"WARNING" means that there is a high possibility of serious personal injury to yourself and others if the warning is not complied with.

"CAUTION" means that there is the possibility of personal injury to yourself or others.

"IMPORTANT" means that there is a possibility of damage to the trailer if instructions are not followed.

"NOTE" indicates points of particular interest for more efficient and convenient operation.

We recommend that you take particular notice of these items when reading this manual.

NOTE:

The words "shall" or "must" indicate a requirement which is essential to satisfactory and safe product performance.

The words "should" or "may" indicate a recommendation or advice which is not essential and not required but which may be useful or helpful.

Please remember that when service is required, your Fleetwood folding trailer dealer knows your vehicle best. Consult him for any assistance you may require.

NOTE:

Federal law requires you to register the serial numbers of your trailer tires. For your protection, the original equipment tire serial numbers must be recorded on the warranty registration form received with your trailer. Your dealer will supply you with the necessary forms to register any additional tires (spares) you may purchase. Tire registration is not a guarantee or warranty for either the tires or the trailer.

NOTE:

Photographs and illustrations in this manual are representative of function and may or may not be specific in their depiction of actual equipment, fabrics, interior or exterior decor or design, options as installed on or in your trailer.

NOTE:

This product is designed for recreational use and short-term occupancy only. It is not designed nor intended to be used as permanent housing.

IMPORTANT CONSUMER INFORMATION

Installation and Instructions for Appliances. Operating instructions are provided for each appliance, including air conditioning appliances (other than automotive type).

This recreational vehicle is equipped with listed fuel utilization equipment and an owner's manual which contains the following information:

WARNING: L.P. gas containers shall not be placed or stored inside the vehicle. L.P. gas containers are equipped with safety devices which relieve excessive pressure by discharging gas to the atmosphere.

WARNING: IT IS NOT SAFE TO USE COOKING APPLIANCES FOR COMFORT HEATING.

Cooking appliances need fresh air for safe operation. Before operation, open a window.

This warning label has been located in the cooking area to remind you to provide an adequate supply of fresh air for combustion. Unlike homes, the amount of oxygen supply is limited due to the size of the recreational vehicle, and proper ventilation when using the cooking appliance(s) will avoid dangers of asphyxiation. It is especially important that cooking appliances not be used for comfort heating as the danger of asphyxiation is greater when the appliance is used for long periods of time.

A warning label has been located near the L.P. gas container. This label reads:

DO NOT FILL CONTAINER(S) TO MORE THAN 80 PERCENT OF CAPACITY.

Overfilling the L.P. gas container can result in uncontrolled gas flow which can cause fire or explosion. A properly filled container will contain approximately 80 percent of its volume as liquid L.P. gas.

Do not use portable fuel-burning equipment including stoves inside the recreational vehicle. The use of this equipment inside the recreational vehicle may cause fires or asphyxiation.

Do not store L.P. gas containers, gasoline, or other flammable liquids inside the vehicle because a fire or explosion may result.

IF YOU SMELL GAS:

1. Extinguish any open flames, pilot lights, and all smoking materials.
2. Do not touch electrical wires.
3. Shut off the gas supply at the tank valve(s) or gas supply connection.
4. Open doors and other ventilating openings.
5. Leave the area until odor clears.
6. Have the gas system checked and leakage source corrected before using again.

L.P. gas regulators must always be installed with the diaphragm vent facing downward. Regulators that are not in compartments have been equipped with a protective cover. Make sure that regulator vent faces downward and that cover is kept in place to minimize vent blockage which could result in excessive gas pressure causing fire or explosion.

PRE-TRIP PREPARATIONS

Before you seek out those favorite recreational campsites with your new Fleetwood folding trailer, we suggest you first make these pre-trip preparations.

Read the information in this booklet very carefully. Please note that the text for the set-up and take-down instructions does not differentiate between models. When the text does not apply to your model, continue on to the next applicable step. Set up and take down the trailer per the instructions several times to familiarize yourself completely with the procedure.

Establish a tool kit for your trailer's maintenance needs and stow it in the trunk of your tow vehicle. The following items should be included:

1. Standard slot screwdriver
2. Standard phillips screwdriver
3. Hydraulic or scissor jack (1 1/2 ton)
4. 13/16" lug wrench
5. Stabilizer jack handle (furnished)
6. Crankshaft handle (furnished)
7. Two blocks of wood (approximately 2"x6"x10")
8. Four wheel chocks

Final preparations should include the proper loading (See **LOADING**) and physical check of the trailer before the trip.

The trailer should be loaded with these basic rules in mind:

1. Keep your trailer as light as possible. Reducing weight will increase gas mileage.
2. Distribute the weight as evenly as possible.
3. **Be certain that a minimum of 10% of the overall trailer weight is on the ball hitch of the tow vehicle. Less than 10% will result in a negative tongue weight causing whipping or swaying while towing.**
4. Water tanks do not need filling unless primitive camping is planned; fill water tanks at campground to reduce towing weight. Make your first trip close to home.

A physical check should also be made per this checklist. Be certain that:

1. Tires are inflated to the recommended pressure as indicated on the tire sidewall.
NOTE: The three main causes for early tire wear and/or premature tire failure are.
 1. Under inflation
 2. Over loading (cargo)
 3. Improper towing (see towing section)

Due to the relatively small tire sizes used on folding trailers always check the tire air pressure prior to each camping trip. Temperature changes can result in loss of tire air pressure. See Specification page for cargo capacities recommended.

2. Wheel lug nuts are properly torqued: 8" wheels, 70-80 ft lbs; 12" wheels, 80-90 ft lbs. Check torque before first trip. Retorque after first 25 miles. Retorque after first 75 miles. Retorque periodically thereafter and before each trip.
3. The tongue coupler is securely fastened to the ball hitch with safety pin in place.
4. The safety chains are attached (chains must crisscross) where applicable.
5. The electrical pigtail is connected.
6. All lights on the trailer are functioning properly.
7. The L.P. gas bottle valve is closed.
8. The cooler and other items are securely held in place.

We hope you read and follow these instructions and helpful hints very closely. If you do, you will receive the maximum benefit from your Fleetwood folding trailer.

HINTS AND TIPS

A. Hitch

When mounting a hitch on your tow vehicle, a minimum distance of 4" between the hitch ball and the tow vehicles bumper is recommended. (See Figure 1)

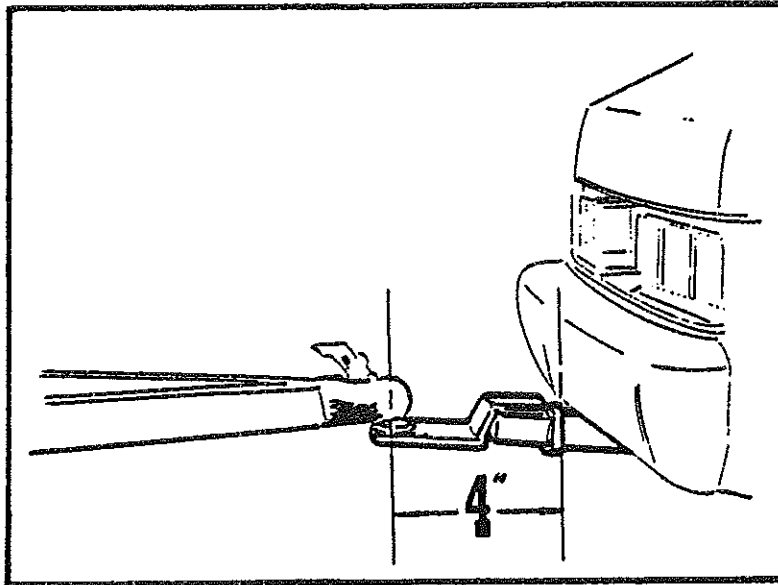
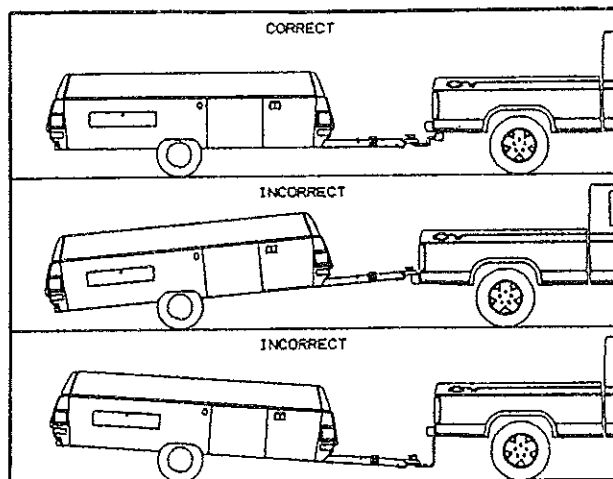

FIGURE 1

Any hitch with the coupler ball mounted closer than 4" may allow the frame to make contact with the bumper resulting in "A Frame" damage. (This is most frequently found to be true on step bumper applications.)

B. Towing

It's of utmost importance to keep the trailer as level as possible when hooked to the tow vehicle's hitch. Towing a trailer with the tongue inclined will cause premature tire wear. This is also found to be true if the tongue area is angled downward. See figure below for the correct method in which to tow a folding trailer.



Even if you've towed before, you'll want to get the feel of maneuvering any new outfit, so practice starts, stops, parking, braking, and turning. When driving around town, always check the traffic clearance before pulling out from the curb or shoulder into the main traffic flow. For turns, pull past your turn or intersection sufficiently before turning so as not to run into the curb or obstructions. The longer your trailer, the wider you must swing for clearance. Most new owners are surprised at how well Fleetwood trailers track and how little additional maneuvering space is required, but don't let this cause you to forget it's behind you.

During parking or backing, remember that the rear of the folding trailer moves opposite to the rear of the towing vehicle. Start by simply placing your hand on the bottom of the steering wheel, then moving your hand left (wheel turning right) will move the trailer to the left and vice versa.

On the road, maintain a safe driving distance from other vehicles. A safe driving distance is the total length of your towing vehicle and folding trailer combined for each ten miles per hour of speed.

When approaching a downhill grade, downshift, letting the engine compression act as a brake. Should you need added braking, apply your brakes as required.

When approaching an uphill grade, the answer is the same - downshift. This keeps the engine from lugging down which may overheat from laboring in a higher gear.

Your towing equipment, its adjustments and how you load the trailer will have a great effect on trailer towing stability and handling.

- * Use a tow vehicle that is large enough for your trailer and has the needed power and appropriate towing equipment package.

Hitching up your trailer will become routine with experience. Make it a habit to examine all hitch components before hitching the trailer. If you have a conventional ball hitch, check for cracked or bent parts, cracked welds, and deformed or stripped bolts. Be sure the hitch ball is tight and well lubricated. Inspect the safety chains. If you find defects in any hitch component, correct it before towing the trailer.

When weighing your trailer always use a platform scale such as those used by trucking companies or highway weigh scales.

Gross Axle Weight Rating (GAWR) - Weight carrying capacity of the axle while the trailer is in tow.

Gross Vehicle Weight Rating (GVWR) - The maximum loaded weight the trailer can safely accommodate while in tow.

1. **Weigh the trailer by itself.** After driving the tow vehicle and trailer onto the scale, disconnect the trailer from the tow vehicle and move the tow vehicle off the scale. The measured weight of the loaded trailer must not exceed the GVWR of the trailer. Cargo or equipment items must be removed until the GVWR is not exceeded.
2. **Find the tongue weight.** When the total trailer weight is under the rated GVWR, you next determine the trailer tongue/coupler weight.

For conventional trailers: Move the trailer until the tongue is off the scales. Relevel the trailer by adjusting the height of the tongue jack. Read the trailer weight on the axles alone. Subtract weight on the axle from the total weight. This weight difference will be the approximate tongue weight.

WARNING:

Do not exceed the rated load of the tow vehicle, the trailer, or the rated load of any axle.

WARNING:

Exceeding the GAWR or GVWR of your tow vehicle or trailer can cause undesirable handling characteristics and may create a safety hazard.

C. Tips on Picking a Campsite

DO . . .

Find a level spot that gets some breeze or wind. The breeze will improve ventilation in your trailer and keep bugs away.

Try to find a site with trees that will provide shade in the afternoon when the sun can get unpleasantly hot.

WARNING:

Camp on high ground, not in river or creek beds where flash floods can prove to be a danger.

Locate the trailer reasonably near water facilities, toilets, and electrical hookups.

DON'T . . .

Pick a site near a busy road or boat dock. Late-arriving campers and early-rising fishermen can cause you to lose sleep.

Pick a site near standing water or swampy area. These are obvious breeding grounds for mosquitoes.

Park near any tree that has large dead branches that may blow down on your trailer.

SET-UP INSTRUCTIONS

GETTING STARTED

Prior to the initial camping trip, familiarize yourself completely with the operation, care and construction of your new Fleetwood folding trailer. Upon your first camp, we suggest that you set up your Fleetwood folding trailer slowly and per the set-up instructions to prevent unintentional damage to the equipment.

1. Select a level campsite, preferably not on soft or sandy terrain.
2. Pull or back the trailer to desired position for campsite.
3. Disconnect electrical pigtail and safety chain, and release the coupler release handle. See Figure 1.
4. Pull the lock pin (located on the tongue jack) and let the tongue jack swing down into position. Allow the lock pin to lock the tongue jack in place in the top left hole in the brackets. See Figure 2.

CAUTION: Failure to engage the tongue jack lock pin could result in the trailer tongue falling resulting in injury to yourself or others. On the Roanoke/Cedar models, the tongue jack serves as the front end stabilizer and should never be unlocked from its setup position when the trailer is open.

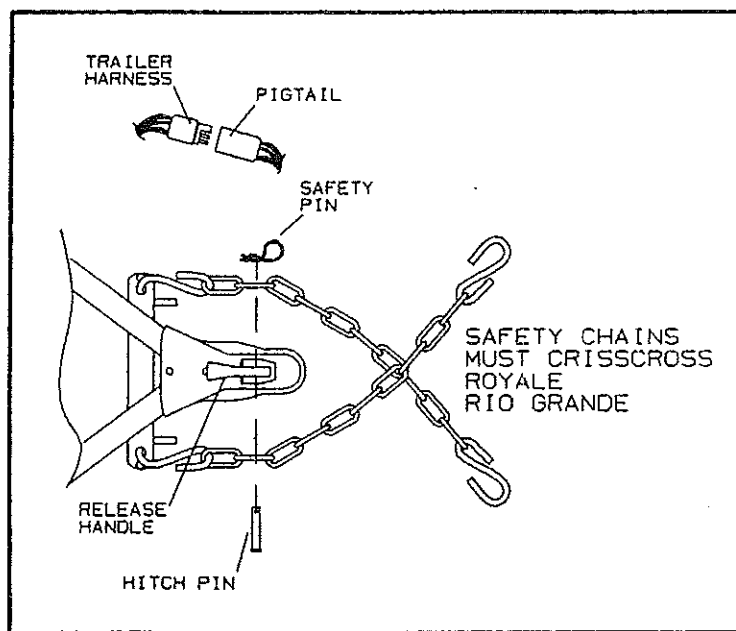

FIGURE 1



FIGURE 2

5. Pull the handle of the tongue jack up and rotate the handle in a clockwise motion to lift the trailer tongue up and off the ball hitch. Place wheel chocks to prevent trailer from moving.

6. To prevent interference during the set up of the trailer, drive the vehicle away from the trailer or move the trailer to the desired location for the campsite.
7. Adjust the tongue jack height so that the trailer is level horizontally.
8. Unlatch the four "top" latches. See Figure 3.
9. Remove the crank handle from its storage location and attach it to the crankshaft located at the center of the rear bumper. See Figure 4.
10. Rotate the crank handle clockwise slightly to release tension on the crank lock. Using your free hand, pull outward on the crank lock to allow top to be raised. See Figure 5. Rotate the crank handle clockwise to raise the top until it is fully extended or the tent fabric becomes reasonably taut, whichever occurs first. See Figure 6

CAUTION: Keep a constant inward pressure on the crankshaft to prevent the crank handle from backing off the crankshaft.

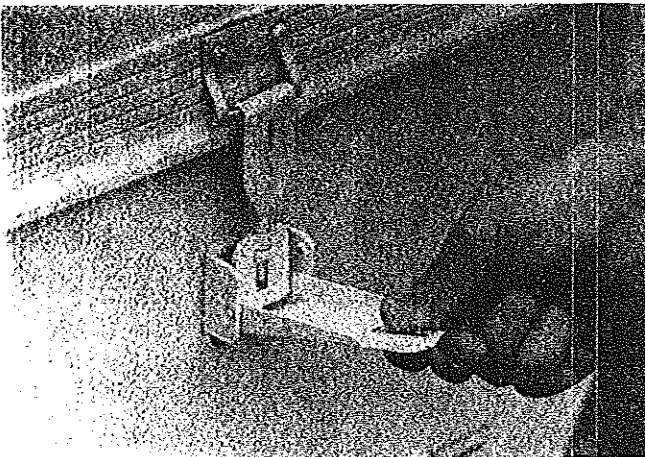

FIGURE 3

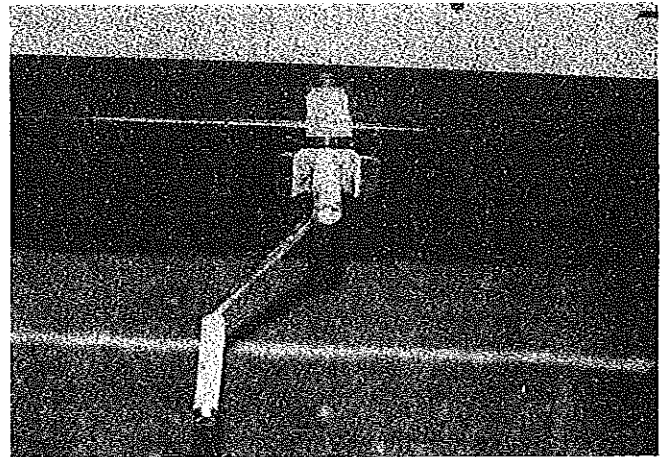

FIGURE 4

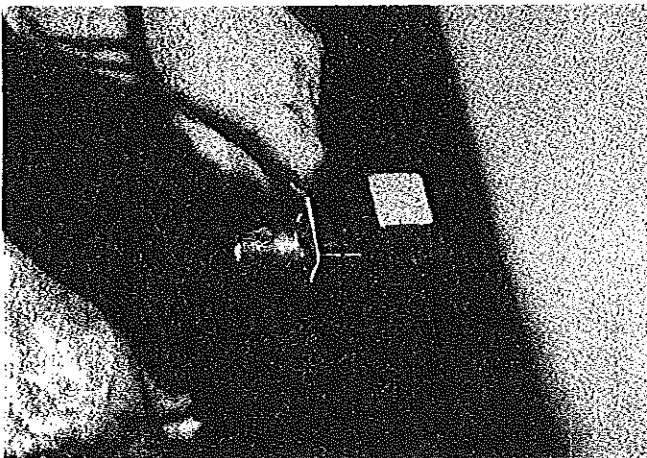

FIGURE 5

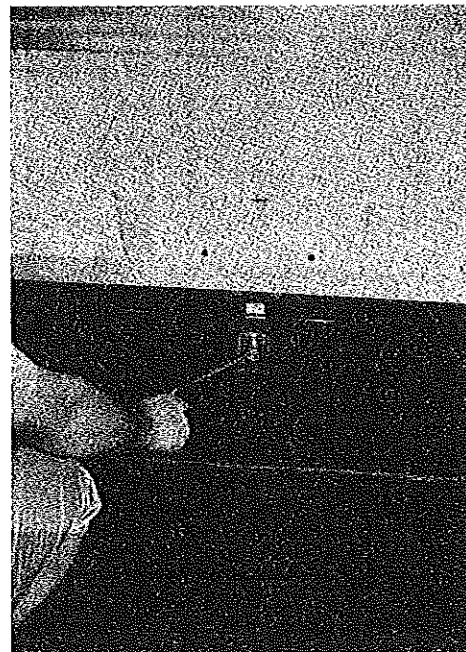

FIGURE 6

11. On all Destiny series trailers, it will be necessary to engage the crank lock (located on the rear bumper), by pushing inward to secure the top in the up position once fully raised. See Figure 7.

NOTE: Crank handle may have to be rotated slightly to the left or right to allow the crank lock to engage.

WARNING: Failure to engage the crank lock after raising the top will cause accidental top assembly descent which could result in bodily injury. At no time should the crank handle be removed from the crank shaft while the top is raised unless crank lock has been engaged.



FIGURE 7

IMPORTANT: DO NOT crank the top to an extreme tautness, otherwise the cables can become stretched or broken.

STABILIZER JACKS

IMPORTANT: DO NOT lower the stabilizer jacks prior to raising the trailer top as this can place an undue stress on the trailer frame and lift system resulting in premature wear.

WARNING: Do not use the stabilizer jacks to take the weight of the trailer off of the tires EXCEPT when changing a flat tire. The jacks are intended ONLY to "stabilize." If the entire weight of the trailer is placed on the stabilizer jacks, irreversible damage may occur and may interfere with the functioning of the screen door due to the flexible nature of the C-channel frame construction.

WARNING: Do not lie under trailer when putting stabilizers down or up. Should the trailer fall, serious bodily injury could result.

NOTE: When the trailer has been over rough terrain and the stabilizer jacks have collected road tar, mud, or brush, it may be necessary to dislodge the foreign matter from the stabilizer jacks before lowering into position.

12. The Roanoke and Cedar models are equipped with three stabilizer jacks, one in each rear corner and one on the front left side of the A-Frame opposite the tongue jack. The Royale and Rio Grande are equipped with four stabilizer jacks, one in each rear corner of the trailer and one on either side of the A-frame near the front frame cross channel. To release the stabilizer jacks from the locked travel position, reach under the trailer, firmly grasp the jack and push it toward the center of the trailer (approximately 1/2"), and swing down to lock the jack in the lowered position. See Figure 8.
13. Each stabilizer jack has an inner leg which must be extended to the ground. Because of certain terrain conditions, it may be advisable to locate flat blocks of wood or flat rocks under the base plates of the stabilizer jacks.
14. Remove the stabilizer jack handle from the recommended storage location. Making sure the handle is inserted through the rear hole, apply downward pressure to extend the inner legs of the stabilizer jacks to stabilize the trailer. See Figure 9. Remove jack handle and stow.

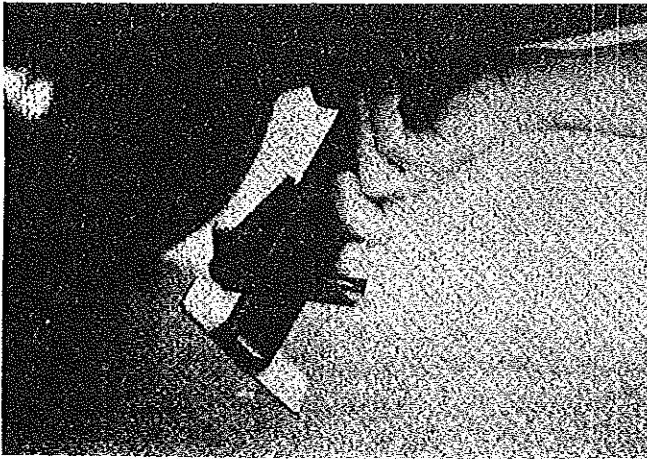

FIGURE 8

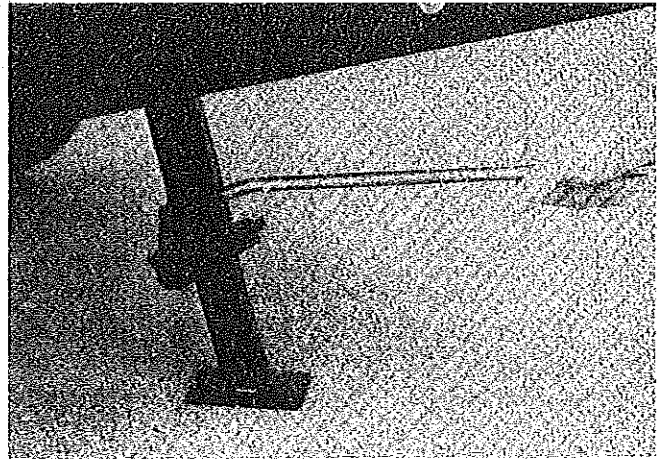

FIGURE 9

BED SET-UP

Roanoke/Cedar Front and Rear Beds

Royale/Rio Grande Rear Bed

15. Standing at the center of the bed, place hands approximately 1 1/2 feet apart on the bed frame and pull until the bed is fully extended (hits the stops). See Figure 10.

IMPORTANT: This movement must be done slowly and evenly to prevent inadvertent jamming or wedging of the bed within the sliding tracks.

IMPORTANT: DO NOT put any weight on the beds while they are extended without first attaching the bed supports (located under the beds) as damage to the bed frame may result. Any damage to the bed frame, resulting from weight being applied to the bed area without the bed supports in position, will not be considered a warranty item.

16. Kneel down beneath the side of the fully extended bed. Pull down and swivel the two bed support tubes from their travel positions. Lift the bed slightly while placing the free end of the bed support tube over the support peg which is permanently attached to the trailer. See Figure 11.

IMPORTANT: Be sure the bed support leg is fully engaged on the support peg otherwise any weight placed on the bed will cause damage to the bed side frame.



FIGURE 10

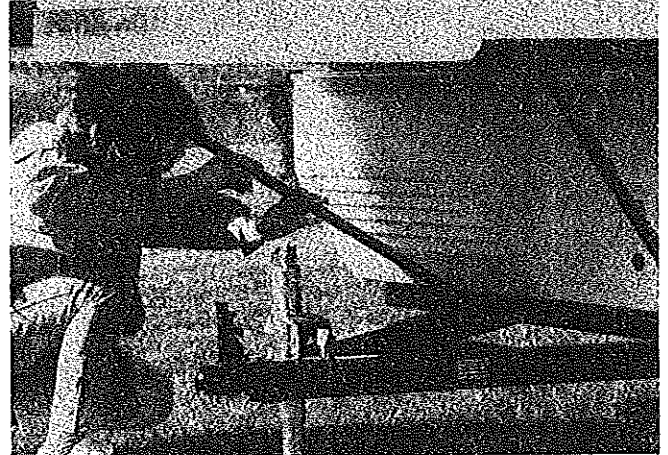

FIGURE 11

Royale/Rio Grande Queen Size Front Bed

IMPORTANT: The Royale/Rio Grande queen size front bed has four supports (two portable and two attached). Do not attempt to pull out the queen bed until both front portable bed supports are properly installed.

17. Remove the two portable bed supports from their storage location under the front mattress. See Figure 12. Standing at the front of the trailer, locate the four support holes on the top edge of the front body rail (two holes on each side). Taking the first support, carefully insert the two pins (located at one end of the support) into the two pilot holes located on the top edge of the front body rail. Place the free end of the bed support tube over the support peg located on the trailer frame. See Figures 13 and 14. Repeat the same procedure for the other support.



FIGURE 12

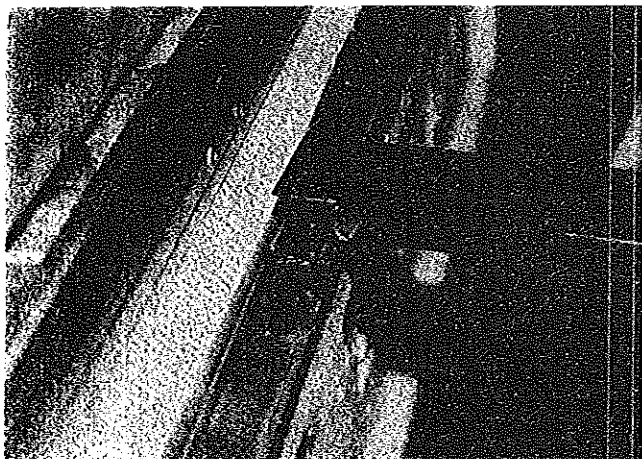

FIGURE 13

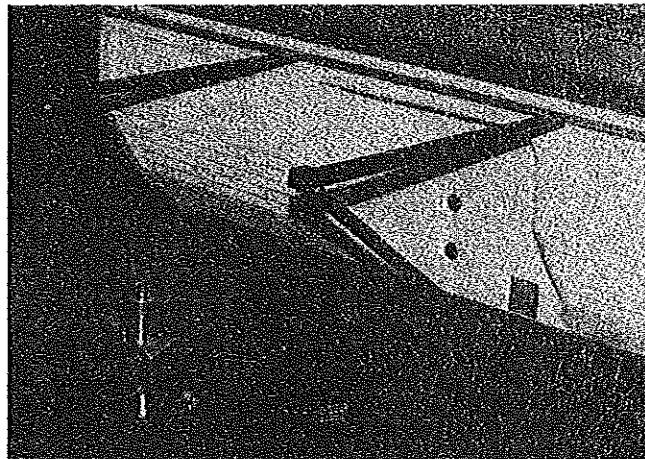

FIGURE 14

18. Once the two portable bed supports are in place, the front bed is now ready to be pulled out. Standing at the center of the bed, place hands approximately 1 1/2 feet apart on the bed frame and pull until the bed is fully extended (hits the stops).
19. Kneel down beneath the side of the fully extended bed. Pull down and swivel the two bed support tubes from their travel positions. Lift the bed slightly while placing the free end of the bed support tube over the support peg which is permanently attached to the trailer. See Figure 11.

IMPORTANT: Be sure the bed support leg is fully engaged on the support peg, otherwise any weight placed on the bed will cause irreversible damage to the bed slides.

NOTE: The portable bed supports may be folded up and stored under each mattress for travel. See Figure 12.

IMPORTANT: As the bed is pulled out, the movement must be done slowly and evenly to prevent inadvertent jamming or wedging of the bed on the sliding rails. See Figure 10.

TENT ENCLOSURE SET-UP

20. With both beds fully extended and supported, grasp the bottom edge of either the front or rear tent enclosure with hands approximately 2 1/2 feet apart and gently pull until the tent fabric is pulled out toward the end of the wing beds. See Figure 15. Standing at any side of the wing bed, reach in underneath of the tent fabric and grasp the side of the canvas bow and rotate toward the end of the bed. See Figure 16.
21. Pull the tent at the bottom over the bed edge and attach the exposed stretch cords to the nearest hooks on the underside of the bed. Repeat for other bed end. See Figures 17 and 18.

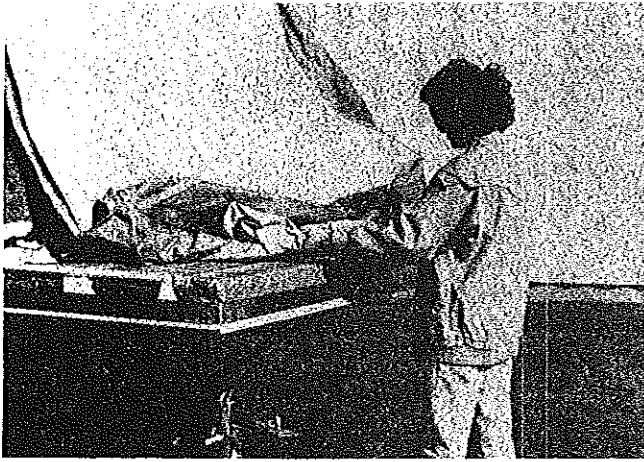

FIGURE 15

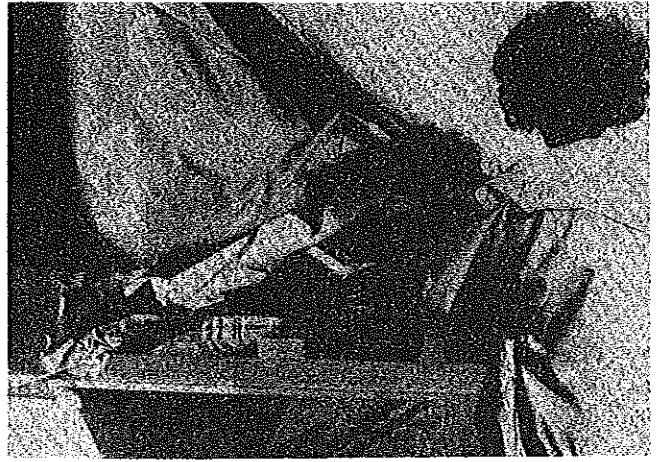

FIGURE 16

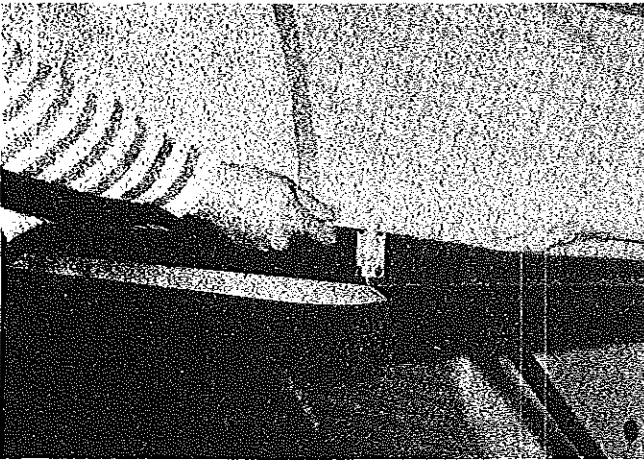

FIGURE 17

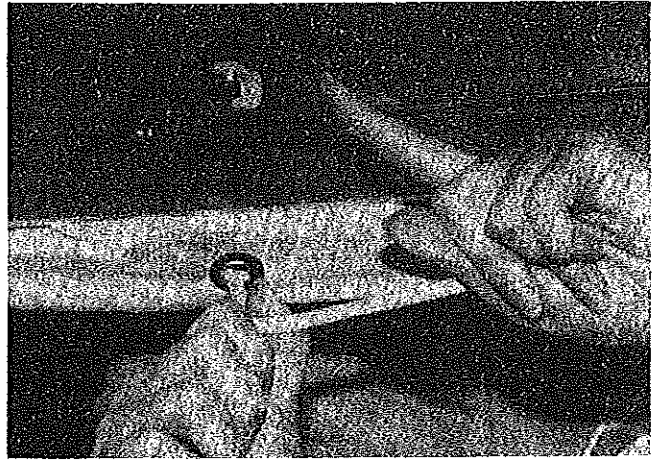

FIGURE 18

22. From the right side of the trailer, insert the key into the lock (located on the right front body panel) and turn 90° clockwise. The pushbutton and handle will pop out. See Figure 19. Rotate the handle 90° clockwise to open the access door. Pull out on the access door to open. The door can now be locked into the open position by engaging the swing latch located on top of the door onto the stud on the curbside rear body rail. See Figure 20 and 21.



FIGURE 19



FIGURE 20

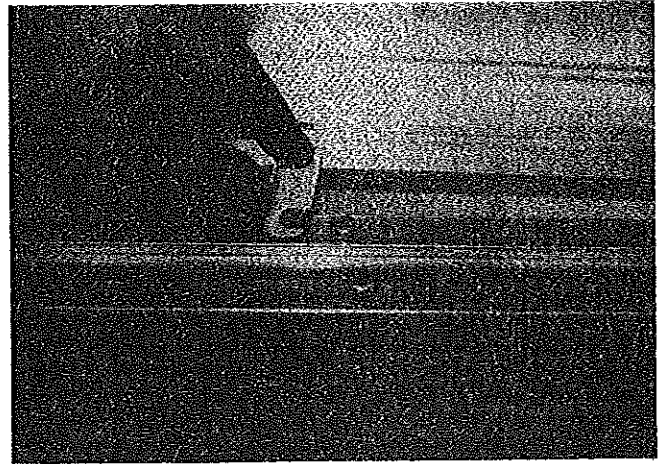

FIGURE 21

SCREEN DOOR SET-UP

23. Unfasten the two screen door web retaining straps. This will allow the screen door to hang by its glide cables.
24. Standing at the door opening, pull down on the spring-loaded pin clip retaining the door frame and swivel clear of the engagement hole. See Figure 22. Standing at the door threshold, reach up and grasp the bottom of the screen door with both hands. Raise and push the door toward the far side of the trailer to release it from its retaining brackets. See Figure 23.

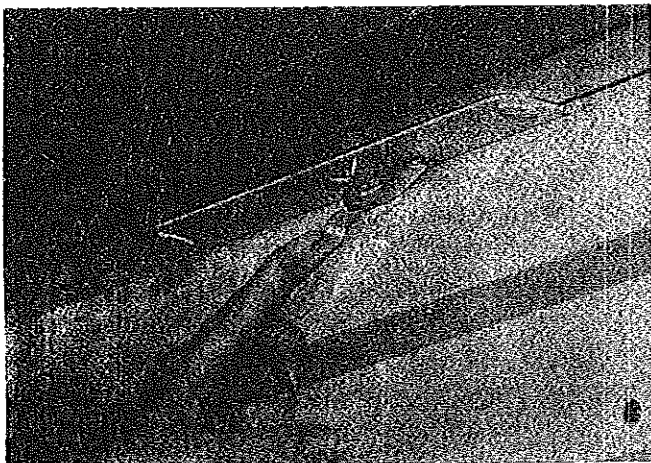

FIGURE 22

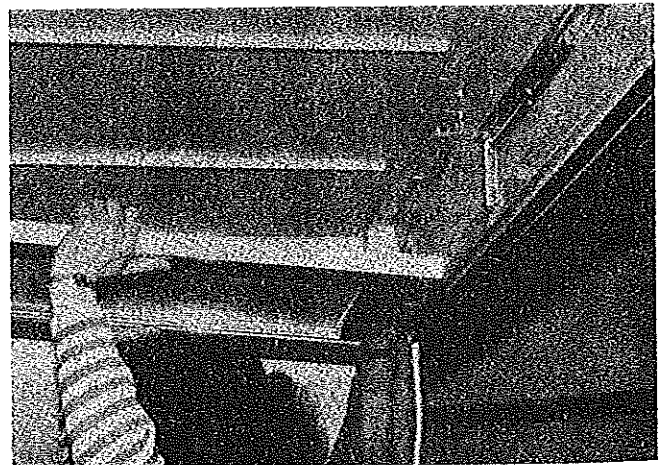

FIGURE 23

25. Hold screen door up from the floor and move it toward the door opening.
26. Step outside and grasp the door frame with both hands, one on either side, lower screen door into doorframe threshold at base of doorway. See Figure 24. Unlock screen door latch and step inside.

27. From either side of the screen door, grasp the top extrusion with one hand. Using your free hand, guide the screen door lock tabs into the preslotted top plate. See Figure 25. Turn the lock tabs 90° to secure the screen door to the top assembly. See Figure 26.

Attach the tenting material on to the mating velcro on the screen door top plate. See Figure 27.



FIGURE 24

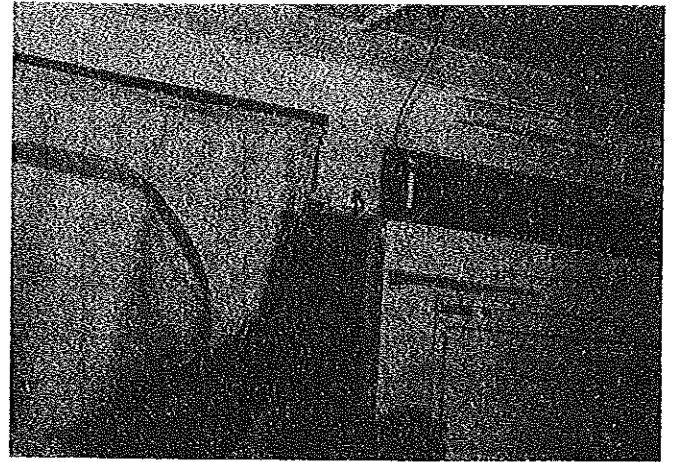

FIGURE 25

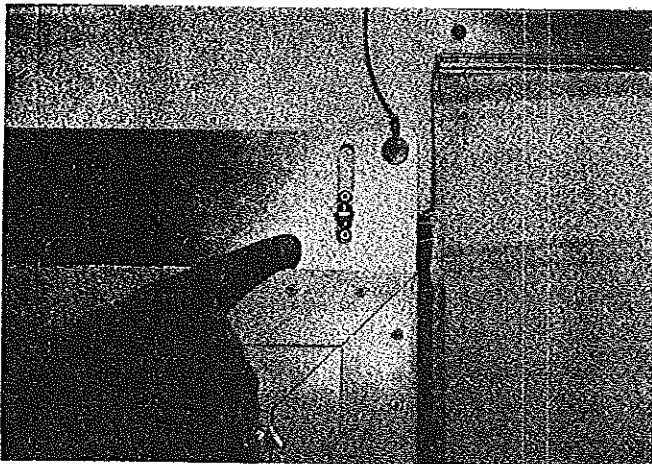

FIGURE 26

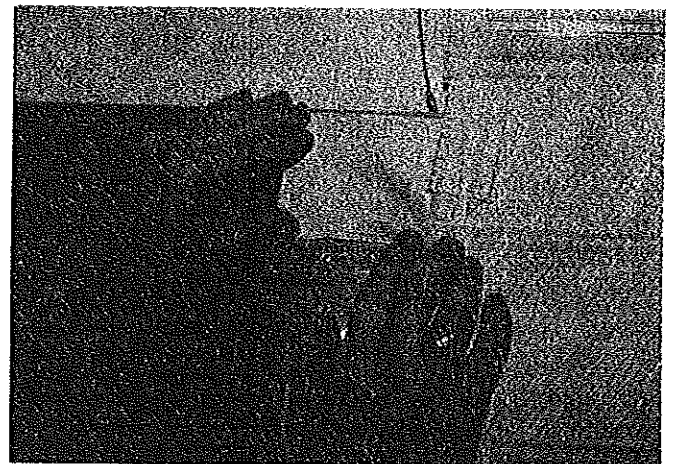

FIGURE 27

28. From inside the trailer start at the base of the tent material and press the tent weatherseal on either side of the door into the weatherseal groove on the door frame. See figure 28.

NOTE: On very tight tents, set-up is much easier if the screen door weatherseals are installed prior to attaching the tent at bedends. Rest each bed tent on top of the beds, install the weatherseals, and then pull the tent over the bed edges.

FIGURE 28



HINGED GALLEY/STOVE CABINET SET-UP

Hinged Upper Galley (All Models)

29. Grasp the towel rack of the upper galley assembly. Lift up and rotate 180 degrees toward the outside of the trailer. See Figure 29.

IMPORTANT: Be sure the upper galley is securely latched to the lower cabinet top retaining latch. A click can be heard as the retaining latch engages. See Figure 30.

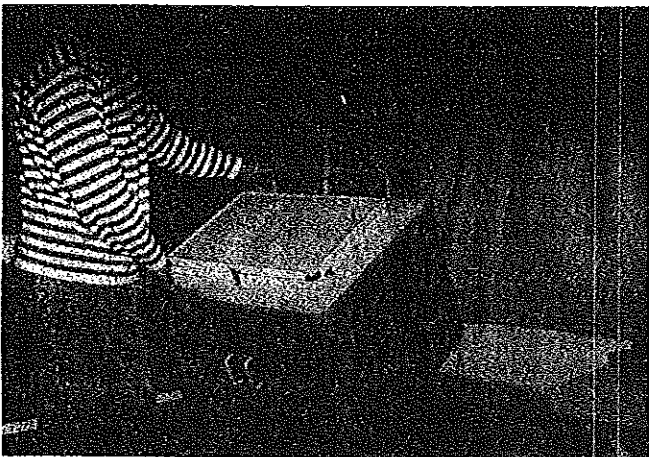

FIGURE 29

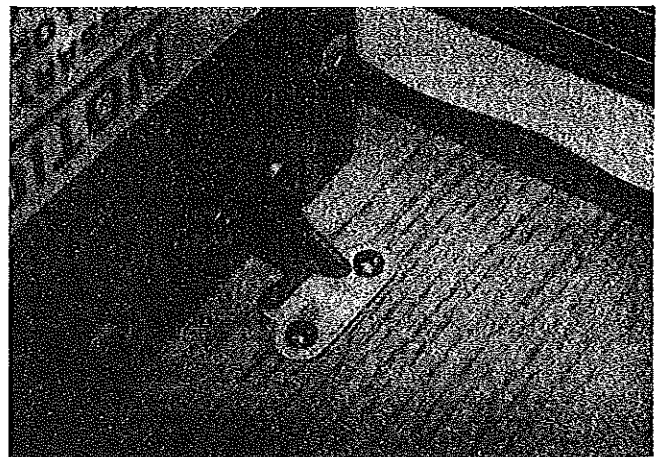

FIGURE 30

Stove Cabinet - Roanoke

30. Move stove cabinet from floor storage location and position into cut out on hutch cabinet top. See Figure 31.

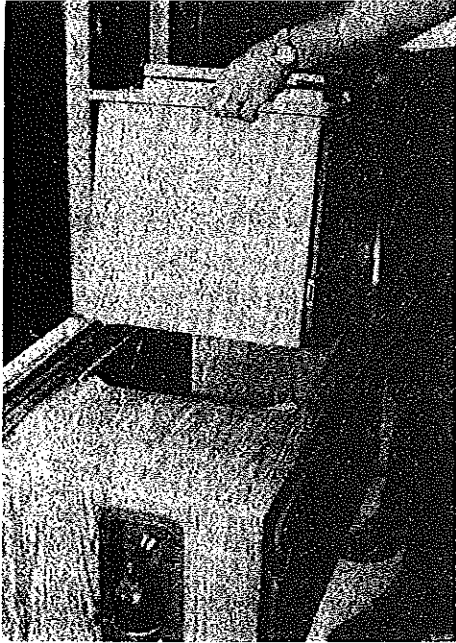

FIGURE 31

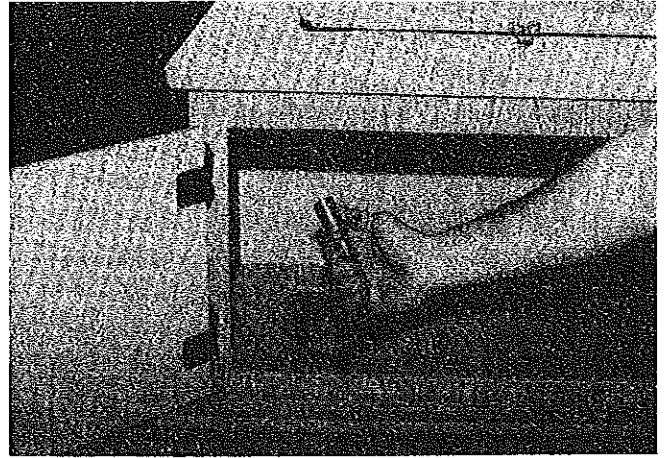

FIGURE 32

31. Locate gas line and route into stove cabinet through opening in hutch cabinet top. See Figure 32.
32. With the stove valve in the **off** position engage the gas disconnect to the stove assembly and open the gas valve. See Figures 33, 33A and 33B.

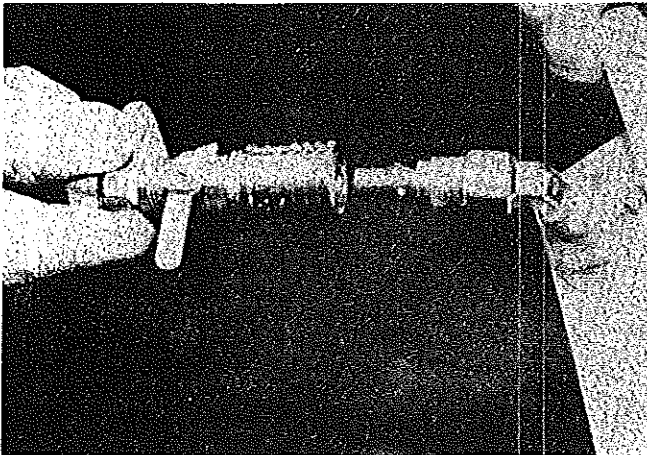

FIGURE 33

OPEN VALVE

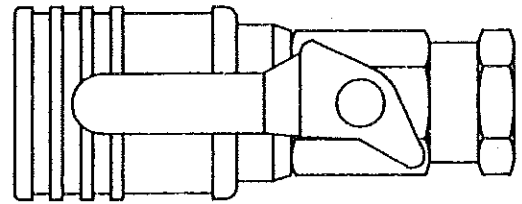

FIGURE 33A

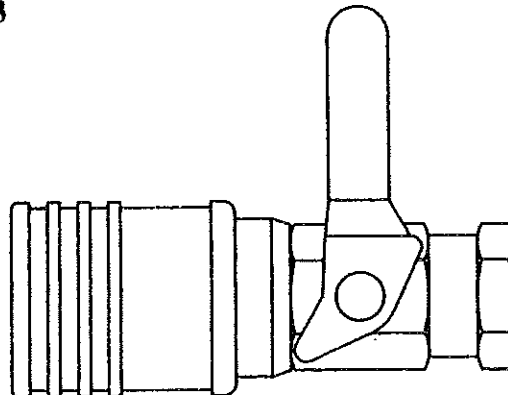

FIGURE 33B

CLOSED VALVE

INSIDE/OUTSIDE STOVE SET-UP

A. Inside Use: (All Models)

33. Unfasten the catch securing the stove cover. Raise the stove cover into position. Rotate the splash guard toward the outside of the stove and fasten to the side of the cooktop. See Figure 34.

IMPORTANT: Do not place hot cooking utensils on cabinet tops or table top. Damage to surface could occur.

WARNING: Always ensure the retaining lock tabs are engaged when utilizing the stove in the inside location. See Figure 35.

34. Check to insure all burners on the stove unit are turned off. Open the valve on the LP gas bottle all the way by rotating the handle in a counterclockwise direction.

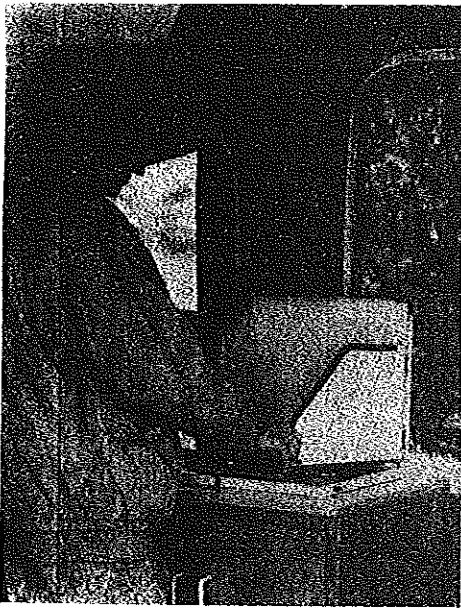

FIGURE 34



FIGURE 35

WARNING: When trailer has been over rough terrain, test gas piping and appliances with soapy water for leakage. **DO NOT** test with a lighted match. **DO NOT** tamper with the gas bottle regulator; it is factory adjusted. Failure to adhere to this warning could lead to an undetected gas leak resulting in fire and/or explosion.

CAUTION: Do not check copper and brass plumbing lines and fittings for leaks using ammoniated or chlorinated household type detergents. These can cause cracks to form on the line and brass fittings.

35. Turn on one LP burner on the stove unit and hold a lighted match near the LP burner.

NOTE: Initially, it will take 20-40 seconds for the gas to flow from the bottle to the burner after which the LP burner will ignite.

B. Outside Use: (All Models)

The following steps should be followed to remove the stove from the inside location in order to utilize the outside location.

36. Turn the lock tabs (located on the underside of the stove) 90 degrees to unlock stove from retaining bracket. See Figure 35.
37. Grasp the towel bar and raise the stove module until the bottom of the stove box clears the galley top and slide approximately 6". See Figure 36.

FIGURE 36

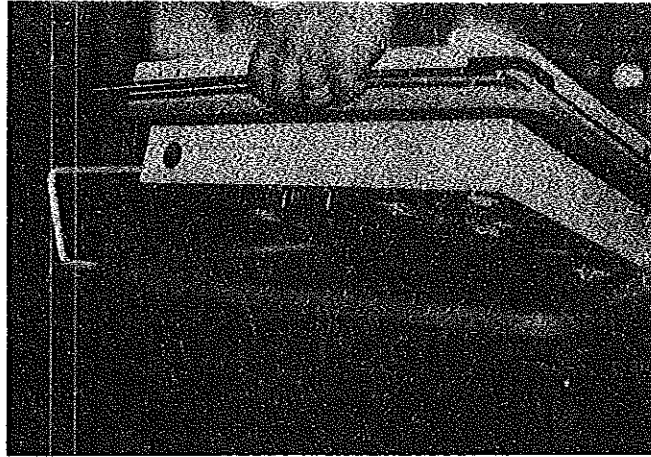

38. Disconnect the gas supply line by first turning the gas shut off valve to the "OFF" position. See Figure 33.

WARNING: Care should be used when disconnecting gas. Never disconnect the stove valve while smoking or with open flame nearby. A small amount of excess gas will be released from the stove module at the time of disconnection.

39. Carry the stove module outside the trailer.
40. Holding the stove module with both hands, engage the stove hangers onto the retaining brackets located on the body rail directly above the access door. See Figure 37.

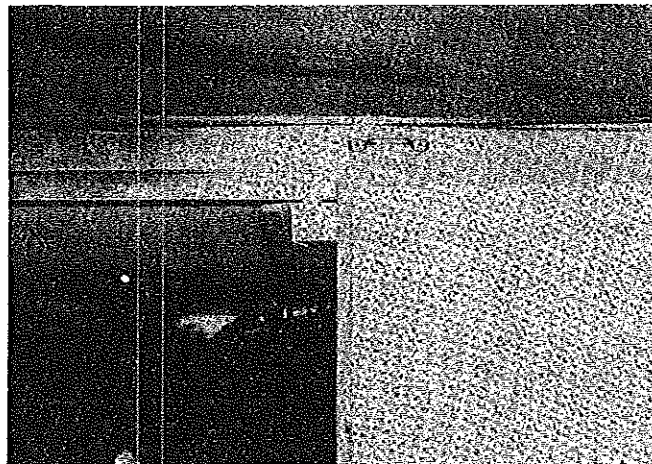

FIGURE 37

41. Locate the stove mounting bracket and remove from storage location on the access door. See Figure 38.

NOTE: On Royale/Rio Grande models the stove mounting bracket is stored within the trailer.

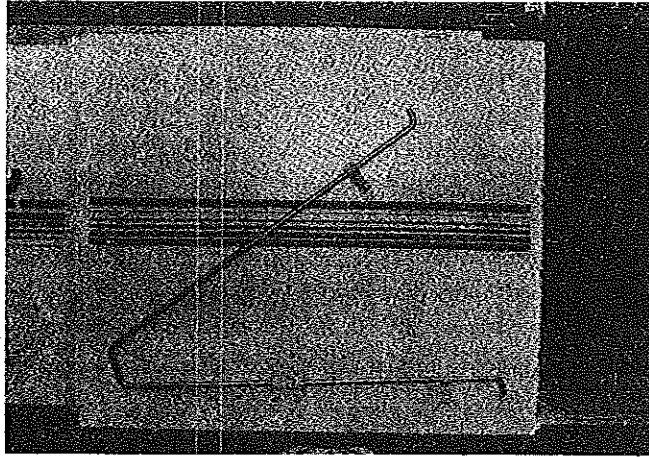

FIGURE 38

42. Position the stove mounting bracket removed in Step 41 onto the two retaining loops located on the bottom front of the stove module. Tilt the stove slightly upward and engage the bottom portion of the mounting bracket on to the metal bracket located on the lower section of access door. See Figure 39.

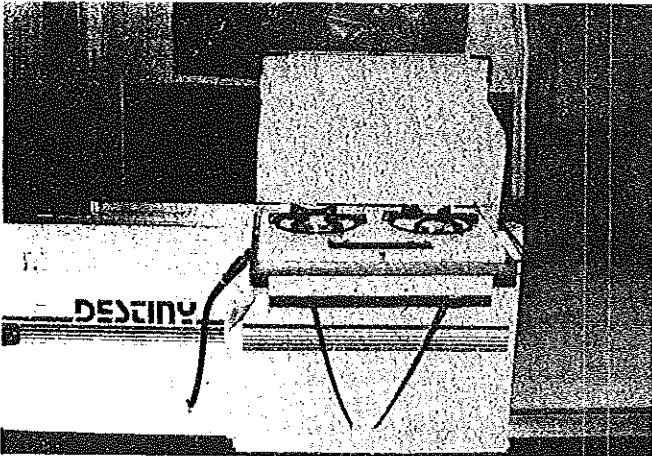

FIGURE 39

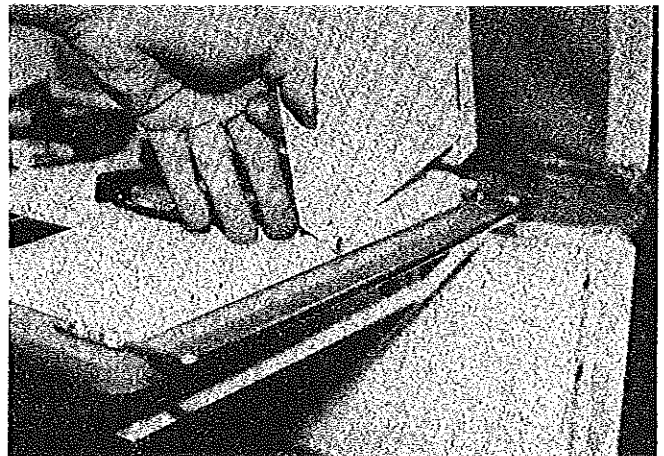

FIGURE 40

43. Open the utility port on the curbside body panel and expose gas line. See Figure 39.
44. With the valve in the "OFF" position, engage the gas disconnect on to the stove module and open the gas valve. See Figure 33.
45. Prior to lighting the stove, open the stove cover and secure the splash guards on both sides of the stove cooktop. See Figure 40.

NOTE: In order to obtain full counter space when the stove is being used in the outside position, a specially designed cutting board can be placed into the counter top cut out.

46. Follow instructions in reverse order to move stove module back to the inside galley position.
-

DINETTE SET-UP

47. Lift the backrest off of the dinette table and set aside. Slide each seat cushion inboard. Set each backrest in place vertically. Slide the seat cushion in place making sure that the plastic stops are wedged firmly against the interior of the seat frame.

NOTE: To lift dinette seat, be certain to push the seat cushion firmly toward the backrest wall before lifting in order to prevent inadvertent damage to the plastic stops. See Figure 41.

48. Extend the table legs completely so that both leg supports lock into position. Set table upright and check to insure it is stable. See Figure 42.

CAUTION: The table top could be damaged by exposure to rain or extended periods of sunlight.

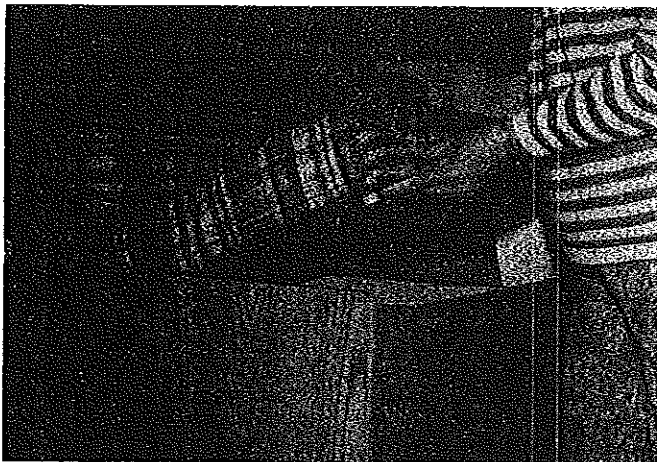

FIGURE 41

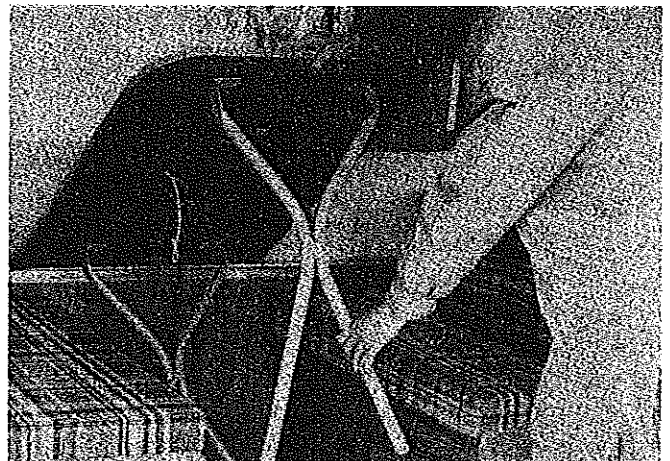

FIGURE 42

BED BOW SUPPORT SET-UP

49. Adjust bed bow support as necessary to make the tent enclosure over the bed taut. This is done by pressing the release button on the pole and extending the rod to the next hole location. See Figure 43.

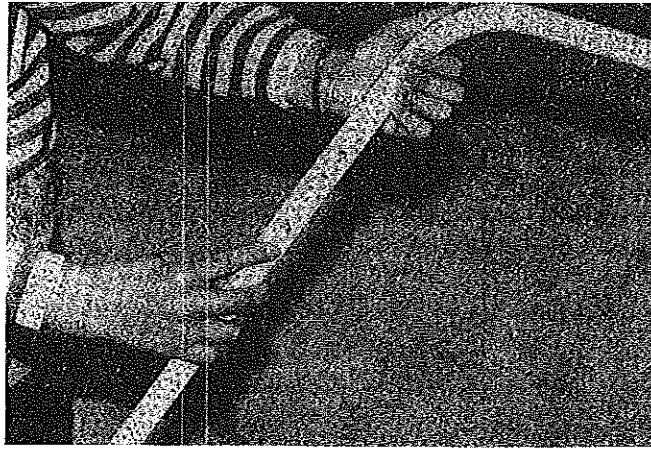

FIGURE 43

50. To completely support the tent enclosure over the bed (front and rear), attach the bed bow support by inserting the straight end into the bed bow. Insert the rounded end of the bed bow support into the roof retainer. See Figures 44 and 45.

IMPORTANT: Do not force bed bow support to extreme tautness. This may cause damage to the seam area of the bed end tent enclosure.

NOTE: These may be stored in a preadjusted state under each mattress.

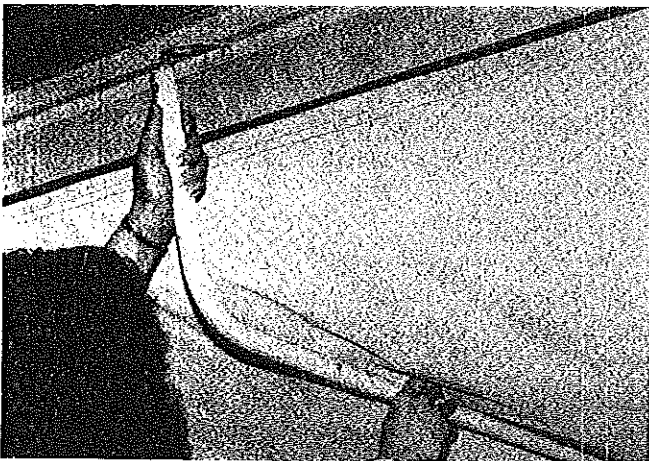

FIGURE 44

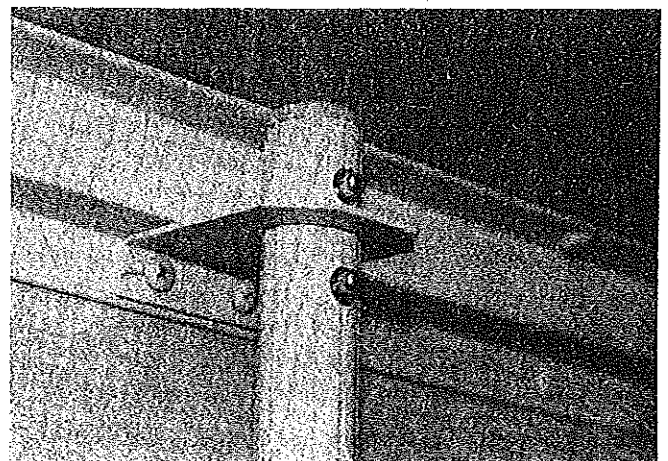

FIGURE 45

ELECTRICAL AND WATER HOOK-UPS

51. When the campsite provides a pressurized water system: Remove the protective cap from the external pressure water connector. See Figure 46. Attach a non-toxic garden hose (not furnished) between the external trailer connection and the campsite-furnished faucet.

NOTE: Since water pressures at campgrounds vary, we recommend you install an inline pressure regulator (not supplied with trailer) at the water supply faucet. This will protect both the trailer water system and your supply hose from excessively high water pressure.

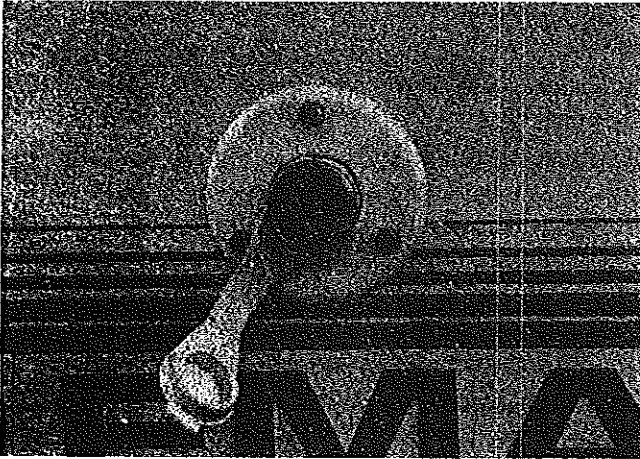

FIGURE 46

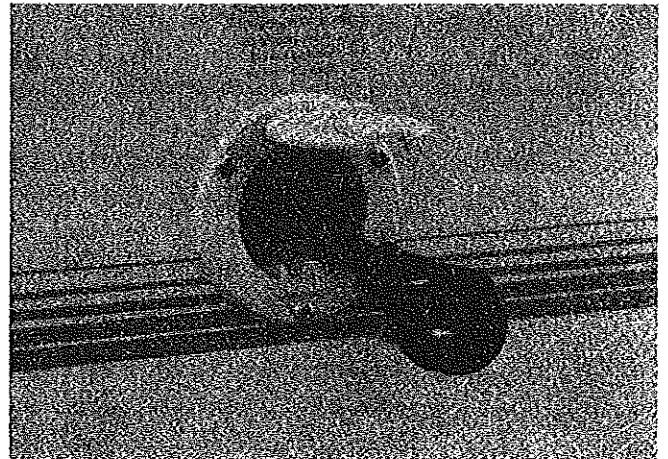

FIGURE 47

52. If the campsite does not provide a pressurized water system, it will be necessary to use the portable five-gallon water tank provided. The five-gallon water storage bottle can be removed from inside the trailer and filled at a suitable water filling station.
53. Connect the waste system hose (not supplied) to the end of the drain fixture as identified on the panel of the trailer by the "DRAIN" decal and to the park sanitary system or suitable waste container.

CAUTION: Do not interchange waste system hose and fresh water hose as contamination to the water supply could result.

54. When the campsite provides an electrical system: Lift up the cable hatch cover, grasp the self-storing power cord plug and pull it out. See Figure 47. Plug the power cord into the campsite-provided outlet. From inside the trailer at the power supply center, set the converter switch to the "CONVERT" position.

WARNING: The electrical system is rated for a maximum 30 amperes normal household-type current. Be sure not to exceed this rating. Excessive amperage draw could cause electrical system problems. Be sure any outlet the trailer is plugged into is grounded and has the correct polarity.

CONVERTER:

The converter changes the 115 volt park supply to 12 VDC for operation of the interior 12 volt lights and certain 12 volt appliances (i.e., furnace). The receptacles inside the trailer carry the 115 volt current for operation of 115 volt appliances and the like. Set the converter switch in the "convert" position for this type operation.

When the converter is set to "BATT," the interior electrical lights must be serviced by an external 12 volt battery for the electrical supply. This external battery could be the tow vehicle battery or an auxiliary battery.

NOTE: The converter contained within the trailer will not recharge a tongue mounted battery.

CAUTION: Ensure interior top lights are turned to the off position when closing the trailer in the travel position.

WARNING: Do not use or store a battery inside the trailer. Battery acid leakage or explosion could cause bodily injury or death.

On the tongue of the trailer are two 12 volt DC wiring harness connectors. The Roanoke and Cedar have a four-prong connector and the Royale and Rio Grande has a six-prong connector which connects to the tow vehicle for the operation of running lights, brake lights, and so forth. Each model also has a two-prong connector which is for the operation of the 12 volt interior lighting system and optional furnace. In order to use the two-prong receptacle, it is necessary to purchase the 12 volt auto extension cord from your dealer. This cord may be plugged into the tow vehicle cigarette lighter to provide 12 volt power to the interior of your camper.

IMPORTANT: Never allow the 12 volt, two-prong receptacle to be plugged in while the trailer is in the closed position. Excessive heat build up in the interior lights could cause damage to the tent material of your camper.

TAKE-DOWN INSTRUCTIONS

1. From inside the trailer, flip the converter switch to the "OFF" position.
2. Disconnect the power cord from the campsite outlet and return the cord and plug to its storage location and close cable hatch.
3. Disconnect the non-toxic garden hose from the campsite-provided faucet and the external trailer connection. Stow the hose.
4. Attach the protective cap onto the external city water connector to prevent foreign matter from entering the internal water system.
5. Disconnect the waste system hose from the external trailer connection. Thoroughly rinse the hose and store. Replace drain cap dust cover.
6. Close the valve on the L.P. gas bottle all the way by rotating the handle in a clockwise direction until the valve seats.

CAUTION: Do not attempt to operate any propane appliance while the trailer is in tow.
7. From inside the trailer, open and light one L.P. burner and allow to burn until flame extinguishes. This will safely and effectively bleed the system.
8. Turn L.P. burners to off position. Pull stove cover down and secure for travel with catch. See Figure 34.

NOTE: For quicker camp set-ups at a later time, it may be desirable to leave the drapes up throughout the trailer. The drapes may wrinkle slightly, but the wrinkles will fall out during the next camp set-up. If drapes are left hanging, be sure to unhook drapery ties.
9. Detach both front and rear bed bow supports from the roof retainer and from the bed bow. Lay the bed bow supports under each mattress. See Figure 44.

NOTE: Remove any accessories that are mounted to the top assembly (i.e., wardrobe rack, vanity board, or overhead cabinet) if the trailer is so equipped.
10. Lift the dinette table up on end. Apply inward pressure to the leg support locks and lower and secure legs by attaching the elastic cord over both dinette legs.
11. Secure the dinette table by locating it on the rests between the bench seats. See Figure 42.
12. Remove the backrests from their positions. Slide the seat cushions outboard and place the backrests, cushion side down, on the stored dinette table.
13. While inside the trailer, begin at the top of the screen door frame and carefully pull the tent weatherseal on either side of the doorframe from the weatherseal groove attached to the doorframe.
14. Release the top door lock tabs. Lock the screen door latch and step outside the trailer. Grasp the doorframe with both hands, one on each side, and lift up and remove from the door threshold and allow the door to tip inward. See Figure 26.

15. Grasping the bottom of the doorframe, lift up and push the top of the door toward the far side of the trailer. Place the bottom of the door onto the pins on the retaining bracket and lock spring-loaded pin clip into base of door frame (see Figures 22 and 23) and snap web retaining straps. Be certain door is securely engaged on all three pins.

Hinged Upper Galley

16. Grasp the towel bar of the galley unit, reach behind the galley at the left far corner and release the retaining latch by depressing the lock while raising and rotating the galley unit 180° to the inside of the trailer and lower gently to the floor. See Figure 29. Snap the web strap to secure the flexible gas line for travel (where applicable).

(Stove Module, Roanoke Model) From inside the stove module disconnect gas line. See Figure 32 and Figure 33. Carefully lift the stove module to its storage location on the floor between the front dinette seat and cabinet. This should be the last step in closing up the inside of the trailer for travel other than positioning the cooler just inside the access doorway.

17. Step to the tongue end of the trailer. Release the exposed stretch cords from the hooks located under the extended bed.
18. Pull the tent up and over the bed edge. Grasp the bed bow and push toward the center of the trailer until it lays flat on the bed. Insure that the tent material is evenly distributed over the bed to facilitate closing of the top assembly.
19. Kneel down beneath the right side of the extended front bed. With one hand, raise the bed gently and with the other hand remove the bed support tube from over the support peg. Swivel each support tube up and lock into the travel position. See Figure 11.
20. Repeat step 19 for the left side.
21. Insure the tent fabric is up away from the bed edge. Standing at the center, place hands on the bed frame and push until the bed hits the stops. This movement must be done slowly and evenly to prevent inadvertent jamming or wedging of the bed on the sliding tracks. See Figure 10.

NOTE: On the Royale and Rio Grande front bed, it will be necessary to disassemble the removable bed supports and stow. See Figure 12.

22. Perform steps 19 through 21 for the rear bed.
23. Set up the trailer tongue jack on Royale/Rio Grande model if it was previously retracted to the towing position.

CAUTION: Be sure the tongue jack is supporting the trailer tongue and is locked in position to prevent sudden collapse of trailer tongue.

IMPORTANT: Do not lower top unless the stabilizers are released.

24. Remove the stabilizer jack handle from the storage location.
25. Press on the quick-release lever of the stabilizer jack with the jack handle and push downward slowly. This releases the stabilizer jack and the corner of the trailer will drop somewhat. See Figure 48.

WARNING: Stand clear of the trailer when pressing on the quick-release lever for the trailer will drop when it is released. Do not lie under the trailer when releasing or lowering the stabilizers. Bodily injury could result due to the quick drop of the trailer if these warnings are not followed.

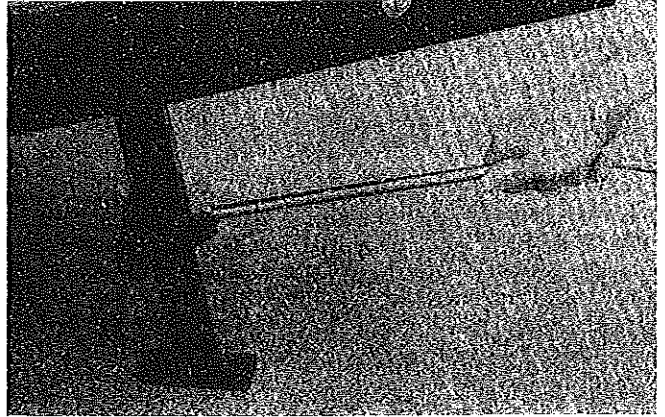

FIGURE 48

26. With the quick-release lever in the disengaged position, slide the inner stabilizer leg up into the stabilizer jack until it locks in position.
27. Grasp the stabilizer jack, pull down and push up toward the center of the trailer into its horizontal travel position. Jiggle and pull back the stabilizer jack to insure it is up and locked into position.
28. Perform steps 25, 26, and 27 for the other stabilizer jack/s and then stow stabilizer jack handle.
29. Rotate the crank handle clockwise slightly to release the tension on the crank lock. Disengage the crank lock (by pulling outward) and turn the crank handle counterclockwise to allow the top to be lowered. See Figure 5.
30. Rotate the crankshaft handle in a counterclockwise motion and lower the top to within one foot of the trailer. (Engage the crank lock to hold the top.)

WARNING: Keep a constant inward pressure on the crank handle to prevent the handle from backing off the crankshaft. When lowering the top **DO NOT RELEASE THE CRANK HANDLE** without engaging the crank lock. Bodily injury could result if the crank handle is released or backs off the crankshaft when raising or lowering the top.

31. Tuck in any tent fabric which may have worked its way out between the rooftop and trailer. This is important because if the tent fabric is pinched between the top and the aluminum rail it can become worn or discolored. Disengage the crank lock and continue to lower the top to the closed position.

IMPORTANT: If the top will not seat properly onto the trailer, **DO NOT** force it. Raise the top to approximately one foot and recheck tent distribution.

32. Stow the crank handle and the stabilizer handle, lock the access door and latch the four top latches.
33. Adjust the tongue jack so that the trailer tongue is higher than the vehicle hitch ball.
34. Back the vehicle close to the trailer and set brake.
35. Using the tongue jack, lower the trailer tongue onto the ball hitch of the vehicle. Engage the coupler release handle by pressing down into the locked position. The coupler has a hole in it for a safety clip or padlock to be inserted for trailer theft protection.

36. Retract the tongue jack wheel fully by turning the handle counterclockwise until it stops. Pull the release pin and swing the tongue jack up to the travel position. Bring the tongue jack handle up and over the tongue jack to store.
37. Attach the safety chains so they "crisscross" under the ball.
38. Connect the four-prong or six-prong pigtail to the mate.

NOTE: Always be sure to disconnect the white two-prong interior light pigtail.

39. Check to see that all running lights on the trailer are functioning properly.

SYSTEMS AND SPECIAL FEATURES

TRAILER L.P. GAS SYSTEM

Liquid propane gas is used in your trailer for three basic reasons: it is inexpensive, portable, and burns with intense heat. This system has been checked at our factory and by your dealer to insure its safety. Except for the simplest maintenance, this system should be checked by an authorized L.P. gas supplier should any problems develop. Due to the importance of this system and the safety precautions built into it, we feel it best to take a little time to describe it to you.

A. Gas Bottle

The L.P. gas is stored under pressure in the gas bottle located on the tongue of your trailer. This bottle should be kept free of rust at all times. If rust should develop on the bottle, the area should be cleaned completely of the rust, primed, and repainted white. Quite naturally, the service valve on top of the tank should always be closed when the tank is not in operational use, and especially when in transit.

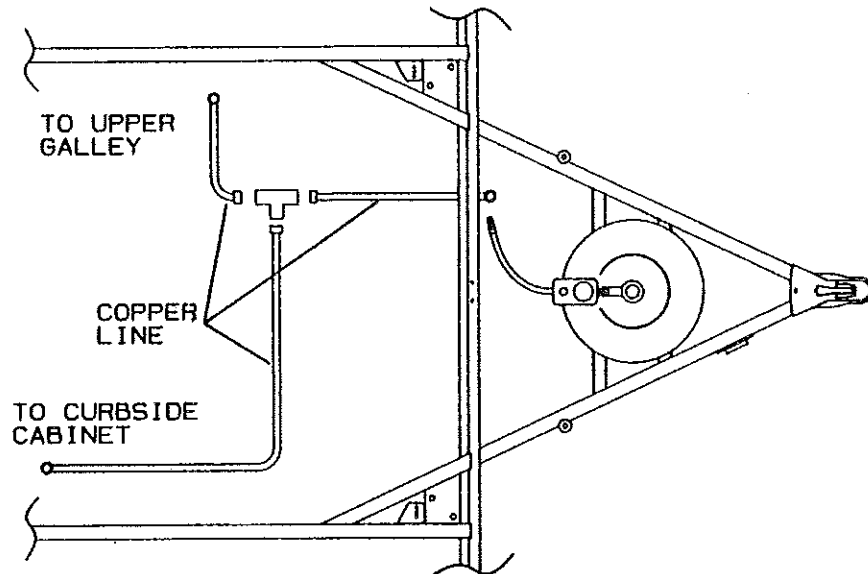

In order to change an L.P. gas bottle, follow these eight steps:

WARNING:

Do not smoke while changing the L.P. gas bottle and extinguish all surrounding open flames to avoid the possibility of fire and/or explosion.

NOTE:

Position L.P. tank with safety valve pointing away from trailer. Additional fittings are required as appliances are added i.e., water heater, furnace, refrigerator.

1. Turn off the L.P. gas at the burners. Be sure to check all burners.
2. Close the valve on the L.P. gas bottle by turning it in a clockwise direction.
3. Disconnect the regulator to the L.P. gas bottle, using a suitable wrench.

NOTE:

Regulator threads are left-hand threads. Turn clockwise to loosen.

4. Loosen the wing nuts from the J-bolts and remove the empty gas bottle.
5. Carefully place the full L.P. gas bottle on the tongue support and secure with the J-bolts and wing nuts loosened in Step 4.
6. Using a suitable wrench, attach the regulator (with the vent facing down) to the L.P. gas bottle.

NOTE: Regulator threads are lefthand threads. Turn counterclockwise to tighten.

7. Open the valve by turning it in a counterclockwise direction slowly.
8. Check for leaks by using a soap suds solution on all gas system fittings. We suggest that all gas system fittings in the trailer be checked for leaks with a soapy solution each time a gas bottle has been changed, every 30 days, or after the trailer has tracked over rough terrain. If the soapy solution is used and a leak is indicated by bubbles at a connection, tighten that particular connection sufficiently to stop the leak. If bubbles persist, close the L.P. gas bottle valve and contact your Fleetwood folding trailer dealer or L.P. gas supplier for assistance.

CAUTION:

Do not check copper and brass plumbing lines and fittings for leaks using ammoniated or chlorinated household type detergents. These can cause cracks to form on the line and brass fittings.

If a leak is suspect in the trailer, you will notice that L.P. gas has a distinctive odor. Should this be encountered, follow these directions:

1. Open the door and exit the unit, leaving the door open.
2. Close the valve on the L.P. gas bottle.
3. Do not touch electrical switches.
4. Extinguish any open flame.
5. Allow the trailer to ventilate thoroughly.
6. Check all stove valves to insure they are in the "off" position.
7. Check all pilot lights to make certain they are burning.
8. Check system for leaks by following steps outlined in Item 8 above.

B. Gas Bottle Regulator

The gas bottle regulator is the heart of your L.P. gas system. It is an automatic device with working parts which move continuously. Consequently, it requires more care, protection, and attention than any other part of the system. The basic function of the regulator is to take a high and varied inlet pressure from the gas cylinder and reduce it to a safe and consistent low outlet pressure to the gas appliances. Whatever the pressure is in the gas bottle, and it will vary due to atmospheric conditions, the regulator's job is to reduce it to 6.35 ounces or 11" water column outlet pressure, and supply fuel downstream at this pressure in whatever volume is required to efficiently operate each appliance as the demand is made.

The regulator is equipped with a vent because it is constantly "breathing." That is, the diaphragm of the regulator moves down and draws air into the bonnet or adjustment spring housing. When the diaphragm moves up, the air is expelled through the vent. In the event that excess pressure builds up in the lower housing or body of the regulator, a relief mechanism vents it to the atmosphere. It is imperative, therefore, to check the vent frequently to be sure it is clean and free of water, corrosion, or obstructions as clogging is the most common cause of regulator malfunction. If the vent does become clogged, it can easily be cleaned with a toothbrush. In addition, your

regulator should be checked periodically by a competent L.P. serviceman to be sure that it is properly adjusted and in safe working condition. By following these simple precautions, your regulator will give you years of trouble-free service.

WARNING:

If the regulator vent becomes plugged, excessive pressure will cause the appliance to leak, making fire and/or explosion possible and causing subsequent damage to the appliance.

C. How Should the Regulator Be Mounted?

The regulator will function regardless of the position in which it is mounted; however, the recommended mounting position is with the vent vertically down or in a direct line opposite the inlet. If for any reason this is not possible, bear in mind that it is extremely important that the vent be pointed in a direction which results in the least likelihood of dirt, water, or other foreign materials getting into the regulator. It is also important to install the regulator in a position in which the cover cannot possibly become a receptacle for water or other foreign materials.

D. What is Freeze-Up?

A regulator does not freeze, nor will L.P. gas; however, as the gas passes through the regulator, it expands and cools, and moisture in the gas or in the regulator will turn into ice. This ice can build up and totally or partially block the orifice and thus partially or totally block the fuel supply. There are a number of things you can do to prevent this type of freeze-up:

1. Before it is filled, Be sure the L.P. cylinder is totally free of moisture by drying any visible water around the valve area.
2. Be sure the cylinder is not overfilled. Insist that the bottle never be filled beyond 80% liquid level.
3. Keep the valves on an empty cylinder closed.
4. Have your L.P. dealer purge the cylinder if freeze-up occurs.
5. If necessary, have your L.P. dealer inject methyl alcohol in the cylinder.
6. Keep the cylinder in an upright position.

- E. If a gas bottle is overfilled, a built-in pressure mechanism on the bottle will allow excess gas to escape. It is imperative, therefore, that once bottles have been filled that they always be stored outdoors in an upright position whereby complete ventilation is possible. As an example, if a bottle is filled during extremely low temperatures, an increase in temperature will allow the gas to expand and possibly trigger the release valve. The presence of this gas in a confined area could result in fire or explosion caused by exposure to an open flame.

WARNING:

The water heater and furnace combustion air exhaust ports may be extremely hot during water heater and furnace operation. Do not touch these outlets or allow any material to come in contact with, or cover, either the air intakes or exhaust ports while operating the water heater and/or furnace.

NOTE:

Preventative maintenance on all gas appliances should include periodically cleaning as needed to remove dust, lint, ect. from burner tubes and air passages.

Burner tubes and orifices should also be inspected frequently for obstructions such as insects/spider webs or other foreign matter that may cause a burner malfunction.

For further details refer to respective appliance manual.

TRAILER ELECTRICAL SYSTEM

The electrical system of your camper is broken down into two separate and distinct functions - the 12 volt direct current and 115 volt alternating current. The 115 VAC is used solely for the operation of interior 115 VAC receptacles. The 12 VDC is used for all other functions including interior lights and the operation of 12 VDC appliances (i.e., furnace). By using the power converter, 115 VAC is converted to 12 VDC for the operation of interior lights and optional furnace.

A. 12 Volt Vehicular Electrical Circuit

The 12 volt DC electrical circuit is dependent on the tow vehicle's battery or an extra battery. Frequent and regular checks of the vehicle battery should be made to assure electrical system stability. We suggest the following checks:

1. Battery terminals and posts free from corrosion.
2. Battery terminals securely fastened to the battery posts.
3. Battery water level.
4. Battery voltage at the level specified by the vehicle manufacture.

Before each trip, make an operational check of all DC electrical functions of the trailer: turn, stop, side marker, and taillights. If a bulb does not light, remove the lens cover from over the bulb not functioning. Most often, bulb replacement will cure the malfunction; however, should the malfunction persist, secure the aid of a voltmeter and the wiring diagram contained herein and check the DC voltage and/or continuity of the circuit. Repair or replace as required.

B. 115 Volt AC Power Supply

The 115 volt AC power cord is located under the roadside dinette seat. This power cord can be plugged into a park supply power source for the operation of interior receptacles only. The converter will change the 115 volt AC park supply to 12 volt DC current for interior lighting and optional furnace operation. Please refer to "Set-up Instructions, Electrical and Water Hook-ups" for additional operation and use of the power converter.

WIRING DIAGRAM - (ROANOKE & CEDAR)

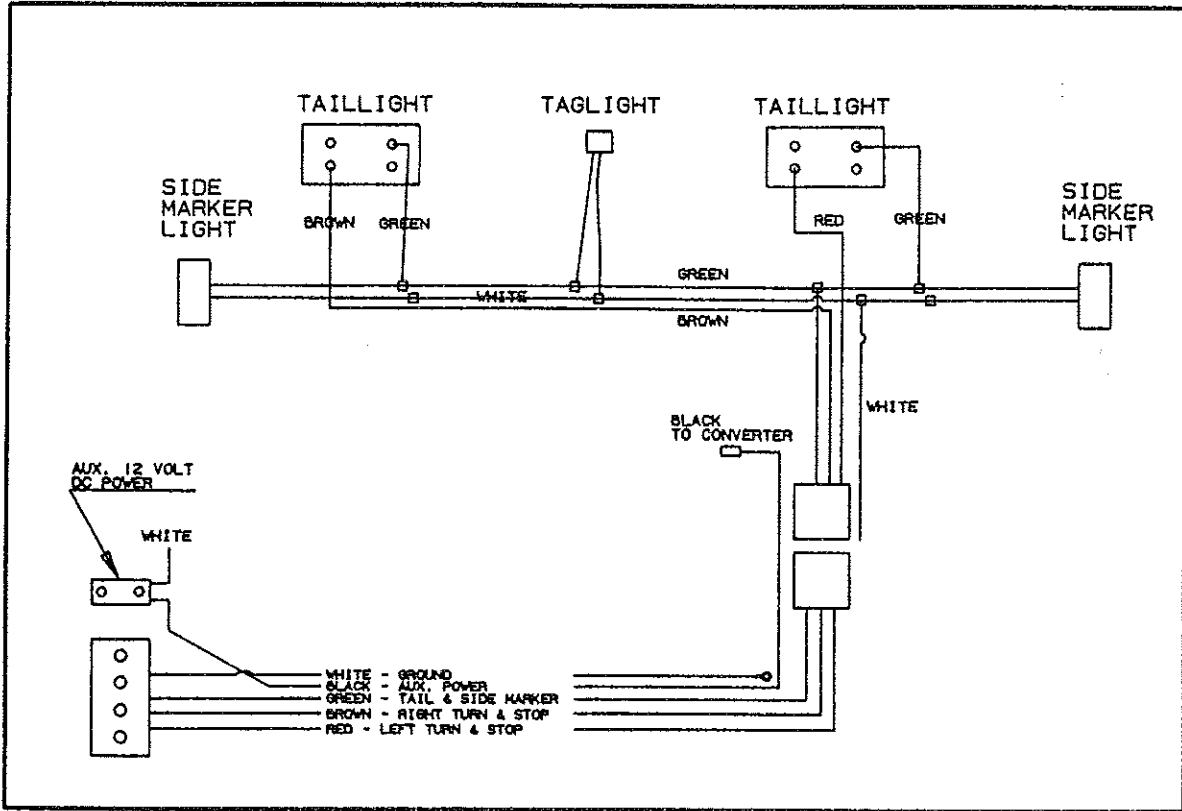

WIRED

WIRING DIAGRAM - (ROYALE AND RIO GRANDE)

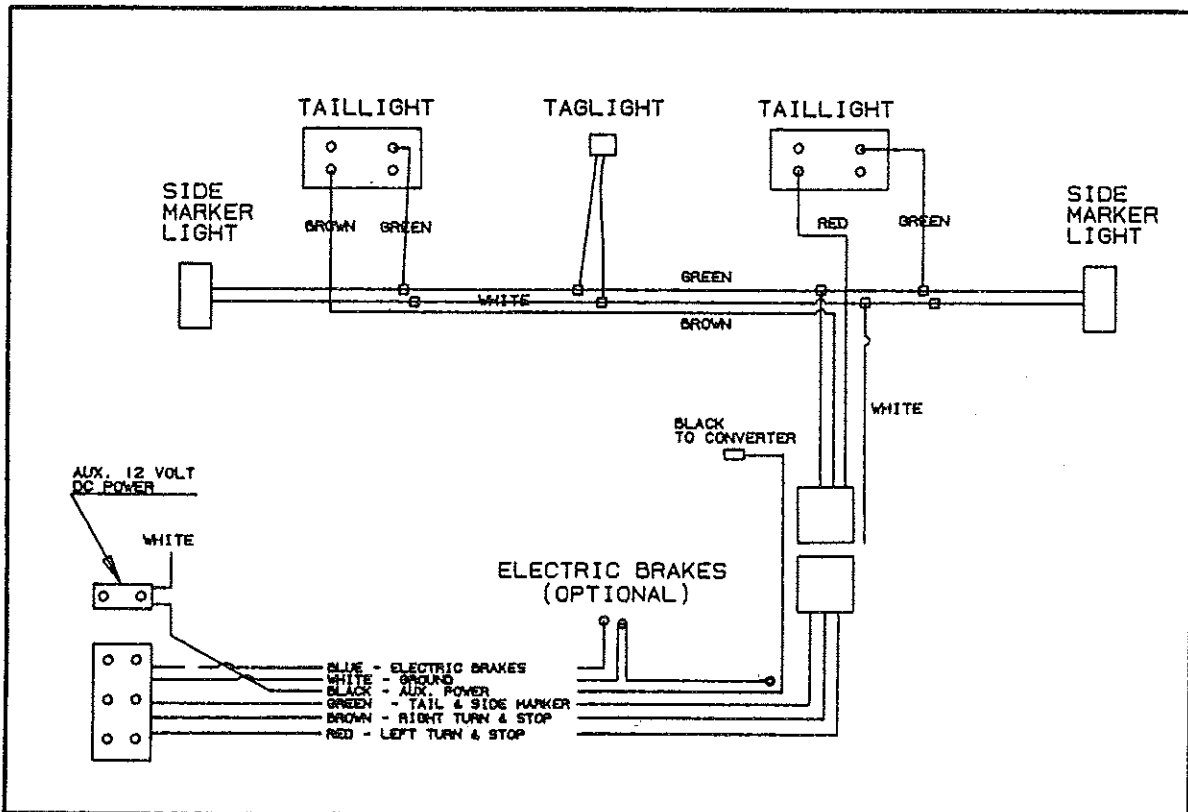

WIRED

WATER SYSTEM

Fresh water may be supplied to your trailer sink from one of two sources - the water tank or the city water hookup.

A. Water Tank System

To insure complete sanitation of the five-gallon water system, we suggest the following procedure be used on a new system, one that has not been used for a period of time, or one that has become contaminated.

1. Prepare a chlorine solution using 1/2 gallon of water and 1/8 cup of Clorox or Purex household bleach (5% sodium hypochlorite solution).
2. Pour 1/2 gallon of solution into tank.
3. Complete filling of tank with fresh water.
4. Open the faucet until all air has been released from the pipes and entire system is filled. Pump water up to the sink.
5. Allow to stand for three hours.
6. Drain and flush with potable fresh water.
7. To remove any excessive chlorine taste or odor which may remain, prepare a solution of one quart vinegar to five gallons water and allow solution to agitate in the tank for several days by vehicle motion.
8. Drain tank and again flush with potable water.

Once the internal water system has been cleaned, flushed, and refilled, water can be pumped by raising and lowering the pump handle. When using the city water supply, depress the pump handle which will allow city water to flow freely

Continual city water flow can be obtained by rotating the hold-down rod over top of the pump handle as shown in Figure 49 and Figure 50. This will allow for both hands to be free for kitchen type chores such as washing dirty dishes.

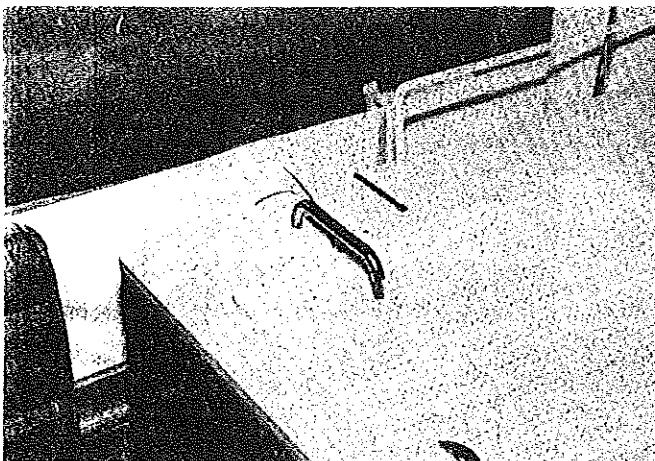

FIGURE 49

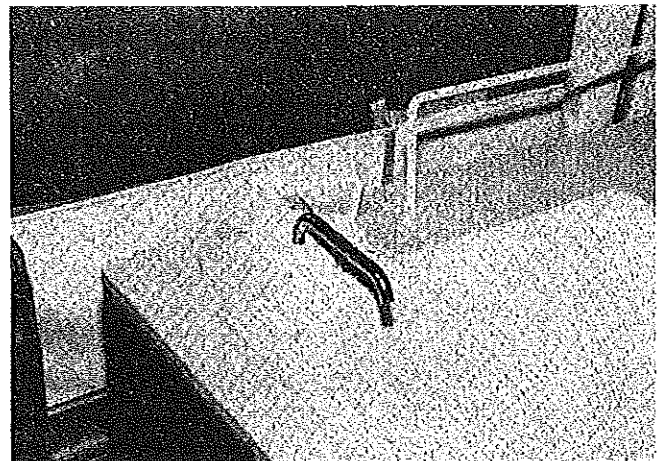

FIGURE 50

B. Sink Drain

The outlet port for the sink drain is located on the same side of the trailer as the sink and the location is identified with a "drain" decal affixed to the body panel. The sink can be drained by simply removing the plastic protective cap from this fitting and allowing the water to flow freely from the sink.

TRACKING SYSTEM

A. Tires

CAUTION:

To provide maximum towing ease, tire life, and trailering safety, check the following items before each trip to and from the campsite:

1. Tires inflated to recommended pressure as indicated on the tire sidewall.
2. Wheel lug nuts securely tightened (70-80 footpounds for 8" tires; 80-90 footpounds for 12" tires).
3. A visual inspection of tire tread and walls for wear or cuts.
4. Trailer is being towed as level as possible.

Please Note:

The tires on the Fleetwood folding trailer are warranted separately by the manufacturer. While the warranties of the various tire manufacturers vary in language, they in general provide that tires installed as original equipment at the factory are warranted to the owner to be free from defects in material and workmanship for the life of the tire tread. There is no warranty coverage for damages resulting from road hazards, etc.

If a tire warranty adjustment is required, the trailer owner should contact the nearest authorized representative of the tire manufacturer. In the event there is no local representative, the customer should follow the directions set forth in the tire warranty card packaged in each folding trailer or call DURO, toll free number 800-966-TIRE. A Fleetwood folding trailer dealer MAY be able to assist you in locating the tire manufacturer's local representative who can handle warranty adjustments. Requests for tire warranty adjustments **should not** be sent to Fleetwood Folding Trailers, Inc.

NOTE:

NOT all Fleetwood folding trailers are capable of accepting different size tires. Prior to making any tire size changes, consult your dealer for tire size adaptability.

B. How to Change a Flat Tire

Tires may be easily changed in the following manner:

1. When possible, locate the trailer on level terrain and remove from the tow vehicle.
2. Block both front and back side of the tire opposite the one needing changing.
3. Using the tongue jack, lower tongue end down as far as the tongue jack will allow.

4. Remove the hubcap from the tire you wish to change.
5. Using a 13/16" lug wrench, break loose the lug nuts.
6. Pull down rear stabilizer jacks, extend the stabilizer jack to near full extension on the side which will be changed. Extend the stabilizer jack on the side of the inflated tire just to the ground.
7. Rotate the tongue jack handle in a clockwise motion and raise tongue end up. Stop when tire to be changed is raised approximately 3/4" off the ground.
8. Take the lug nuts off using the lug wrench.
9. Slide the flat tire off and slide repaired, new or spare tire on to axle.
10. Start each lug nut by hand to avoid cross-threading and then use the lug wrench to draw the lug nuts reasonably tight.
11. Lower the tongue jack until the tire is on the ground. Using a lug wrench, draw the lug nuts tight (70-80 footpounds for 8"; 80-90 footpounds for 12"). See chart for proper sequence of torquing lug nuts.
12. Replace hubcap. w/applicable
13. Release the stabilizer jacks and return to travel position.

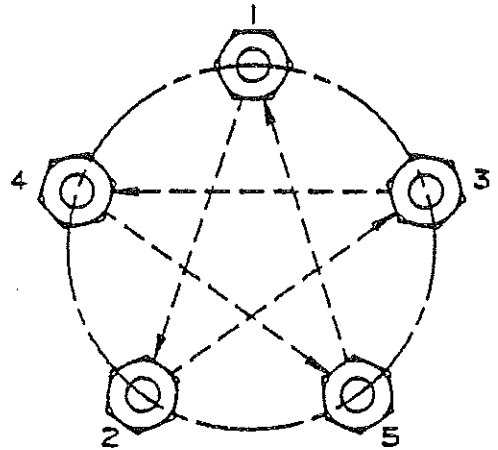

CAUTION:

After you have driven a short distance (approximately one or two miles), stop and recheck the lug nuts to insure they are securely tightened. Check again after 25 miles.

C. Brakes (Option with Royale/Rio Grande Only)

Brakes should be adjusted after the first 200 miles and at 3,000 mile intervals, or as use and performance requires. The brakes should be adjusted in the following manner:

1. Jack up one wheel and check that it rotates freely.
2. Remove the adjusting hole cover from the adjusting slot on the bottom of the backing plate.
3. With a screwdriver or a standard adjusting tool, rotate the star-wheel of the adjusting link by moving tool "down" to expand and tighten the brake shoes. Adjust shoes out until the pressure of the linings against the drum makes the wheel very difficult to turn.
4. Now, rotate the star-wheel in the opposite direction by moving tool up until wheel turns freely.
5. Replace adjusting hole cover and lower the wheel to the ground.
6. Repeat the above procedure for the other brakes.

CAUTION:

Never crawl under the trailer while it is resting on trailer jacks.

Foregoing the "wearing in" procedural adjustments, the electric brakes need to be checked and adjusted as required, once a year.

NOTE:

Periodic brake adjustment is the consumers responsibility.

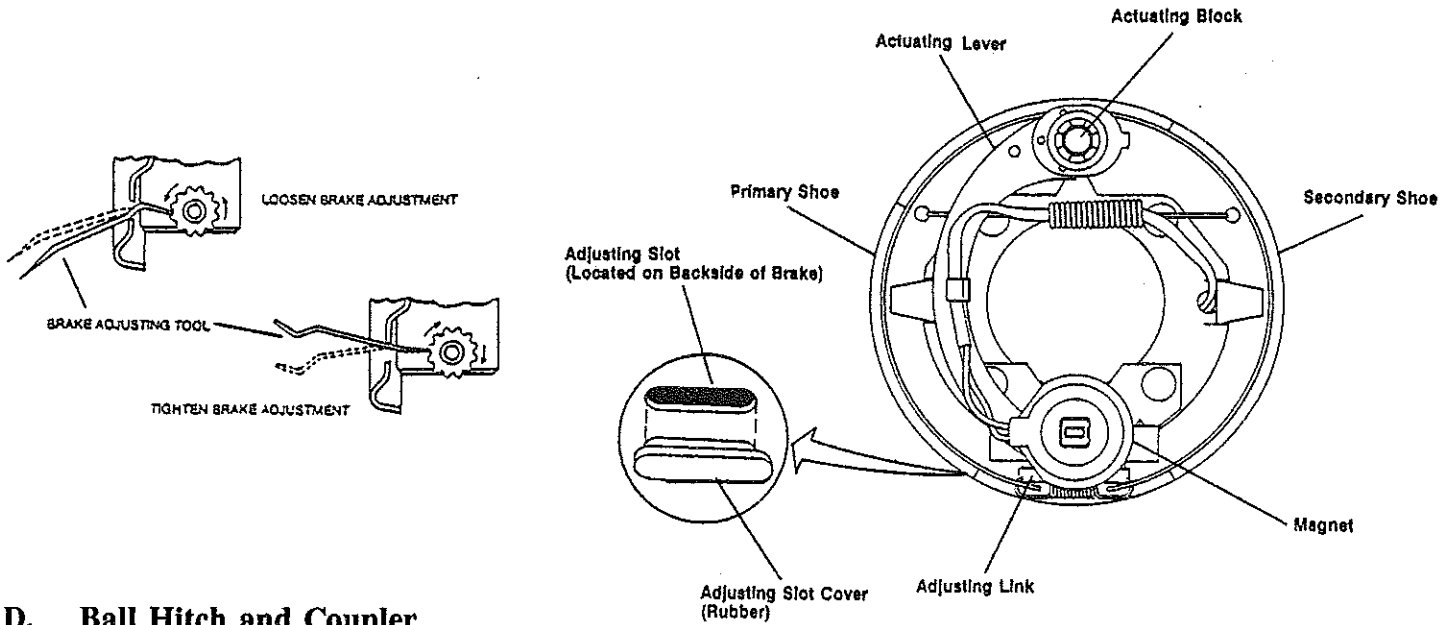

D. Ball Hitch and Coupler

Maintain a coat of light grease on the ball hitch of your vehicle. This will induce longer ball hitch life and towing ease.

The coupler should be adjusted, when required, to maintain the coupler/ball snugness. With the coupler attached to the ball and the coupler release handle down in the locked position, adjust the lock nut (on the underside of the coupler) to compress spring to within 1/32" of solid. See adjacent figure.

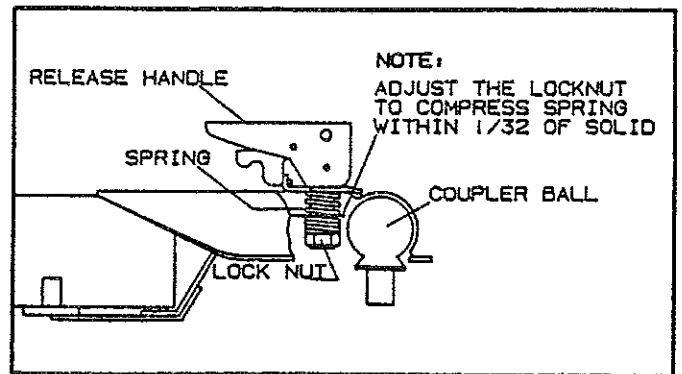

Make a visual inspection of the safety chains for damaged or corroded links; repair or replace as required. Insure the ball hitch is securely attached to the vehicle and the ball head is securely tightened.

E. Recommended Practices for Lubricating and Adjusting Wheel Bearings

IMPORTANT:

Wheel bearings should be checked before the initial camping trip and then every 2,000 miles or twice a season, whichever occurs first, and at the beginning of each camping season.

1. Lubrication

Proper lubrication is essential to all types of bearing application. The kind of lubricant used is governed by the design and operating conditions. The function of lubricants is mainly to:

- a. Reduce friction between moving parts.
- b. Carry away heat.
- c. Aid the seal in keeping lubricant in its place and keeping foreign matter out of the bearing.

Bearings will run the coolest and with the least friction when a minimum amount of the lightest bodied lubricant that will keep bearing surfaces apart is used. Heat in bearings is due to a number of causes such as: (a) too much lubricant, (b) too heavy lubricant, (c) too tight adjustment.

We probably will always have with us the man who says, "If a little is good, a lot is better." This is as great a fallacy in bearing lubrication as it is in medicine or anything else. If too much or too heavy a lubricant is used, there is bound to be an increase in temperature when the wheel starts to rotate, usually followed by leakage. An attempt to stop this by tightening the adjusting nut will increase the friction, thus still aggravating the condition until, in extreme cases, the bearing fails.

We know that our bearings have to function under high temperatures due to the electric brake heat, so we have chosen lubricants of such character that they will return to their original consistency when the bearing cools, with practically no oil separation. We use and recommend the following grease or its equivalent: Wolfhead high temperature wheel bearing grease.

The manufacturing company recommends that wheel bearings be inspected and repacked every 2,000 miles or as required and at the start of every vacation season. A trailer sitting idle for a few months will collect some moisture in the hubs due to atmospheric conditions and this is the reason for inspecting and repacking the bearings at this time.

The relubrication of wheel bearings is possibly the most important service performed to the running gear. The two most important phases of this operation are cleanliness and proper adjustment.

Before disassembly of the hub, check wheel play and freedom of rotation. Extreme or excess play indicates a too-loose adjustment or a defective bearing. Too much drag in rotation of the hub could indicate tightness in bearing adjustment or a brake being adjusted too tight.

To begin disassembly, remove the dust cap. Next, remove the cotter pin and spindle nut. Jiggle the hub slightly to loosen the outer bearing. Usually the outer bearing will loosen up enough to be removed by hand. Pull the entire hub which contains the inner bearing and grease seal. Remove the inner bearing and grease seal by placing a brass drift or piece of wood through the small end of the hub and tapping gently until the bearing and seal is loose. Wipe all dirt and grease from the inside of the hub and the spindle.

Used bearings must be cleaned prior to relubrication. Various solvents are effective for degreasing. Successful processes employ kerosene, distillates, and chlorinated hydro-carbons. The solvent action of kerosene is limited, but it has the advantage of leaving a rust-inhibitive film on the bearing. After cleaning, bearings should be allowed to drain free of solvent which might dilute lubricants. Do not immerse the grease seal in any solvents, but wipe clean with a cloth.

WARNING:

Do not use above-described cleaning solvents near or around open flames as fire or explosion could occur resulting in serious bodily injury.

Carefully inspect cups (races) and cones (bearings) for pitting, scratches, excessive wear, or other damage. Do not replace a bearing unless you also replace its mating cup.

If at all possible, use a bearing packer to repack the cones. If this is not available, the bearings can be lubricated by hand if the grease is pressed into and around each and every roller. (See Figure 51). Additional grease within the hub is not required. Install the inner bearing in the hub and replace grease seal by tapping gently with a wooden block, (See Figure 52) making sure the seal is installed as it was before disassembly. Replace hub on spindle, taking care not to damage threads or grease seal. Replace outer bearing and spindle nut. Slowly rotate the hub in one direction or the other while tightening the spindle nut (maximum 50 footpounds torque) or until there is a slight bind to be sure that all bearing surfaces are in contact.

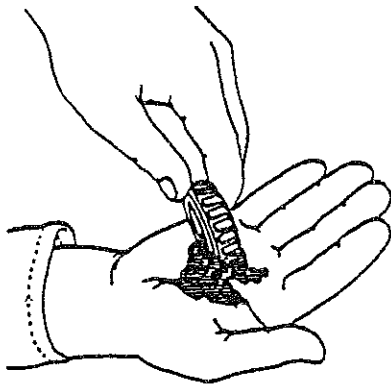

FIGURE 51

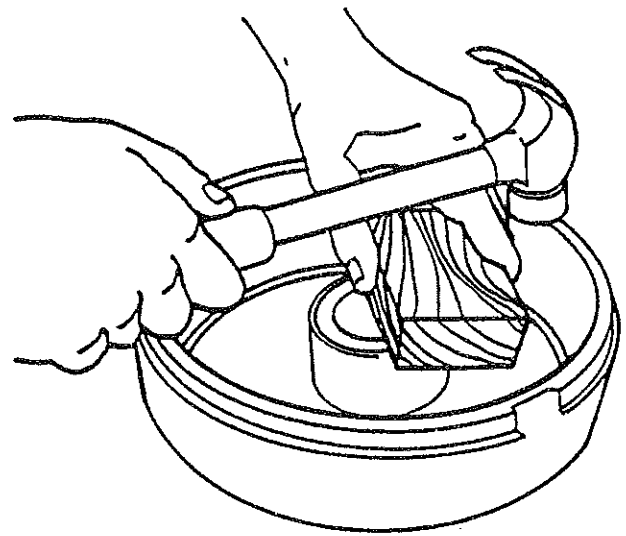

FIGURE 52

IMPORTANT:

At this point the adjusting nut is backed off $1/6$ to $1/4$ turn or to the nearest locking hole or castellation. This will allow the wheel to rotate freely without excessive end play. The total amount of internal running clearance between the roller and the raceways of the bearings should be within $2/1000$ to $8/1000$ recommended limits. This can only be measured accurately with the use of special instruments, but by simply pushing inward and pulling outward on the hub several times a person should feel a very slight end play. If the bearings are too tight or too loose, they will fail prematurely. Install new cotter pin, bend to locked position, and drive on grease cap.

We wish to stress the point that the bearings used in the hubs of Folding Trailers are subjected to higher speeds and heavier loads than a few years ago. For that reason, they must be maintained more frequently than before. We feel certain that maximum bearing life and performance will be consistently obtained if the methods of lubrication and adjustment we have described are followed.

LIFT SYSTEM

The lift system in your new Fleetwood folding trailer is a well designed, virtually trouble-free system if used properly and within the guidelines set forth in this owner's manual. Twenty years of engineering design and improvements have gone into this system. Although this system has remained basically the same since we have been manufacturing folding trailers, we have improved the design, efficiency, and material quality. For example, the four lift assemblies on your camper are manufactured from high-quality stainless steel. The four long cable assemblies extending from the main screw shaft to each lifter are stainless steel in order to offset the severe road conditions of salt, chemicals, dirt, and so forth. The pulleys used in the lift system are all steel pulleys with steel needle-bearing inserts for long life and dependability. Contained within this section, therefore, are some hints and tips relative to the proper care of your lift system.

- A. Never crank the trailer up with added weight on the roof except for a dealer-installed air conditioning unit. Additional weight placed on the top assembly while the unit is being cranked up can result in an unnecessary strain on the lift system causing cables to be stretched and the loss of proper height adjustment and/or irreversible lift damage. Never raise or lower the roof with the stabilizer jacks set. This action can cause a bind on the trailer frame resulting in excessive pressure being placed on the four lift assemblies.

B. **Maintenance**

The only maintenance that will be necessary to perform to your lift system is an occasional lubrication of the pulleys contained within the lifts. This lubrication should be only a silicone spray and used very sparingly.

NOTE:

Excessive lubrication on the pulleys and lift arms can result in unsightly stains to the tent enclosure.

C. **Top Adjustment**

Height adjustment, if necessary, can be performed at each main cable adjustable pulley bracket. One bracket is located in each corner of the main frame tube area. Adjustments should be made as follows:

1. Crank top to approximately 12" high.
2. Extend front and rear bed assemblies approximately one foot past body rails.
3. Lower top down on extended beds until crank stops to relax cables.
4. Remove pulley pin and relocate pulley to an alternate hole position. (Each hole should add about 1 1/2" to that particular corner or a maximum of 3" adjustment available at each corner. Do not overadjust or canvas and weatherseals may be damaged.)
5. Raise top and return beds to travel position.

Left Front Corner

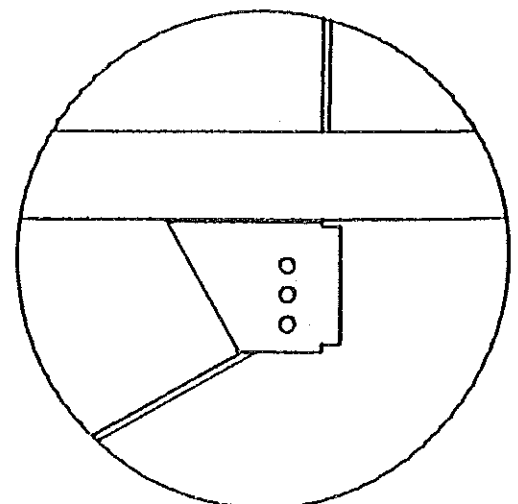

NOTE:

Fine adjustments can only be performed at the main drive train area. This adjustment should be performed by an authorized Coleman dealer.

IMPORTANT:

We emphasize that any customer repairs to the lift system should only be done as a temporary measure. Your dealer should be consulted prior to performing any lift system service to prevent inadvertent damage to the system.

TENT ENCLOSURES

A. Care and Repair of Evolution 3 Tent Fabric

The tent enclosure on your unit is Evolution 3 fabric. This newly designed material is a strong, three-layer polypropylene laminate which will resist common stains, soil, mildew, and rot. The procedures set forth may be used to correct soiling or spot fabric leaking caused by accidental contact with insect repellents and sprays. Products containing surfactant e.g., insect repellents, suntan oils, can cause a loss of water repellency. This can easily be corrected by following the washing instructions outlined below:

1. Concentrated Leaking Areas of Evolution 3

Light brushing with a soft cloth will remove most dirt. For persistent soils:

- a. Wet soiled fabric with water.
- b. Wash with Surf detergent or Joy liquid. Dilute 1/4 cup cleaner per two gallons of water. Work into a lather with a sponge; lightly work the lather into the soiled area.
- c. Rinse thoroughly with copious amounts of water to remove all soap residue. Soap residue can cause fabric leakage.
- d. Air dry completely.

2. Severe Leaking of Entire Evolution 3 Section

- a. Remove entire contaminated section of Evolution 3.
- b. Take contaminated section to a laundromat capable of handling carpet and large rugs.
- c. Using 1/2 to 3/4 cup of Surf detergent or Joy liquid; wash sections of contaminated Evolution 3 through normal wash/rinse cycle.
- d. Allow washed section to air dry on trailer.

NOTE:

All washing of leaking Evolution 3 material is the consumer's responsibility and is not covered under normal warranty procedure. If the above procedures do not correct the leak, contact your nearest authorized Fleetwood folding trailer dealer for assistance.

If slight fabric leaking persists due to presence of soap residue, the area may be treated with a water repellent such as 3M Scotch Guard Fabric Protector. If slight fabric leaking exists at any seam, simply coat the affected seam with a small amount of K Kote seam sealer, available at your local K Mart or hardware store.

Accidental rips and tears in Evolution 3 tent fabric can be easily repaired by sewing or by stitch-patching with Evolution 3 fabric. When stitch-repairing, treat all stitching with a seam sealer such as K Kote Seam Sealer. Also recommended as an added treatment for stitching repairs are Shoe Goo and Kiwi Shoe Repair (available at K Mart, department, hardware, and sporting goods stores).

NOTE:

Heat applied patches should not be used on Evolution 3 material. Concentrated excessive heat such as that produced by a clothes iron will damage the Evolution fabric.

Condensation:

The relatively small volume and compact construction of a modern recreational vehicle mean that the normal living activities of even a few occupants will lead to rapid moisture saturation of the air contained in the trailer and the appearance of visible moisture, especially in cold weather.

The air inside a recreational vehicle can contain a surprisingly large amount of water vapor. Estimates indicate that a family of four can vaporize up to three gallons of water daily through breathing, cooking, bathing, and washing. Unless this water vapor is carried outside by ventilation, it will condense on the inside of the tent enclosure as moisture.

If you know the signs of excessive moisture and condensation, you can minimize their effects during cold weather by the following:

1. Ventilate with outside air. Partially open one or more windows to provide controlled circulation of outside air into the interior. While this ventilation will increase furnace heating load, it will greatly reduce or eliminate water condensation. Even when it is raining or snowing, ventilation air from outside will be far drier than interior air and will effectively reduce condensation.
2. Provide more ventilation while cooking is being done inside the camper.
3. Insure adequate ventilation in areas where condensation problems are experienced.
4. The use of an electric circulating fan or a small dehumidifier inside the camper will noticeably reduce condensation.
5. An application of Rain Check or Camp Dry to the external tent enclosure provides a secondary moisture barrier.

NOTE:

Even when it is raining or snowing, ventilation air from outside will be far drier than interior air and will effectively reduce condensation.

B. Vinyl Bed End Covers

The vinyl over the bed areas can be cleaned by using cool water and a soft bristle brush or cloth. Rinse thoroughly with cool water and allow to dry. When necessary, automobile convertible top cleaners can be used to remove stains. Care should be taken not to allow the vinyl cleaner to come in contact with the Evolution material. Cleaning agent residue left on Evolution material can cause leakage.

IMPORTANT:

Follow the manufacturer's instructions carefully for use of such cleaners or damage to the vinyl surface could occur.

CAUTION:

The use of insect repellents, hairsprays, and deodorants inside the camper when sprayed on the tent surfaces will cause a breakdown of the water repellency of the fabric. We suggest, therefore, the very limited use of such sprays inside the unit during camping as damage to the tent enclosure could result.

The zippers on your tent can be lubricated by using a paraffin wax. The use of paraffin on the zippers will enhance their ease of operation around the tent sections and windows.

MISCELLANEOUS STANDARD FEATURES

A. Front Trunk Storage - (Rio Grande model only)

The Rio Grande model is equipped with a front trunk storage area to enable you to carry those extra needed items on your camping trip.

1. To access the trunk area unlock the top latches. See Figure 53.

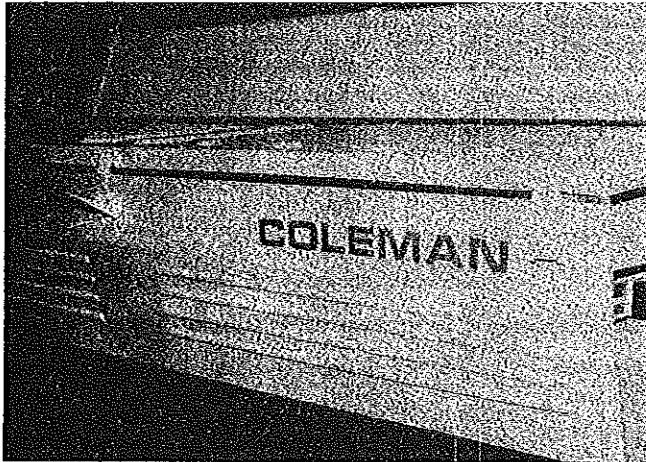

FIGURE 53

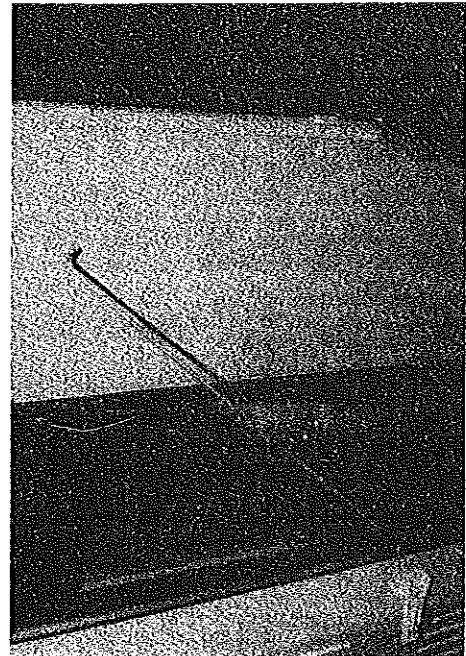

FIGURE 54

2. Lift trunk storage lid. Remove prop rod from retaining brackets located along front rail. Insert free end of prop rod into retainer on trunk lid to hold in the open position. See Figure 54.
3. Side access to the storage area can be obtained by opening the side access doors on either side of the trailer. Insert key and turn 90 degrees clockwise to open. See Figure 55.
4. Interior lighting is provided inside the storage area to allow visibility in low lighting situation such as evening arrival to campgrounds for set-up.

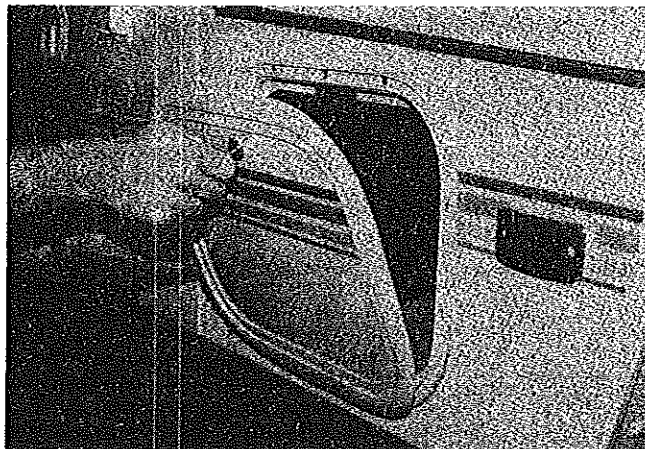

FIGURE 55

MAINTENANCE

COMPONENT	IDENTIFICATION	STANDARD CARE	FREQUENCY	AVOID
Appliances				
Stove		Appropriate household cleaners	As needed	Abrasive cleaners
Sink		Appropriate household cleaners	As needed	Abrasive cleaners
Countertops		Clean with warm, soapy water	As needed	Abrasive cleaners
Axle	51" spring center 64" track	U-bolts torqued to 15 - 17 footpounds	Once/season	Road hazards and overloading
Backrest and Cushion covers	Herculon/Olefin	Vacuum; foam-type cleaners	As needed	Grease, oil, excessive heat
Bearings	Tapered roller	Lubrication See "Tracking System"	Every 2,000 and before each season	Road hazards and overloading
Bed Slides	Aluminum	Use only silicone lubricant	As needed	Unsupported beds, excessive lubrication
Canopy		Vinyl cleaner	As needed	Storing wet for extended periods
City Water Fill		Cover when not in use	Always	Overtightening
Converter	Magna-Tec	Use of proper fuses as noted on converter		Overloading and to repair; sealed unit
Cooler	Coleman	Clean with mild soap and water	As needed	
Coupler	Fulton 1 7/8"	Wheel bearing grease on release lever and socket, proper adjust- ment; See "Tracking System"	Once per year	Improper adjustment
Dome Light	1.5 amps	Re-lamp only with bulb noted on fixture base	As needed	Lights on when unit is closed; operating in 12 VDC mode
Drain		Winterize by draining sink and all water lines	As needed	Moving w/o discon- necting utility lines
Drapes		Hand washable; mild detergent; drip dry	As needed	Machine washing; storing wet
Evol III		See "Tent Enclosure"		
Exterior Finish				
Stucco Embossed		Wash with water and apply quality auto wax	As needed	Abrasive cleaners; waxing in the hot sun
ABS Panel	ABS plastic	Mild soapy water and wax	As needed	
Fire Extinguisher		Check for charge prior to each camping trip; note directions on unit		

MAINTENANCE

COMPONENT	IDENTIFICATION	STANDARD CARE	FREQUENCY	AVOID
Floor Covering	Armstrong	Clean with water and mild soap	As needed	Abrasive cleaners
Frame	Painted steel	Hose regularly to prevent build up of contaminants; remove surface rust and repaint as needed	As needed	Chemical contact
Furnace	Hydro Flame	See furnace manual		
Gas Bottle		See "Gas System"		
Gas Hose	Rubber	See "Gas System"		
Gas Line	Copper	See "Gas System"		
Lift Assemblies	Stainless steel	See "Lift System"		
Lug Nuts	13/16"	70-80 Footpounds for 8" 80-90 Footpounds for 12"	Before each trip	
Mattress Covers	Herculon/Olefin	Vacuum; foam-type cleaners	As needed	Grease, oil, excessive heat
Pigtail	Six-wire - Royale/ Rio Grande Four-wire - Roanoke/Cedar	Inspect for cuts, breaks, or dirt	Prior to each use	Cutting, dirt
Pulleys		See "Lift System"		
Water Pump Faucet		Lubricate pump lever with mineral oil	Once a year	Freezing with water in line
Screen Door	Aluminum	Wash with water and apply quality auto wax	As needed	Abrasive cleaners
Stabilizer	Atwood (650 lbs)	Keep free of dirt; lubricate with silicone	As needed	Dirt buildup
Table	5/8" Particle board	Clean with damp cloth	As needed	Direct heat; excessive exposure to elements
Tires	Duro	See "Tracking System" section		Under- or over-inflation
Tongue Jack	Atwood (500 lbs.)	Position handle properly while traveling; lubricate with light oil	Once a year	Salt and chemical contact
Top Assembly Exterior	Aluminum sandwich panel	Wash as needed; inspect for voids in caulking	Check caulking once per season	Abrasive cleaners; excessive weight
Interior	Vinyl luan	Clean with water and mild soap solution	As needed	Abrasive and sharp instruments
Vinyl Windows	Clear vinyl	Warm water and mild detergent	As needed	Abrasives and storing wet

SPECIFICATIONS

Gross Axle Weight Rating (GAWR) - Weight carrying capacity of the axle while the trailer is in tow. (See certification label.)

Gross Vehicle Weight Rating (GVWR) - The maximum loaded weight the trailer can safely accommodate while in tow. (See certification label).

Cargo Weight - The weight of all additional goods placed in the camping trailer and placed on the trailer hitch while in tow.

Cargo weight or loading capacity can be computed for your model year trailer by securing the weight specification from the trailer certification label (located on the left body panel).

To calculate the cargo weight with FULL LP gas bottle and a FULL water tank, these weights must be deducted from the dry cargo weight.

Example:

GVWR 1,385 lbs.
 Trailer Weight (Dry) 995 lbs.
 (curb and hitch)
 Cargo Weight (Dry) 400 lbs.
 (no gas/water in tanks)

Example:

LP gas in bottle (1) 20 lbs.
 5 Gallons water 42 lbs.
 (8.345 lbs/gallon)
 Full tanks 62 lbs.
 Cargo weight dry 480 lbs.
 Less fluid weight 62 lbs.
 Actual cargo weight for transit 418 lbs.

To insure proper towing characteristics, cargo weight distribution should be as follows: 10% forward and 90% aft of the access door (not to exceed available cargo capacity) distributed evenly throughout the camper. **This information does not apply to the Rio Grande model.**

NOTE: Optional accessories added to the trailer must also be deducted from available cargo capacity.

	<u>Roanoke</u>	<u>Cedar</u>	<u>Royale</u>
Road Height	45"	45"	47"
Length Closed	11'5"	11'5"	13'5"
Length Open	17'	17'	21'
Width	6'8"	6'8"	6'8"
Interior Height	6'5"	6'5"	6'5"
LPG Tank (lbs)	20	20	20
Water Tank (gallons)	5	5	5
Tires Listed @ GVWR	5.70 x 8	5.70 x 8	5.30 x 12
Gross Axle Weight Rating (GAWR)	1,200	1,200	1,680
Gross Hitch Weight Rating (GHWR)	185	185	195
Gross Vehicle Weight Rating (GVWR)	1,385	1,385	1,875
Base Axle Weight	870	870	1,100
Base Hitch Weight	<u>125</u>	125	<u>125</u>
Base Vehicle Weight	995	995	1,225
Cargo Capacity			
Aft Door	330	330	580
Forward of Door	<u>60</u>	<u>60</u>	<u>70</u>
Total	390	390	650
Coupler Size	1 7/8"	1 7/8"	1 7/8"
(maximum vertical load 200 lbs, Class A, Type I)			

NOTE: FOR WEIGHT SPECIFICATIONS AND LOADING INSTRUCTIONS FOR THE RIO GRANDE MODEL, SEE SPECIFICATION LABEL LOCATED WITHIN THE TRAILER.

NOTE: Electrical System - 115 VAC, 15 AMP

Weights listed are subject to a 5% variation

Weights listed are less fluids and options.

Fleetwood Folding Trailers, Inc. reserves the right to change specifications at any time without notice or obligation.

LIMITED WARRANTY

1993 FLEETWOOD FOLDING TRAILER

1. Your new Fleetwood folding trailer is warranted to the original retail consumer to be free from defects in material and workmanship for one year from the date of retail purchase. This warranty is not transferrable.
- 2A. The lift system (used to raise and lower the roof) is warranted to the original retail consumer for his or her lifetime against functional defects in material and workmanship. This warranty covers both parts and labor with the following exclusions:
 - i. Normal adjustments to the lift system (such as periodic roof height adjustment to compensate for stretch in cables) are covered for the first year of this warranty only.
 - ii. The installation of a roof air conditioner and/or any other roof-mounted accessories and cargo cannot exceed 150 pounds. Exceeding this limit voids the warranty provision on the lift system.
 - iii. Any damage resulting from alterations to the lift system.
 - iv. Any damage caused by improper maintenance, improper repair, or by use of improper repair parts.
- 2B. The floor is warranted to the original retail consumer for his or her lifetime against functional defects in material and applies only to the structural integrity of the Structurwood. This warranty covers both parts and labor. The warranty on the vinyl floor covering is found in section 7.8 of this warranty.
- 2C. The bed wood is warranted to the original retail consumer for his or her lifetime against functional defects in material, and applies only to the structural integrity of the Structurwood. Parts and labor under this paragraph are covered for lifetime.

This warranty excludes all other bed components i.e. bed extensions, bed frames.
- 2D. The steel frame is warranted to the original retail consumer for five years against functional defects in material and workmanship. Both parts and labor under this paragraph are covered.

This five year provision does not include the frame surface finish, axle beam, springs, or running gear components.
- 2E. The roof of this folding trailer is warranted to the original retail consumer for five years from the date of retail purchase against functional defects in material and workmanship. Both parts and labor under this paragraph are covered.

This warranty provision does not include surface finish or damage due to the installation of non-standard equipment.
- 2F. The Evolution 3 tent material is warranted to the original retail consumer for three years from the date of purchase against functional defects. During year one, parts, labor, and freight are covered. During year two, parts and freight are covered. During year three, parts only are

warranted at 50% of retail price; freight and labor charges are not included. The tent is not warranted against fading, discoloration, soiling, leaking due to contaminants, or problems resulting from misuse or abuse.

- 2G. The warranty of paragraphs 2A through 2F is not transferrable and is limited to functional defects only.
- 3. Return within ten days of retail purchase of the warranty registration form provided with the folding trailer is a requirement to obtain warranty performance. The Warranty Registration Form will also permit Fleetwood to locate consumers in the unlikely event of a product safety recall. Fleetwood will send the customer an owner's card that reflects the warranty data for the trailer.
- 4. During the specified times, any defective parts in a Fleetwood folding trailer will, at Fleetwood's option, be either repaired or replaced on an exchange basis with new or reconditioned parts. This Warranty does not cover the expense to take the folding trailer to the dealer for repair, nor the return expense. The consumer must pay all expenses incurred in obtaining warranty performance other than those specifically provided for in this Warranty.
- 5. The date of retail sale is established by the Warranty Registration. Replacement parts are warranted for the unexpired duration of the original warranty.
- 6. To obtain warranty performance:
 - 6.1 Consult the yellow pages of the telephone book under "Trailers - Camping and Travel" for the name, address, and telephone number of the nearest authorized Fleetwood folding trailer dealer; or call Fleetwood Folding Trailers, Inc. at 814/445-9661. (Collect calls will not be accepted.) Call the authorized Fleetwood folding trailer dealer, report the problem and schedule an appointment. Take the trailer at the scheduled time to the dealer along with the owner's card sent to you by Fleetwood. Only authorized Fleetwood folding trailer dealers may perform warranty obligations.
 - 6.2 The authorized Fleetwood folding trailer dealer will advise when the warranty performance has been completed. All payments for warranty service and for parts will be made by Fleetwood to the dealer and not to the consumer.

General Exceptions and Exclusions

- 7. To the extent any or all of the following exclusions or provisions of this warranty are prohibited by any federal, state, or municipal law which cannot be preempted, those exclusions or provisions shall not be applicable.
 - 7.1 THERE ARE NO OTHER EXPRESS WARRANTIES EXCEPT AS SET OUT ABOVE AND ANY IMPLIED WARRANTIES, INCLUDING THE IMPLIED WARRANTIES OF MERCHANTABILITY AND FITNESS FOR A PARTICULAR PURPOSE, ARE LIMITED IN DURATION TO THAT OF THE EXPRESS WARRANTY. Some states do not allow limitations on how long an implied warranty lasts, so the above limitation may not apply to you.
 - 7.2 THIS WARRANTY DOES NOT COVER CONSEQUENTIAL DAMAGES, INCIDENTAL DAMAGES, OR INCIDENTAL EXPENSES, INCLUDING DAMAGE TO PROPERTY. Some states do not allow the exclusion or limitation of incidental or consequential damages, so the above limitation or exclusion may not apply to you.
 - 7.3 This warranty does not cover damages caused by failure to perform normal and routine maintenance as set out in the folding trailer owner's manual.

- 7.4 This warranty does not cover damage caused by mishandling, neglect, abuse, misuse, lightning, or corrosive atmospheres.
- 7.5 This warranty shall not apply if the serial number plate is removed or defaced.
- 7.6 The tent material is not warranted against fading, discoloration, soiling, or problems resulting from misuse or abuse. Ripped or torn tents will be repaired or replaced at Fleetwood's sole discretion through an authorized Fleetwood folding trailer dealer, provided the rips or tears are noted prior to retail delivery.
- 7.7 Top assemblies are warranted only for functional defects such as leaks. Any nonfunctional or cosmetic problems that are not noted prior to retail delivery are not covered by this warranty.
- 7.8 The vinyl floor covering is warranted for gouges, cuts, or tears only if noted prior to retail delivery. Such damage noted prior to delivery shall be remedied by repair or replacement at Fleetwood's sole discretion.
- 7.9 The lightbulbs, fuses, tire valve cores, and other similar items are not covered by this warranty and are sold AS IS.
- 7.10 The tires, water heater, electric water pump, porta potti, furnace, and refrigerator in trailers so equipped are warranted by their respective manufacturers. A copy of the warranty for each of these components is provided with the folding trailer.
- 7.11 Trailers used for rental purposes are covered by this warranty for three (3) months from the date of purchase by the rental dealer; or if rented by an authorized Fleetwood folding trailer dealer, from the date of rental registration.
- 7.12 This warranty applies only to products sold at retail in the United States and Canada.
8. This warranty does not cover extra expenses such as transportation to and from the dealer or manufacturing plant location, loss of time, loss of pay, loss of use of the folding trailer, inconvenience, commercial loss, towing charges, bus fares, vehicle rental, incidental charges such as telephone calls or lodging bills, or other incidental or consequential damages (other than injury to the person).
9. Fleetwood Folding Trailers, Inc. reserves the right to make changes in the design or material of its products without incurring any obligation to incorporate such changes in any product previously manufactured.
10. This warranty gives you specific legal rights, and you may also have other rights which vary from state to state.

REPORTING SAFETY DEFECTS

If you believe that your vehicle has a defect which could cause a crash or could cause injury or death, you should immediately inform the National Highway Traffic Safety Administration (NHTSA) in addition to notifying Fleetwood Folding Trailers, Inc.

If NHTSA receives similar complaints, it may open an investigation; and if it finds that a safety defect exists in a group of vehicles, it may order a recall and remedy campaign. However, NHTSA cannot become involved in individual problems between you, your dealer, or Fleetwood Folding Trailers, Inc.

To contact NHTSA, you may either call the Auto Safety Hotline toll free at 800/424-9393 (or 366-0123 in Washington, DC area) or write to NHTSA, U.S. Department of Transportation, Washington, DC 20590. You can also obtain other information about motor vehicle safety from the Hotline.

CHANGE OF OWNERSHIP NOTIFICATION

MODEL INFORMATION

YR. _____ MODEL _____

SERIAL NUMBER _____

NEW OWNER INFORMATION

PURCHASE
DATE _____

NAME _____

ADDRESS _____

CITY _____

STATE/PROVINCE _____ ZIP _____

PREVIOUS OWNER INFORMATION

PURCHASE
DATE _____

NAME _____

ADDRESS _____

CITY _____

STATE/PROVINCE _____ ZIP _____

NOTE:

This card is to be completed and sent to Fleetwood Folding Trailers, Inc. ONLY after the original retail purchaser transfers ownership of the trailer to another party.

NOTICE TO DEALER AND CONSUMER

Because brake requirements are governed by state or provincial regulation, the requirements vary from state to state. To insure compliance with applicable regulations, we recommend you check with your Department of Motor Vehicles to determine if brakes are required on your trailer. The weight specifications in the owner's manual will assist you in making this determination. Available through your dealer is an accessory electric brake package which can be installed on your trailer without any problem.



NO POSTAGE
NECESSARY
IF MAILED
IN THE
UNITED STATES

BUSINESS REPLY MAIL
FIRST CLASS PERMIT NO. 83 SOMERSET, PA 15501

POSTAGE WILL BE PAID BY ADDRESSEE

FLEETWOOD FOLDING TRAILERS, INC.
ATTN: WARRANTY SERVICE DEPT.
POST OFFICE BOX 111
SOMERSET, PA 15501-9985

