COLEMAN^R

Pioneer^R Series

ColumbiaTM
Newport^R
Chesapeake^R

AmericanaTM Series

Sun ValleyTM
AltaTM
LaramieTM
Shenandoah^R
Sequoia^R
Williamsburg^R

**1990 MODEL
CAMPING TRAILER
OWNER'S MANUAL**



Camping Trailer Division

P.O. Box 111
Somerset, PA 15501
(814) 445-9661
FAX (814) 445-6558

To Our Valued Customer:

It is our pleasure to welcome you to the Coleman family. Your new camping trailer was designed by a team of specialists who are dedicated to making your camping experiences the most memorable time of your life!

For over 85 years the Coleman Company has built a solid reputation in providing quality products with features that offer safety, comfort, and luxury.

A favorite quotation of W. C. Coleman, the founder of the company, was, "No product is really sold until it is delivering a satisfactory service for the user." Today, as well as in the future, no matter where you travel you will find that Coleman will be there to serve you.

You will be glad you chose Coleman - The Number One Camping Trailer in the World!

Patrick O. Scanlon
President
Camping Trailer Division

Larry Marsh
Vice President of Sales and Marketing
Camping Trailer Division

WELCOME . . .

to the wonderful world of carefree living you'll be enjoying in your new Coleman camping trailer. Like all Coleman products, your Coleman camping trailer is the best in its class - loaded with all the quality and craftsmanship that have made Coleman world famous for over 85 years.

This manual shows you in easy-to-read language how to get the most out of your camper the easy way, plus tips on maintenance that will keep your camper rolling through the years - virtually trouble-free. A quick look at the "Table of Contents" will show you what we mean.

So, before you take off, take a little time to read the sections on Pre-Trip Preparations, Set-Up Instructions, Take-Down Instructions, Loading, and Maintenance. It's easy reading and it really does show you how to get the most out of your camper - the easy way. Have a good trip - after all, you're traveling first class in a Coleman camping trailer!

TABLE OF CONTENTS

INTRODUCTION	i
IMPORTANT CONSUMER INFORMATION	ii
PRE-TRIP PREPARATIONS	1
HINTS AND TIPS	2 - 5
Loading Camping Trailer Accessories	2
Necessities	2 - 4
Towing	4
Tips on Picking a Campsite	4 - 5
SET-UP INSTRUCTIONS	6 - 18
Getting Started	6 - 8
Stabilizer Jacks	8 - 9
Bed Set-up	9 - 10
Tent Enclosure Set-up	10 - 11
Wardrobe Set-up, Shenandoah Model	11
Screen Door Set-up	11 - 13
Galley Set-up	13 - 14
Dinette Set-up	14 - 15
Bed Bow Support Set-up	15 - 16
Stove Set-up	16
Electrical and Water Hook-ups	16 - 18
Access to Outside Storage	18
TAKE-DOWN INSTRUCTIONS	19 - 22
SYSTEMS AND SPECIAL FEATURES	23 - 39
Trailer L.P. Gas System	23 - 25
Trailer Electrical System	25 - 26
Water System	27 - 30
Tracking System	30 - 34
Lift System	34 - 35
Tent Enclosure	35 - 37
Miscellaneous Standard Features, Williamsburg Model	37 - 38
Outside Stove Set-up, Sequoia Model	38 - 39
MAINTENANCE	40 - 42
WARRANTY	43 - 45
SPECIFICATIONS	See Enclosure

INTRODUCTION

This manual contains important information regarding the safe operation and maintenance of your Coleman camping trailer. We urge you to read it carefully, understand all aspects of your trailer, and follow the recommendations to obtain the most trouble-free use of your recreational vehicle.

In this manual, statements preceded by the following words are of special significance:

"WARNING" means that there is a high possibility of serious personal injury to yourself and others if the warning is not complied with.

"CAUTION" means that there is the possibility of personal injury to yourself or others.

"IMPORTANT" means that there is a possibility of damage to the trailer if instructions are not followed.

"NOTE" indicates points of particular interest for more efficient and convenient operation.

We recommend that you take particular notice of these items when reading this manual.

NOTE:

The words "shall" or "must" indicate a requirement which is essential to satisfactory and safe product performance.

The words "should" or "may" indicate a recommendation or advice which is not essential and not required but which may be useful or helpful.

Please remember that when service is required, your Coleman camping trailer dealer knows your vehicle best. Consult him for any assistance you may require.

NOTE:

Federal law requires you to register the serial numbers of your trailer tires. For your protection, the original equipment tire serial numbers must be recorded on the warranty registration form received with your trailer. Your dealer will supply you with the necessary forms to register any additional tires (spares) you may purchase. Tire registration is not a guarantee or warranty for either the tires or the trailer.

IMPORTANT CONSUMER INFORMATION

Installation and Instructions for Appliances. Operating instructions are provided for each appliance, including air conditioning appliances (other than automotive type).

This recreational vehicle is equipped with listed fuel utilization equipment and an owner's manual which contains the following information:

WARNING: L.P. gas containers shall not be placed or stored inside the vehicle. L.P. gas containers are equipped with safety devices which relieve excessive pressure by discharging gas to the atmosphere.

WARNING: IT IS NOT SAFE TO USE COOKING APPLIANCES FOR COMFORT HEATING.

Cooking appliances need fresh air for safe operation. Before operation, open a window.

This warning label has been located in the cooking area to remind you to provide an adequate supply of fresh air for combustion. Unlike homes, the amount of oxygen supply is limited due to the size of the recreational vehicle, and proper ventilation when using the cooking appliance(s) will avoid dangers of asphyxiation. It is especially important that cooking appliances not be used for comfort heating as the danger of asphyxiation is greater when the appliance is used for long periods of time.

A warning label has been located near the L.P. gas container. This label reads:

DO NOT FILL CONTAINER(S) TO MORE THAN 80 PERCENT OF CAPACITY.

Overfilling the L.P. gas container can result in uncontrolled gas flow which can cause fire or explosion. A properly filled container will contain approximately 80 percent of its volume as liquid L.P. gas.

Do not use portable fuel-burning equipment including stoves inside the recreational vehicle. The use of this equipment inside the recreational vehicle may cause fires or asphyxiation.

Do not store L.P. gas containers, gasoline, or other flammable liquids inside the vehicle because a fire or explosion may result.

IF YOU SMELL GAS:

- 1. Extinguish any open flames, pilot lights, and all smoking materials.**
- 2. Do not touch electrical wires.**
- 3. Shut off the gas supply at the tank valve(s) or gas supply connection.**
- 4. Open doors and other ventilating openings.**
- 5. Leave the area until odor clears.**
- 6. Have the gas system checked and leakage source corrected before using again.**

L.P. gas regulators must always be installed with the diaphragm vent facing downward. Regulators that are not in compartments have been equipped with a protective cover. Make sure that regulator vent faces downward and that cover is kept in place to minimize vent blockage which could result in excessive gas pressure causing fire or explosion.

PRE-TRIP PREPARATIONS

Before you seek out those favorite recreational campsites with your new Coleman camping trailer, we suggest you first make these pre-trip preparations.

Read the information in this booklet very carefully. Please note that the text for the set-up and take-down instructions does not differentiate between models. When the text does not apply to your model, continue on to the next applicable step. Set up and take down the trailer per the instructions several times to familiarize yourself completely with the procedure.

Establish a tool kit for your trailer's maintenance needs and stow it in the trunk of your tow vehicle. The following items should be included:

1. Standard slot screwdriver
2. Standard phillips screwdriver
3. Hydraulic or scissor jack (1 1/2 ton)
4. 13/16" lug wrench
5. Stabilizer jack handle (furnished - store in access door)
6. Crankshaft handle (furnished - store in access door)
7. Tool case or pouch
8. Four blocks of wood (approximately 2"x6"x10")

Final preparations should include the proper loading (See **LOADING**) and physical check of the trailer before the trip.

The trailer should be loaded with three basic rules in mind:

1. Keep your trailer as light as possible.
2. Distribute the weight as evenly as possible.
3. **Be certain that a minimum of 10% of the overall trailer weight is on the ball hitch of the tow vehicle. Less that 10% will result in a negative tongue weight causing whipping or swaying while towing.**

A physical check should also be made per this checklist. Be certain that:

1. Tires are inflated to the recommended pressure as indicated on the vehicle ID plate, tires, or specification page. (See **MAINTENANCE**.)
2. Wheel lug nuts/bolts are properly torqued: 8" wheels, 70 lbs; 10" wheels, 85 lbs. Check torque before first trip. Retorque after first 25 miles. Retorque after first 75 miles. Retorque periodically thereafter and before each trip.
3. The tongue coupler is securely fastened to the ball hitch with safety pin in place.
4. The safety chains are attached (chains must crisscross).
5. The electrical pigtail is connected.
6. All lights on the trailer are functioning properly.
7. The L.P. gas bottle valve is closed.
8. The cooler and other items are securely held in place.

We hope you read and follow these instructions and helpful hints very closely. If you do, you will receive the maximum benefit from your Coleman camping trailer.

HINTS AND TIPS

Gathering all the equipment needed for those camping outings can and should involve the entire family. When packing your camping gear, use this handy checklist to assist the first few times, and remember one simple rule: **KISMIF** - "Keep it simple; make it fun!"

A few good tips to keep in mind are:

Reduce the weight and increase gas mileage.

Water tanks do not need filling unless primitive camping is planned; fill water tanks at campground to reduce towing weight.

Set your new camper up in your driveway to clean it thoroughly **PRIOR** to loading it.

Make your first trip close to home if possible. This will serve as a shake-down trip to see that everything works and what other items you will need to take.

Remember - the whole idea is to **MAKE IT SIMPLE, ECONOMICAL, AND ENJOYABLE!**

1. Loading Camping Trailer Accessories

The following list is designed to help Coleman campers load their camping trailers efficiently and be prepared for fun in the great outdoors.

Important Accessories

Spare tire
Canopy
Camp stove
Privacy curtains
Drinking water hose (always connect ends)
Electrical extension
Lawn chairs
Axe with safety cover; small shovel for campfire
Door mat or outdoor carpet
Small broom
Coleman wardrobe rack (for hanging clothes)
Portable toilet, chemicals, paper
Drain hose or waste container

Storage Area

self-storing
self-storing
under table
self-storing
under table
under seat
under table
trunk of car
door entry
under table
under seat cushion
designated location
under dinette seat

2. NECESSITIES

A. Miscellaneous Items

Flashlight, spare bulb, and batteries
Clothesline and pins
Insect repellent

First aid kit
Scissors
Two small waste cans

B. Personal Care Items

Toilet articles
Shower shoes
Small sewing kit

Bath and beach towels
Washcloths

C. Clothing Articles

Large laundry bag for dirty clothes; these can be stored under a seat cushion.

Lightweight jackets should be kept in camper year 'round and can be stored under the seat cushion.

Nylon duffle bags or old pillow cases with drawstrings are more convenient than suitcases. One or two bags per person will carry jeans, shirts, underclothing, etc. These are stored on beds during the day and under the table, seat cushions, or in auto trunk during travel.

D. Recreation Equipment

Balls
Radio
Inflatable rafts or any type of water sports equipment

Bikes
Games

E. Cooking

One large non-stick surface frying pan
Good kitchen knife
Potholder/glove
Tea kettle
Large cooking spoon
Paper plates
Charcoal and lighter
A few plastic plates as serving plates or straw plate holders
One or two pots with lids (stainless steel is best)
Small kettle grill is an option, however many camping sites have barbecue grills

Plastic spatula
Tongs
Hot/cold cups
Can/bottle opener
Small dishpan
Plastic forks, knives, spoons

NOTE:

Pots and pans or heavy items should be stored in lower cabinets. Lightweight items such as paper goods can be stored in upper galley and may remain there during travel.

F. Food

Take small amounts of staples and food to keep weight down. Buy food in supermarkets along the way day to day as needed. Plan your meals one day in advance according to your taste and your locale; for example, if you are near the coast, get fresh seafood. Planning this way keeps the trailer weight down and keeps fresh food available.

Plastic containers are excellent to store staples like sugar, flour, salt, pepper, etc.

Canned food items and heavy items are best stowed in drawers or in small boxes on lower shelves in the galley unit. Bread, crackers, cereal, etc., are easily stored on upper shelves with paper goods and remain there during travel.

G. How To Pack Your Coleman Cooler

1. A solid block of ice is many, many more times more effective than ice cubes in maintaining cold temperatures and will last four to five times longer than ice cubes.
2. Foods to be kept in the cooler should be prechilled before placing them in the cooler. The cooler should not be expected to act as a refrigerator in that it will not chill food, but it will maintain cold temperatures in foods that are prechilled.
3. The cooler should be packed as full as possible for the cold contents of the cooler help maintain the internal cool temperatures; and the less space there is inside the cooler, the more effective the cooler will be. Cans and bottles do very little to help maintain cold temperatures in a cooler, whereas packaged items will stay cold and help retain the cold and will utilize greater air space than cans or bottle.
4. The cooler door should be opened as little as possible to minimize the loss of cold air; and when working inside the cooler for any length of time, such as rearranging items, it is best to place the cooler in the horizontal position for there is less cold air loss than in the vertical.

3. Towing

Read these pointers on how to tow, then practice a bit before you go.

Even if you've towed before, you'll want to get the feel of maneuvering any new outfit, so practice starts, stops, parking, braking, and turning. When driving around town, always check the traffic clearance before pulling out from the curb or shoulder into the main traffic flow. For turns, pull past your turn or intersection sufficiently before turning so as not to run into the curb or obstructions. The longer your trailer, the wider you must swing for clearance. Most new owners are surprised at how well Coleman trailers track and how little additional maneuvering space is required, but don't let this cause you to forget it's behind you.

During parking or backing, remember that the rear of the camping trailer moves opposite to the rear of the towing vehicle. Start by simply placing your hand on the bottom of the steering wheel, then moving your hand left (wheel turning right) will move the trailer to the left and vice versa.

On the road, maintain a safe driving distance from other vehicles. A safe driving distance is the total length of your towing vehicle and camping trailer combined for each ten miles per hour of speed.

When approaching a downhill grade, downshift, letting the engine compression act as a brake. Should you need added braking, apply your brakes as required.

When approaching an uphill grade, the answer is the same - downshift. This keeps the engine from lugging down which may overheat from laboring in a higher gear.

5. Tips on Picking a Campsite

DO . . .

Find a level spot that gets some breeze or wind. The breeze will improve ventilation in your trailer and keep bugs away.

Try to find a site with trees that will provide shade in the afternoon when the sun can get unpleasantly hot.

WARNING:

Camp on high ground, not in river or creek beds where flash floods can prove to be a danger.

Locate the trailer reasonably near water facilities, toilets, and electrical hookups.

DON'T . . .

Pick a site near a busy road or boat dock. Late-arriving campers and early-rising fishermen can cause you to lose sleep.

Pick a site near standing water or swampy area. These are obvious breeding grounds for mosquitoes.

Park near any tree that has large dead branches that may blow down on your trailer.

REMEMBER . . .

Being "on wheels" is a great asset - you can always move, if you wish, to a better spot. It's a big, wide, wonderful world!

SET-UP INSTRUCTIONS

GETTING STARTED

Prior to the initial camping trip, familiarize yourself completely with the operation, care and construction of your new Coleman camping trailer. Upon your first camp, we suggest that you set up your Coleman camping trailer slowly and per the set-up instructions to prevent unintentional damage to the equipment.

1. Select a level campsite, preferably not on soft or sandy terrain.
2. Pull or back the trailer to desired position for campsite.
3. Disconnect electrical pigtail and safety chain, and release the coupler release handle. See Figure 1.
4. Pull the lock pin (located on the tongue jack) and let the tongue jack swing down into position. Allow the lock pin to lock the tongue jack in place in the top left hole in the brackets. See Figure 2.

CAUTION:

Failure to engage the tongue jack lock pin could result in the trailer tongue falling resulting in injury to yourself or others.

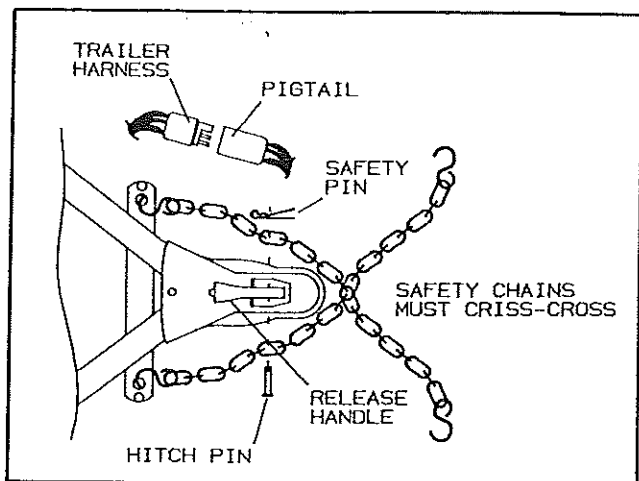

FIGURE 1

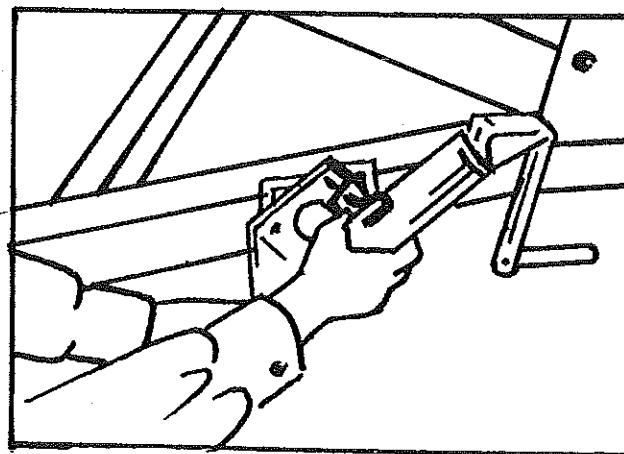

FIGURE 2

5. Pull the handle of the tongue jack up and rotate the handle in a clockwise motion to lift the trailer tongue up and off the ball hitch.
6. To prevent interference during the set up of the trailer, drive the vehicle away from the trailer or move the trailer to the desired location for the campsite.
7. Adjust the tongue jack height so that the trailer is level horizontally.
8. Unlatch the four "top" latches. See Figure 3.
9. From the right side of the trailer, insert the key into the lock (located on the access door) and turn 90° clockwise. The pushbutton and handle will pop out. Rotate the handle 90° clockwise to open the access door. Pull out and down on the access door to provide an entrance.

IMPORTANT:

Before lowering the access door, insure that the area directly beneath the access door is free from obstacles to prevent damage to the exterior finish of the access door.

10. Remove the crankshaft handle from the recommended stowage location in the access door step and attach it to the crankshaft located on the upper curbside area of the front body panel.

11a. On Americana series trailers, open the crankshaft cover or door then turn the posi-action control handle clockwise to the "open" position (see Figure 4). Make certain the safety latch mechanism rests on the center crankshaft and rotate the crankshaft handle in a clockwise motion to raise the top. See Figures 4, 5, and 6.

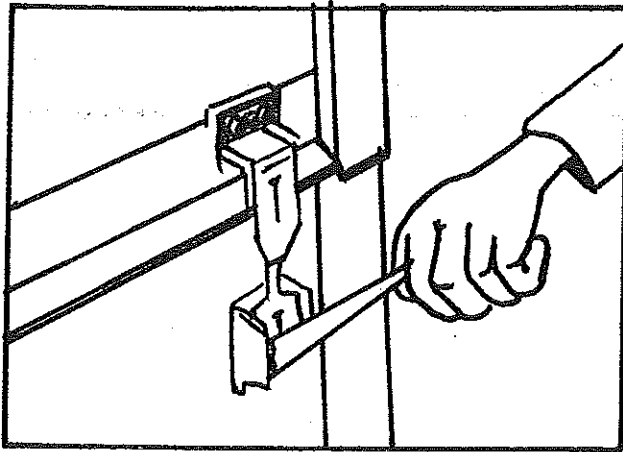

FIGURE 3

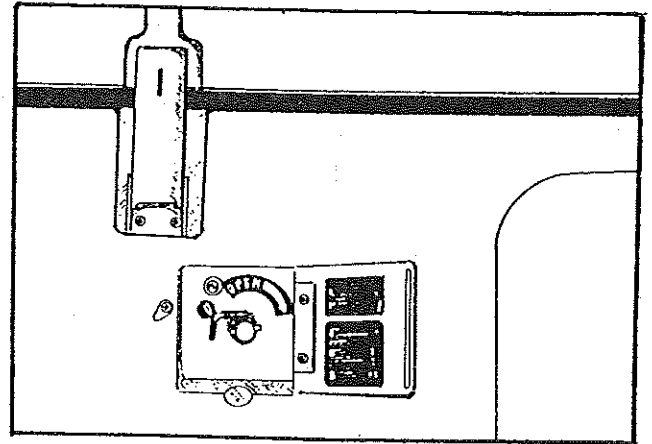

FIGURE 4

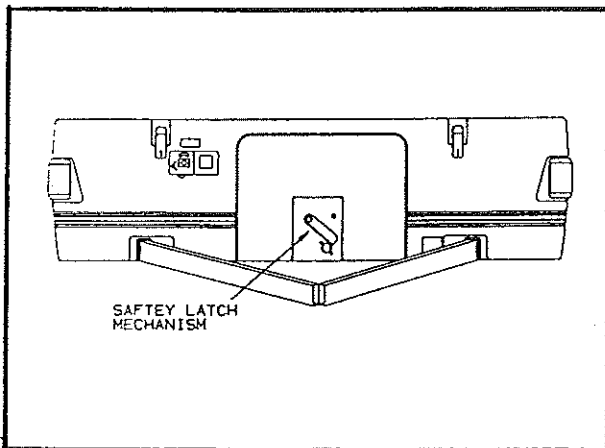

FIGURE 5

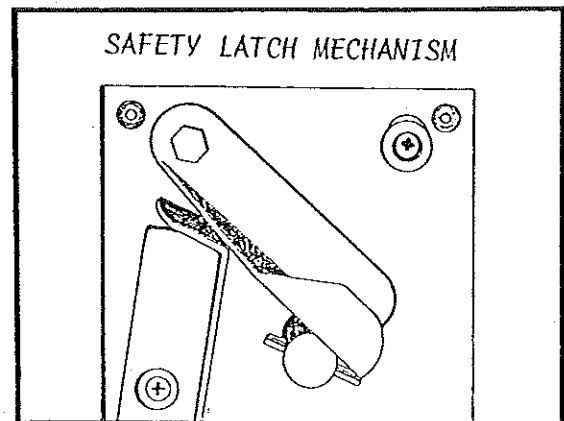

FIGURE 6

CAUTION:

The safety latch must be engaged to prevent accidental top assembly descent in the event of ratchet or chain failure.

11b. On Pioneer series trailers, it will be necessary to engage the crankshaft hook to hold the top up. Engage the crankshaft hook prior to releasing the crank handle. The crankshaft hook is located adjacent to the lower center crankshaft.

CAUTION:

Keep a constant inward pressure on the crankshaft handle to prevent the crankshaft handle from backing

off the crankshaft. During the lifting of the top **DO NOT RELEASE THE CRANKSHAFT HANDLE** without engaging the crankshaft hook located adjacent to the center crankshaft on Pioneer series trailers or the position control and safety latch on the Americana series trailers. Bodily injury could result if the handle is released and spins freely when raising or lowering the top.

12. Raise the top until it is fully extended or the tent fabric becomes reasonably taut, whichever occurs first.

CAUTION:

Be certain the posi-action control and safety latch (Americana Series) and/or the crankshaft hook (Pioneer Series) are engaged. Failure to engage these safety mechanisms could result in the uncontrolled descent of the top assembly.

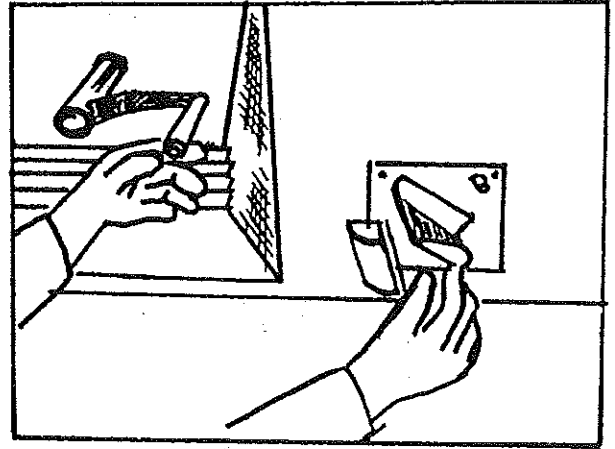

FIGURE 7

IMPORTANT:

DO NOT crank the top to an extreme tautness, otherwise the cables can be stretched or broken.

STABILIZER JACKS

CAUTION:

Do not lower the stabilizer jacks prior to raising the trailer top as this can place an undue stress on the trailer frame and lift system resulting in premature wear. Do not use the stabilizer jacks to take the weight of the trailer off of the tires except when changing a flat tire. The jacks are intended **ONLY** to "stabilize."

WARNING:

Do not lie under trailer when putting stabilizers down or up. Should the trailer fall, serious bodily injury could result.

NOTE:

When the trailer has been over rough terrain and the stabilizer jacks have collected road tar, mud, or brush, it may be necessary to dislodge the foreign matter from the stabilizer jacks before lowering into position.

13. All Americana series models as well as the Chesapeake and Newport models are equipped with four stabilizer jacks. One jack is located in each corner of the trailer. The Columbia model is equipped with two stabilizer jacks, one in each rear corner.

To release the stabilizer jacks from the locked travel position, reach under the corner of the trailer, firmly grasp the jack and push it toward the center of the trailer (approximately 1/2"), and swing down to lock the jack in the lowered position. See Figure 8.

14. Each stabilizer jack has an inner leg which must be extended to the ground. Because of certain terrain conditions, it may be advisable to locate flat blocks of wood or flat rocks under the base plates of the stabilizer jacks.

15. Remove the stabilizer handle from the recommended stowage area in the access door. Using the

stabilizer jack handle, extend the inner legs of the stabilizer jacks to stabilize the trailer, making sure the handle is inserted through rear hole. Remove jack handle and stow. See Figure 9.

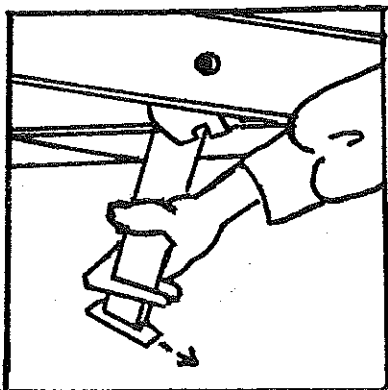

FIGURE 8

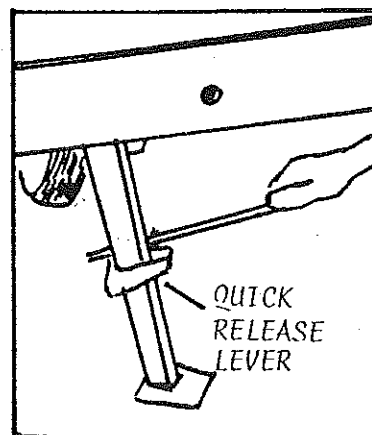

FIGURE 9

BED SET-UP

16. Standing right of center at the tongue end of the trailer, place hands (approximately 1 1/2 feet apart) on the bed frame and pull until the bed hits the stops. See Figure 10.

IMPORTANT:

This movement must be done slowly and evenly to prevent inadvertent jamming or wedging of the bed on the sliding tracks.

IMPORTANT:

DO NOT put any weight on the beds while they are extended without first attaching the bed supports as damage to the bed rails may result.

17. Kneel down beneath the side of the fully extended bed and pull down and swivel the bed support tubes from their travel positions. Lift the bed slightly while placing the free end of the bed support tube over the support peg. Perform same procedure for the rear bed. See Figure 11.

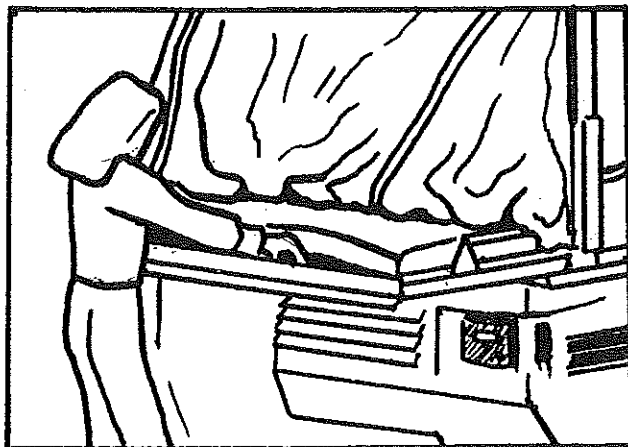

FIGURE 10

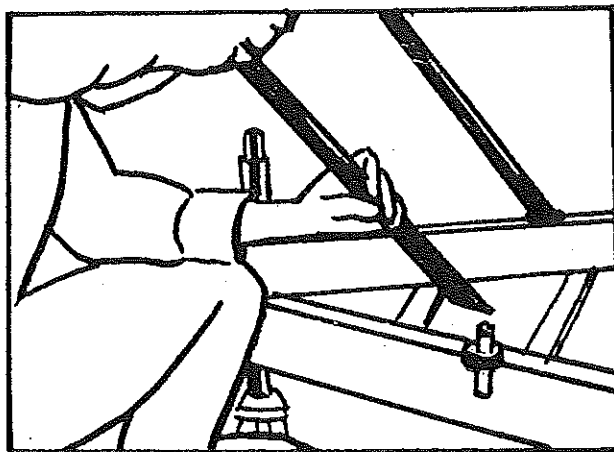

FIGURE 11

NOTE:

Queen size beds have four supports.

IMPORTANT:

Insure bed support post is fully engaged on the peg, otherwise any weight placed on the bed will cause damage to the bed's slide tracks. Bed supports are designed to swivel into travel or setup position; do not force the bed supports when setting up or taking down.

18. To set up models containing an Expanda-bed (Columbia and Alta), after pulling out rear bed and securely attaching rear bed supports to the bumper caps, set up the rear tent enclosure as described in Step 19. After the tent enclosure has been setup, go inside the camper, grasp the rear Expanda-bed at the location noted with a decal, lift and pull towards the front. The rear bed setup is now complete.

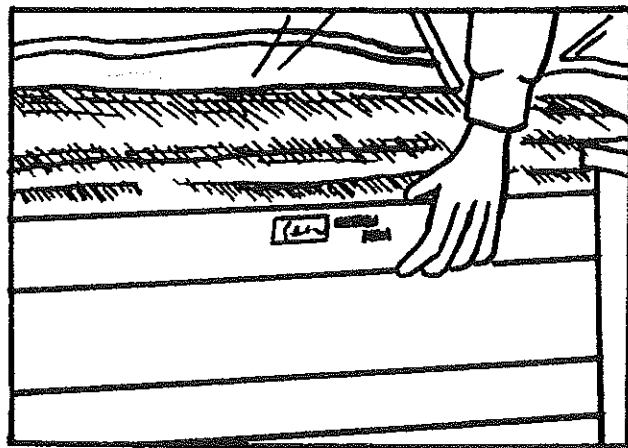

FIGURE 12

TENT ENCLOSURE SET-UP

19. With both beds fully extended and supported, grasp the bottom edge of either the front or rear tent enclosure with hands approximately 2 1/2 feet apart and gently pull until the tent fabric is supported as pictured. See Figures 13 and 14.

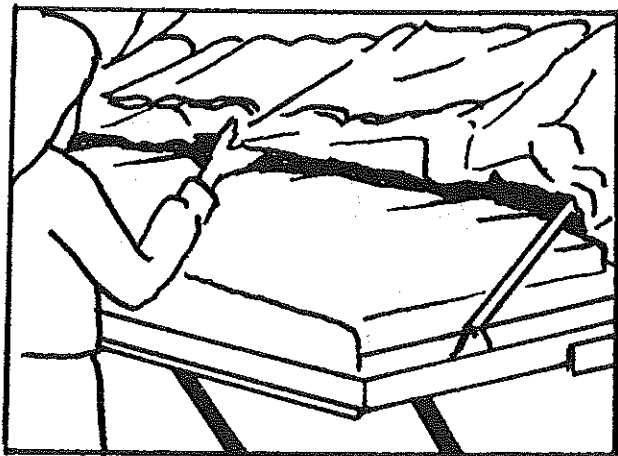

FIGURE 13

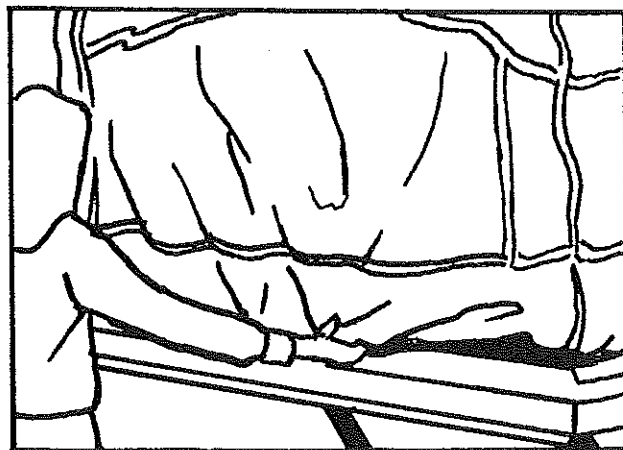

FIGURE 14

NOTE:

Before this procedure can be performed, the ties attached to the interior top corner of each tent boot must be tied to the tent support bow. For future set-ups, leave bows tied to tent.

NOTE:

The tent bow on the Columbia and Alta is expandable. Adjust the tent support bow as necessary to make tent enclosure taut over the bed.

20. Pull the tent at the bottom over the bed edge and attach the exposed stretch cords to the nearest hooks on the underside of the bed. Repeat for other bed end. Be certain to slide the stiffened tent fabric sections under the bed corners between the bed bottom and body rail top. These stiffened corners

will prevent the entrance of insects drawn by the camper interior lighting.

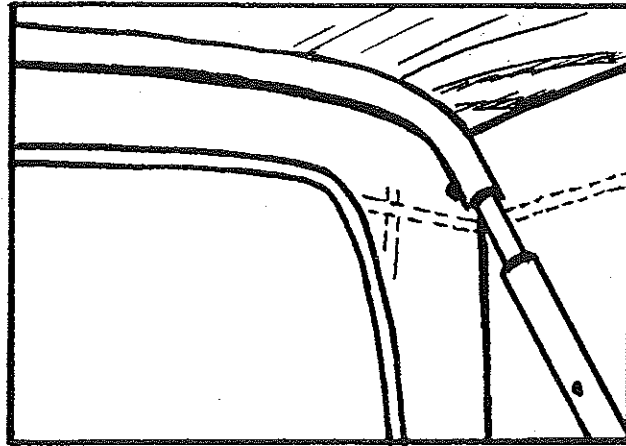

FIGURE 15

SHENANDOAH WARDROBE SET-UP

21. Grasp the handle located on the top of the wardrobe and raise the assembly until it is vertical. See Figure 16.

22. While holding the wardrobe in a vertical position, unfold the wooden rest from its storage position against the interior trailer wall and slide it under the wardrobe. See Figure 17.

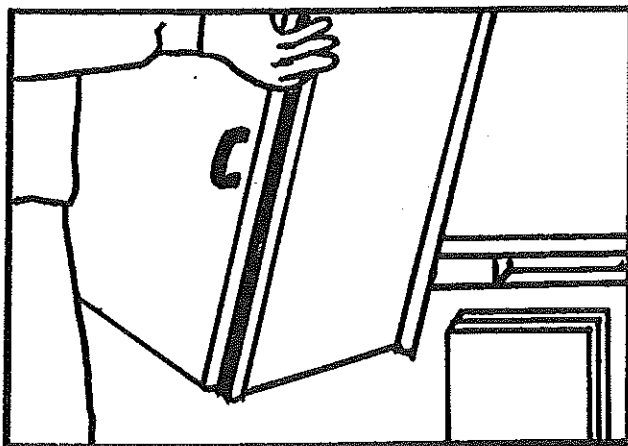

FIGURE 16

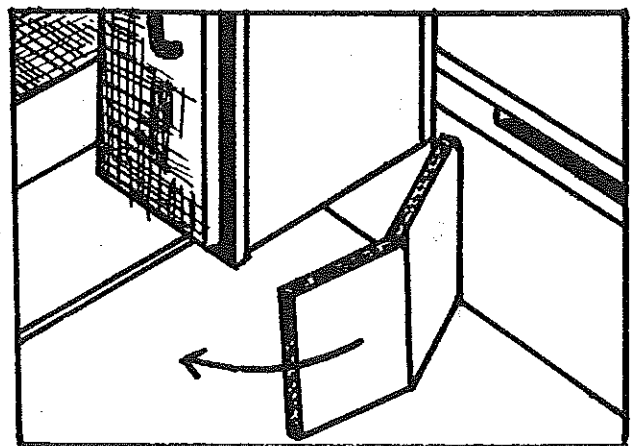

FIGURE 17

SCREEN DOOR SET-UP

23. Unfasten the two screen door web retaining straps. This will allow the screen door to hang by its glide cables.

24. Standing at the door opening, pull down on the spring-loaded pin clip retaining the door frame and swivel clear of the engagement hole. Step outside and, standing at the door threshold, reach up and grasp

the bottom of the screen door with both hands. Raise and push the door toward the far side of the trailer to release it from its retaining brackets. See Figure 18.

25. Hold screen door up from the floor and move it toward the door opening. See Figure 19.



FIGURE 18

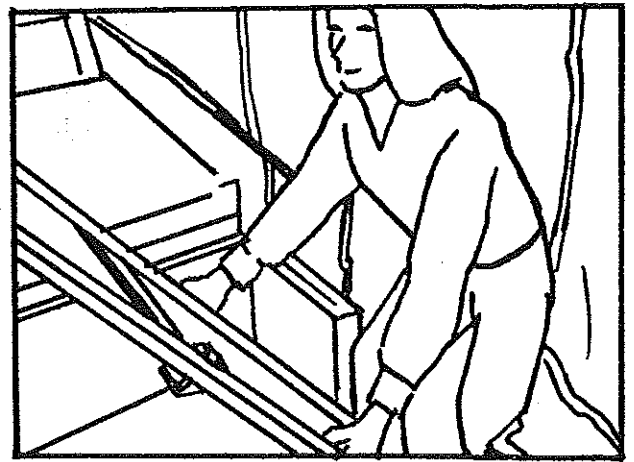

FIGURE 19

26. Grasping the door frame with both hands, one on either side, lower screen door into doorframe track at base of doorway. See Figure 20. Unlock screen door latch and step inside.

27. On Americana series, rotate the hinged top door plate to vertical position and lock in place with the two swivel latches. (Pioneer series has rigid plate.)

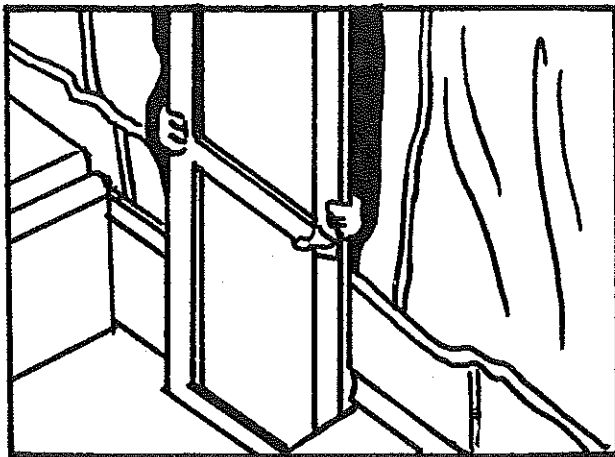

FIGURE 20

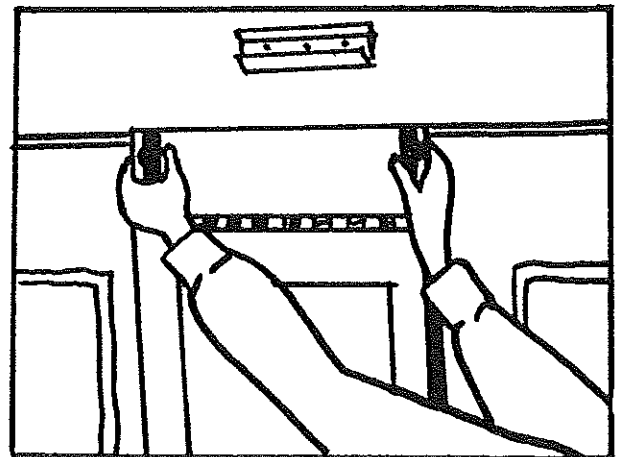

FIGURE 21

28. Step outside trailer and fasten tent retainer patches to the door jamb and body rail with the mating velcro. Starting at the base of the tent material, press the tent weatherseal on either side of the doorframe into the weatherseal groove on the doorframe.

NOTE:

On very tight tents, set-up is much easier if the screen door weatherseals are installed prior to attaching the tent at bedends. Rest each bed tent on top of the beds, install the weatherseals, and then pull the tent over the bed edges.

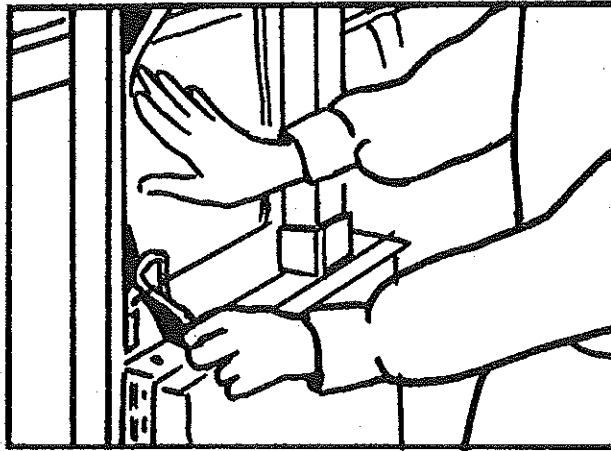

FIGURE 22

GALLEY SET-UP

Alta Model

Swing-level Stove Module (Roadside)

29. Grasp swing-level galley bar at the center and rotate 180 degrees toward the outer wall of the trailer until the upper galley is securely seated on the lower galley top.
30. Unsnap the web strap that retains the auxiliary galley shelf and remove the shelf from its storage location in the stove cabinet.
31. Insert the shelf bracket into the retainers on the left side of the storage compartment.

Sink Module (Curbside)

32. Unlatch barrel bolt at top left corner of lower galley front.
33. Incline lower galley front approximately 45 degrees or until it hits the stop position to allow access to the upper galley sink unit.
34. Grasp hinged sink unit and rotate 180 degrees toward the outer wall of the trailer. At this position, the sink will be level and at working height.
35. Raise lower galley front to its vertical location to support the front end of the sink cabinet.

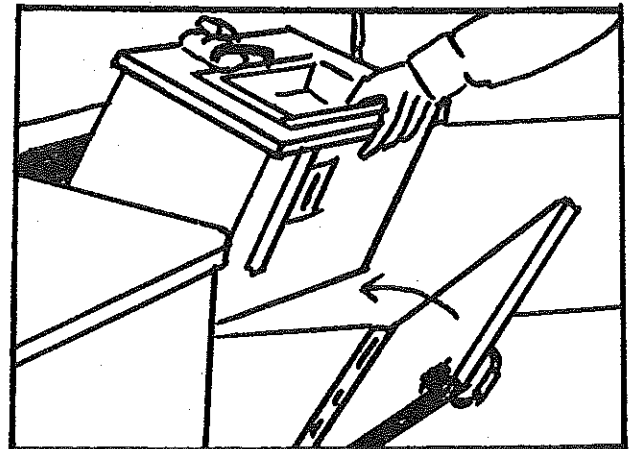

FIGURE 23

NOTE:

Ensure that the lower front edge of the sink cabinet is properly seated between the inner and outer brackets of the lower galley front.

36. Raise shelf on right side of sink cabinet to horizontal. Swing shelf support rod out and engage in bracket on underside of shelf.

Pioneer Series

37. Enter the trailer. Grasp the towel rack on the galley unit. Lift up and rotate 180° toward the outside of the trailer. See Figure 24.

NOTE:

Be certain to undo the web strap securing the water and gas hoses to the lower galley top prior to galley set up. Also check water and gas hoses to be sure they are not pinched between galleys.

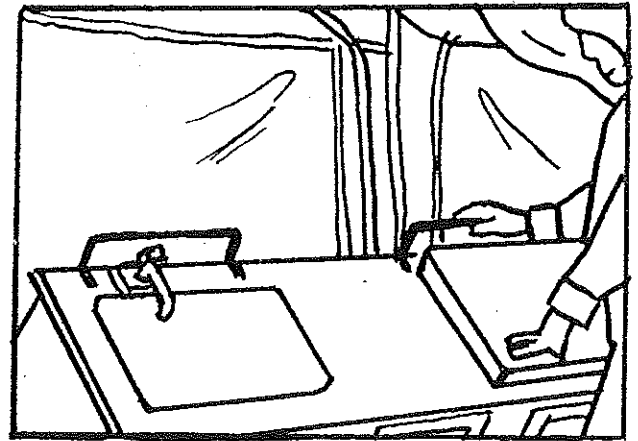

FIGURE 24

Americana Series

Grasp the center of the tubular bar of the swing-level galley and raise until the bottom of the upper galley rests securely on the top of the lower galley compartment.

CAUTION:

Be certain to grasp the swing-level galley tubular bar in the position indicated by the decal (center). Failure to do so could lead to inadvertent pinching of the hand as galley rotates.

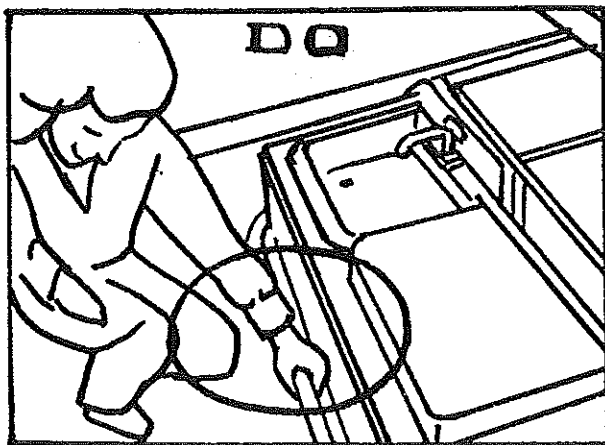

FIGURE 25

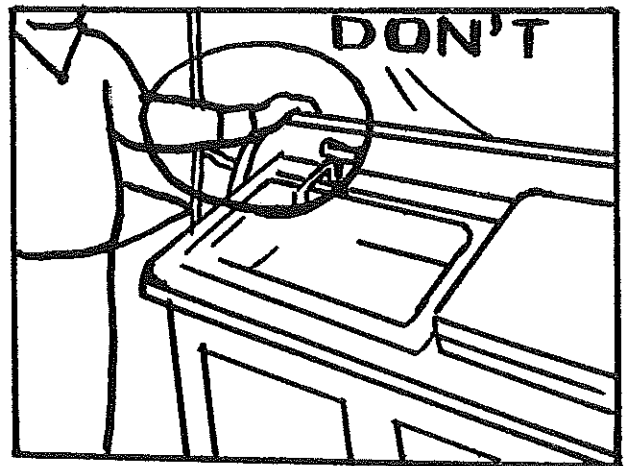

FIGURE 26

CAUTION:

Slide the safety ties attached to the bottom of the drapes behind the galley into the track behind galley. These ties eliminate the possibility of the drapes coming in contact with the stove.

DINETTE SET-UP

38a. On models with a rear dinette (Columbia, Sun Valley, Shenandoah, and Williamsburg), lift the backrest off the dinette table and slide the seat cushion inboard. Set the backrest in place against the side wall. Slide the seat cushion in place, making sure that the plastic stops are wedged firmly against the interior of the metal seat frame. (See Figure 27.)

38b. On models with a side dinette (Sequoia, Chesapeake, Newport, Alta, and Laramie), lift the backrest off of the dinette table and slide each seat cushion inboard; that is, the rear seat cushion toward the front of the trailer and the front cushion toward the rear. Set one backrest in place against the front wall of the trailer and the other against the galley side. Slide the seat cushion in place making sure that the plastic stops are wedged firmly against the interior of the metal seat frame.

NOTE:

To lift dinette seat, be certain to push the seat cushion firmly toward the backrest wall before lifting in order to prevent inadvertent damage to the plastic stops. See Figure 27.

NOTE:

A flip-up seat retainer is provided to hold the cushions upright to permit seat storage access.

39. Extend the table legs completely so that both leg supports lock into position. Set table upright and check to insure it is stable. (See Figure 28.)

CAUTION:

The table top could be damaged by exposure to rain or extended periods of sunlight.

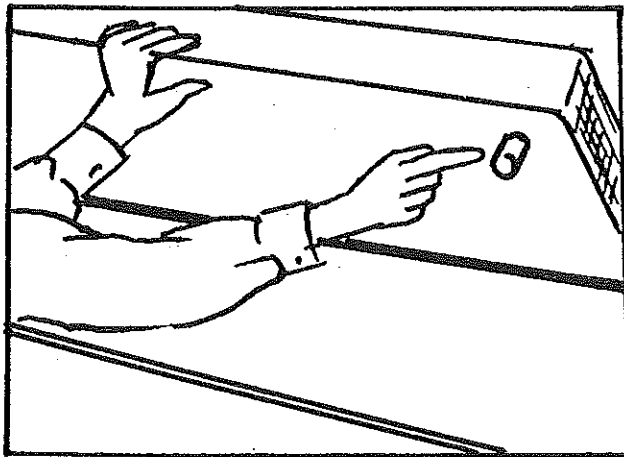

FIGURE 27

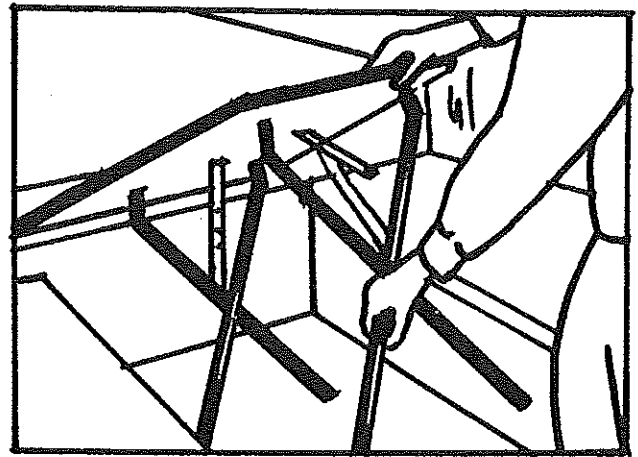

FIGURE 28

BED BOW SUPPORT SET-UP

40. Adjust bed bow support as necessary to make the tent enclosure over the bed taut. This is done by pressing the release button on the pole and extending the rod to the next hole location. See Figure 29.

41. To completely support the tent enclosure over the bed (front and rear), attach the bed bow support by inserting the straight end into the bed bow. Insert the rounded end of the bed bow support into the roof retainer. (See Figure 30.)

NOTE:

These may be stored in a preadjusted state under each mattress.

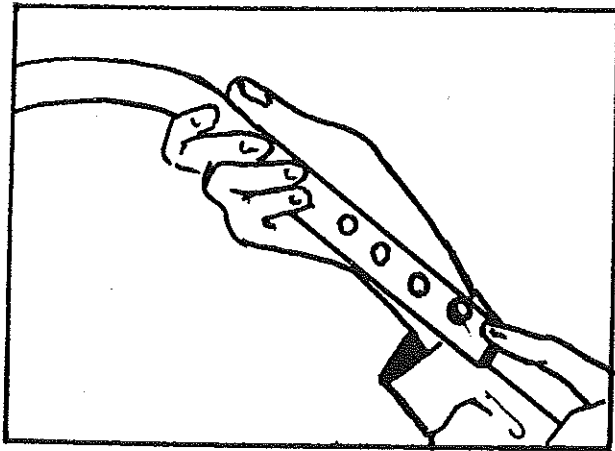

FIGURE 29

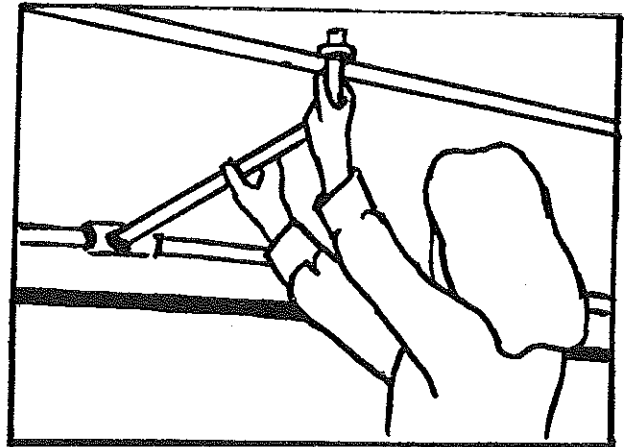

FIGURE 30

STOVE SET-UP

42. Unfasten the catch securing the stove cover. Raise the stove cover into position and lock the brace. Rotate the side baffle toward side of stove and fasten to side of cooktop with twist latch.

IMPORTANT:

Do not place hot cooking utensils on cabinet tops or table top. Damage to surface could occur.

43. Check to insure all burners on the stove unit are turned off. Open the valve on the LP gas bottle all the way by rotating the handle in a counterclockwise direction.

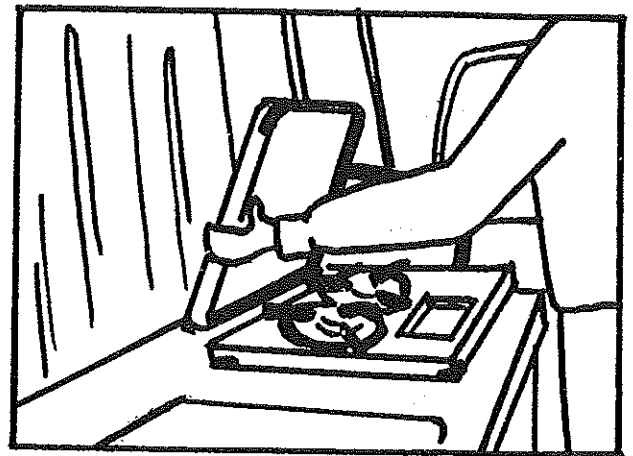

FIGURE 31

WARNING:

When trailer has been over rough terrain, test gas piping and appliances with soapy water for leakage.

DO NOT test with a lighted match. **DO NOT** tamper with the gas bottle regulator; it is factory adjusted. Failure to adhere to this warning could lead to an undetected gas leak resulting in fire and/or explosion.

44. Turn on one LP burner on the stove unit and hold a lighted match near the LP burner.

NOTE:

Initially, it will take 20-40 seconds for the gas to flow from the bottle to the burner after which the LP burner will ignite.

ELECTRICAL AND WATER HOOK-UPS

45a. When the campsite provides a pressurized water system: On Americana series, insert the key in

the utility port door and open. Remove the protective cap from the external pressure water connector. Attach a non-toxic garden hose (not furnished) between the external trailer connection and the campsite-furnished faucet.

NOTE:

The locked utility port door is standard only on Americana series trailers. Pioneer series trailers do not have a utility port enclosure door.

45b. If the campsite does not provide a pressurized water system, it will be necessary to use the trailer internal water system. In order to fill the storage tank of Americana series trailers, open the fill spout enclosed within the utility port door and fill the tank using a non-toxic hose or appropriate container. On Pioneer series trailers, the five-gallon water storage bottle can be removed from inside the trailer and filled at a suitable water filling station.

NOTE:

If city water is not connected, be sure to have the city water fill cap tight for hand pump to function properly. (See pump operation.)

46. Connect the waste system hose (not supplied) to the trailer outside fitting as identified on the trailer by the "DRAIN" decal and to the park sanitary system or suitable waste container.

CAUTION:

Do not interchange waste system hose and fresh water hose as contamination to the water supply could result.

47. When the campsite provides an electrical system: on Pioneer series, lift up the cable hatch cover, grasp the self-storing power cord plug and pull it out. Plug the power cord into the campsite-provided outlet. From inside the trailer at the power supply center, set the converter switch to the "CONVERT" position.

WARNING:

The electrical system is rated for a maximum 15 amperes normal household-type current. Be sure not to exceed this rating. Excessive amperage draw could cause electrical system problems. Be sure any outlet the trailer is plugged into is grounded and has the correct polarity.

CONVERTER:

The converter changes the 115 volt park supply to 12 VDC for operation of the interior 12 volt lights and certain 12 volt appliances (i.e., furnace, factory-installed refrigerator). The receptacles inside the trailer carry the 115 volt current for operation of 115 volt appliances and the like. Set the converter switch in the "convert" position for this type operation.

When the converter is set to "BATT," the interior electrical lights must be serviced by an external 12 volt battery for the electrical supply. This external battery could be the tow vehicle battery or a tongue-mounted auxiliary battery.

WARNING:

Do not use or store a battery inside the trailer. Battery acid leakage or explosion could cause bodily injury or death.

On the tongue of the trailer are two 12 volt DC wiring harness connectors. One connector is a six-prong connector which connects to the tow vehicle for the operation of running lights, brake lights, and so forth. The other two-prong connector is for the operation of the 12 volt interior lighting system and optional furnace. In order to use the two-prong receptacle, it is necessary to purchase the 12 volt auto extension

cord from your dealer. This cord may be plugged into the tow vehicle cigarette lighter to provide 12 volt power to the interior of your camper.

IMPORTANT:

Never allow the 12 volt, two-prong receptacle to be plugged in while the trailer is in the closed position. Excessive heat build up in the interior lights could cause damage to the tent material of your camper.

ACCESS TO OUTSIDE STORAGE

48. Americana series trailers not equipped with a built-in refrigerator have as standard equipment an outside access storage compartment. In order to gain entrance to the compartment from the outside of the trailer, simply insert the trailer key into the lock on the storage compartment, turn 90° clockwise, and raise the outside storage panel. Retain in position with the panel support provided. When closing the panel, be certain the lock is fully engaged by turning the key 90° counterclockwise. Access to this storage compartment can be gained with the trailer in either the closed or open position.

TAKE-DOWN INSTRUCTIONS

1. From inside the trailer, flip the circuit breaker and converter switch to the "OFF" position.
2. Disconnect the power cord from the campsite outlet and return the cord and plug to its storage location. Close cable hatch on Pioneer series and access door on Americana series..
3. Disconnect the non-toxic garden hose from the campsite-provided faucet and the external trailer connection. Stow the hose.
4. Attach the protective cap onto the external city water connector to prevent foreign matter from entering the internal water system. On Americana series, close and lock the utility port door.
5. Close the valve on the L.P. gas bottle all the way by rotating the handle in a clockwise direction until the valve seats.

CAUTION:

Do not attempt to operate any propane appliance while the trailer is in tow.

6. From inside the trailer, open and light one L.P. burner and allow to burn until flame extinguishes. This will safely and effectively bleed the system.
7. Turn L.P. burners to off. Pull the stove cover down and secure for travel with the catch. See Figure 31.
8. Drain all water in the sink and tighten basket strainer.
9. Disconnect the waste system hose from the external trailer connection. Thoroughly rinse the hose and store. Replace drain cap.
10. Close all drapes completely and remove safety ties from curtain track located behind the galley.

NOTE:

For quicker camp set-ups at a later time, it may be desirable to leave the drapes up throughout the trailer. The drapes may wrinkle slightly, but the wrinkles will fall out during the next camp set-up. If drapes are left hanging, be sure to unhook drapery ties.

11. Detach both front and rear bed bow supports from the roof retainer and from the bed bow. Lay the bed bow supports under each mattress. See Figure 30.

NOTE:

Remove any accessories that are mounted to the top assembly (i.e., wardrobe rack, vanity board, or overhead cabinet) if the trailer is so equipped.

NOTE:

The Expanda-bed should be taken down in the following manner:

Grasp the bed frame at the location noted with a decal, lift and push this section of bed onto the stationary section. It may be necessary to slightly lift one mattress section to ease this movement.

12. Lift the dinette table up on end. Apply inward pressure to the leg support locks and lower and

secure legs by attaching the elastic cord over both dinette legs.

13. Secure the dinette table by locating it on the rests between the bench seats. See Figure 28.

14. Remove the backrests from their positions. Slide the seat cushions outboard and place the backrests, cushion side down, on the stored dinette table. See Figure 27.

15. Step outside the trailer. Begin at the top of the doorframe and carefully pull the tent weatherseal on either side of the doorframe from the weatherseal groove attached to the doorframe. Unfasten tent velcro patches from door jamb and body rail. See Figure 22.

16. Step inside the trailer and release the top door retainers. Lock the screen door latch. Grasping the doorframe with both hands, one on each side, lift up and remove from the door threshold and allow the door to tip inward. See Figure 21.

17. Step outside the trailer and grasp the bottom of the doorframe, lift up and push the top of the door toward the far side of the trailer. Place the bottom of the door onto the pins on the retaining bracket and lock spring-loaded pin clip into base of door frame (see Figure 18) and snap web retaining straps. Be certain door is securely engaged on all three pins.

18. On Shenandoah model, lower wardrobe in the following manner: Grasp wardrobe handle and lift slightly. Fold the wood brace against the interior trailer wall. Lower wardrobe to the trailer floor.

19. On Alta model, to take down stove module, remove shelf from bracket retainers on left side of stove cabinet. Insert shelf brackets in slotted holes on back side of stove cabinet. Place web strap over shelf and snap at top edge of stove unit to secure shelf in travel position. Grasp swing-level galley bar in center and rotate stove cabinet to floor to place in travel position.

20. On Alta model, to take down sink module:

- a. Drain sink and sink drain lines.
- b. Tighten basket strainer securely in sink to prevent backflush of drain water.
- c. Release shelf support rod from bracket on underside of shelf.
- d. Fold shelf support rod and hinged shelf against side of sink cabinet.
- e. Lift the front end of the sink cabinet high enough to disengage the cabinet from the brackets on the lower galley front.
- f. Incline lower galley front approximately 45 degrees or until it hits the stop position.
- g. Carefully rotate hinged sink unit to the storage location, resting on the floor.
- h. Raise lower galley front to its vertical position and latch barrel bolt to retain in travel position.

21. On Pioneer series trailers, grasp the towel bar of the galley unit, reach behind the galley at the left rear corner and release the locking mechanism by depressing the lock while raising and rotating the galley unit 180° to the inside of the trailer and lower gently to the floor. See Figure 24.

For the swing-level galley, grasp the center of the tubular bar at designated location, rotate and lower to trailer floor. See Figures 25 and 26.

NOTE:

Be certain floor is clean and free of any grit or sand to prevent damage to the surface of the telescoping hole cover.

22. Step to the tongue end of the trailer; release the exposed stretch cords from the hooks located under the extended bed. **Pull the stiffened corners of the tent out from between the bed and body rail.**

23. Pull the tent up and over the bed edge. Grasp the bed bow and push toward the center of the trailer until it lays flat on the bed. Insure that the tent material is evenly distributed over the bed to facilitate closing of the top assembly.

NOTE:

On Columbia model, release the adjustable locks on the rear tent support bow and collapse the bow to the storage position.

24. Kneel down beneath the right side of the extended bed. With one hand, raise the bed gently and with the other hand remove the bed support tube from over the support peg. Swivel each support tube up and lock into the travel position. See Figure 11.

25. Repeat step 24 for the left side.

26. Insure the tent fabric is up away from the bed edge. Standing at the center, place hands on the bed frame and push until the bed hits the stops. This movement must be done slowly and evenly to prevent inadvertent jamming or wedging of the bed on the sliding tracks. See Figure 10.

27. Perform steps 22 through 26 for the remaining extended bed.

28. Set up the trailer tongue jack if it was previously retracted to the towing position.

CAUTION:

Be sure the tongue jack is supporting the trailer tongue and is locked in position to prevent sudden collapse of trailer tongue.

IMPORTANT:

Do not lower top unless the stabilizers are released.

29. Remove the stabilizer jack handle from the stowage location.

30. Press on the quick-release lever of the stabilizer jack with the jack handle and push downward slowly. This releases the stabilizer jack and the corner of the trailer will drop somewhat.

WARNING:

Stand clear of the trailer when pressing on the quick-release lever for the trailer will drop when it is released. Do not lie under the trailer when releasing or lowering the stabilizers. Bodily injury could result due to the quick drop of the trailer if these warnings are not followed.

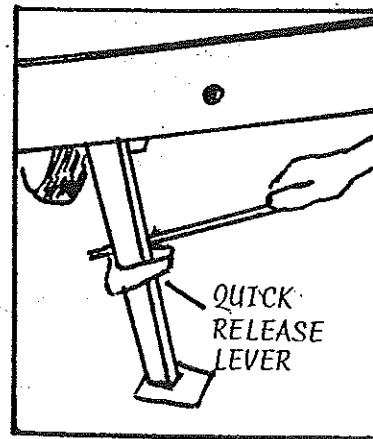

FIGURE 32

31. With the quick-release lever in the disengaged position, slide the inner stabilizer leg up into the stabilizer jack until it locks in position.

32. Grasp the stabilizer jack, pull down and push up toward the center of the trailer into its horizontal travel position. Jiggle and pull back the stabilizer jack to insure it is up and locked into position.

33. Perform steps 30, 31, and 32 for the other three stabilizer jacks and then stow stabilizer jack handle.

34. Remove the crankshaft handle from stowage location and attach to the crankshaft.

35. On Pioneer models, rotate the crankshaft handle clockwise slightly to relieve the tension on the crankshaft hook. Disengage the crankshaft hook. On Americana models, turn the posi-action control handle and the safety latch counterclockwise to allow the top to be lowered. Close and secure crankshaft cover or door. See Figures 4 and 5.

36. Rotate the crankshaft handle in a counterclockwise motion and lower the top to within one foot of the trailer. Engage the crankshaft hook or turn posi-action control handle clockwise to the open position to hold the top.

WARNING:

Keep a constant inward pressure on the crankshaft handle to prevent the handle from backing off the crankshaft. When lowering the top **DO NOT RELEASE THE CRANKSHAFT HANDLE** without engaging the posi-action control on Americana series or the crankshaft stop located adjacent to the center crankshaft on Pioneer series. Bodily injury could result if the crankshaft handle is released or backs off the crankshaft when raising or lowering the top.

37. Tuck in any tent fabric which may have worked its way out between the rooftop and trailer. This is important because if the tent fabric is pinched between the top and the aluminum rail it can become worn or discolored. Remove the crankshaft stop or turn the posi-action control counterclockwise and crank the top down fully.

IMPORTANT:

If the top will not seat properly onto the trailer, **DO NOT** force it. Raise the top to approximately one foot and recheck tent distribution.

38. Stow the crank handle, lock the doorstep and then latch the four top latches.

39. Adjust the tongue jack so that the trailer tongue is higher than the vehicle hitch ball.

40. Back the vehicle close to the trailer and set brake.

41. Using the tongue jack, lower the trailer tongue onto the ball hitch of the vehicle. Engage the coupler release handle by pressing down into the locked position. The coupler has a hole in it for a safety clip or padlock to be inserted for trailer theft protection.

42. Retract the tongue jack wheel fully by turning the handle counterclockwise until it stops, pull the release pin and swing the tongue jack up to the travel position. Bring the tongue jack handle up and over the tongue jack to store.

43. Attach the safety chains so they "crisscross" under the ball.

44. Connect the electrical pigtail to the mate.

45. Check to see that all lights on the trailer are functioning properly.

SYSTEMS AND SPECIAL FEATURES

TRAILER L.P. GAS SYSTEM

Liquid propane gas is used in your trailer for three basic reasons: it is inexpensive, portable, and burns with intense heat. This system has been checked at our factory and by your dealer to insure its safety. Except for the simplest maintenance, this system should be checked by an authorized L.P. gas supplier should any problems develop. Due to the importance of this system and the safety precautions built into it, we feel it best to take a little time to describe it to you.

A. Gas Bottle

The L.P. gas is stored under pressure in the gas bottle located on the tongue of your trailer. This bottle should be kept free of rust at all times. If rust should develop on the bottle, the area should be cleaned completely of the rust, primed, and repainted white. Quite naturally, the service valve on top of the tank should always be closed when the tank is not in operational use, and especially when in transit.

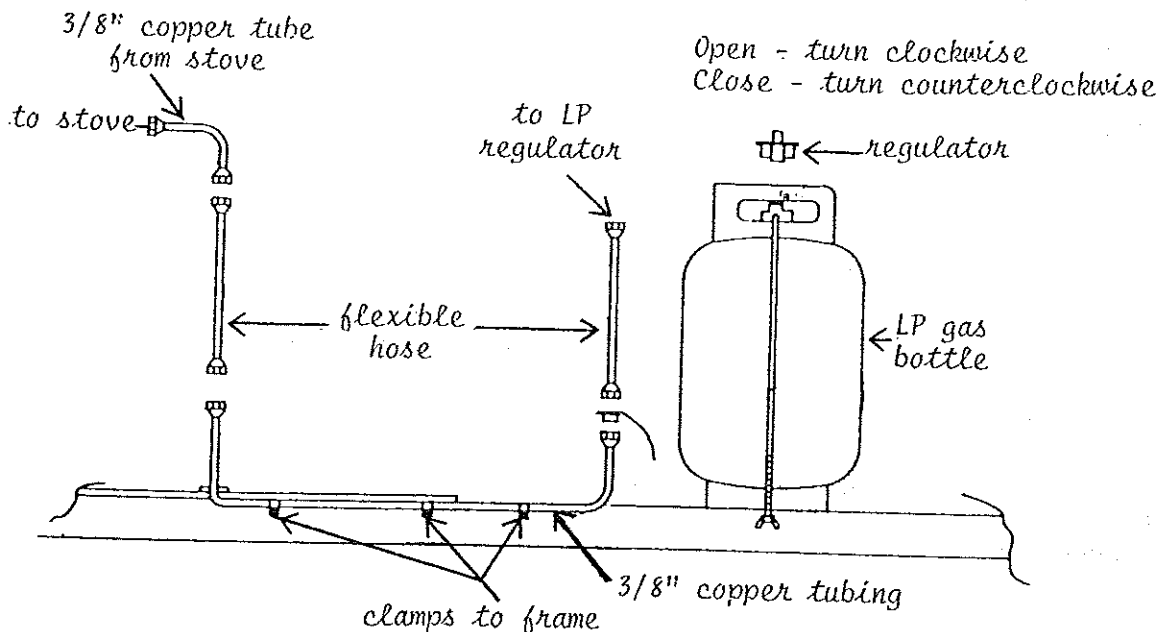

In order to change an L.P. gas bottle, follow these eight steps:

WARNING:

Do not smoke while changing the L.P. gas bottle and extinguish all surrounding open flames to avoid the possibility of fire and/or explosion.

NOTE:

Position L.P. tank with safety valve pointing away from trailer. Additional fittings are required as appliances are added i.e., water heater, furnace, refrigerator.

1. Turn off the L.P. gas at the burners. Be sure to check all three.
2. Close the valve on the L.P. gas bottle by turning it in a clockwise direction.
3. Disconnect the regulator to the L.P. gas bottle, using a suitable wrench.

NOTE:

These are left-hand threads. Turn clockwise to loosen.

4. Loosen the wing nuts from the J-bolts and remove the empty gas bottle.
5. Carefully place the full L.P. gas bottle on the tongue support and secure with the J-bolts and wing nuts loosened in Step 4.
6. Using a suitable wrench, attach the regulator (with the vent facing down) to the L.P. gas bottle.

NOTE: These are lefthand threads. Turn counterclockwise to tighten.

7. Open the valve by turning it in a counterclockwise direction slowly.
8. Check for leaks by using a soap suds solution on all gas system fittings. We suggest that all gas system fittings in the trailer be checked for leaks with a soapy solution each time a gas bottle has been changed, every 30 days, or after the trailer has tracked over rough terrain. If the soapy solution is used and a leak is indicated by bubbles at a connection, tighten that particular connection sufficiently to stop the leak. If bubbles persist, close the L.P. gas bottle valve and contact your Coleman camping trailer dealer or L.P. gas supplier for assistance.

If a leak is suspect in the trailer, you will notice that L.P. gas has a distinctive odor. Should this be encountered, follow these directions:

1. Open the door and exit the unit, leaving the door open.
2. Close the valve on the L.P. gas bottle.
3. Do not touch electrical switches.
4. Extinguish any open flame.
5. Allow the trailer to ventilate thoroughly.
6. Check all stove valves to insure they are in the "off" position.
7. Check all pilot lights to make certain they are burning.
8. Check system for leaks by following steps outlined in Item 8 above.

B. Gas Bottle Regulator

The gas bottle regulator is the heart of your L.P. gas system. It is an automatic device with working parts which move continuously. Consequently, it requires more care, protection, and attention than any other part of the system. The basic function of the regulator is to take a high and varied inlet pressure from the gas cylinder and reduce it to a safe and consistent low outlet pressure to the gas appliances. Whatever the pressure is in the gas bottle, and it will vary due to atmospheric conditions, the regulator's job is to reduce it to 6.35 ounces or 11" water column outlet pressure, and supply fuel downstream at this pressure in whatever volume is required to efficiently operate each appliance as the demand is made.

The regulator is equipped with a vent because it is constantly "breathing." That is, the diaphragm of the regulator moves down and draws air into the bonnet or adjustment spring housing. When the diaphragm moves up, the air is expelled through the vent. In the event that excess pressure builds up in the lower housing or body of the regulator, a relief mechanism vents it to the atmosphere. It is imperative, therefore, to check the vent frequently to be sure it is clean and free of water, corrosion, or obstructions as clogging is the most common cause of regulator malfunction. If the vent does become clogged, it can easily be cleaned with a toothbrush. In addition, your regulator should be checked periodically by a competent L.P. serviceman to be sure that it is properly adjusted and in safe working condition. By following these simple precautions, your regulator will give you years of trouble-free service.

WARNING:

If the regulator vent becomes plugged, excessive pressure will cause the appliance to leak, making fire and/or explosion possible and causing subsequent damage to the appliance.

C. How Should the Regulator Be Mounted?

The regulator will function regardless of the position in which it is mounted; however, the recommended mounting position is with the vent vertically down or in a direct line opposite the inlet. If for any reason this is not possible, bear in mind that it is extremely important that the vent be pointed in a direction which results in the least likelihood of dirt, water, or other foreign materials getting into the regulator. It is also important to install the regulator in a position in which the cover cannot possibly become a receptacle for water or other foreign materials.

D. What is Freeze-Up?

A regulator does not freeze, nor will L.P. gas; however, as the gas passes through the regulator, it expands and cools, and moisture in the gas or in the regulator will turn into ice. This ice can build up and totally or partially block the orifice and thus partially or totally block the fuel supply. There are a number of things you can do to prevent this type of freeze-up:

1. Before it is filled, Be sure the L.P. cylinder is totally free of moisture by drying any visible water around the valve area.
2. Be sure the cylinder is not overfilled. Insist that the bottle never be filled beyond 80% liquid level.
3. Keep the valves on an empty cylinder closed.
4. Have your L.P. dealer purge the cylinder if freeze-up occurs.
5. If necessary, have your L.P. dealer inject methyl alcohol in the cylinder.
6. Keep the cylinder in an upright position.

E. If a gas bottle is overfilled, a built-in pressure mechanism on the bottle will allow excess gas to escape. It is imperative, therefore, that once bottles have been filled that they always be stored outdoors in an upright position whereby complete ventilation is possible. As an example, if a bottle is filled during extremely low temperatures, an increase in temperature will allow the gas to expand and possibly trigger the release valve. The presence of this gas in a confined area could result in fire or explosion caused by exposure to an open flame.

TRAILER ELECTRICAL SYSTEM

The electrical system of your camper is broken down into two separate and distinct functions - the 12 volt direct current and 110 volt alternating current. The 110 VAC is used solely for the operation of interior 110 VAC receptacles. The 12 VDC is used for all other functions including running lights, interior lights, and the operation of 12 VDC appliances (i.e., furnace). By using the power converter, 110 VAC is converted to 12 VDC for the operation of interior lights and optional furnace.

A. 12 Volt Vehicular Electrical Circuit

The 12 volt DC electrical circuit is dependent on the tow vehicle's battery or an extra battery. Frequent and regular checks of the vehicle battery should be made to assure electrical system stability. We suggest the following checks:

1. Battery terminals and posts free from corrosion.
2. Battery terminals securely fastened to the battery posts.
3. Battery water level.
4. Battery voltage at the level specified by the vehicle manufacture.

Before each trip, make an operational check of all DC electrical functions of the trailer: turn, stop, side marker, and taillights. If a bulb does not light, remove the lens cover from over the bulb not functioning. Most often, bulb replacement will cure the malfunction; however, should the malfunction persist, secure the aid of a voltmeter and the wiring diagram contained herein and check the DC voltage and/or continuity of the circuit. Repair or replace as required.

B. 115 Volt AC Power Supply

The 115 volt AC power cord is located under the roadside dinette seat. This power cord can be plugged into a park supply power source for the operation of interior receptacles only. The converter will change the 110 volt AC park supply to 12 volt DC current for interior lighting and optional furnace operation. Please refer to pages 17 and 18 of this manual for additional operation and use of the power converter.

WIRING DIAGRAM

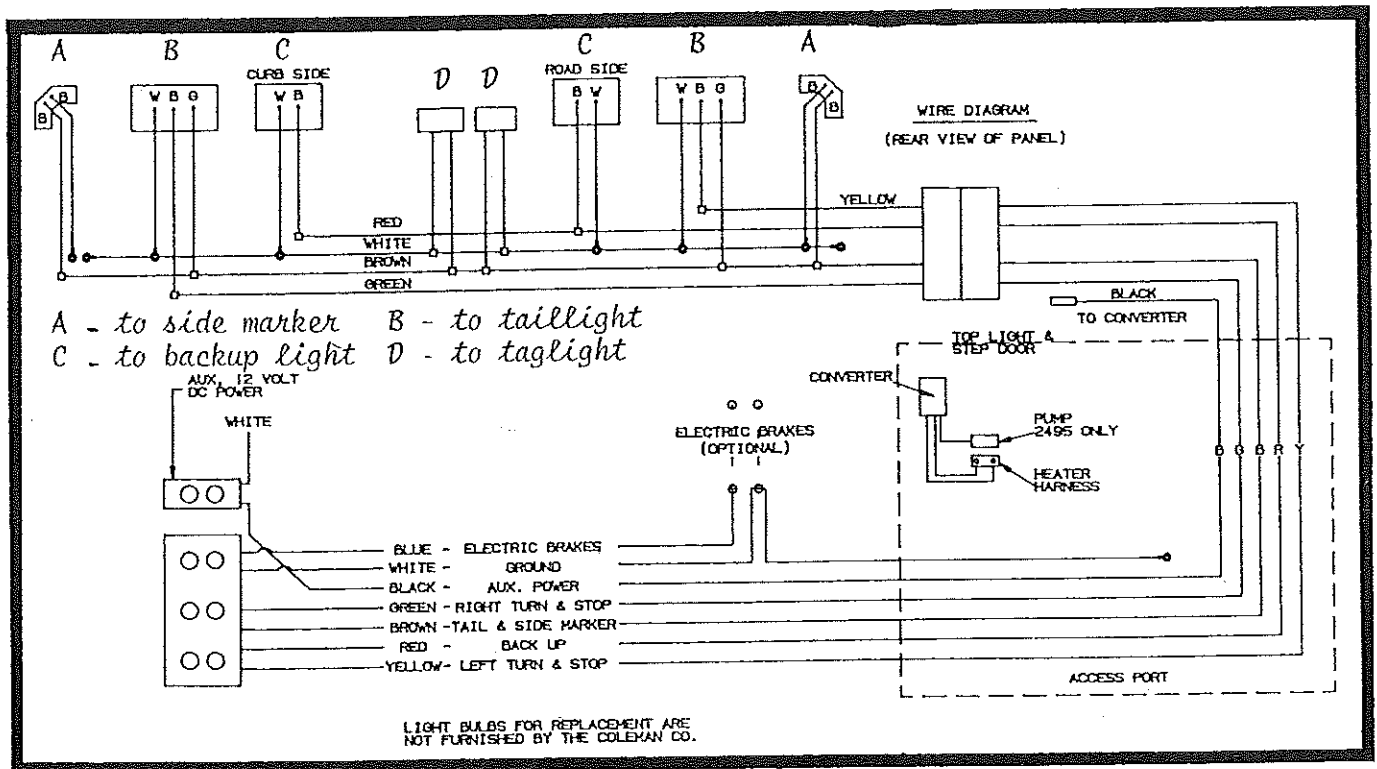

General Trailer Wiring Diagram

WATER SYSTEM

Fresh water may be supplied to your trailer sink (and tub and shower unit in the Williamsburg model) from one of two sources - the water tank or the city water hookup. Fixtures for both of these are located beside each other on the roadside body panel and are marked accordingly. When the city water is turned on, it will bypass the internal water tank with the exception of the water heater only). In order to be sure the water heater is filled, it is wise to open the hot water faucet slightly to allow the escape of trapped air.

A. Water Tank System

To insure complete sanitation of the potable water system, we suggest the following procedure be used on a new system, one that has not been used for a period of time, or one that has become contaminated.

1. Prepare a chlorine solution using one gallon of water and 1/4 cup of Clorox or Purex household bleach (5% sodium hypochlorite solution).
2. Pour one gallon of solution into tank.
3. Complete filling of tank with fresh water.
4. Open the faucet until all air has been released from the pipes and entire system is filled. Pump water up to the sink.
5. Allow to stand for three hours.
6. Drain and flush with potable fresh water.
7. To remove any excessive chlorine taste or odor which may remain, prepare a solution of one quart vinegar to five gallons water and allow solution to agitate in the tank for several days by vehicle motion.
8. Drain tank and again flush with potable water.

NOTE:

The built-in water tank is equipped with a screen filter which is located in the outlet fitting or at the pump. The filter should be cleaned periodically to insure maximum pump efficiency. Contact your dealer for the removal of this filter.

Once the internal water system has been cleaned, flushed, and refilled, water can be pumped by raising and lowering the pump handle. When using the city water supply, depress the pump handle which will allow city water to flow freely

B. Sink Drain

The outlet port for the sink drain is located on the same side of the trailer as the sink and the location is identified with a "drain" decal affixed to the body panel. The sink can be drained by simply removing the plastic protective cap from this fitting and allowing the water to flow freely from the sink. Please note that this fitting is threaded and an elbow provided to allow the fastening of a rubber hose in order to drain the sink into a park-provided facility or waste container.

C. 12 Volt Electric Demand Water Pump (Williamsburg Model Only)

The electric demand water pump in your unit is warranted solely by its manufacturer. The electric pump can be activated for use by pushing the switch button located on the roadside seat panel. Once the unit is activated, it will automatically switch on and off depending upon water use. Instructions for the specific care, use, and service of this component are enclosed with your trailer. This electric water pump is only to be used when a city water hook is not available and water must be drawn from the storage tank and water heater.

IMPORTANT:

Do not allow the electric water pump to run when the water system is dry. Subsequent damage to the pump mechanism will result.

D. Tub and Shower Unit (Williamsburg Model Only)

Before easing into your shower after a "long day on the trail," take a few moments to read these helpful hints to further enhance your enjoyment of the ultimate in camping pleasure - a hot shower!

1. Connect a garden hose (not supplied) to the tub drain located on the lower portion of the right front body panel and route to a park-supplied drainage receptacle or a suitable waste container.
2. Connect the shower head hose to the tub fitting and hand tighten.
3. Adjust the shower curtain to insure that the total area around the tub is sealed and the curtain bottom is inside the tub.
4. Adjust the water temperature and enjoy "roughing it."

NOTE:

The bathtub may be converted to use as a seat by placing the cushion provided on top of the bathtub. In order to do this, the stop buttons on the underside of the cushion must be positioned so they lock against the front interior wall of the bathtub.

E. Draining the Water System

In order for the water system in your trailer to function properly for many years, it is necessary that certain precautions be taken prior to winter storage to prevent freezing of the water system lines.

1. Six-gallon gas water heater drainage:
 - a. Be sure gas is shut off at the gas bottle and the electric pump is turned off.
 - b. Remove the water heater exterior vent cover.
 - c. Using a wrench, remove the drain valve and allow the water to run out. Note water heater instructions for exact location of the drain.
 - d. Open the hot water faucet on both the sink and tub to expedite drainage.
 - e. Drain the system lines by pulling the plastic T-handle on the in-line plastic drain plug located on the underside of the trailer directly in front of the axle.
 - f. Drain the water storage tank by opening the petcock located under the trailer directly beneath the water tank.

- g. The tub may be drained by removing the protective plastic drain cap located on the bottom of the right front body panel.
 - h. Once the system is drained, replace the heater drain valve and close the in-line drain, water tank drain, and tub drain.
2. On units not equipped with a water heater or tub and shower unit, the water system may be drained by simply turning the petcock located on the bottom of the water storage tank under the trailer and allowing all water to drain out.
 3. On those units equipped with a water bottle and not an installed tank, it is only necessary to drain the lines and simply empty the bottle.

F. Winterizing the Tub Drain (Williamsburg Only)

In addition to draining the water system, additional precautions must be taken to insure against freezing. A draintrap is installed in the Williamsburg trailer directly beneath the tub and shower unit. This trap is visible by opening the access door located at the front of the tub. Water will always remain in the trap. In order to prevent damage from freezing, you must fill the trap with antifreeze prior to winter storage. This can be accomplished by simply removing the tub stopper and pouring approximately one-half pint of antifreeze into the tub drain. Your Coleman dealer can assist you with the type of antifreeze available for this application.

G. Water System Versatility (Williamsburg Only)

The water system in your Williamsburg trailer is a high-quality, versatile system. To acquaint you with the various methods of operation, a discussion of each follows:

1. City Water Supply

- a. Connect a garden hose (not furnished) to the campground-provided faucet and city fill fitting on the roadside panel of the trailer.
- b. Turn the city water supply "on" and allow the system including the hot water tank to fill.
- c. Light the water heater by following the instructions printed inside the vent cover.

IMPORTANT:

Be certain that the water heater is filled prior to lighting to prevent appliance damage.

- d. Simply turn the sink or shower faucet knob approximately 1/4 turn to draw water.
2. Use of the 18 gallon water tank. (Use when campground city water supply is not available.)
 - a. Clean and fill the plastic water tank according to the instructions on page 27 of this manual.
 - b. Connect trailer exterior power cord to 115 VAC park supply and set the power converter to "convert."
 - c. Engage the electrical demand pump by pressing the switch button located on the roadside seat panel. Once the hot water tank is filled and all faucets closed, the pump will automatically shut off.

- d. Light the water heater by following the instructions printed inside the vent cover.
- e. Simply turn the sink or shower faucet knob approximately 1/4 turn to draw water. The electric pump will automatically engage to provide needed water pressure.

NOTE:

Continual running of the water pump once all water faucets have been closed and the water heater is full indicates a leak in the system. Should this occur, do not use the electrical pump and attempt to locate the leak to prevent interior water damage. Your authorized Coleman camping trailer dealer can assist you with any needed repairs should this condition develop.

3. When a 110 VAC power supply is not available, your water system may be used exactly as described in #2 by connecting the trailer 12 VDC power supply to a tongue-mounted battery or tow vehicle outlet i.e., cigarette lighter.

WARNING:

The hot water drawn at the sink is directly out of the water heater. The temperature of the water could be as high as 150°. Scalding could occur if the hot water is not diluted. DO NOT expose the body directly to the undiluted hot water.

WARNING:

Hydrogen gas can be produced in a hot water system served by this heater that has not been used for a long period of time (generally two weeks or more). Hydrogen gas is extremely flammable. To reduce the risk of injury under these conditions, it is recommended that the hot water faucet be opened for several minutes at the sink before using any electrical appliance connected to the hot water system or lighting any gas appliance. If hydrogen is present, there will probably be an unusual sound such as air escaping through the pipe as the water begins to flow. **THERE SHOULD BE NO SMOKING OR OPEN FLAME NEAR THE FAUCET AT THE TIME IT IS OPENED.**

IMPORTANT:

Never attempt to light the hot water heater if it is not filled. Permanent damage to the heater unit could occur and such damage would void the warranty.

TRACKING SYSTEM

A. Tires

CAUTION:

To provide maximum towing ease, tire life, and trailering safety, check the following items before each trip to and from the campsite:

1. Tires inflated to recommended pressure as indicated on the vehicle identification label on the left side body panel or on the tires.
2. Wheel lugs securely tightened. (70 footpounds for 8"; 85 footpounds for 10")
3. A visual inspection of tire tread and walls for wear or cuts.

Please Note:

The tires on the Coleman camping trailer are warranted separately by the manufacturer. While the warranties of the various tire manufacturers vary in language, they in general provide that tires installed as original equipment at the factory are warranted to the owner to be free from defects

in material and workmanship for the life of the tire tread. There is no warranty coverage for damages resulting from road hazards, etc.

If a tire warranty adjustment is required, the trailer owner should contact the nearest authorized representative of the tire manufacturer. In the event there is no local representative, the customer should follow the directions set forth in the tire warranty card packaged in each camping trailer. A Coleman camping trailer dealer **MAY** be able to assist you in locating the tire manufacturer's local representative who can handle warranty adjustments. Requests for tire warranty adjustments **should not** be sent to The Coleman Company.

NOTE:

All Coleman trailers are capable of accepting different size tires. Prior to making any tire size changes, consult your dealer for tire size adaptability.

B. How to Change a Flat Tire

Tires may be easily changed in the following manner:

1. When possible, locate the trailer on level terrain and remove from the tow vehicle.
2. Block the tire opposite the one needing changing.
3. Using the tongue jack, lower tongue end down as far as the tongue jack will allow.
4. Remove the hubcap from the tire you wish to change.
5. Using a 13/16" lug wrench, break loose the lug nuts/bolts.
6. Pull down rear stabilizer jacks, extend the stabilizer jack to near full extension on the side which will be changed. Extend the stabilizer jack on the side of the inflated tire just to the ground.
7. Rotate the tongue jack handle in a clockwise motion and raise tongue end up. Stop when tire to be changed is raised approximately 3/4" off the ground.
8. Take the lug nuts/bolts off using the lug wrench.
9. Slide the tire off by placing the hands at the 3 o'clock and 9 o'clock positions on tire and pulling.
10. Slide repaired, new, or spare tire onto the axle by placing the hands at 3 o'clock and 9 o'clock positions on the tire.
11. Start each lug nut/bolt with the fingers and then use the lug wrench to draw the lug nuts/bolts reasonably tight.
12. Lower the tongue jack until the tire is on the ground. Using a lug wrench, draw the lug bolts tight (70 footpounds for 8"; 85 footpounds for 10").
13. Replace hubcap.
14. Release the stabilizer jacks.
15. Pull down and push up the stabilizer jacks into the travel position.

16. Hitch trailer to vehicle. Pull the release pin and swing up the tongue jack to the travel position.
17. Stow all tools.

CAUTION:

After you have driven a short distance (approximately one or two miles), stop and recheck the lug bolts to insure they are securely tightened. Check again after 25 miles.

C. Brakes

Trailers equipped with electric brakes must be synchronized with the towing vehicle's brakes to insure maximum controlled braking. The synchronization requires adjustment of the trailer's brake shoes, and the tow vehicle's automatic controller and selective resistor. We suggest that you secure the advice of your dealer as to the "who and where" this can be done in your area.

The initial brake adjustment should be made after 40 or 50 normal braking stops. This adjustment should be limited to the brake shoes only.

After completing approximately 200 normal braking stops, a brake system adjustment should be made.

Foregoing the "wearing in" procedural adjustments, the electric brakes need to be checked and adjusted as required, once a year.

D. Ball Hitch and Coupler

Maintain a coat of light grease on the ball hitch of your vehicle. This will induce longer ball hitch life and towing ease.

The coupler should be adjusted, when required, to maintain the coupler/ball snugness. With the coupler attached to the ball and the coupler release handle down in the locked position, adjust the lock nut (on the underside of the coupler) to compress spring to within 1/32" of solid. See adjacent figure.

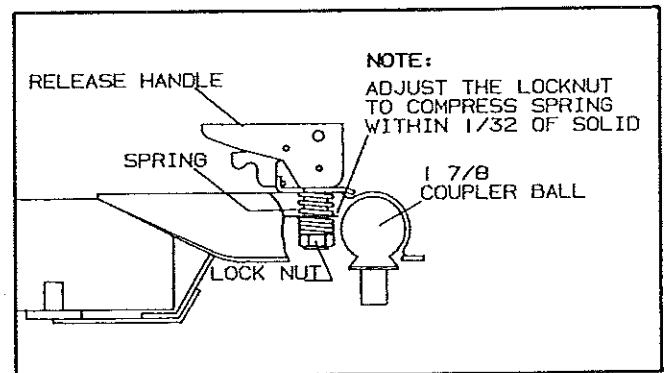

Make a visual inspection of the safety chains for damaged or corroded links; repair or replace as required. Insure the ball hitch is securely attached to the vehicle and the ball head is securely tightened.

E. Recommended Practices for Lubricating and Adjusting Wheel Bearings

IMPORTANT:

Wheel bearings should be checked before the initial camping trip and then every 2,000 miles or twice a season, whichever occurs first, and at the beginning of each camping season.

1. Lubrication - Why?

Proper lubrication is essential to all types of bearing application. The kind of lubricant used is governed by the design and operating conditions. The function of lubricants is mainly to:

- a. Reduce friction between moving parts.
- b. Carry away heat.
- c. Aid the seal in keeping lubricant in its place and keeping foreign matter out of the bearing.

Bearings will run the coolest and with the least friction when a minimum amount of the lightest bodied lubricant that will keep bearing surfaces apart is used. Heat in bearings is due to a number of causes such as: (a) too much lubricant, (b) too heavy lubricant, (c) too tight adjustment.

We probably will always have with us the man who says, "If a little is good, a lot is better." This is as great a fallacy in bearing lubrication as it is in medicine or anything else. If too much or too heavy a lubricant is used, there is bound to be an increase in temperature when the wheel starts to rotate, usually followed by leakage. An attempt to stop this by tightening the adjusting nut will increase the friction, thus still aggravating the condition until, in extreme cases, the bearing fails.

We know that our bearings have to function under high temperatures due to the electric brake heat, so we have chosen lubricants of such character that they will return to their original consistency when the bearing cools, with practically no oil separation. We use and recommend the following grease or its equivalent: Shell Darina EP2 or Sunoco Prestige 742EP.

2. Lubrication - When?

The manufacturing company recommends that wheel bearings be inspected and repacked every 2,000 miles or as required and at the start of every vacation season. A trailer sitting idle for a few months will collect some moisture in the hubs due to atmospheric conditions and this is the reason for inspecting and repacking the bearings at this time.

3. Lubrication - How?

The relubrication of wheel bearings is possibly the most important service performed to the running gear. The two most important phases of this operation are cleanliness and proper adjustment.

Before disassembly of the hub, check wheel play and freedom of rotation. Extreme or excess play indicates a too-loose adjustment or a defective bearing. Too much drag in rotation of the hub could indicate tightness in bearing adjustment or a brake being adjusted too tight.

To begin disassembly, remove the dust cap. Next, remove the cotter pin and spindle nut. Jiggle the hub slightly to loosen the outer bearing. Usually the outer bearing will loosen up enough to be removed by hand. Pull the entire hub which contains the inner bearing and grease seal. Remove the inner bearing and grease seal by placing a brass drift or piece of wood through the small end of the hub and tapping gently until the bearing and seal is loose. Wipe all dirt and grease from the inside of the hub and the spindle.

Used bearings must be cleaned prior to relubrication. Various solvents are effective for degreasing. Successful processes employ kerosene, distillates, and chlorinated hydro-carbons. The solvent action of kerosene is limited, but it has the advantage of leaving a rust-inhibitive film on the bearing. After cleaning, bearings should be allowed to drain free of solvent which might dilute lubricants. Do not immerse the grease seal in any solvents, but wipe clean with a cloth.

WARNING:

Do not use above-described cleaning solvents near or around open flames as fire or explosion could occur resulting in serious bodily injury.

Carefully inspect cups (races) and cones (bearings) for pitting, scratches, excessive wear, or other damage. If either cup or cone is worn, replace the entire assembly. In other words, do not replace a bearing unless you also replace its mating cup.

If at all possible, use a bearing packer to repack the cones. If this is not available, the bearings can be lubricated by hand if the grease is pressed into and around each and every roller. Additional grease within the hub is not required. Install the inner bearing in the hub and replace grease seal by tapping gently with a wooden block, making sure the seal is installed as it was before disassembly. Replace hub on spindle, taking care not to damage threads or grease seal. Replace outer bearing, washer, and spindle nut. Slowly rotate the hub in one direction or the other while tightening the spindle nut (maximum 50 footpounds torque) or until there is a slight bind to be sure that all bearing surfaces are in contact.

IMPORTANT:

At this point the adjusting nut is backed off 1/6 to 1/4 turn or to the nearest locking hole or castellation. This will allow the wheel to rotate freely without excessive end play. The total amount of internal running clearance between the roller and the raceways of the bearings should be within 2/1000 to 8/1000 recommended limits. This can only be measured accurately with the use of special instruments, but by simply pushing inward and pulling outward on the hub several times a person should feel a very slight end play. If the bearings are too tight or too loose, they will fail prematurely. Install new cotter pin, bend to locked position, and drive on grease cap.

We wish to stress the point that the bearings used in the hubs of the TRAVEL TRAILERS of today are subjected to higher speeds and heavier loads than a few years ago. For that reason, they must be lubricated and adjusted more accurately than before. We feel certain that maximum bearing life and performance will be consistently obtained if the methods of lubrication and adjustment we have described are followed.

LIFT SYSTEM

The lift system in your new Coleman camper is a well designed, virtually trouble-free system if used properly and within the guidelines set forth in this owner's manual. Twenty years of engineering design and improvements have gone into this system. Although this system has remained basically the same since we have been manufacturing camping trailers, we have improved the design, efficiency, and material quality. For example, the four lift assemblies on your camper are manufactured from high-quality stainless steel. The four long cable assemblies extending from the main screw shaft to each lifter are stainless steel in order to offset the severe road conditions of salt, chemicals, dirt, and so forth. The pulleys used in the lift system are all steel pulleys with steel needle-bearing inserts for long life and dependability. Contained within this section, therefore, are some hints and tips relative to the proper care of your lift system.

- A. Never crank the trailer up with weight on the roof except for a dealer-installed Coleman air conditioning unit. Additional weight placed on the top assembly while the unit is being cranked up can result in an unnecessary strain on the lift system causing cables to be stretched and the loss of proper height adjustment. Never raise or lower the roof with the stabilizer jacks set. This action can cause a bind on the trailer frame resulting in excessive pressure being placed on the four lift assemblies.

B. Maintenance

The only maintenance that will be necessary to perform to your lift system is an occasional lubrication of the pulleys contained within the lifts. This lubrication should be only a silicone spray and used very sparingly.

NOTE:

Excessive lubrication on the pulleys and lift arms can result in unsightly stains to the tent enclosure.

C. Top Adjustment

Height adjustment, if necessary, should be performed by your dealer. This service should be done at the main ballscrew system. Rough or emergency adjustment can be performed at each main cable pulley adjustable bracket. One bracket is located in each corner of the main frame tube area. Adjustments should be made as follows:

1. Crank top to approximately 12" high.
2. Place blocks under all four corners of the top to prevent descent while adjusting the cable.
3. Crank (down) a few turns to relax cables.
4. Remove pulley pin and relocate pulley to an alternate hole position. (Each hole should add about 1 1/2" to that particular corner or a maximum of 3" adjustment available at each corner. Do not overadjust or tent enclosure and weatherseals may be damaged.)
5. Raise top to remove blocks.
6. Fine adjustments can only be performed at the main ballscrew area.

IMPORTANT:

We emphasize that any customer repairs to the lift system should only be done as a stop-gap measure. Your dealer should be consulted prior to performing any lift system service to prevent inadvertent damage to the system.

TENT ENCLOSURES

A. Care and Repair of Evolution 3 Tent Fabric (For Trailers So Equipped)

This relatively newly designed material is a strong, three-layer polypropylene laminate which will resist common stains, soil, mildew, and rot. When soiling does occur, the problem can usually be corrected by the following procedure:

1. Light brushing with a soft cloth will remove most dirt. For stubborn soils:
 - a. Wet soiled fabric with water.
 - b. Wash with non-detergent Ivory Snow work into a lather with a sponge; lightly work the lather into the soiled area.
 - c. Rinse thoroughly with copious amounts of water to remove all soap residue. Soap residue will cause fabric leakage.

d. Air dry completely.

If slight fabric leaking persists due to presence of soap residue, the area may be treated with a water repellent such as 3M Scotch Guard Fabric Protector.

The above procedure may also be used to correct spot fabric leaking caused by accidental contact with insect repellents and sprays. (Products containing surfactants e.g., insect repellents, suntan oils, can cause a loss of water repellency. This can easily be corrected by following the washing instructions outlined above.)

If slight fabric leaking exists at any seam, simply coat the affected seam with a small amount of the "seam sealer" available through your authorized Coleman camping trailer dealer.

Accidental rips and tears in Evolution 3 tent fabric can be easily repaired by either sewing or by the use of a repair tape such as Ripstop supplied by Kenyon Consumer Products, 200 Main Street, Kenyon, Rhode Island, 02836. Larger holes may be repaired by stitch patching with Evolution 3 fabric. When stitch repairing, treat all stitching with a seam sealer such as K+ Kote Seam Sealer, Kenyon Industries, Kenyon, Rhode Island, 02836.

B. Care and Repair of the Canvas Tent Material (For Trailers So Equipped)

The canvas on your new trailer is a high quality, ten-ounce duck canvas. Proper care should be given to this material in order to avoid rips, tears, grease, mildew, excessive dirt and soap. Cleaning the canvas is very important. Foreign matter such as tree sap, bird droppings, etc., coming in contact with the exterior surface of the canvas can destroy the water repellency of the material and, in some cases, cause rotting or decay of the canvas. The canvas should be rinsed thoroughly with cool water and allowed to dry completely once it has come in contact with the items mentioned above. In order to remove normal dirt from the canvas, it should be brushed with a dry sponge or soft-bristle brush while dry or after wetting, and following the brushing the canvas should be rinsed with cool water. Sprays are available for renewing the water repellency of the canvas; however, your dealer should be consulted prior to their use.

IMPORTANT:

The canvas should never be stored wet for extended periods of time because it may mildew and lose its strength. If the canvas must be stored wet, set it out to dry as soon as possible.

Should mildew develop on your canvas or vinyl enclosure due to the necessity of closing the unit wet, the mildew can be removed in the following manner:

Mildew Solvent:

A simple but effective solvent to remove mildew from tents or other canvas-like fabrics can be made using ordinary household items. In about eight ounces of water, dissolve two teaspoons of salt and two teaspoons of concentrated lemon juice. Wash the mildewed cloth with this solution, then rinse with fresh water. Let dry in open air before using.

C. Vinyl Bed End Covers

The vinyl over the bed areas can be cleaned in the same manner as the canvas. When necessary, automobile convertible top cleaners can be used to remove stains.

IMPORTANT:

Follow the manufacturer's instructions carefully for use of such cleaners or damage to the vinyl surface could occur.

CAUTION:

The use of insect repellents, hairsprays, and deodorants inside the camper when sprayed on the tent surfaces will cause a breakdown of the water repellency of the fabric. We suggest, therefore, the very limited use of such sprays inside the unit during camping as damage to the tent enclosure could result.

The zippers on your tent can be lubricated by using a paraffin wax. The use of paraffin on the zippers will enhance their ease of operation around the tent sections and windows.

MISCELLANEOUS STANDARD FEATURES (WILLIAMSBURG MODEL ONLY)

A. Portable Toilet

The portable toilet in your new unit is a high-quality component serviced and warranted by its manufacturer. Please note the specific instructions enclosed with your portable toilet for its use and care. A list of service centers for this component is also provided in the unlikely event of needed service.

B. The Portable Toilet Privacy Curtain and Plastic Shower Curtain

The portable toilet privacy curtain and plastic shower curtain can be installed in the tracks located in the top assembly by following this simple procedure:

1. Slide all carriers with the hooks onto the I-beam, making sure that all hooks face the same direction. See Figure A.
2. Assemble the curtain stop to I-beam by sliding stops onto the ends of I-beam, locate approximately 1/4" from each end of I-beam, and tighten thumb screw tight with your hand. See Figure B.

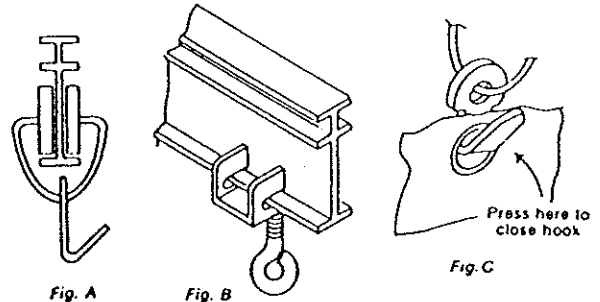

IMPORTANT:

If pliers are used, care should be taken not to overtighten. See Figure B.

3. Assemble curtain to track by placing carrier hooks on track through small eyelets in curtain. Hooks may be squeezed together with thumb and forefinger after the curtain is hung to secure it to the hook. See Figure C.
4. When the shower curtain is not in use, it may be conveniently stored in the trailer; however, curtains must be dry before storing.
 - a. Slide the curtain to the curbside of the tub unit.
 - b. Roll or fold shower curtain from the bottom up and fasten to the interior side of the top assembly with the two straps provided.
 - c. The shower curtain may be left in its stowage position for travel.

NOTE:

When your trailer is being stored for extended periods of time, it is recommended that the shower curtains be removed from the unit, folded, and stored indoors under fairly constant temperatures. Extremes of temperatures could have an adverse effect on the

plastic material.

CAUTION:

Before closing your Williamsburg for travel, it is recommended that both the dressing room curtain and shower curtain be removed from their hanging positions and stored under one of the galley seats. Possible damage or unsightly creases could occur if they are not stored properly.

OUTSIDE STOVE SET-UP (SEQUOIA MODEL ONLY)

Your Sequoia model camping trailer is equipped with access to an outside stove. This appliance may be used without setting up the camper, thereby providing cooking convenience during travel without the complete setup of the trailer. In order to hookup and use the outside stove, follow these steps:

- A. Insert the access door key into the stove door and turn 90° clockwise to open the door.
- B. Lift front locks, grasp the storage tray handle or front retainer and slide the entire unit out until it hits the retaining stops. Be certain the two locks, now at the rear, have re-engaged in the retaining slots.
- C. Lift the stove assembly out of the storage tray and set aside temporarily.
- D. Disengage the storage tray from its front retainer by lifting the tray at the rear (see figure) and slide the tray into the metal glides located directly beneath the stove shelf.
- E. Set stove on shelf and secure in place by hooking the stove handle under the front retainer bracket. (See figure.)

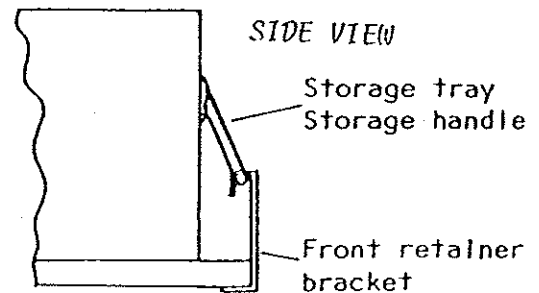

CAUTION:

Never attempt to use the stove without engaging the stove handle in the front retainer. Spills or equipment damage could result due to sliding off the stove shelf.

- F. Route the 10' hose under the trailer and hand tighten one end to the 12" hose coming from the appliance regulator and the other end to the outside stove.

CAUTION:

Hose must be placed under the access door step in order to prevent people from tripping over the hose or accidentally closing the hose in the access door.

CAUTION:

Turn on LP gas and check for leaks with a soapy water solution. Never check with an open flame as fire or explosion will occur.

- G. The outside stove is now ready for use. Cooking utensils and/or condiments may be conveniently stored in the storage tray.

When Storing the Stove

- A. Be certain to turn off the appliance regulator and the burner knobs located on the stove.

- B. Disconnect the 10' hose from the stove and the 12" section of hose coming from the appliance regulator. Hose can be kept in storage tray or wrapped around the gas bottle "well."
- C. Remove stove and set aside.
- D. Slide storage tray out of the metal tracks and place on top of the stove shelf. Hook handle on metal tray under front retainer bracket.
- E. Place stove, cooking utensils, and 10' hose (depending on choice) in the storage tray and close for travel.

CAUTION:

Do not store "hot" stove; allow to cool.

CAUTION:

Do not use stove when trailer is not level or with unreasonable weight of cooking utensils and contents which may cause utensil to slide off stove burner surface.

Do not use stove in tightly closed area. Any combustion process consumes oxygen. Your propane stove must be used with adequate ventilation. When using inside tent camper or other enclosed area, leave two openings of 20 square inches or more to provide ventilation for the proper combustion. Failure to comply may cause asphyxiation.

Do not use Coleman quick disconnect or Coleman regulator with any stove other than a Coleman propane camp stove. Failure to comply may damage the other stove, may cause gas leaks, and/or may cause other stoves to malfunction.

For additional information on your Coleman camp stove, please refer to the operating instructions received with the stove.

MAINTENANCE

COMPONENT	IDENTIFICATION	STANDARD CARE	FREQUENCY	AVOID
Appliances				
Stove		Appropriate household cleaners	As needed	Abrasive cleaners
Sink		Appropriate household cleaners	As needed	Abrasive cleaners
Countertops		Clean with warm, soapy water	As needed	Abrasive cleaners
Axle	51" spring center 64" track	U-bolts torqued to 15 - 17 footpounds	Once/season	Road hazards and overloading
Backrest and Cushion covers	Herculon/Olefin	Vacuum; foam-type cleaners	As needed	Grease, oil, excessive heat
Bathtub	ABS plastic	Appropriate cleaners	As needed	Abrasive cleaners
Bearings	Tapered roller	Lubrication See pages 32-34	Every 2,000 and before each season	Road hazards and overloading
Bed Slides	Aluminum	Use only silicone lubricant	As needed	Unsupported beds, excessive lubrication
Beds	Blandex	Proper support	Always	Abuse
Brakes	Dexter 7"	Linings and adjustment See brake manual	Before each season and as needed	Overadjustment
Canopy		Vinyl cleaner	As needed	Storing wet for extended periods
Canvas	10 Ounce duck	See page 36 of this manual		Storing wet and harsh detergents
City Water Fill		Cover when not in use	Always	Overtightening
Converter	B&W Manufacturing	Use of proper fuses as noted on converter		Overloading and to repair; sealed unit
Cooler	Coleman	Clean with mild soap and water	As needed	
Coupler	Fulton 1 7/8"	Wheel bearing grease on release lever and socket, proper adjust- ment; See page 32 of manual	Once per year	Improper adjustment
Dome Light	1.5 amps	Re-lamp only with bulb noted on fixture base	As needed	Lights on when unit is closed; operating in 12 VDC mode
Drain (Sink)		Winterize on units with swing-level galley	As needed	Freezing
Drain (Tub)		Winterize with proper antifreeze	As needed	Freezing
Drapes		Hand washable; mild detergent; drip dry	As needed	Machine washing; storing wet

MAINTENANCE

COMPONENT	IDENTIFICATION	STANDARD CARE	FREQUENCY	AVOID
Evolution 3		See pages 35-36 of this manual		
Exterior Finish				
Metal Panel	Krystal Kote	Wash with water and apply quality auto wax	As needed	Abrasive cleaners; waxing in the hot sun
ABS Panel	ABS plastic	Mild soapy water and wax	As needed	
Fire Extinguisher		Check for charge prior to each camping trip; note directions on extinguisher		
Floor Covering	Tarkett vinyl	Clean with water and mild soap	As needed	Abrasive cleaners
Frame	Painted steel	Rinse with water after salt or chemical contact; touch up bare spots	As needed	Chemical contact
Furnace	12,000 BTU Hydro Flame 20,000 BTU Hydro Flame	See furnace manual		
Gas Bottle		See "Gas System"		
Gas Hose	Rubber	See "Gas System"		
Gas Line	Copper	See "Gas System"		
Lift Assemblies	Stainless steel	See pages 34-35 of this manual		
Lug Bolts/Nuts	13/16"	70 Footpounds for 8" 85 Footpounds for 10"	Before each trip	
Mattress Covers	Herculon/Olefin	Vacuum; foam-type cleaners	As needed	Grease, oil, excessive heat
Outside stove	Coleman propane	Warm soapy solution for cleaning; do not leave open without brace in position; do not leave unattended		Leaving unattended; applying excessive weight to shelf
Pigtail	Six-wire	Inspect for cuts, breaks, or dirt	Prior to each use	Cutting, dirt
Pulleys		See "Lift System"		
Pump (Electric)	Shurflo	See separate manual with trailer		Operating w/empty tank; clogged filter
Pump (Hand)	Leisure Components	Lubricate pump lever with mineral oil	Once a year	Freezing with water in line
Ratchet		See "Lift System"		
Screen Door	Aluminum	Wash with water and apply quality auto wax	As needed	Abrasive cleaners

MAINTENANCE

COMPONENT	IDENTIFICATION	STANDARD CARE	FREQUENCY	AVOID
Stabilizer	Atwood (650 lbs)	Keep free of dirt; lubricate with silicone	As needed	Dirt buildup
Swing-level Galley	Americana series only	Silicone lubricate and proper adjustment	As needed	Overloading, dropping or lifting in areas other than indicated
Table	5/8" Particle board	Clean with damp cloth	As needed	Direct heat; excessive exposure to elements
Tires	Goodyear	See specifications		Under- or over- inflation
Tongue Jack	Atwood (500 lbs.)	Position handle properly while traveling; lubricate with light oil	Once a year	Salt and chemical contact
Top Assembly Exterior	Aluminum sandwich panel	Wash as needed; inspect for voids in caulking	Check caulking once per season	Abrasive cleaners; excessive weight
Interior	Vinyl luan	Clean with water and mild soap solution	As needed	Abrasive and sharp instruments
Vinyl Windows	Clear vinyl	Warm water and mild detergent	As needed	Abrasives and storing wet
Water Heater	Atwood (6 gallon)	See page 28 of this manual		
Water Tank	Polyethylene	See "Water System"		
Wheel Covers	Plastic	Warm water and mild detergent	As needed	Excessive prying or impact

LIMITED WARRANTY

1990 COLEMAN CAMPING TRAILER

1. Your new Coleman Camping Trailer is warranted to the original retail consumer for one year from the date of retail purchase to be free from defects in material and workmanship. This warranty is not transferrable.
- 2A. The lift system (used to raise and lower the roof) is warranted to the original retail consumer for his or her lifetime against functional defects in material and workmanship. This warranty covers parts and labor for the first three years and parts only thereafter with the following exclusions:
 - i. Normal adjustments to the lift system (such as periodic roof height adjustment to compensate for stretch in cables) are covered for the first year of this warranty only.
 - ii. The installation of a roof air conditioner and/or any other roof-mounted accessories cannot exceed 150 pounds. Exceeding this limit voids the warranty provision on the lift system.
 - iii. Normal use, wear and tear, and excessive exposure to the elements.
 - iv. Any damage resulting from alterations to the lift system.
 - v. Any damage caused by improper routine maintenance or improper repair or by use of improper repair parts.
- 2B. The floor is warranted to the original retail consumer for his or her lifetime against functional defects in material and workmanship. The warranty on the vinyl floor covering is found in section 7.8 of this warranty. Parts and labor under this paragraph are covered for the first three years; parts only are covered thereafter.
- 2C. The steel frame is warranted to the original retail consumer for his or her lifetime against functional defects in material and workmanship. This lifetime provision does not include the surface finish of the frame. Parts and labor under this paragraph are covered for the first three years; parts only are covered thereafter.
- 2D. The roof of this camping trailer is warranted to the original retail consumer for five years from the date of retail purchase against functional defects in material or workmanship. Parts and labor under this paragraph are covered for the first three years; parts only are covered for the fourth and fifth years.
- 2E. The warranty of paragraphs 2A through 2D is not transferrable and is limited to functional defects.
3. Return within ten days of retail purchase of the Warranty Registration Form provided with the Camping Trailer is a requirement to obtain warranty performance. The Warranty Registration Form will also permit Coleman to locate consumers in the unlikely event of a product safety recall. Coleman will send the customer an owner's card that reflects the warranty data for the trailer.
4. During the specified times, any defective parts in a Coleman Trailer will, at Coleman's option, be either repaired or replaced on an exchange basis with new or reconditioned parts. This Warranty does not cover the expense to take the Camping Trailer to the dealer for repair, nor the return expense. The consumer must pay all expenses incurred in obtaining warranty performance other than those specifically provided for in this Warranty.

5. The date of retail sale is established by the Warranty Registration. Replacement parts are warranted for the unexpired duration of the original warranty.

6. To obtain warranty performance:

6.1 Consult the yellow pages of the telephone book under "Trailers - Camping and Travel" for the name, address, and telephone number of the nearest authorized Coleman Camping Trailer Dealer; or call Coleman at 814/445-9661. (Collect calls will not be accepted.) Call the authorized Coleman Camping Trailer Dealer, report the problem and schedule an appointment. Take the trailer at the scheduled time to the dealer along with the owner's card sent to you by Coleman. Only authorized Coleman Camping Trailer Dealers may perform warranty obligations.

6.2 The authorized Coleman Camping Trailer Dealer will advise when the warranty performance has been completed. All payments for warranty service and for parts will be made by Coleman to the dealer and not to the consumer.

General Exceptions and Exclusions

7. To the extent any or all of the following exclusions or provisions of this warranty are prohibited by any federal, state, or municipal law which cannot be preempted, those exclusions or provisions shall not be applicable.

7.1 THERE ARE NO OTHER EXPRESS WARRANTIES EXCEPT AS SET OUT ABOVE AND ANY IMPLIED WARRANTIES, INCLUDING THE IMPLIED WARRANTIES OF MERCHANTABILITY AND FITNESS FOR A PARTICULAR PURPOSE, ARE LIMITED IN DURATION TO THAT OF THE EXPRESS WARRANTY. Some states do not allow limitations on how long an implied warranty lasts, so the above limitation may not apply to you.

7.2 THIS WARRANTY DOES NOT COVER CONSEQUENTIAL DAMAGES, INCIDENTAL DAMAGES, OR INCIDENTAL EXPENSES, INCLUDING DAMAGE TO PROPERTY. Some states do not allow the exclusion or limitation of incidental or consequential damages, so the above limitation or exclusion may not apply to you.

7.3 This warranty does not cover damages caused by failure to perform normal and routine maintenance as set out in the Camping Trailer Owner's Manual.

7.4 This warranty does not cover damage caused by mishandling, neglect, abuse, misuse, lightning, or corrosive atmospheres.

7.5 This warranty shall not apply if the serial number plate is removed or defaced.

7.6 The tent material is not warranted against fading, discoloration, soiling, or problems resulting from misuse or abuse. Ripped or torn tents will be repaired or replaced at Coleman's sole discretion through an authorized Coleman Camping Trailer Dealer, provided the rips or tears are noted prior to retail delivery.

7.7 Top assemblies are warranted only for functional defects such as leaks. Any nonfunctional or cosmetic problems that are not noted prior to retail delivery are not covered by this warranty.

7.8 The vinyl floor covering is warranted for gouges, cuts, or tears only if noted prior to retail delivery. Such damage noted prior to delivery shall be remedied by repair or replacement at Coleman's sole discretion.

7.9 The lightbulbs, fuses, tire valve cores, and other similar items are not covered by this warranty and are sold AS IS.

7.10 The tires, water heater, electric water pump, porta potti, furnace, and refrigerator in trailers so equipped are warranted by their respective manufacturers. A copy of the warranty for each of these components is provided with the Camping Trailer.

7.11 Trailers used for rental purposes are covered by this warranty for three (3) months from the date of purchase by the rental dealer; or if rented by an authorized Coleman Camping Trailer Dealer, from the date of rental registration.

7.12 This warranty applies only to products sold at retail in the United States and Canada.

8. The Coleman Company reserves the right to make changes in the design or material of its products without incurring any obligation to incorporate such changes in any product previously manufactured.

9. This warranty gives you specific legal rights, and you may also have other rights which vary from state to state.

CHANGE OF OWNERSHIP NOTIFICATION

MODEL INFORMATION

YR. _____ MODEL _____

SERIAL NUMBER _____

NEW OWNER INFORMATION

PURCHASE
DATE _____

NAME _____

ADDRESS _____

CITY _____

STATE/PROVINCE _____ ZIP _____

PREVIOUS OWNER INFORMATION

PURCHASE
DATE _____

NAME _____

ADDRESS _____

CITY _____

STATE/PROVINCE _____ ZIP _____

NOTE:

This card is to be completed and sent to the Coleman Company Inc. ONLY after the original retail purchaser transfers ownership of the trailer to another party.

NOTICE TO DEALER AND CONSUMER

Because brake requirements are governed by state or provincial regulation, the requirements vary from state to state. To insure compliance with applicable regulations, we recommend you check with your Department of Motor Vehicles to determine if brakes are required on your trailer. The weight specifications in the owner's manual will assist you in making this determination. Available through your dealer is an accessory electric brake package which can be installed on your trailer without any problem.



NO POSTAGE
NECESSARY
IF MAILED
IN THE
UNITED STATES

BUSINESS REPLY MAIL

FIRST CLASS PERMIT NO. 83 SOMERSET, PA 15501

POSTAGE WILL BE PAID BY ADDRESSEE

THE COLEMAN COMPANY, INC.
Camping Trailer Division
P.O. Box 111
Somerset, PA 15501-9985

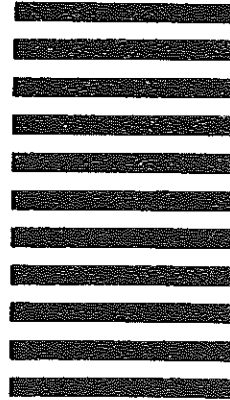

ATTN: Warranty Service Dept.



THE COLEMAN COMPANY, INC.
CAMPING TRAILER DIVISION
SOMERSET, PENNSYLVANIA 15501-0111