

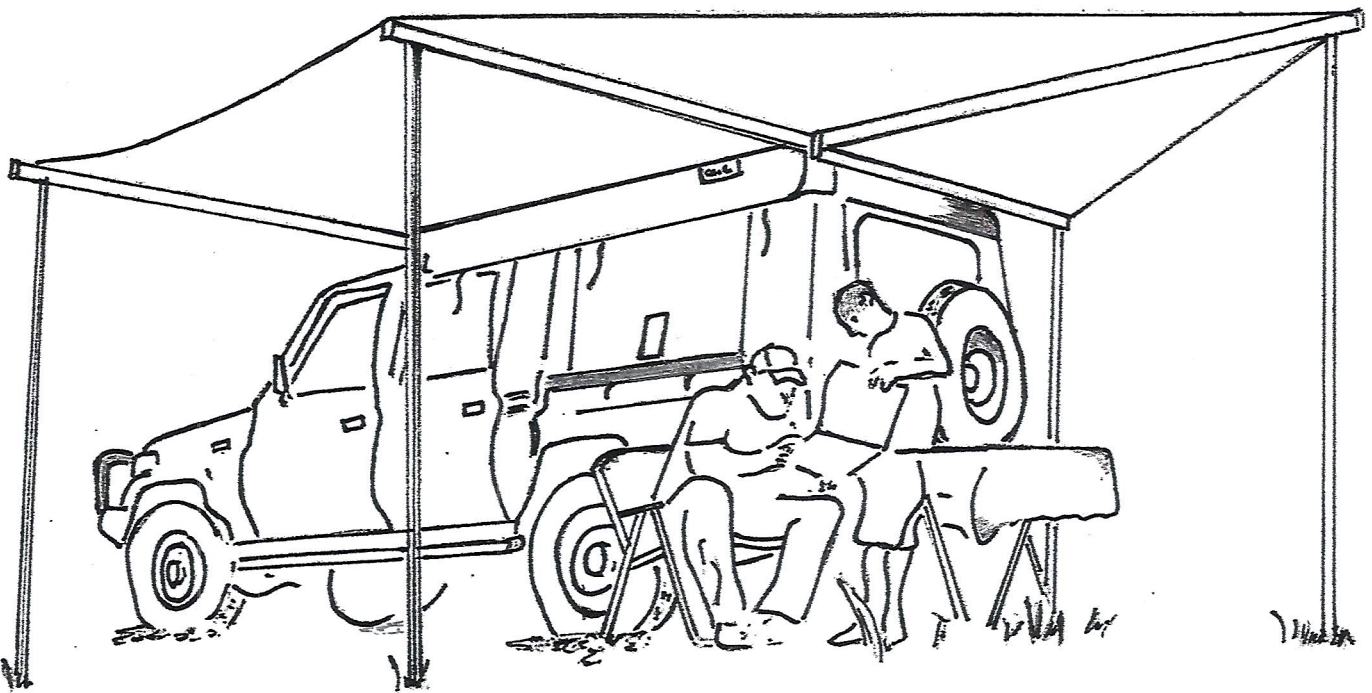

P.O. Box 68323, Bryanston 2021.
200 Cussonia Park, 3 Ridge Road,
Laser Park, Honeydew, South Africa.
Tel: (011) 794-6311 • Fax: (011) 794-6233

OPERATING INSTRUCTIONS



HELPFUL HINTS

1. Periodically clean the fabric with water. (Let the fabric dry before rolling it up. This also helps prevent mildew.)
Cleaning is especially important prior to storing the awning for long periods of time to prevent mildew and stains.
2. Use paraffin wax on Support Arms and Rafter Arms for smoother sliding movement.

TO OPEN

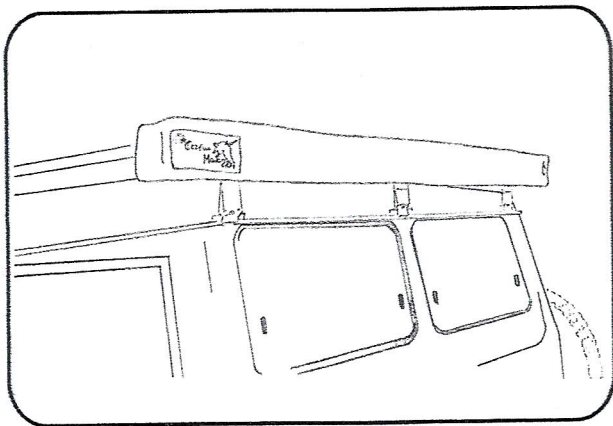

MANTA in closed position:

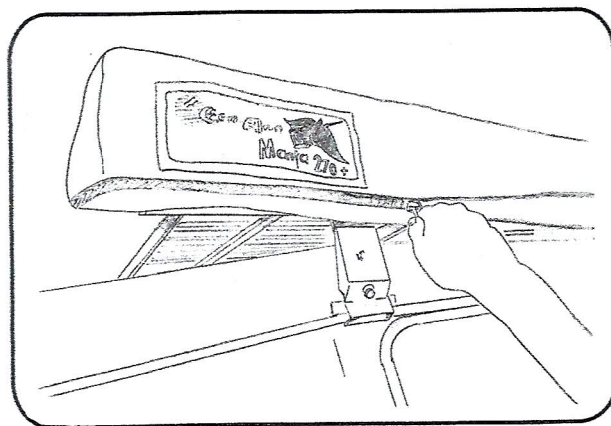

Unzip bag in order to open the MANTA.

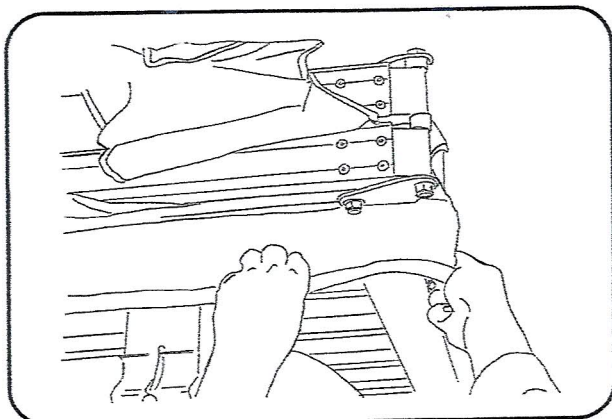

Fold bag back on the hinge side first

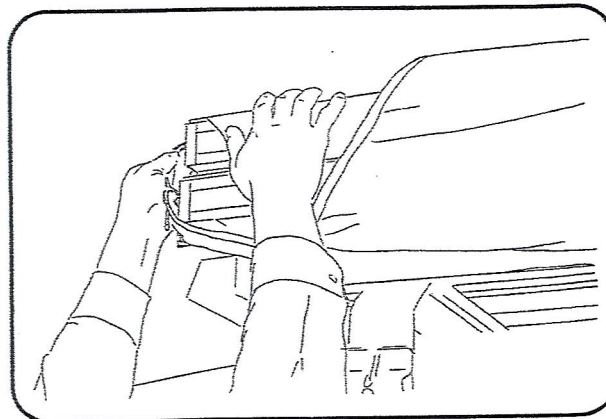

Fold bag back on profile side and loosen retaining strap

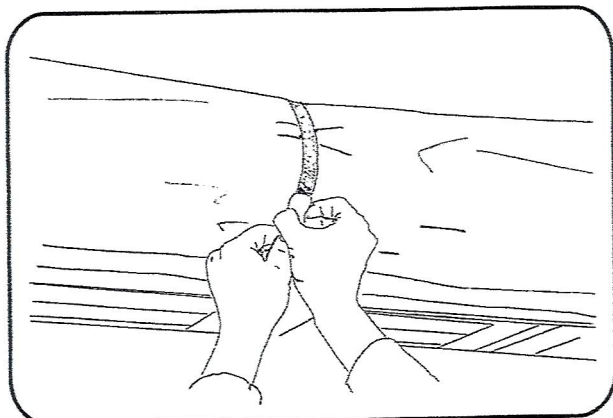

Undo all plastic clips that are retaining fabric in place

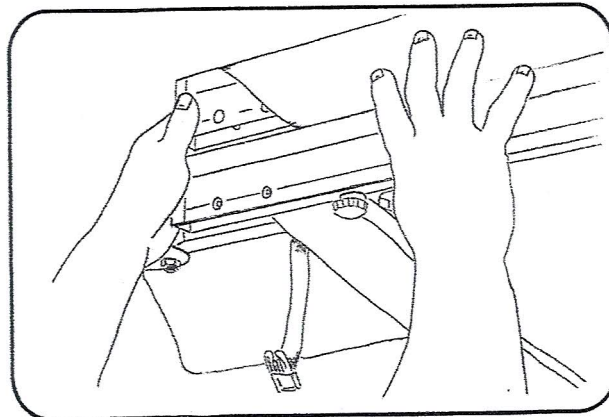

Take hold of aluminium profile

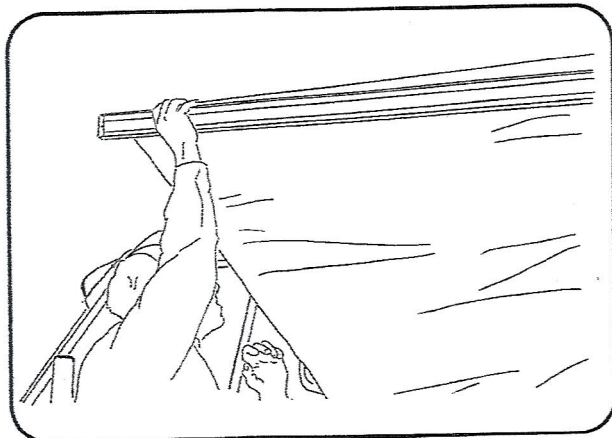

Pull on aluminium profile to release MANTA.

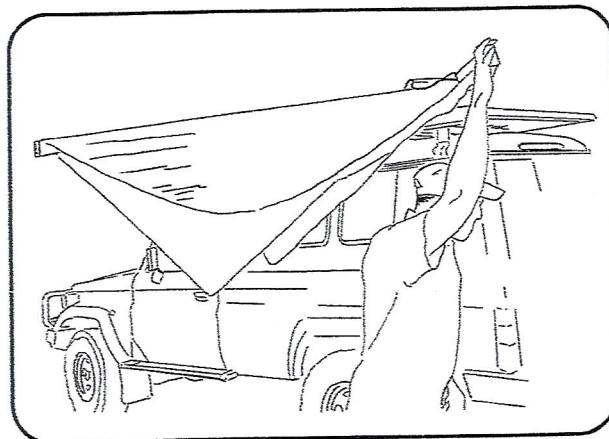

Walk the profile in your hand in order to deploy the MANTA.

TO OPEN

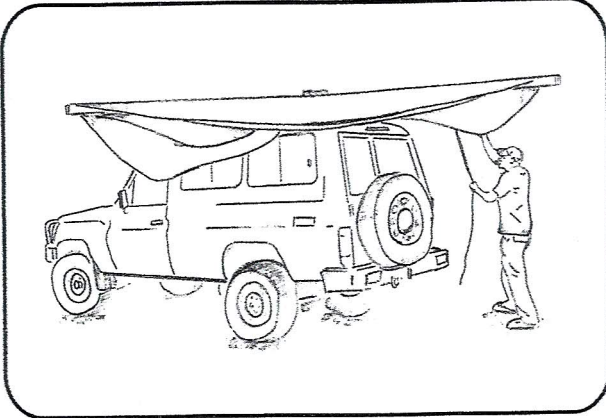

MANTA in semi open position:



Secure strap provided to your roofrack or bars and then adjust one end by pulling on strap.

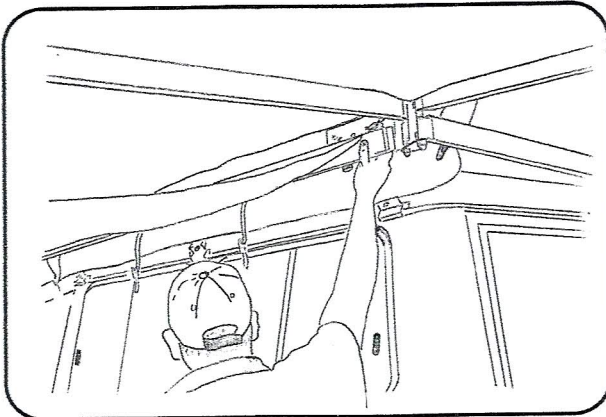

Lift outer arm off securing bracket.

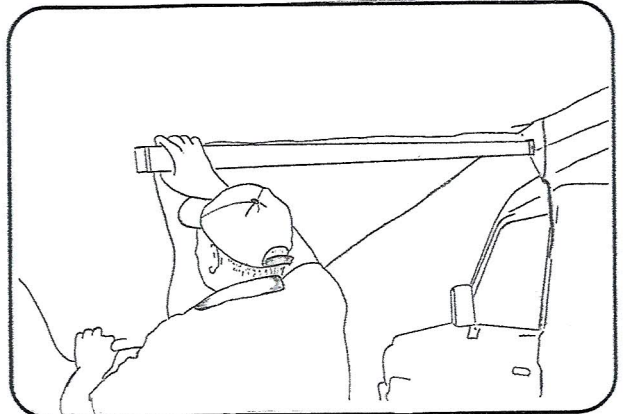

Walk with profile in order to deploy.

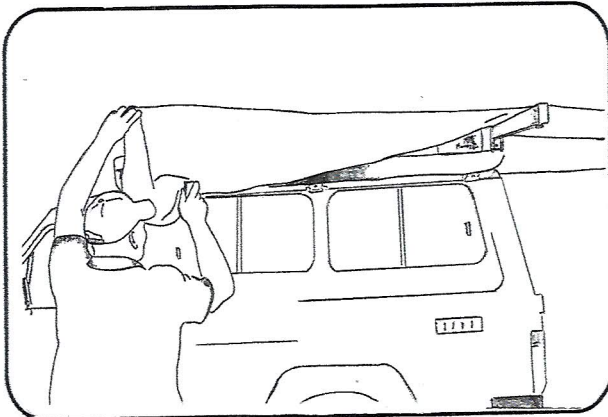

Use one hand to help lift fabric over outer arm.

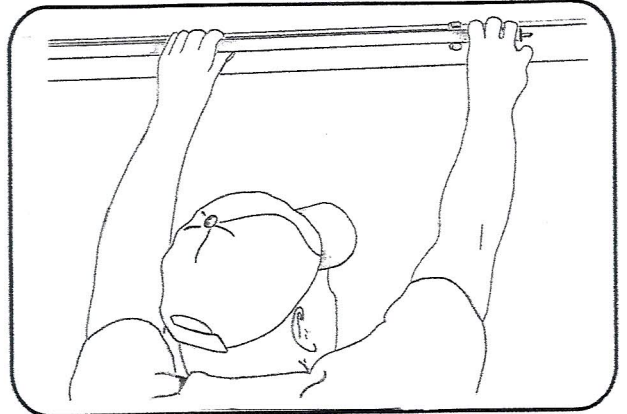

Unclip tension pole.

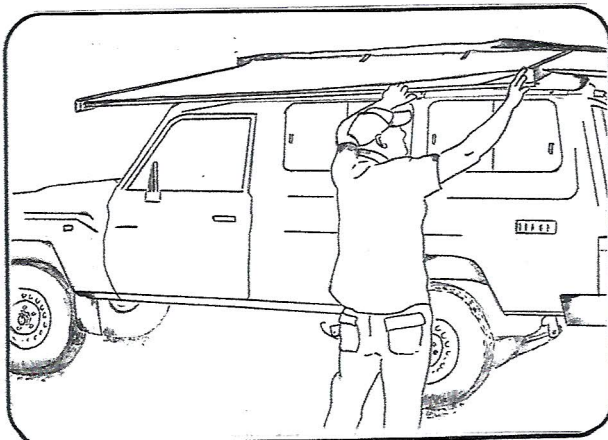

Swivel tension pole into position.

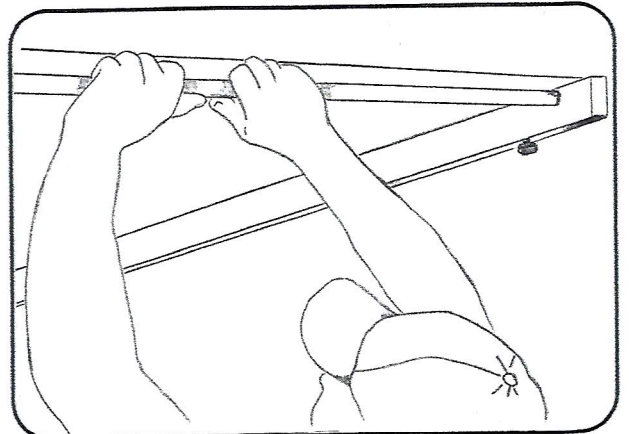

Place pole nib into hole on arm and twist lock to secure.

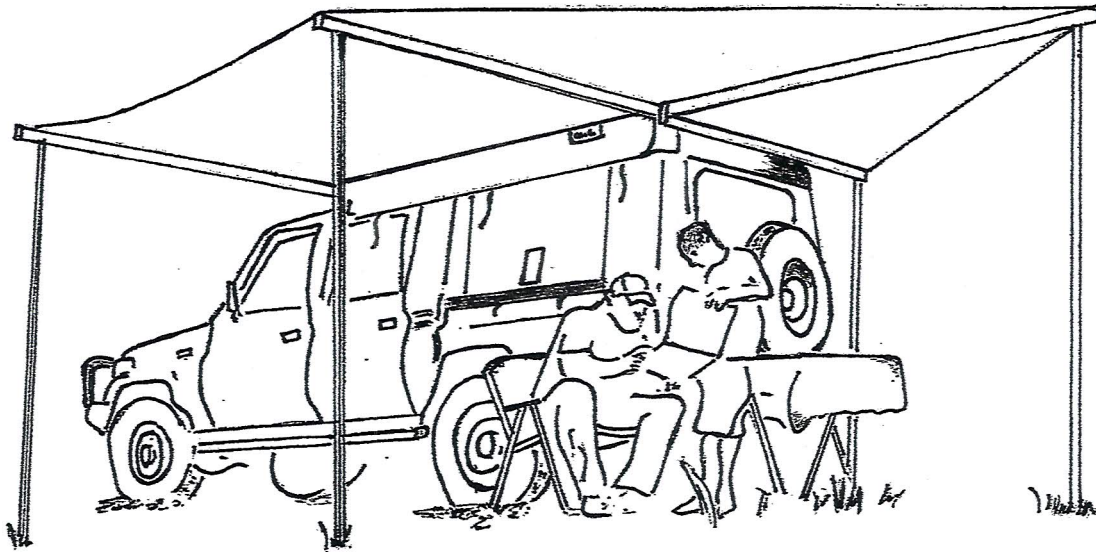

Legs must be deployed and anchored in wind and rain

TO CLOSE

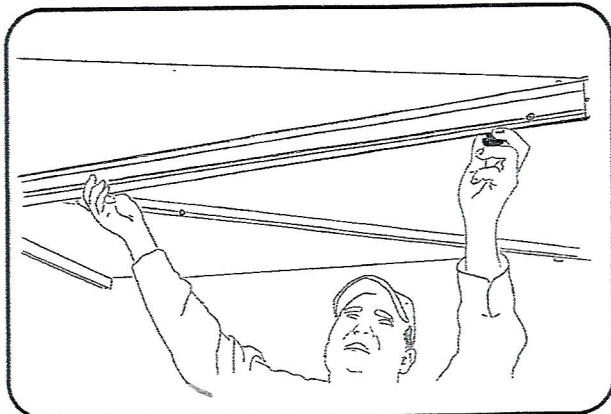

Replace awning legs back into aluminium profile.

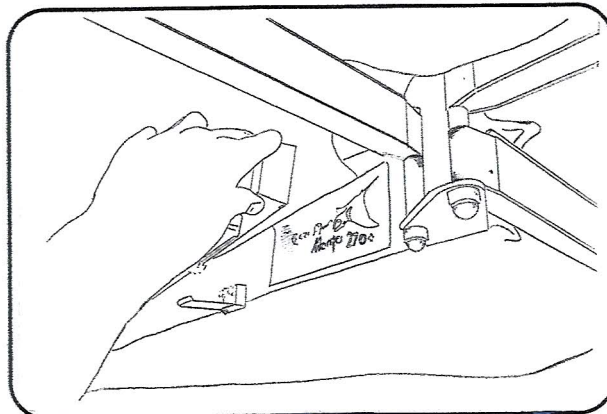

Place outer arm first back onto securing bracket.

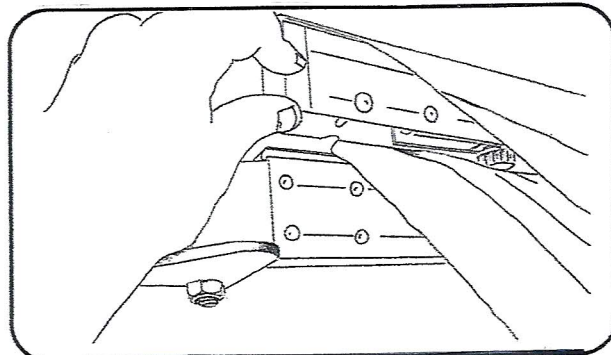

Fold aluminium profiles back into storage position - help guide them so that they sit on top of one another and secure with strap provided

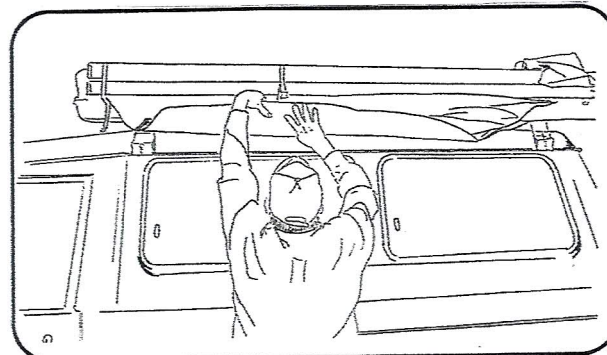

Roll fabric back up and secure with strap provided

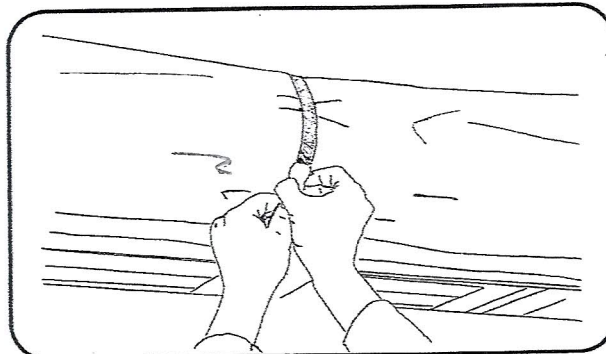

Secure fabric with strap provided

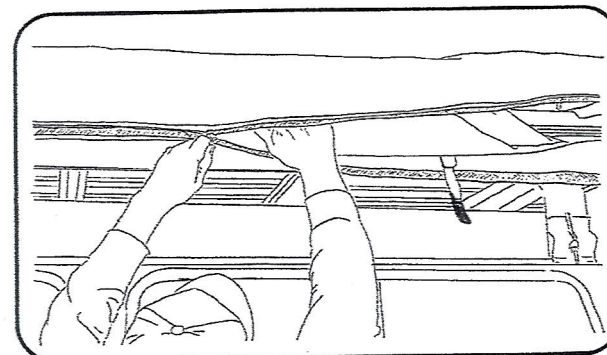

Help with one hand to push fabric in place and close zip



INSTALLATION

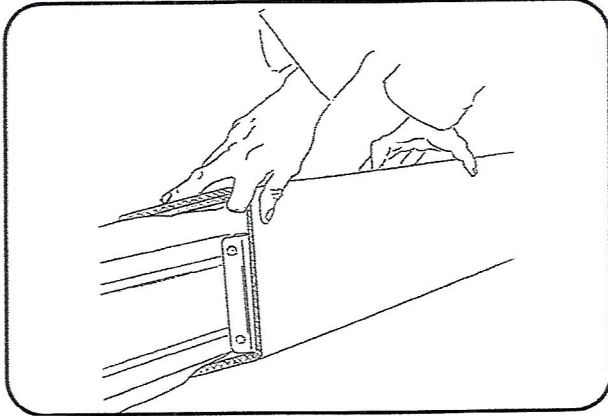

Remove MANTA from its packaging and place it face down.

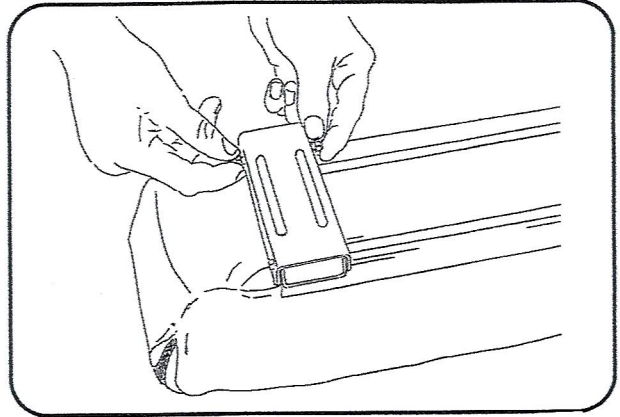

Undo top bracket of kit provided.

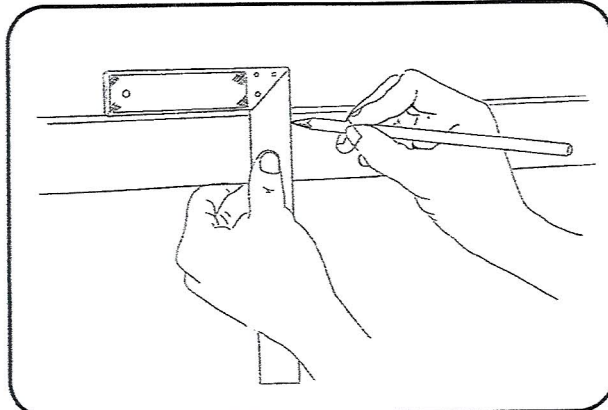

By using a set square, draw a straight line where you would like to mount the front kit to the roofrack

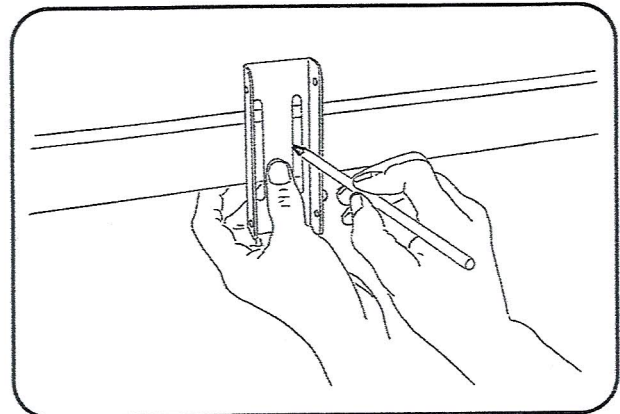

Place the kit into position and mark the holes on the roofrack

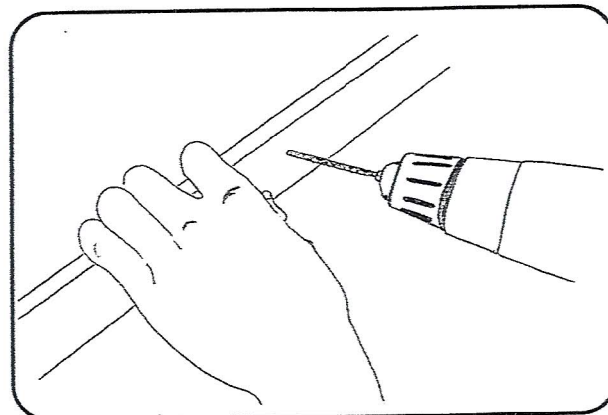

Drill holes in rack by using a 6,5mm drill bit.

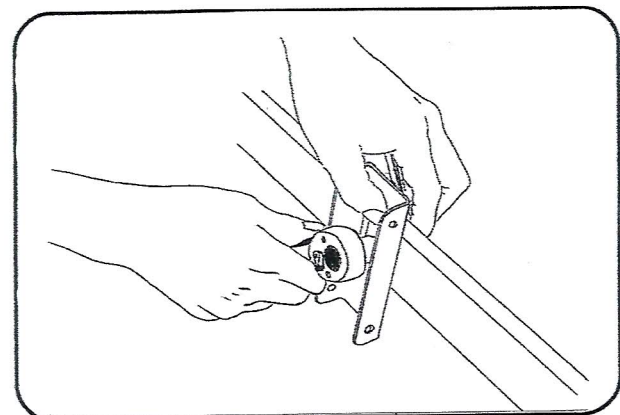

Secure brackets with bolts.



INSTALLATION

Optional extra K9 Roofrack L bracket kit
no drilling required.

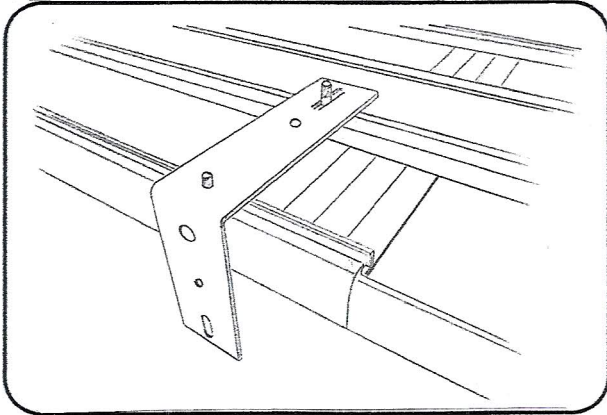

Slide bolts into K9 rack and position L bracket.

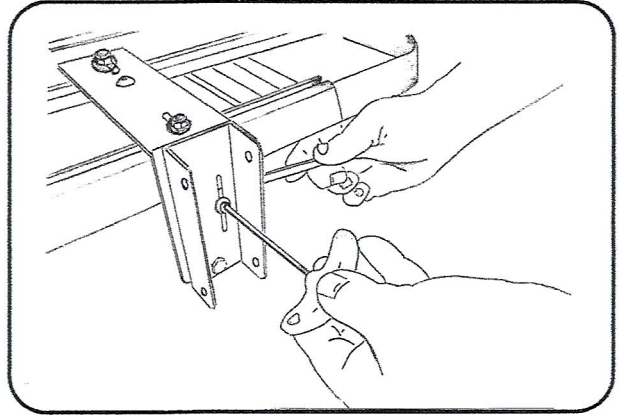

Secure L bracket, gusset in position and tighten with bolts provided.

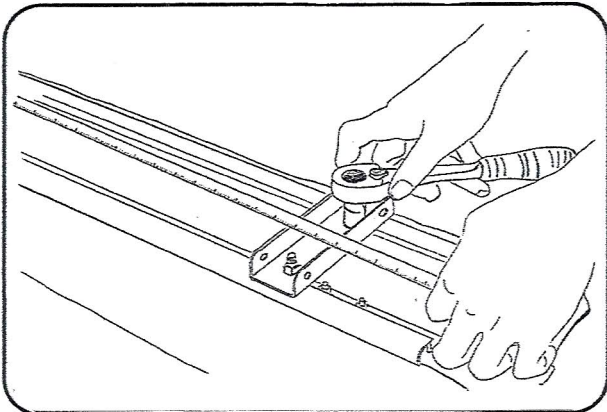

Use a measuring tape to align kits to a MANTA 270 with the ones you have fitted to your roofrack. Do this by loosening the bolts on the kit. The kit on the hinge side of the MANTA should never be more than 300mm from the edge. Hold the MANTA in position and bolt the kits together.

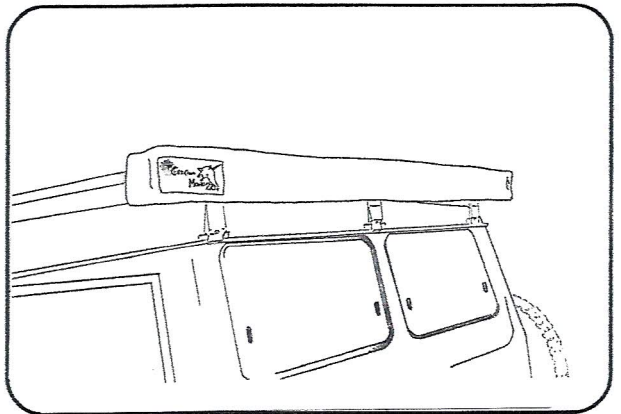
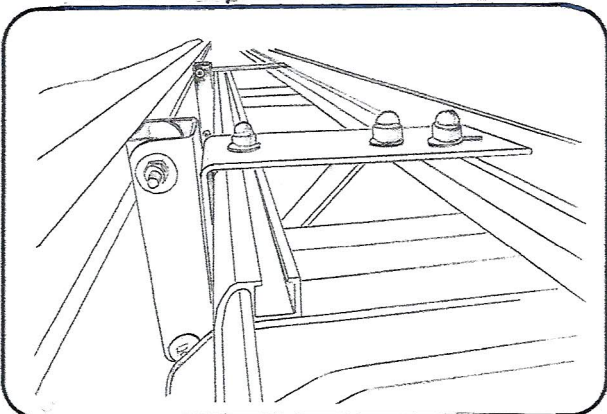
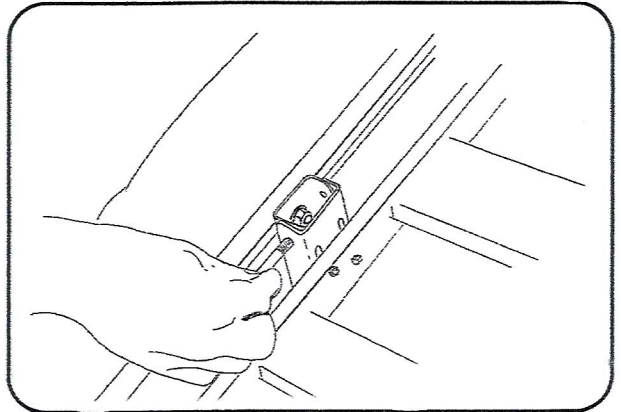

JOB WELL DONE!