

For The Long Run[®]

WOODWAY[®]

Non-Motorized Treadmills

User Manual: 02/2018, UM-NT-EN-02

Includes manuals for models:

Curve

Curve 1.5

Curve 3.0

Curve Trainer

Curve XL

EcoMill

Curve FTG



Be Green. Run Clean.[®]



WOODWAY

European Representative

WOODWAY GmbH
Steinackerstr. 20
79576 Weil am Rhein
Germany
Tel.: + 49 (0) 7621-940 999-0
Fax.: + 49 (0) 7621-940 999-40
E-mail: info@WOODWAY.de
Web: www.WOODWAY.de

Manufacturer

WOODWAY USA, Inc.
W229 N591 Foster Ct.
Waukesha, WI 53186
USA
Tel.: 1-262-548-6235
Fax.: 1-262-522-6235
E-mail: info@WOODWAY.com
Web: www.WOODWAY.com

MY WOODWAY: _____ **ARRIVED:** _____

WOODWAY History

WOODWAY's history began in Germany in 1974. Willi Schoenberger, a technical director in charge of planning a fitness center, noticed that the most important piece of equipment, the treadmill, did not meet the most important requirements: a mechanically sound machine that is designed to meet human needs.

He envisioned a comfortable surface that did not interfere with the natural biomechanics of running or walking. Also, he wanted to design a transportation system which eliminated the friction associated with the conventional (conveyor belt) treadmills. After intensive research, and trial and error (and in cooperation with the Deutsche Sporthochschule in Koln, Germany), Willi developed and patented a very unique and revolutionary treadmill design.

In 1975, WOODWAY GMBH was founded in Weil am Rhein, Germany. The name "WOODWAY" is derived from the German "wald weg" or "way of the woods" – the feel of running on a soft pine needle covered path in the forest.

In 1983, a manufacturing license was awarded to Sakai Medical, for the use of WOODWAY technology in the Japanese marketplace.

In 1988, a U.S. license was granted to a small, but well-established manufacturing company in Waukesha, Wisconsin. WOODWAY USA was formed when the U.S. incarnation of the WOODWAY was developed and completed in 1990. WOODWAY USA is very proud to be the primary manufacturer of WOODWAY Treadmills worldwide, exporting treadmills each month to Germany and Japan for international distribution, in addition to serving our domestic customers and clients.

Today, WOODWAY's design and manufacturing facilities in the United States, Germany and Japan make WOODWAY the largest specialized treadmill manufacturer in the world. Constant enhancements in quality, design and function are shared and implemented by all three WOODWAY manufacturers.

Table of Contents

1	<i>Safety</i>	8
1.1	Important Safety Instructions	8
1.2	Description of Warning Notes	10
1.2.1	Sample of a Warning Notice	10
1.2.2	Classification	10
1.3	Safety Notices on Devices	11
1.4	Health Risks	13
1.5	Unauthorized Modes of Operation	14
2	<i>Introduction</i>	16
2.1	Operating Instructions Information	16
2.1.1	Observe the Instructions	16
2.2	Limitation of Liability	17
2.3	Copyright	17
2.4	Replacement Parts	17
2.4.1	Disposal.....	17
2.5	Customer Service	18
2.5.1	Servicing.....	18
3	<i>Technical Data</i>	19
3.1	Name Plate	19
3.1.1	Keep Handy for Questions.....	19
3.2	Technical Specifications	20
3.3	Power Requirements	22
3.3.1	Curve / Curve Trainer/ Curve XL.....	22
3.3.2	Curve/Trainer Prosmart and FTG.....	22
3.3.3	EcoMill	25
3.4	Dimensions	26
3.4.1	Curve.....	26
3.4.2	Curve Trainer	26
3.4.3	Curve XL	27
3.4.4	EcoMill	28
	28
3.4.5	FTG.....	28
4	<i>Transportation and Storage</i>	29
4.1	Safety Notices for Transportation	29
4.1.1	WOODWAY Service	29

4.2	Transporting the Treadmill	30
4.2.1	Carrying Tubes.....	30
4.2.2	Transport Rollers.....	30
4.3	Storage	30
5	Product Description	31
5.1	Function	31
5.2	Running Surface	32
5.2.1	Slat Design.....	32
5.3	Transport System	32
5.3.1	Bearing Rails.....	32
5.3.2	Side Belts.....	32
5.3.3	Load Distribution.....	32
6	Setup and Installation	33
6.1	General	33
6.2	Installation	33
6.3	Assembly Instructions	34
6.3.1	Positioning the Device.....	34
6.3.2	Mount the CURVE Display Screen to the Handrail.....	35
6.3.3	Mounting the Handrails.....	37
6.3.4	Mounting the Side Panels.....	44
7	Operation	70
7.1	For Your Safety	70
7.2	Safety Equipment	72
7.2.1	Controlled Start Speed (ECOMILL).....	72
7.2.2	Emergency Stop with Pull Cord (ECOMILL).....	72
7.2.3	Single Direction Motion.....	73
7.2.4	Only Forward Movement.....	73
7.2.5	Safety Railing.....	73
7.3	Practical Training	74
7.3.1	Professional Consultants.....	74
7.3.2	Warm-Up and Cool Down.....	74
7.3.3	Proper Body Form.....	74
7.3.4	Measuring Heart Rate.....	74
7.3.5	Calculating Maximum Heart Rate.....	75
7.3.6	Heart Rate Recommendation.....	75
7.3.7	Training Frequency.....	75
7.3.8	Endurance Training.....	75
7.3.9	Running Shoes.....	75
7.3.10	Heart Rate Chart.....	76
7.3.11	Contact Heart Rate Measurement (ECOMILL).....	76

7.4	Heart Rate Monitor	77
7.4.1	Applying the Chest Strap	77
7.5	Display Curve	79
7.5.1	Curve and Curve Trainer.....	79
7.5.2	Curve FTG	81
7.5.3	Curve, Curve trainer, Curve FTG Prosmart	82
7.5.4	Curve XL, Curve 1.5 and Curve 3.0.....	82
7.6	Display ECOMILL	84
7.6.1	Display Parameters	84
7.6.2	Description of Display Elements.....	85
7.6.3	Function Key Description	86
7.7	CURVE 1.5 Program	87
7.7.1	Description of Display Elements.....	87
7.7.2	Stop Workout Markers	88
7.7.3	Manual Workout	88
7.8	Manage User(s)	89
7.8.2	Custom Programs	91
7.8.3	Results	96
7.8.4	Generate Report.....	97
7.8.5	Pacer Function	100
7.8.6	Change Settings	101
7.9	CURVE 3.0 Program	103
7.9.1	Introduction	103
7.10	Program Views	104
7.10.1	Dashboard.....	105
7.10.2	Program Designer	107
7.10.3	Graphs	109
7.10.4	Report.....	109
7.10.5	Options.....	109
7.10.6	Settings.....	110
7.10.7	Data Collection	110
7.10.8	Calibration.....	112
7.10.9	Calibrating Vertical Force	113
8	<i>Accessories and Services</i>	114
9	<i>Cleaning and Maintenance</i>	115
9.1	Cleaning	115
9.2	Instructions	115
9.3	Maintenance	116
9.3.1	Weekly Maintenance	116
9.3.2	Annual Maintenance.....	116
9.4	Lubrication	117

- 9.4.1 Bearings.....117
- 9.4.2 Running Surface Belt134117
- 10 Warranty Information 118**
- 11 Troubleshooting..... 119**
 - 11.1 Display Will Not Turn On 119
 - 11.2 Running Surface Belt is Stuck/Difficult to Move 119
 - 11.3 Squeaking Sounds 119
- 12 Maintenance Report 120**
- 13 Disposal Notice..... 121**
 - 13.1 Batteries..... 121
 - 13.2 Device..... 121

1 Safety

1.1 Important Safety Instructions

SAVE THESE INSTRUCTIONS

The treadmill has been reliably designed, manufactured, and tested per the latest state of technology and is in safe and technically perfect condition. Never the-less, the device can cause risk to persons and property if operated improperly.

For this reason, the operating instructions should be read completely and safety instructions must be observed.

Warnings attached directly to the device must be observed and kept in a legible condition.

Inappropriate use will result in the rejection of any liability or guarantee claims by WOODWAY.

A safety sign has been included with your treadmill. It is the responsibility of the owner to post this sign in a visible area near the machine.

All WOODWAY treadmills are built to the specifications of and are intended for both commercial and residential use.

READ ALL INSTRUCTIONS BEFORE USING THE TREADMILL

DANGER: To reduce the risk of electrical shock

1. Do not operate the heart rate monitor transmitter in conjunction with an electrical heart pacemaker. The transmitter may cause electrical disturbances.
2. Do not soak the treadmill surfaces with any liquid; use a sprayer or damp cloth.
3. Do not place any open liquid containers on any part of the treadmill. The use of sport bottles with closeable tops is acceptable.
4. Do not attempt to service your treadmill yourself without first contacting WOODWAY Service.
5. Always keep the running surface clean and clear of obstructions.

CAUTION:

1. Consult your physician before beginning any exercise program, especially if any of the following pertain to you: history of heart disease, high blood pressure, diabetes, chronic respiratory disease, elevated cholesterol, smoker, experiencing any other chronic disease or physical impairments.
2. Pregnant women should consult their physician before beginning an exercise program.
3. If you experience dizziness, chest pain, nausea, or any other abnormal symptoms while using the treadmill, stop training immediately. Consult a physician before continuing.
4. A qualified mechanic should perform any service or repair work. It is preferable that mechanics have successfully completed WOODWAY factory-authorized service school or equivalent.

WARNING: To reduce the risk of injury to you and to others.

1. The treadmill is non-motorized. The user controls the speed, including the rate at which the treadmill slows or comes to a stop. There is no motor on the treadmill, therefore there is no emergency stop pull cord or lanyard. The treadmill will come to a stop on its own. It is imperative that all users familiarize themselves with the treadmill and its features.
2. The belt moves freely- always mount and dismount the treadmill from the rear of the treadmill. Use the handrails always when mounting and dismounting from the rear.
3. Set up and operate the treadmill on a solid, level surface.
4. Keep all loose clothing and towels away from the running surface. It is also important that shoe laces do not extend beyond the bottom of the shoe.
5. Keep the area behind treadmill clear and at least 78" (2 m) from walls or furniture.
6. Keep hands away from all moving parts.
7. Never leave children unsupervised while on or near the treadmill.
8. Inspect the treadmill for worn or loose components prior to use. Tighten or re-place any worn or loose components prior to use. Read, understand, and test all emergency stop procedures.
9. WOODWAY treadmills are built to handle runners weighing up to 800 lbs. (360 kg) at speeds between 0-4 MPH (0-6.5 km/h) and 400 lbs. (180 kg) at speeds up to 18 MPH (29 km/h).
10. The treadmill running belt might not stop immediately if an object becomes caught in the belt or rollers.
11. Care should be taken when mounting and dismounting the treadmill. Never mount or dismount the treadmill while the running belt is moving. Use the hand-rails whenever practical or necessary.
12. Wear proper athletic shoes with rubber or high-traction soles. Do not use shoes with heels or leather soles. Ensure no stones are embedded in the profile of the soles.
13. Allow several minutes to bring your heart rate into the training zone depicted in the manual. Walk slowly after your workout to allow your body sufficient time to cool down and your heart rate to decrease.
14. The safety and integrity designed for the machine can only be maintained when the treadmill is regularly examined for damage and/or wear and repaired if necessary. It is the sole responsibility of the user/owner or facility operator to ensure that regular maintenance is performed. Worn or damaged components should be replaced immediately or the treadmill should be removed from service until the repair is made. Only manufacturer-supplied or approved components should be used to maintain and repair the treadmill.

1.2 Description of Warning Notes



Warning notices indicate potential hazards or safety risks. They are indicated in this manual by a color-coded signal word panel (symbol with the appropriate signal word).

All warning notices have the same design and the same standardized content design.

1.2.1 Sample of a Warning Notice

 SIGNAL WORD
<p>Warning text, type, and source of danger:</p> <ul style="list-style-type: none"> Description of the consequences of ignoring the danger Measures, instructions, and forbidden actions to avoid the hazard Further measures

1.2.2 Classification

NOTE	NOTE (no danger symbol), No risk of injury, pertinent information and warning against material damage
 CAUTION	CAUTION (with danger symbol), Slight possibility of injury
 WARNING	WARNING (with danger symbol), In a dangerous situation, serious accident possible with the possibility of injury or death
 DANGER	DANGER (with danger symbol), In the event of an accident, immediate danger or death or serious injury

1.3 Safety Notices on Devices

Replace the safety stickers if they become damaged or illegible.

Information relevant to safety is identified on the device using the following stickers:



Use Care When Using the Non-Motorized Treadmill

Notice on free movement in the direction of the arrow, and on mounting and dismounting the treadmill is located on the back-right side panel (running direction).



Ensure Proper Health Condition Before Use

Consult a physician before use and discontinue training in case of health problems. This notice is located on the front left side panel (running direction).



Belt Tension Warning

To prevent incorrectly tensioning running belt and causing damage or injury, call WOODWAY for proper instruction or to set up an appointment with a service technician. This is located just inside the treadmill side covers.

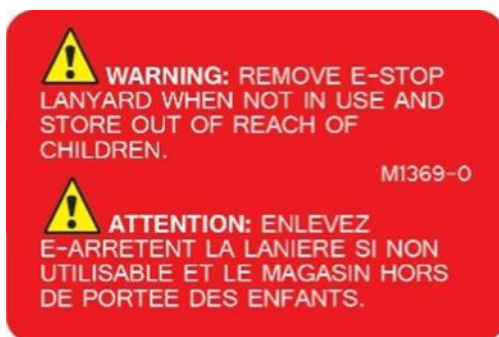

Store EMERGENCY OFF Magnet Out of Reach of Children (ECOMILL)

If the device is not in use, the EMERGENCY OFF magnet with safety line and clip are to be stored out of the reach of children.

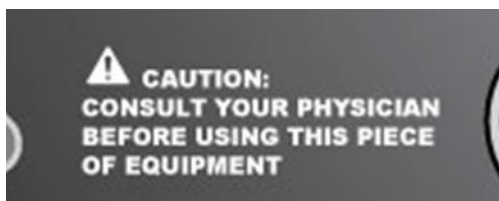

Before Using (ECOMILL)

Consult your physician or trainer before using the treadmill. This caution label is located on the bottom left of the ECOMILL display.



Secure EMERGENCY OFF Magnet (ECOMILL)

This is an information sign on mounting the EMERGENCY OFF magnets and for securing the safety line to the user. It is located on the bottom middle of the ECOMILL display.

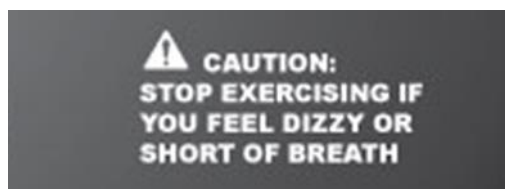

Stop Training if Dizzy or Out of Breath (ECOMILL)

Stop training if you do not feel well or are out of breath. This is located on the bottom right of the ECOMILL display.

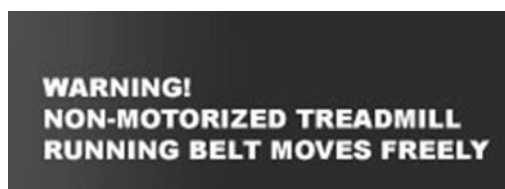

Non-Motorized Treadmill Running Belt Moves Freely (ECOMILL)

Notice on free movement of the treadmill running belt is located on the right of the ECOMILL display.

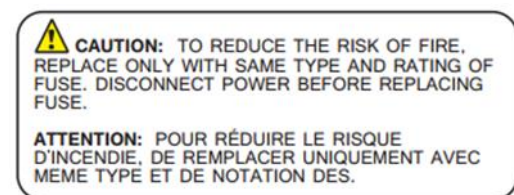

Safety Notice for Fuse Change

To prevent fire hazard, only replace fuses with the same type and power fuses. Remove the device from the mains before changing. This notice is located near the fuse inside the body of the treadmill.

1.4 Health Risks

 WARNING
<p>Health Hazards for Certain Groups of People</p> <p>The use of the non-motorized treadmill can pose health risks for certain people.</p> <ul style="list-style-type: none">• Before using the device, check the following list for limitations which may apply to you. If so, the specified measures must be adhered to

Before beginning an exercise program, consult your physician, especially if any of the following apply to you:

- History of heart disease
- High blood pressure
- Diabetes
- Chronic respiratory illness
- Elevated cholesterol levels
- Smoker
- Other chronic illnesses or physical impairments

Pregnant women must consult a physician before starting a training program.

Symptoms During Training:

Should you experience dizziness, chest pain, nausea, or any other abnormal symptoms while training on the treadmill, stop training immediately. Consult a physician prior to continuing training.

 WARNING
<p>Danger from Improper Use</p> <p>Any improper use and/or other use of the device can lead to dangerous situations with significant personal injury and/or property damage.</p> <ul style="list-style-type: none">• Only use the treadmill for its intended use.• Avoid excessive training, as this can lead to injury.• Read and strictly adhere to all information in the operating instructions.

The **Curve**, **Curve XL**, **Curve 1.5**, **Curve 3.0**, and **EcoMill** are non-motorized treadmills. They are intended for fitness training, to increase stamina and physical fitness, and can be used for running or walking.

The operating instructions are an integral part of the device and are to be available to all users at all times. The exact observance of the instructions is a prerequisite for the intended use of the WOODWAY device.



WARNING

Risk of Injury Through Risk of Falling

The free-running treadmill presents the danger of falling.

- Familiarize yourself with the treadmill operation and operating principles before the first training.
- Always use the safety handrail when mounting and dismounting and when starting training.
- Never leave children or animals near the treadmill unsupervised.

NOTE

Claims to the manufacturer of any kind due to damage from improper use are excluded.

The representative alone is liable for all damages resulting from improper use.

1.5 Unauthorized Modes of Operation

The treadmill may only be used for the intended use. Any additional uses may result in serious personal injury and/or property damage.

The following restrictions and prohibitions must be strictly adhered to:

- The non-motorized treadmills may not be used without prior instruction by qualified personnel.
- Children may not use the device or be left near the device unattended.
- The use of the treadmill under the influence of alcohol or drugs and/or narcotics is prohibited.
- The treadmill may not be used for animals.
- Walking surface is not suited for the use of running shoes with spikes or studs.
- It is forbidden to use the treadmill without its safety rail or with walking poles.
- The operation of the WOODWAY treadmill outside of the named ambient conditions in the section "Setup and Installation" (temperature, humidity, air pressure) as well as outdoors (i.e. outside of closed rooms) is not allowed.
- For people with health limitations or contraindications (see previous section), the use of the treadmill without prior consultation by a health care professional is prohibited.
- When stepping onto the treadmill, during exercises, and when stepping off the device, the safety instructions in this manual must be observed. Here, the following restrictions apply:
 - Never jump onto the treadmill.
 - Never jump off the treadmill.
 - Never enter the device from the front.
 - Never stop walking when the belt is moving.
 - Never turn around when the belt is moving.
 - Never walk sideways or backwards.



WARNING

Unauthorized Use Can Cause Injury

Using the non-motorized treadmill in a manner not authorized by WOODWAY can be potentially hazardous.

- Only use the treadmill for its intended use as described in the manual.
- Do not use unauthorized replacement parts or accessories that could interfere with the functionality or safety of the device.
- Always use the safety handrail when mounting and dismounting and when starting training.
- If the device is damaged or not functioning properly, do not use it until it has been inspected and/or repaired by qualified and authorized personnel.

2 Introduction

2.1 Operating Instructions Information

This manual provides information on the safe operation of the non-motorized treadmills. A condition for safe operation is compliance with all safety and operating instructions.

Read and Observe the Instructions

Read these instructions carefully before beginning any work on the treadmill. It is a part of the device and must be kept accessible at all times and in the immediate vicinity of the treadmill for operating and maintenance personnel.

CAUTION

Improper Operation Can Cause Accidents!

Not using the treadmill as intended according to the manufacturer's instructions can cause accidents and equipment damage.

- These and the operating instructions must be completely read and understood before using the treadmill.
- Keep these instructions close at hand for all users of the device.

2.1.1 Observe the Instructions

WOODWAY accepts no liability for accidents, equipment damage, and consequences of equipment failure that are a result of failure to follow the operating instructions. In addition, local accident prevention regulations and general safety conditions for intended use of the treadmill apply.

The manufacturer reserves the right to make technical changes in the context of improving the performance properties and further development without prior notice. Illustrations are for basic understanding and may differ from the actual design of the device.

Accessories from other suppliers have further safety regulations and guidelines which must also be observed. WOODWAY accepts no liability for accidents, equipment damage, and personal injury caused using accessories from other suppliers.

2.2 Limitation of Liability

All information and instructions in this manual have been compiled in accordance with applicable standards and regulations, the current state of technology, and our knowledge and experience. WOODWAY accepts no responsibility for damages resulting from:

- Disregarding the operating instructions
- Improper use
- Use by non-authorized persons
- Use of replacement parts which were not approved by WOODWAY
- Unauthorized modifications to the device or accessories

WOODWAY general terms and conditions and delivery conditions apply, as well as the legal regulations valid at the time of contract conclusion.

2.3 Copyright

The release of the operating instructions to third parties without the written permission of WOODWAY is prohibited.

***Note:** Claims to the manufacturer of any kind due to damage from improper use of any kind are excluded. The representative alone is liable for all damages resulting from improper use.*

Duplication in any manner and form - including excerpts - as well as use and/or communication of the content are not permitted without written permission from WOODWAY.

2.4 Replacement Parts

WOODWAY recommends the use of original replacement parts. Original replacement parts have qualities and ensure reliable and safe operation:

- Developed for specific use with the device
- Manufactured for high quality and excellence
- Ensure the legal warranty period (excluding wear parts) or other reached agreements

***Note:** Claims to the manufacturer of any kind due to damage from improper use of any kind are excluded. The representative alone is liable for all damages resulting from improper use.*

2.4.1 Disposal

Wear parts are considered hazardous waste.

After being replaced, wear parts must be disposed of per country-specific waste laws.

2.5 Customer Service

For service questions contact the following:

WOODWAY USA, Inc.
W229 N591 Foster Ct.
Waukesha, WI 53186
USA

Tel: 1 (262) 548-6235

Fax: 1 (262) 522-6235

Email: service@woodway.com

Web: www.woodway.com

For faster processing of your request please have the following data and information available:

- Information on the name plate (specific model/serial number)
- An accurate description of the circumstances
- Customer number (if available)
- What action has already been taken?

2.5.1 Servicing

The address of your local service center can be obtained from the manufacturer. After repair or re-installation, the actions listed under "Setup and Installation" are to be performed as during installation.

3 Technical Data

3.1 Name Plate

Each WOODWAY treadmill receives a serial number during production. Depending on the year of your model, it has an alphanumeric code with 7-8 characters or a numeric code with 9 digits. The serial number can be found on the name plate, which is mounted on the front left of the treadmill frame.

The name plate contains the device's main technical details.

The treadmill range of functions is stated the name plate and on the delivery note.

3.1.1 Keep Handy for Questions

For service questions, the technical information on the name plate must be available.

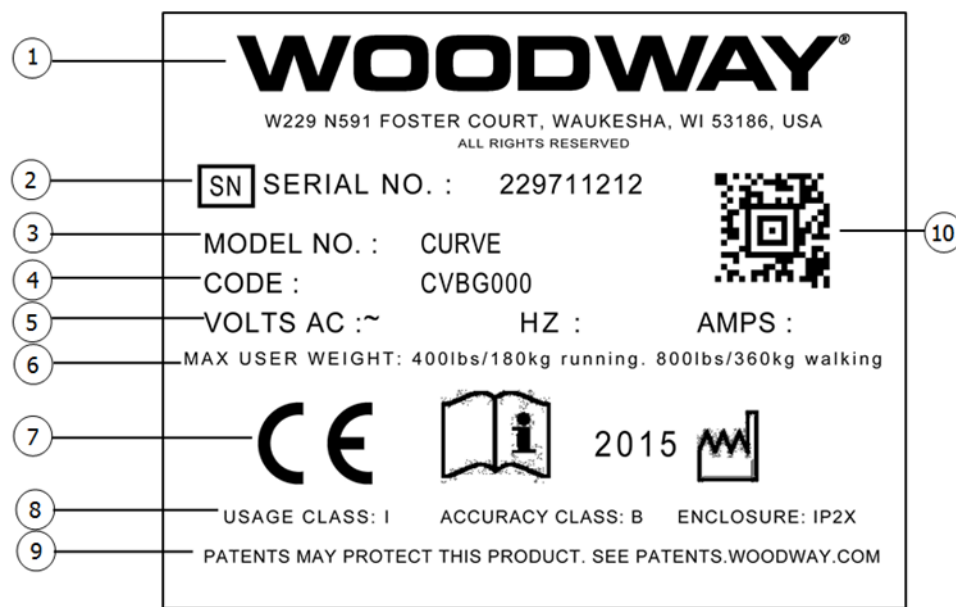

Figure 1- Woodway name plate

1. Manufacturer name, address, and logo
2. Serial no.
3. Model no.
4. Product code
5. Information on electrical connection
6. Max. user weight load
7. Device CE symbol (with number of the named position), note to read and observe operating instructions, and year manufactured
8. Usage class, accuracy class, and enclosure rating
9. Patent protection note
10. 2D universal identification number code

3.2 Technical Specifications

Specification	CURVE, CURVE 1.5, CURVE 3.0	CURVE TRAINER	ECOMILL	CURVE XL	CUVE FTG
Overall Dimensions	33" W x 67" L x 66.55" H 84 x 170 x 169cm	33" W x 67" L x 66.55" H 84 x 170 x 169cm	33" W x 68" L x 66.55" H 84 x 170 x 169cm	38" W x 91" L x 75" H 96 x 230 x 191cm	33" W x 74" L x 72" H 84 x 189 x 184cm
Running Surface	17" W x 56" L (43 x 142 cm) 60 slats	17" W x 56" L (43 x 142 cm) 60 slats	17" W x 56" L (43 x 142 cm) 60 slats	22" W x 86" L (55 x 218 cm) 77 slats	17" W x 67" L (43 x 171 cm) 60 slats
Unit Weight	355 lbs. (161 kg)	350 lbs. (159 kg)	445 lbs. (202 kg)	550 lbs. (250 kg)	415 lbs. (190 kg)
Shipping Weight	440 lbs. (200 kg)	440 lbs. (200 kg)	533 lbs. (242 kg)	625 lbs. (284 kg)	505 lbs. (230 kg)
Drive System	112 bearings 12 roller guides	112 bearings 12 roller guides	112 bearings 12 roller guides	158 bearings 18 roller guides	112 bearings 12 roller guides
Heart Rate Measurement	1-channel ECG accurate, compatible chest strap	1-channel ECG accurate, compatible chest strap	Touch grip pick-up, POLAR compatible receiver	1-channel ECG accurate, compatible chest strap	1-channel ECG accurate, compatible chest strap
Speed (Manually Driven)	0 - No Max.	0 - No Max.	0 - 15 MPH (0 - 24 km/h)	0 - No Max.	0 - No Max.
Slat Type	Replaceable Thermoplastic on composite T-sections			Replaceable Rubber on aluminum T-sections	Replaceable Thermoplastic on composite T-sections
Lateral Movement	+/- 4 mm				
Running Surface Hardness	Approx. 40 Shore A				
Max. User Weight Running / Walking	400 lbs. (180 kg) / 800 lbs. (360 kg)				
Running Surface Above Floor	11" (28 cm)				
Ambient Conditions (Operation)	Temperature: 50°F to 104°F (10°C to 40°C) Relative humidity: 20 - 95% (not condensed) Air pressure: 700 - 1060hPa				

Specification	CURVE, CURVE 1.5, CURVE 3.0	CURVE TRAINER	ECOMILL	CURVE XL	CUVE FTG
Enclosure Rating	IP2X				
Drive Motor	N/A (manually driven)				

3.3 Power Requirements

3.3.1 Curve / Curve Trainer/ Curve XL

The standard versions of the CURVE/ CURVE TRAINER/ CURVE XL are non-motorized and therefore do not require electricity from a wall outlet. Note that the computer on the Curve 3.0 units will require a power source to operate.

3.3.2 Curve/Trainer Prosmart and FTG

The Curve Prosmart Series as well as the FTG Standard and Prosmart will require electricity from a wall outlet. This is in order to properly power the display and brake unit.

3.3.2.1 Electrical Connection

IMPORTANT- The power cord must be properly protected at all times, both when in use and storage.

Below are the standard electrical requirements by region. There are different options depending on which model you own. If you have a different electrical configuration, please contact your sales representative.

DO NOT BEND OR REMOVE PRONGS. The plugs are polarized, meaning the prongs are different sizes and the plug can only fit in the outlet one way; if the plug does not fit, reverse the plug. If other power cord plugs are required, please contact WOODWAY.

Before connecting the treadmill to the power supply, the information on main voltage and frequency (found on the name plate) is to be compared with the on-site connection values. Only connect the device if the values match. Power surges or voltage drops can cause malfunctions or defects in the device.

No other treadmills or devices may be operated on the same supply line. Each treadmill must be operated with its own circuit breaker. The treadmill must be grounded.

DANGER

Danger of Death by Electric Shock!

Improper handling of electrical equipment by unqualified persons can cause fatal electrical shock.

- ▶ If necessary, allow only qualified personnel to perform electrical installation.
- ▶ The power cord must not come into contact with hot surfaces or sharp edges.
- ▶ Electrical parts (eg. motor, power cord, and power switch) must not come in contact with water.

WARNING

Danger of Injury by Falling when Switching the Device Off!

A complete shutdown of the unit caused by power surges or voltage dips can cause abrupt deceleration of the running surface belt.



- ▶ In order to avoid malfunctions, all data on the name plate must correspond with the actual terminal values.

! WARNING

Danger of Injury by Tripping Over Wires!

1. Improperly installed wires present a tripping hazard and danger of injury. Safely lay power cords, interface cable, etc. outside of walking areas.

3.3.2.2 North America

Description	Parameters	
	115 VAC	208/230 VAC
Voltage	Requires at least 115 V from wall outlet. If voltage falls 10% below 115 V, treadmill will shut off and reset.	Requires at least 208/230 V from wall outlet. If voltage falls 10% below 208/230 V, treadmill will shut off and reset.
Frequency	50/60 Hz	50/60 Hz
Current	15 Amp	15 Amp
Wall Outlet Requirements	 NEMA 5-15 R	 NEMA 6-15 R
Outlet Compatibility	Standard 3-prong, hospital grade plug (NEMA 5-15 P) Will fit a NEMA 5-15 R outlet	3-prong plug (NEMA 6-15 P) Will fit a NEMA 6-15 R outlet
Hospital-Grade Low Leakage	For grounding reliability, only connect to proper receptacle marked "Hospital Grade" when using for medical use.	

3.3.2.3 Germany

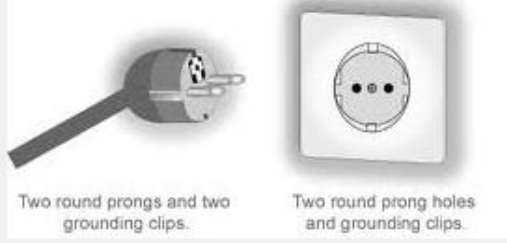
Description	Parameters
	230 VAC
Voltage	Requires at least 230 V from wall outlet. If voltage falls 10% below 230 V, treadmill will shut off and reset.
Frequency	50 Hz
Current	16 Amp
Wall Outlet Requirements	<p>Type F Germany, Austria, the Netherlands, Sweden, Norway, Finland, Portugal, Spain and Eastern Europe</p>  <p>Two round prongs and two grounding clips. Two round prong holes and grounding clips.</p>
Outlet Compatibility	F / "Schuko" plug

3.3.2.4 United Kingdom

Description	Parameters
	230 VAC
Voltage	Requires at least 230 V from wall outlet. If voltage falls 10% below 230 V, treadmill will shut off and reset.
Frequency	50 Hz
Current	13 Amp
Wall Outlet Requirements	
Outlet Compatibility	G/BS 1363 plug

3.3.3 EcoMill

The ECOMILL is non-motorized and therefore does not require electricity from a wall outlet. The display is powered up by the user moving the belt.

The display utilizes a battery back-up to ensure uninterrupted use and will switch off automatically when no training activity has been detected for two minutes.

The ECOMILL has a power switch located on the lower middle of the running base. This power switch enables the battery back-up system and must be in the **ON** position.

3.4 Dimensions

3.4.1 Curve

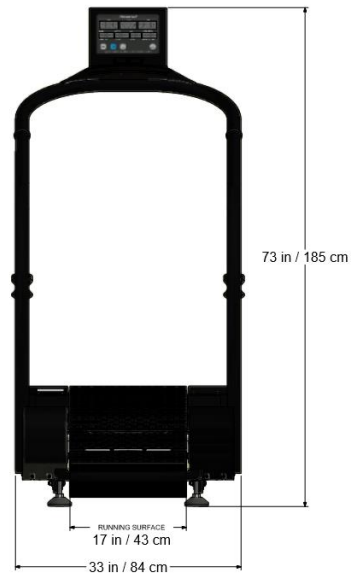

3.4.2 Curve Trainer

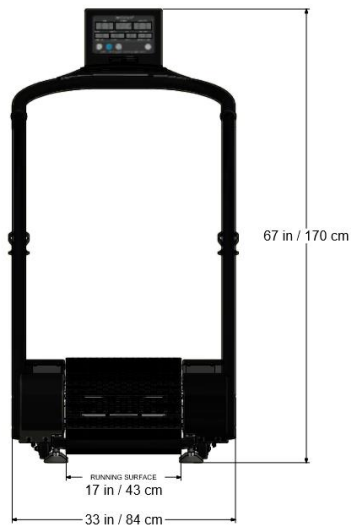
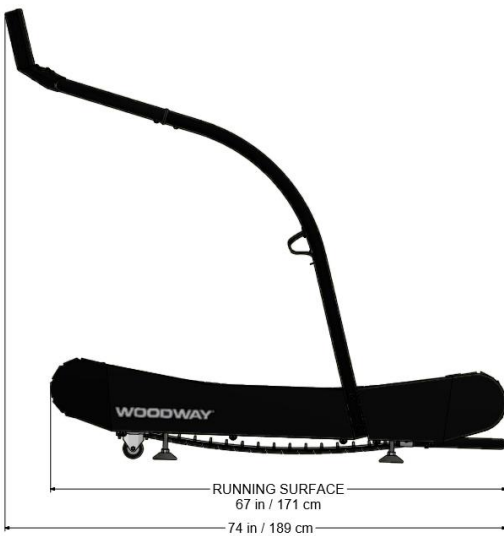

3.4.3 Curve XL

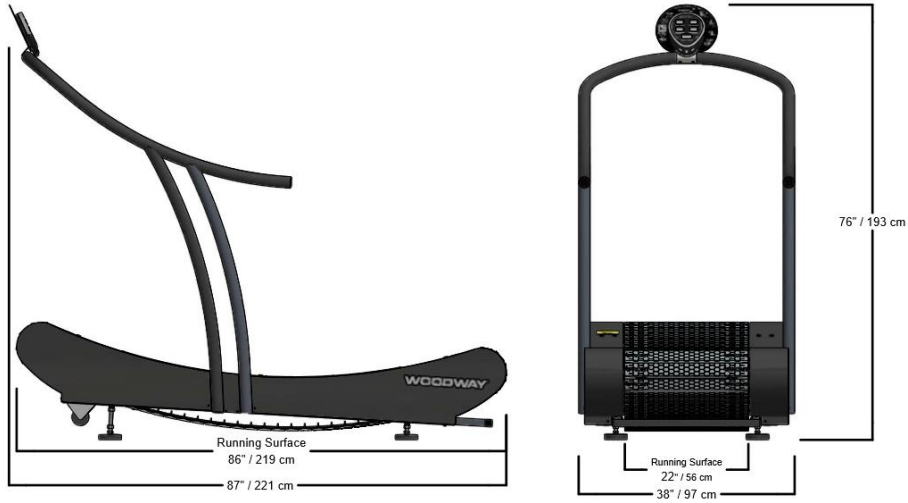

3.4.4 EcoMill

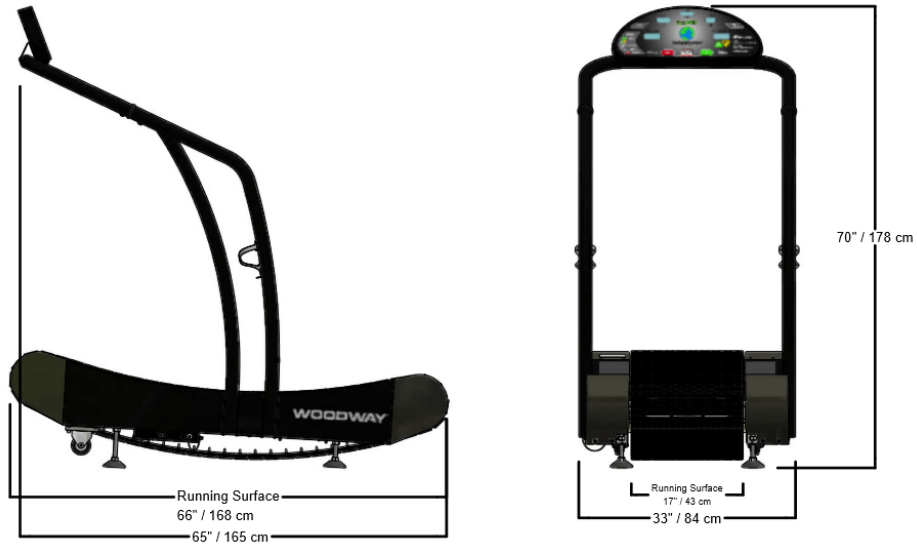

3.4.5 Curve FTG



4 Transportation and Storage

4.1 Safety Notices for Transportation

Check the treadmill for damage upon arrival. Also, check and compare supplied accessories with the corresponding delivery note.

The manufacturer is not liable for damages and missing parts if this information was not recorded in writing on the delivery note upon delivery of the unit. Damage or defects must be reported to the carrier and to the responsible WOODWAY dealer immediately.



WARNING

Risk of Injury by Machine Falling or Falling Over

Improper transportation of the device may lead to it falling over and causing injury or equipment damage.

- Only transport in compliance with the safety regulations.
- Only use the supplied carrying tubes for transport.
- Never lift the device using the railing or protective coverings.
- Ensure stable center of gravity and steadiness during transportation.

4.1.1 WOODWAY Service

If necessary, transport or relocation can be organized and carried out by authorized WOODWAY service partners. For further information please contact WOODWAY Customer Service.

4.2 Transporting the Treadmill

4.2.1 Carrying Tubes

The carrying tubes are to be inserted into the openings provided at the bottom front of the treadmill frame. Do not pull on or remove coverings. If the treadmill must be disassembled, the coverings and the railing unit can be removed to facilitate transport.

4.2.2 Transport Rollers

The treadmill is equipped with two rollers on the bottom front of the device for short transport distances. A handle is fastened to the frame at the back of the device. Using this handle the entire unit can be lifted and maneuvered like a wheelbarrow.

The transport rollers are only functional after the device has been lifted and tilted to a certain height.

Note: *The railing in the front of the treadmill lowers when the back of the device is raised. Pull the device away from the wall before lifting so that the display does not hit anything.*

CAUTION

Risk of Injury From Lifting Heavy Device

The treadmill is heavy. It is recommended to use two people when lifting and maneuvering the treadmill.

4.3 Storage

The device may only be stored in closed, dry rooms. It is necessary to prevent contact with moisture (rain, fog, etc.).

The following environmental conditions are prescribed for transportation and storage:

- Temperature: 0°F to 120°F (-18°C to +49°C)
- Relative humidity: 20 - 95% (not condensed)
- Air pressure: 700 – 1060 hPa

See the **WOODWAY Non-Motorized Treadmill Service Manual** for additional information.

5 Product Description

5.1 Function

The treadmills are non-motorized training devices. The user controls the desired workout speed with the running speed on the upwardly curved running surface.



Figure 2- Non-motorized running motion demonstrated on the Curve models.

1. Basic principle of the rotary drive through moving mass
2. Operation of the drive with a running person

The treadmill is accelerated, slowed, or stopped through the shifting of weight and the resulting running speed. The treadmills function without a motor, so there is no emergency stop device. The treadmill stops on its own. It can take some time before the device stops depending on the running speed.

To stop the running surface, or in the event of an emergency dismount, the runner straddles the running surface on the right and left side panels and lets it coast to a standstill (or user shifts his center of gravity and weight to the rear until the treadmill comes to a standstill).



WARNING

Risk of Injury Through Falling

During training, especially during the initial use of the device there is a danger of injury from falling.

- Familiarize yourself with the treadmill operation before the first training.
- Shifting of weight to the front curved area causes the speed to increase.
- Shifting the weight to the back causes the speed to decrease.
- Hold on to the safety railing during the first training program until you can move safely on the treadmill.

5.2 Running Surface

The walking surface belt consists of individual slats which are mounted on a set of wedged-tooth belts.

5.2.1 Slat Design

The individual slats consist of two components, a soft rubber-like surface, and a T-shaped composite base. Due to the approximately 3/8" thick rubber-like surface and the structural composite T-slat, in combination with the curved running surface, WOODWAY Curve treadmills have the "world's most ideal running surface for treadmills". Due to the soft running surface, most of the impact energy is absorbed and local pain in extremities which is associated with long runs is reduced. The interaction between the belt system and the transport system prevents friction and heat generation. This increases the service life of the running belt and the entire treadmill.

The WOODWAY running surface differs fundamentally from running belts on conventional treadmills (for which cotton-nylon belts are normally used). On your WOODWAY treadmill you may initially notice higher surface grip than you have experienced before. The more you use your treadmill, the more you will grow accustomed to the grip. As with all treadmills, it is also important on a WOODWAY treadmill not to shuffle your feet if possible.

5.3 Transport System

5.3.1 Bearing Rails

The bearing rail system consists of two support rail units, with steel-wire-reinforced V-belts, high-performance ball bearings, and guide rollers. The bearing rails support the running surface and are essential for the reduction of wear and friction of the belts.

5.3.2 Side Belts

The side belts fill several important functions; they hold the individual slats together, support the running surface, and prevent the running surface from slipping to the left or right. The smooth v-shaped portion of the side belts runs along the bearings and roller guides.

5.3.3 Load Distribution

The bearing rail supports all bearings and guide rollers and distributes the load evenly on the running surface. Form-fitted guide rollers on the front and back prevent tracking errors and support the running surface belt; they are coupled by a toothed belt and thereby synchronized, thus making the curve possible. The individual bearings on either side also distribute the load over the entire running surface.

The transport system design provides for low wear and almost no friction.

- Approx. 150,000 miles (240,000 km) functional service life
- High belt service life (one running surface belt for one treadmill life)

6 Setup and Installation

6.1 General

Setup and installation is the initial intended use of the device. Ensure that the conditions applicable to basic safety and health requirements are met. Read these operating instructions completely before installation.

Before installing the device, operational and functional safety are to be tested. This includes correct installation and operator instruction.

6.2 Installation

Only install your treadmill at ground level on a sufficiently firm, stable surface. The surface should be as flat as possible to ensure that the frame only bends minimally. Do not place the treadmill directly on thick or high-pile carpet due to moving parts on the bottom.

 **NOTE**

Maintain the Safety Area
Keep the area behind the treadmill clear.
Ensure that there is a clearance of at least 78 in. (2 m) between the back of the treadmill and walls or furniture. Sloping ceilings may not extend into this safety area.

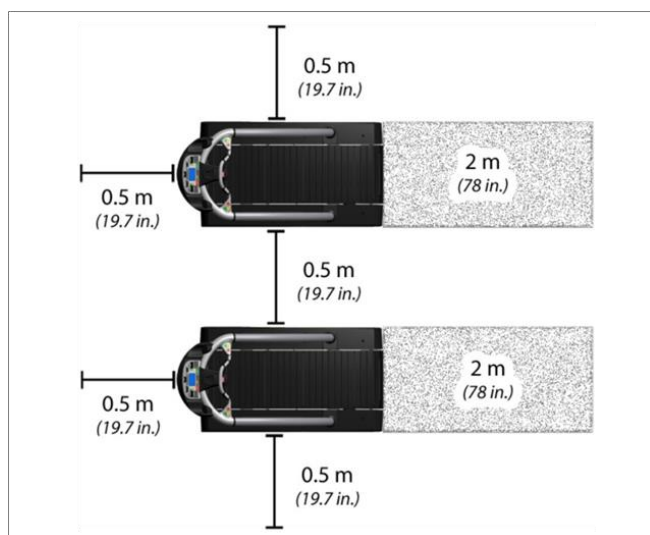

Figure 3- Maintaining a safe, clear area on all sides of your treadmill

If the installation site has high-pile carpeting, a floor protection mat should be placed under the treadmill. Using a floor protection mat reduces the production of lint entering the treadmill. This also minimizes carpet wear under treadmill base.

WOODWAY also has appropriate mats available.

For more information call WOODWAY Customer Service.

6.3 Assembly Instructions

The non-motorized treadmill is usually delivered and installed in the place of use by WOODWAY or an authorized carrier.

The handrail assembly and the side panels can be removed to reduce the weight and facilitate transport into other rooms.

Note: The required assembly tools and materials are included in the scope of delivery. Standard screws are used; these are not compatible with metric fastening elements.

6.3.1 Positioning the Device

1. Position the unit on a sufficiently solid horizontal surface.
2. There are wheels under the front end of the treadmill. The treadmill can be moved on the wheels by lifting it using the handle on the back of the device. The transport wheels are only functional after the device has been lifted and tilted to a certain height.
3. To carry the device, use the carrying tubes in the lower part of the front of the treadmill. The square steel tubes fit into two square brackets at the front of the treadmill.
4. Remove the tubes from the brackets after transport.



Figure 4- Curve treadmill base

Note: The device is very heavy! Use two people and ensure that the carrying tubes cannot slip out of the brackets during transport.

6.3.2 Mount the CURVE Display Screen to the Handrail

The following instructions are applicable for the **Curve**, **Curve 1.5**, and **Curve 3.0** and **Curve XL**.

1. Run the wires down the right side of the horseshoe from the runner's perspective.



2. Open the display box.
3. Connect the two (2) plugs.

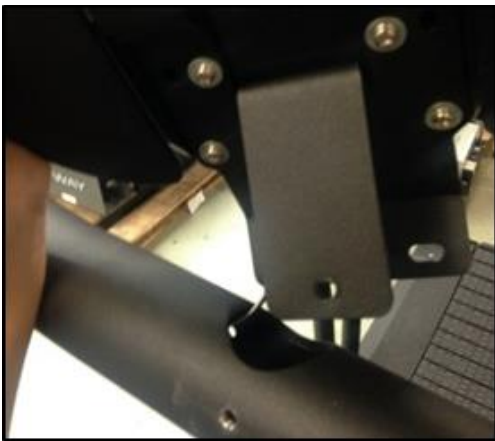

Note: One from the railing, and one from the display.

4. Connect plugs until it clicks in place.
5. Stow the excess wire in the railing tube.

6. Align the display on the railing bracket, so that the top and bottom holes are aligned with the screw holes in the railing.



7. Fix the bracket at the top and bottom with provided Allen screws.
8. Finally, open the battery compartment on the back of the display and
9. Insert two standard AA batteries (not included).

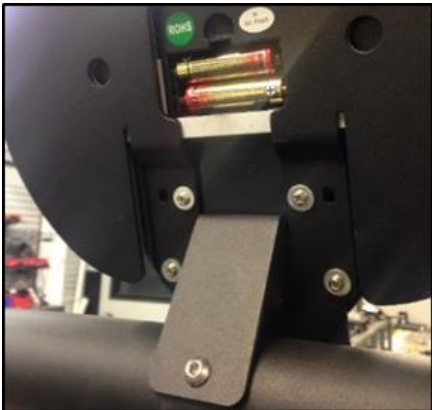

10. Close the battery compartment.

6.3.3 Mounting the Handrails

Curve, Curve 1.5, Curve 3.0, ECOMILL (ALIEN HEAD DISPLAY ONLY?)

1. One side at a time, set railing into the slot on the side of the frame facing forward.

***Note:** The lettering on the running belt should be readable when standing at the foot of the treadmill.*

2. Hold the railing in place while it is fixed to the frame using supplied hex screws and the 9/16" socket wrench.

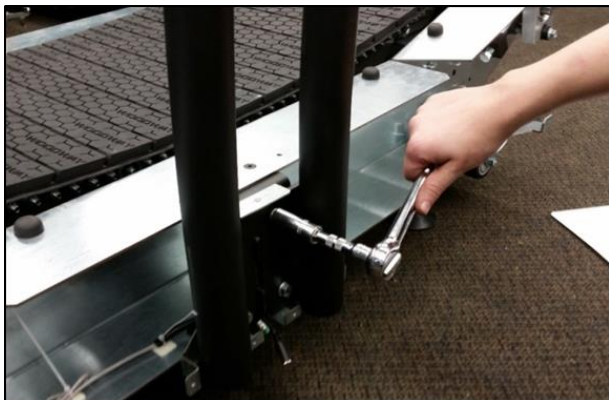

***Note:** Do not tighten bolts, bolts will be tightened as final step of handrail installation.*

3. Place the aluminum coupler with the slotted plastic retainer sleeve into each end.

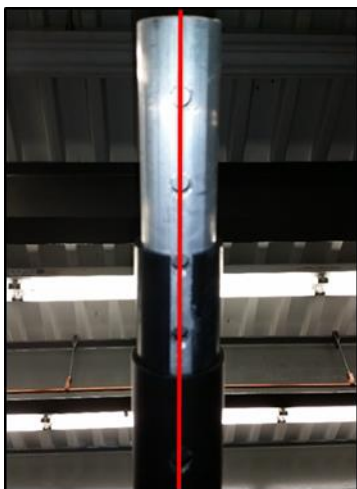

***Note:** Make sure the slot and holes are lined up as shown to allow for installation of the hardware.*

4. With a mallet, pound the coupler and slotted sleeve into the handrail until the hole in the handrail lines up with the hole in the coupler.



5. Fasten couplers to handrails on each side with a 3/8" Allen wrench and the provided bolts and lock washers.



6. Slide the second plastic sleeve onto the other end of each coupler.

7. With the horseshoe piece with the display attached, thread the data wire(s) through the couplers and down through the handrail tubes.



8. Place horseshoe piece over the coupler assembly so it is snug.



9. The data wires should be accessible through the bottom of the handrails near the frame.
10. Connect the male and female ends.



11. Store any spare slack back into the handrail to protect wires from inadvertent future damage.
12. Ensure the slots lined up with the holes of the coupler.

13. With a soft rubber mallet, pound the horseshoe into the place so that the horseshoe is flush against the isolator.

Note: *The holes on the horseshoes should line up with the holes of the couplers.*



14. Fasten the horseshoe to the coupler with a 3/8" Allen wrench and the supplied bolts and lock washers.



15. With the entire assembly now fastened, return to the bolts attaching the assembly to the treadmill frame and tighten them snug with a 9/16" socket wrench.

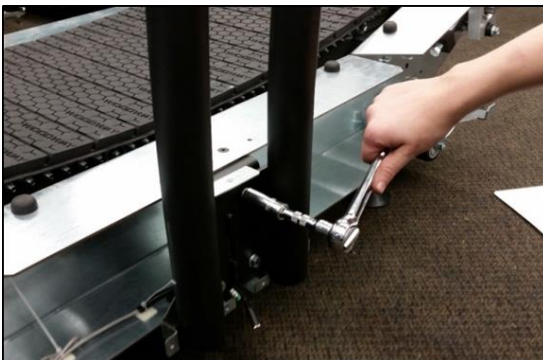



WARNING

Danger of Falling Off Treadmill

There is a danger of falling when stepping onto the treadmill while holding the railing.

- Do not step onto the running surface while holding weight.
- To position the railing, have each person stand on the ground on either side of the device.
- Do not use the CURVE treadmill without the safety railing! There is a danger of injury!

Curve XL

Note: It is recommended to have a second person assist in inserting the railing tubes or with the assembly.

1. Hold the railing one person on each side and have each person carefully walk the handrail until it is in position.



WARNING

Danger of Falling Off Treadmill

There is a danger of falling when stepping onto the treadmill while holding the railing.

- Do not step onto the running surface while holding weight.
- To position the railing, have each person stand on the ground on either side of the device.
- Do not use the CURVE treadmill without the safety railing! There is a danger of injury!

2. Before inserting the railing into the seat, check that the data wire is protruding out of the cutout at the base of the device and that the connecting wire is protruding from the opening at the bottom of the railing.
3. Ensure that neither wire will be damaged (crimped, cut, or twisted) by the bottom edge of the railing.
4. When you have checked the position of the wires, insert the railing into the seat until it stops.
5. If the railing does not slide in easily, adjust the insertion angle by slightly moving the railing to the left and right or front and back.



6. Connect the ends of the display and data cable and stow any excess cable in the opening in the railing.

7. Fix the railing to the frame between the two tubes on the right and left (4 points on each side) using the supplied hex screws and socket wrench.
8. Screw all 4 bolts in loosely before tightening them fully with the socket wrench.



6.3.4 Mounting the Side Panels

6.3.4.1 Curve, Curve 1.5, Curve 3.0, ECOMILL



NOTE

The CURVE XL side panels are different from the standard non-motorized treadmill side panels.

If mounting CURVE XL side panels, see Section 6.3.4.2 on page 47.

Perform the following steps when installing **Curve**, **Curve 1.5**, **Curve 3.0**, or **EcoMill** side panels.

1. Place the four side covers on the frame with the front covers overlapping the two back covers.
2. Place the four side covers on the frame with the front covers overlapping the two back covers.
3. Loosely fasten side covers where they overlap in the middle of the frame with the small Allen wrench screws
4. With the Philips head screws, loosely fasten the side covers on the sides of the frame.



5. Loosely screw in the Philips head screws included to the back of the frame on each side.

- Using the end cap slots, slide the end cap down onto the screws and into place.



- Once all side covers are loosely in place. Tighten all screws fastening them.
- Loosely screw in two Philips head screws in between the two poles of the right and left handrail.



9. Place the side panels on the frame. The curved design and the cutouts for the railing indicate the proper position. The slots in the bottom of the side panels will allow it to sit on the two screws one put in on the previous step.



10. Using the last two screws provided, fasten the side panel fully on the top
11. Tighten all screws.
12. The screws should tighten easily and without much resistance.
***Note:** If this is not the case, press slightly on the panel from the outside until the holes in the frame and side panels are aligned and the screw can engage the thread.*

6.3.4.2 Curve XL

The CURVE XI panels consist of two separate panels on each side, for a total of four panels.

1. Place the back-side panels on the device before the front panels. The curved design and the cutouts for the railing indicate the proper position.
2. Place the front panels overlapping the back panels.
3. Ensure that they are in the correct position on the frame and not resting on the timing belt or guide rollers.
4. Check that the 6 holes on the top of each side panel are directly above the underlying holes in the frame.



5. Loosely install the six screws into the top of the covers.



6. Press the cover as needed from the outside to line up the bottom holes in the side cover with the holes in the frame. Loosely install two screws each end.



7. Once all top screws and four bottom screws (per side) are all engaged, tighten all screws to be snug using a Philips screwdriver.
8. Fix right and left cover plates with Philips screws (two on side, one of top)

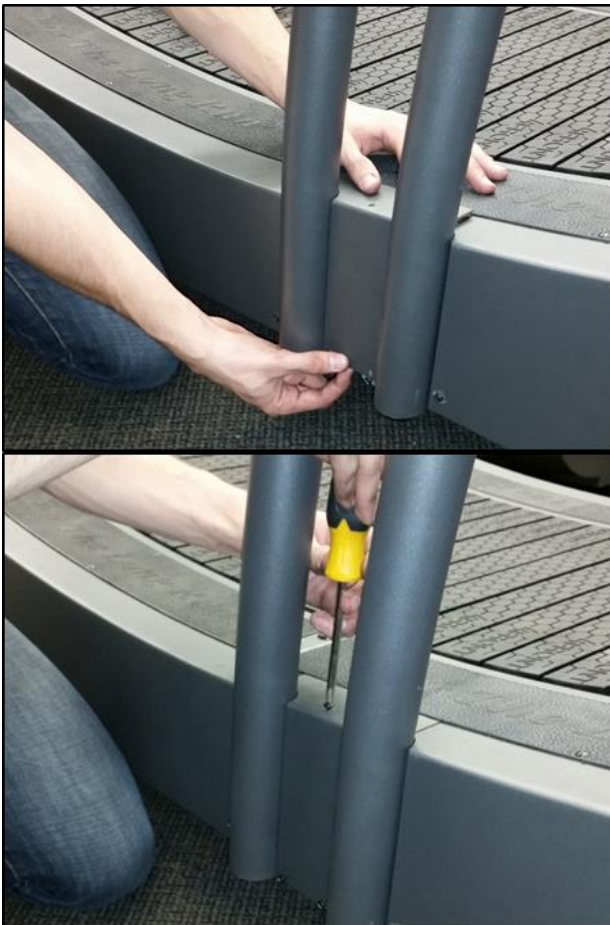

6.3.5 CURVE/TRAINER STANDARD DISPLAY

The curve models consist of the base, two uprights, and the display.

1. Remove the back right-side cover by unscrewing 4 Philips screws on top and 2 underneath.

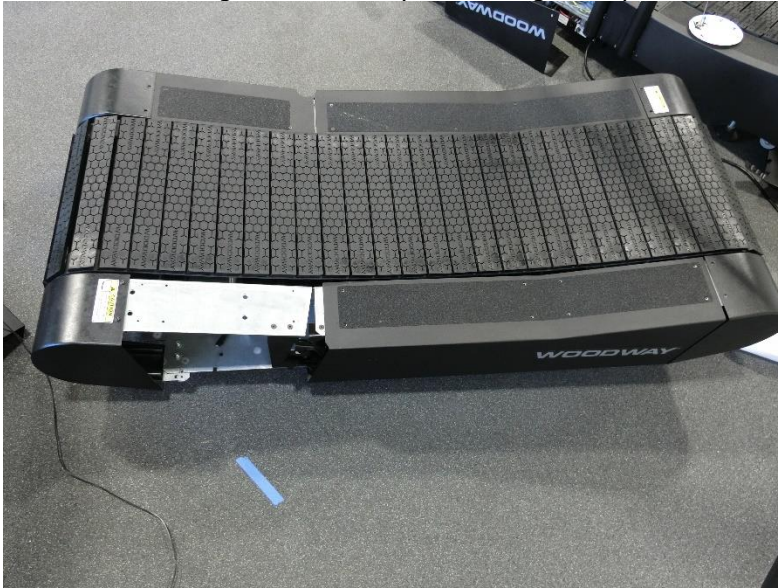

2. Insert the brass bracket into the trainer handrail.



3. Make sure the brass bushings are sticking out of the holes.



4. Insert the socket head bolts and lock washer through the fixture so roughly 3/8" is protruding through the inserts.

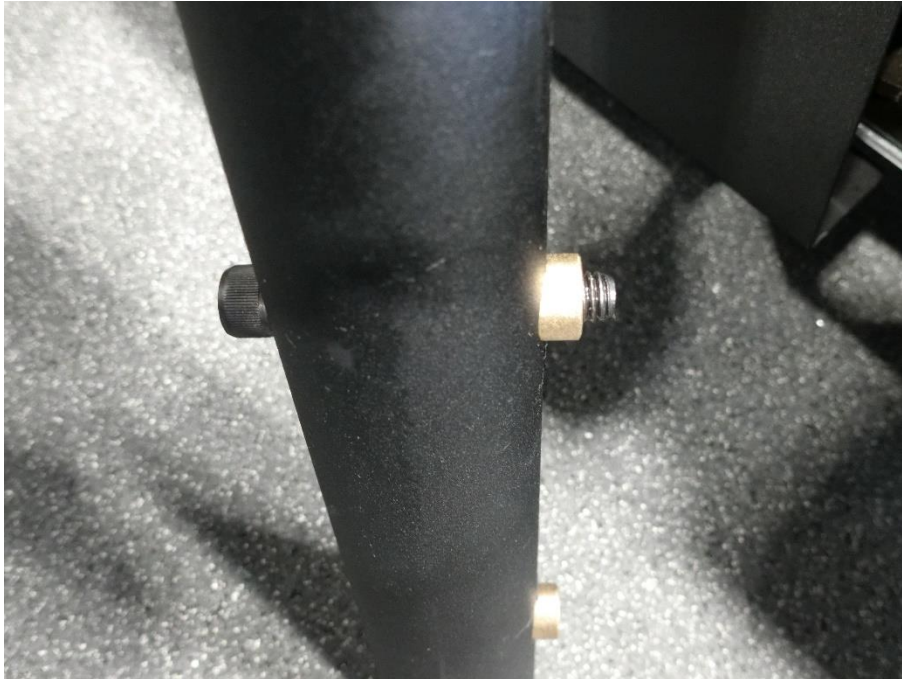

5. Using a 5/16" T handle, attach the handrail to the frame on both sides. Fasten bolts all the way/snug.



6. Take the display and handrail and feed the wire down the righthand side.



7. Add the Crush sleeves and put the front horseshoe on the crush sleeves.



8. Make sure the wire come out the bottom of the handrail.



9. With the gap in the crush sleeves pointing down, fully slide the horse shoe on the uprights.



10. Secure the horseshoe using 4 3/8-16 screws and 4 3/8" lock tooth washers with a 7/32" Allen wrench.



11. Find the cable on the bottom of handrail and connect display cable to the matching cable in the treadmill frame

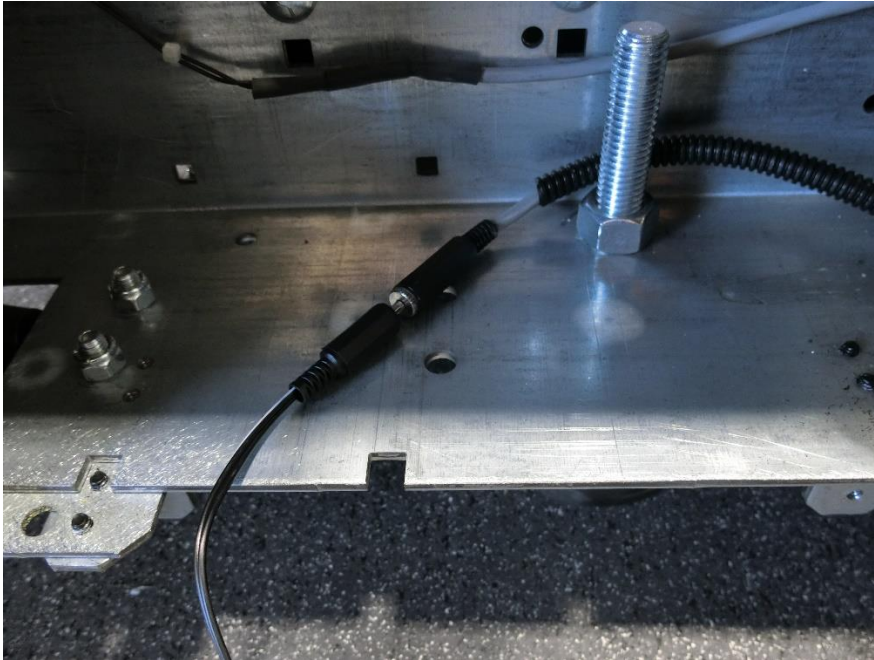

12. Reattach the back-right side cover with the 4 countersunk Philips on top and 2 round Philips underneath.



6.3.6 CURVE PROSMART ASSEMBLY (Curve, Trainer)

The Curve Prosmart is assembly consists of the base, 2 uprights, and display.

Note: If a trainer, use handrail assembly instructions from Previous version

1. Remove right side cover set.



2. Bolt on left handrail to the curve base.



3. Use the 3/8" bolts and lock washers to secure the handrail to the base



4. Add the Right upright to this the base of the curve.



5. Take display handrail and run the wires down the right side.

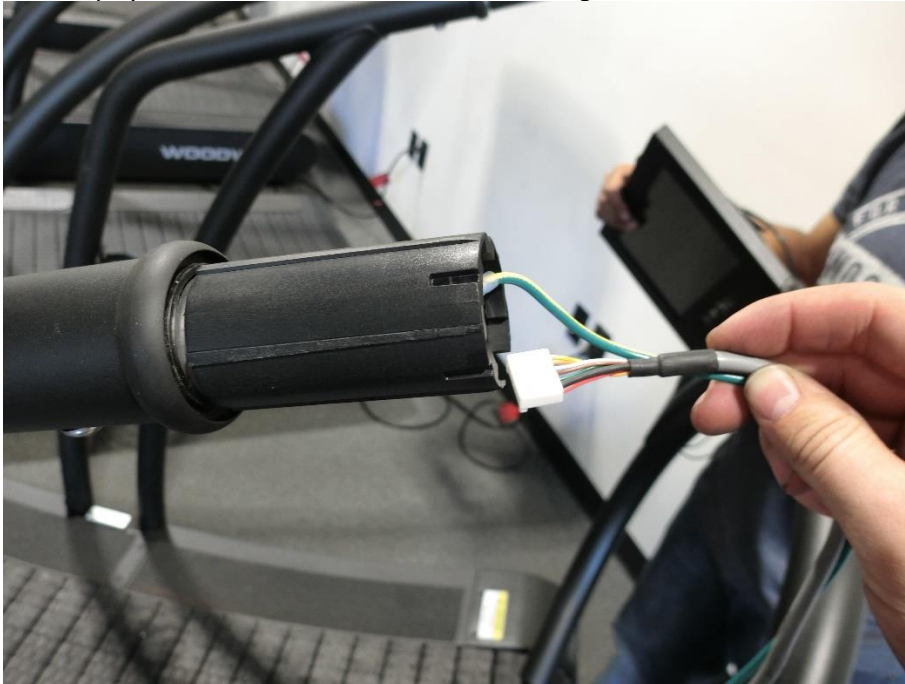

6. Move the horseshoe closer to the uprights while feeding the wires down the handrails.



7. Pull the wires out of the bottom of the tubing.

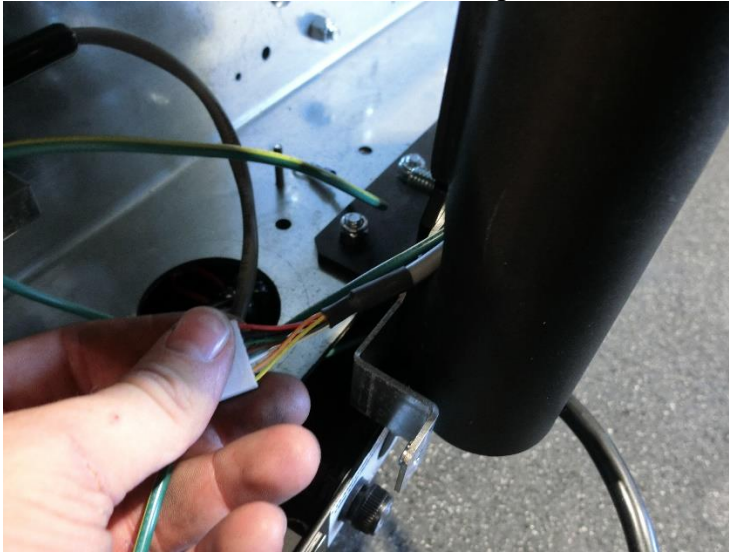

8. Take the horseshoes and add it to the crush sleeves on the uprights.



9. Secure the display handrail with 3/8-16 Screws and 3/8 lock tooth washers with a 7/32nd Allen wrench.



10. Connect the ground wire to the ground wire tab.



11. Connect the display cable to the DAQ Board.

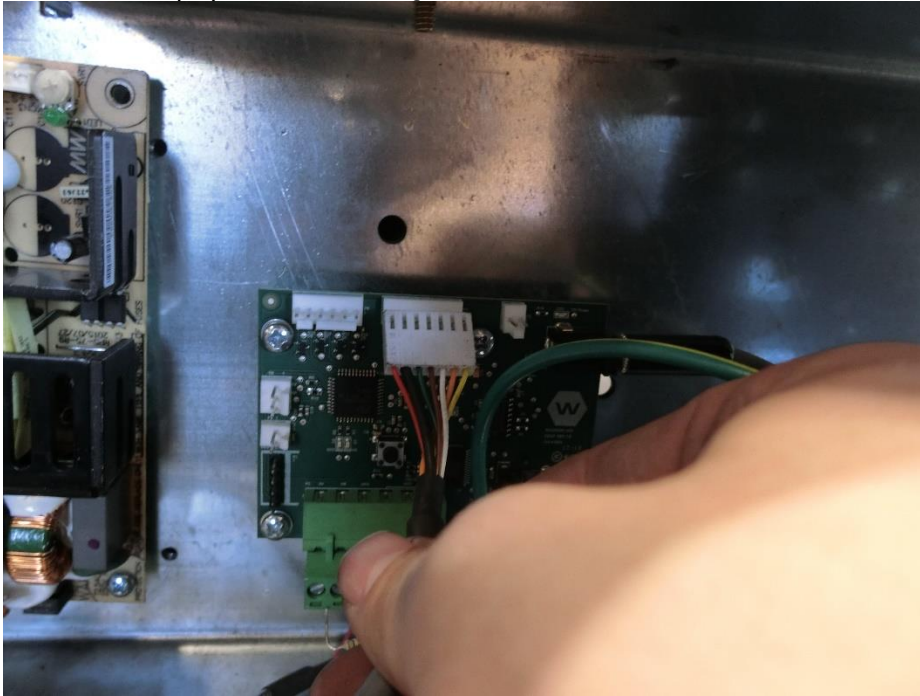

12. Connect the ethernet cable to the Ethernet port that runs to the AC bracket.

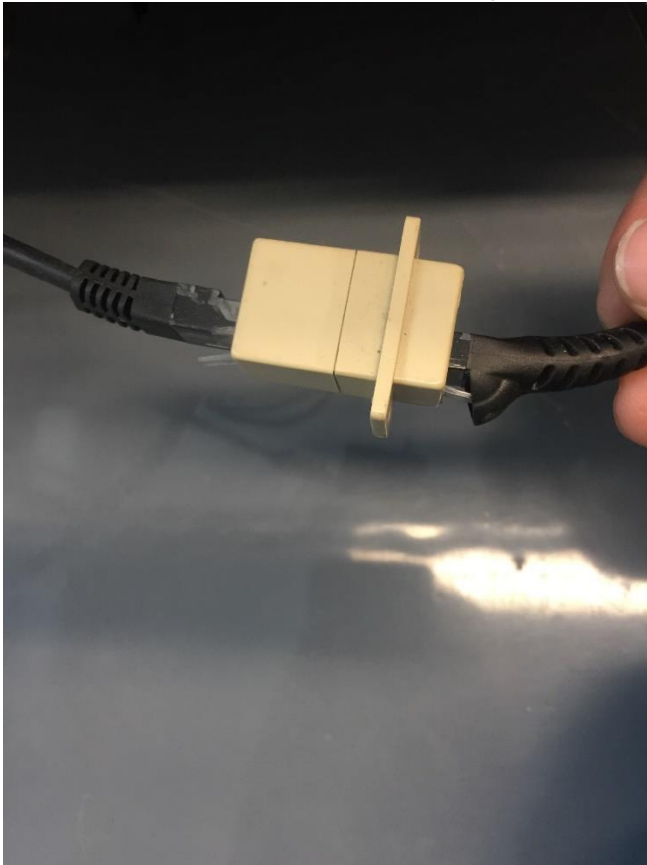

13. Reinstall the right-side covers.



14. Take the side cover plate and install it between the handrails by two Philips screws on the side and one on the top.



FTG ASSEMBLY

The FTG consists of the base, 2 uprights, the display, and push bar.

1. Take off the all side covers using a 5/32 Allen wrench on 8 endcap screws and a Philips screw driver for the side cover panels.



2. Install each of the uprights by placing onto threaded stud PEMs on each side.



3. From underneath the handrail, Add 2 self-locking 3/8-16 nuts to the pegs.

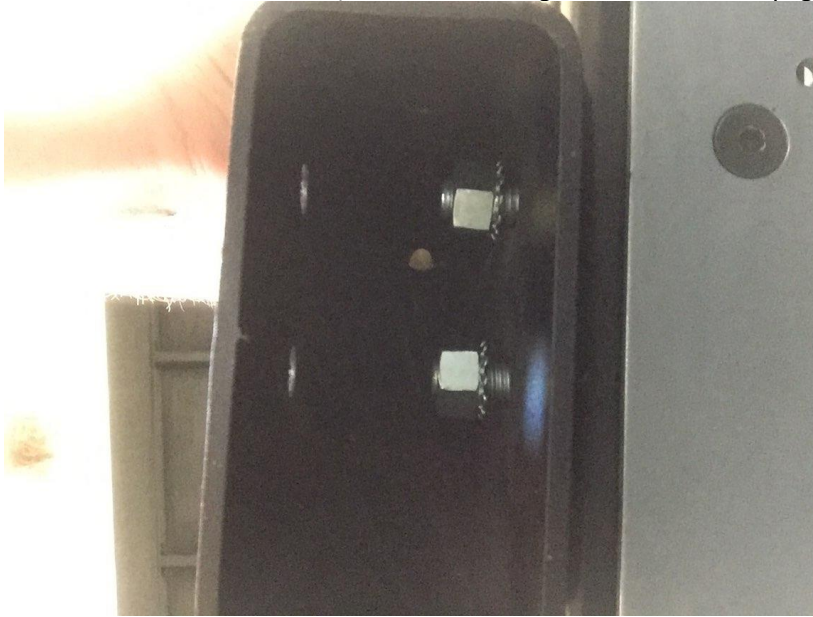

4. Slide the block up into the front of the handrail. Use 2 5/16-18 countersunk screws to secure it to the frame.



5. Hold the display assembly near the front of the handrails and feed the wires down the left handrail.
NOTE: Be sure the side switch ribbon routes through the access hole in the top tube.



6. Use the 3/8-16 screws and 3/8" toothed lock washers to install the display into the uprights with a 7/32nd Allen wrench.



7. Use the same 7/32nd Allen wrench and secure the push bar to the uprights



8. Take the self-drilling screws and screw the push bar to the front horseshoe.



9. Take the wires from the bottom of the handrail and run them up through the hole in the bottom.



10. Take the ground cable and attach it to the ground tab.

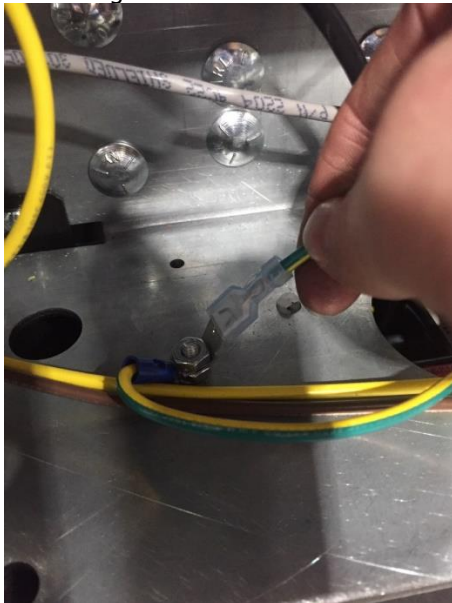

11. Take the Display cable and run it to the DAQ board.

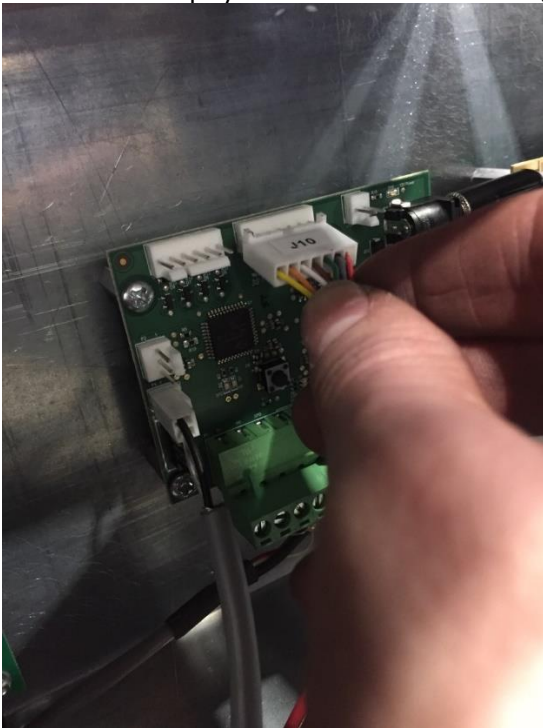

12. Take the Ethernet cable and run it to the ethernet jack in coming out of the AC bracket.

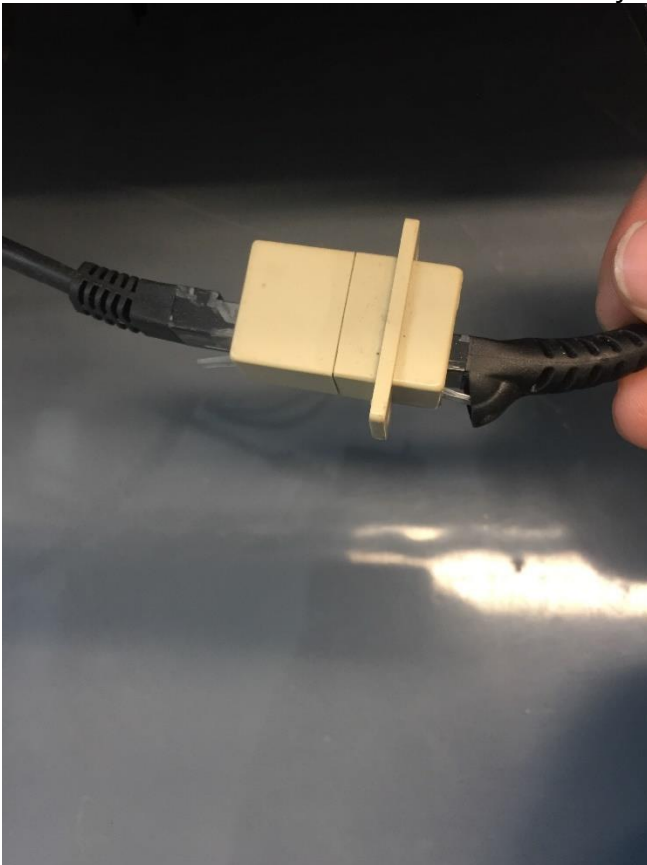

13. Feed the side switch overlay to the housing.



14. Connect Overlay Ribbon the Side switch wire.

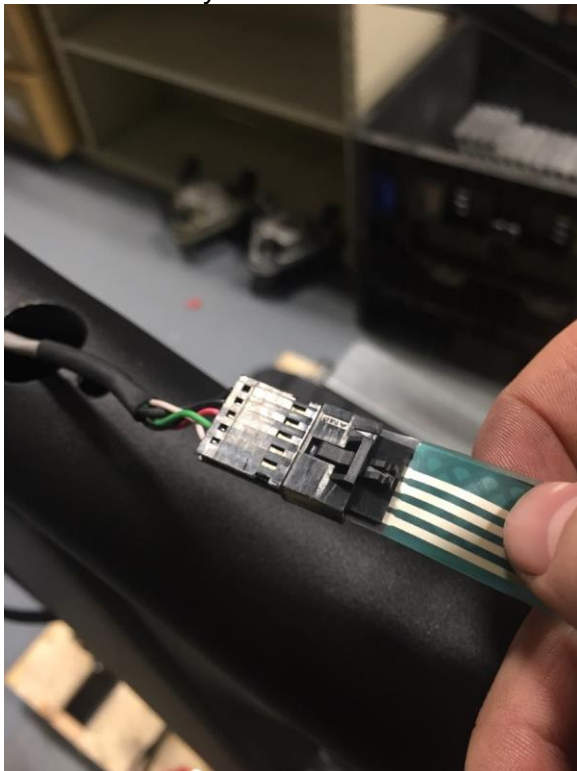

15. Feed the overlay ribbon and wire into the handrail. Using a 10-24 patched countersunk screw, align and install the side switch plastics.



16. Peel off the backing layer of the adhesive on the overlay and press the over to the plastic.



17. Reinstall all side covers using a 5/32 Allen wrench on 8 endcap screws and a Philips screw driver for the side cover panels.

7 Operation

7.1 For Your Safety

For safe operation and successful training please read the following points for your own safety before starting to use the treadmill.

If you are over 40 years old, have a heart condition, are overweight, or are out of shape, a visit to the doctor is recommended before beginning an intensive training program.



NOTE

The user/owner or representative of the equipment is responsible for ensuring that regular maintenance and inspection of the treadmill is carried out. Defective components must be replaced immediately. The treadmill should not be used until it is repaired by a professional.

- The non-motorized treadmills do not have a motor and the belts move freely. Always mount and dismount the treadmill from the rear base of the slats.
Note: Always hold on to the railing during mounting and dismounting.
- Keep loose-hanging clothing and towels away from the running surface. Ensure that shoelaces do not extend beyond the bottom of the shoe sole.
- Keep the area behind the treadmill clear and allow a space of at least 78 in. (2 m) between the end of the treadmill base and walls or furniture.
- Keep hands away from all moving parts.
- Children and animals may not mount the treadmill. Never leave children or animals near the treadmill unattended.
- Check the treadmill for defective or loose components before use and replace or repair if necessary.
- Due to the manual mode of operation, there is no guarantee that the treadmill running surface belt will stop immediately if required (e.g. when an object is caught in the treadmill belt or rollers).
- Mount and dismount the treadmill with caution. Never mount or dismount the treadmill when the running surface is moving.
Note: For safety measures, hold on to the railing and straddle the running surface with your feet on the left and right sides.
- Do not dismount the treadmill until the running surface stops moving completely.
- Wear designated running shoes with a high degree of grip.
- Do not use shoes with heels or leather soles.
- Do not use running shoes with spikes.

- To protect your treadmill surface from wear, ensure that there are no stones in your shoe soles.
- Take a few minutes to get your heart rate in the desired training range.
- Walk slowly for some time after a training session to give your body enough time to cool down. During this time your heart rate will go back to the normal range.
- Never let loose objects (e.g. balls) roll under the treadmill. They could be pulled into the device during operation.

7.2 Safety Equipment



WARNING

Dangerous Situations During Operation Can Cause Injury

Conditions during use of the device that do not correspond to the normal function require an immediate stop. Each actuation of the emergency stop switch causes the running surface to emergency stop, which presents an additional risk of falling!

- Immediate stopping of the device caused by an installed safety device
- Clarification and elimination of causes of the dangerous situations only by WOODWAY Customer Service
- Only restart the device after approval by WOODWAY Customer Service

7.2.1 Controlled Start Speed (ECOMILL)

The ECOMILL is designed to control the maximum belt speed for user safety. The initial start/control speed is 1mph (1.6 km/h) to ensure the user has adequate time to adjust to the non-motorized running surface. Once acclimated, the user can then adjust the maximum speed to the desired workout speed.

7.2.2 Emergency Stop with Pull Cord (ECOMILL)

The emergency stop with pull cord is used to activate the treadmill. If the stop switch magnet is not fixed to the front display panel or not properly positioned, the treadmill cannot be put into operation. This safety feature serves to protect the user, should he lost his balance or in an emergency. The plastic clip is to be fixed to the user when the treadmill is used. When the magnet (trigger) is removed, the drive motor is switched off and the running surface stops. The running surface cannot stop immediately when running at high speeds, since the weight of the running surface needs to be decelerated and there is excess residual energy due to the fast movement. The safety magnet can also be used to immobilize the treadmill and prevent a third party from using the device. To prevent the use of the treadmill, for example when not supervised, the safety magnet with pull cord can be stored in a safe place and the treadmill cannot be put into operation.



WARNING

Danger of Injury Due to Improperly Installed Pull Cord

If the pull cord clip is not fixed properly before a workout, the emergency stop magnetic switch will not be triggered and there is a risk of injury in the event of a dangerous situation.

- The use of the pull cord is mandatory!
- Securely attach clip to tight clothing (e.g. the waistband) before starting the workout.

7.2.3 Single Direction Motion

The non-motorized treadmills are designed so that the user drives the running surface and controls the speed. This is only possible due to the innovative curved design combined with gravity.

7.2.4 Only Forward Movement

For the safety of the user, the running surface only rotates in one direction, which only allows use of the device for running forward (not for running in reverse). This provides for a virtually locked running surface for mounting and dismounting the treadmill from the rear.

The non-motorized treadmills may only be mounted in the rear from the side. Never mount from the front. When the treadmill is mounted from the front, the running surface immediately starts to move and there is a high risk of accident.



Figure 5- Mounting the Curve from rear of the treadmill base

7.2.5 Safety Railing

The non-motorized treadmills are equipped with a railing that extends along both sides and is bowed around the front. This allows the user to maintain direct contact, to obtain safety and stability along the entire curvature of the running surface.

For safety reasons the user should hold on to the railing when necessary (e.g. for stopping).

⚠ CAUTION

Risk of Injury From Lifting Heavy Device

The treadmill is heavy. It is recommended to use two people when lifting and maneuvering the treadmill.

7.3 Practical Training

7.3.1 Professional Consultants

For all treadmill training beginners, it is recommended to seek the advice of a professional fitness instructor or personal trainer, to obtain an overall fitness assessment before starting an exercise program, and to develop an optimal training program.

For optimal use and safety during treadmill training, WOODWAY recommends running on the treadmill in an upright and natural running position and to avoid dragging foot movement.

Before the first training observe the treadmill function notices.

7.3.2 Warm-Up and Cool Down

A warm-up before each workout and a cool-down after each workout is recommended. If possible, you should always do some basic stretching exercises for the legs before and after training. The stretching exercises make you more flexible which prevents muscle soreness and injury during routine activities.

7.3.3 Proper Body Form

When running or walking, it is important to maintain proper form to maximize efficiency and results and minimize the possibility of personal injury.

Keep your posture upright; avoid leaning forwards or backwards from the waist, as this can cause unnecessary back strain and decrease your efficiency. Keep your head, shoulders, and hips in line with each other and aim to have your foot strike the running surface in line with your center of gravity (i.e. you should strike the running surface with the midfoot or forefoot). If you land on your heels, you are over-striding and should shorten your stride to increase momentum and overall efficiency.

Keep your arms at your sides, either relaxed and naturally pendulum-like (walking) or with a loose 90-degree angle, bending at the elbows (running). Do not allow your hands to cross the center of your body or your shoulders to move from side to side.

7.3.4 Measuring Heart Rate

To select the optimum level for the workout, it is important to determine your heart rate and pulse as accurately as possible. For this, the use of a high-quality heart rate monitor is recommended. If you do not have a heart rate monitor, you can take your pulse by placing your fingers on the underside of your wrist or on one side of your neck. Look at the second hand of a clock and count how many beats you feel in 15 seconds. Multiply this number by four to calculate the BPM (beats per minute). Your heart rate is required when you do your fitness test.



7.3.5 Calculating Maximum Heart Rate

To determine your maximum heart rate, subtract your age from the number 220 (general formula). The difference approximates your maximum heart rate. This formula is used by the American Heart Association (AHA) and the American College of Sports Medicine (ACSM). A stress test performed by your doctor determines maximum heart rate. The American Heart Association recommends undergoing a stress test if you have a history of heart disease or if you are over 40 years old and starting an exercise program.

7.3.6 Heart Rate Recommendation

During training, it is recommended not to exceed a value of 85% of your maximum heart rate. Our programs are designed so that the heart rate remains within the target range. Your target range is between 60 and 75% of your maximum heart rate. If you find that your heart rate is above the 75%, you are probably running too fast. Reduce your speed or stop your workout for a moment to bring your heart rate back to the target range.

7.3.7 Training Frequency

At the beginning of training allow yourself enough time to get into shape. After a break from training, you should also allow sufficient time to rebuild physical condition.

7.3.8 Endurance Training

The priority is regularity and persistence of training - not intensity. Fitness experts recommend in the beginning training three to four times per week within your target heart rate for at least 20 minutes per workout. Your primary objective should be to reach a level of fitness with which you can easily keep your heart rate in the target range for 50-60 minutes, four to five times per week.

7.3.9 Running Shoes

To prevent sore feet and sore muscles caused by incorrect footwear, the use of high quality running or jogging shoes is recommended. Ensure there is adequate heel and arch support.

7.3.10 Heart Rate Chart

Age	Max Heart Rate (BPM)	60% of Max Heart Rate (BPM)	75% of Max Heart Rate (BPM)	85% of Max Heart Rate (BPM)
20	200	120	150	170
25	195	120	150	160
30	190	110	130	150
35	185	110	130	150
40	180	100	130	150
45	175	100	130	140
50	170	100	120	140
55	165	90	120	130
60	160	90	120	130
65	155	90	110	130
70	150	90	110	120
75	145	80	100	120

*BPM: Beats per minute,

Source: American College of Sports Medicine

7.3.11 Contact Heart Rate Measurement (ECOMILL)

Grips located on the side handrails transmit the user's heart rate. The transmission begins when the user holds on to the grips. After starting the device, the user may hold his hands on the grips for a heart rate measurement at any time. Please wait 15 seconds to obtain an accurate heart rate reading. The user's heart rate is automatically displayed on the display panel under *heart rate*.

Note: *The measurement of the heart rate via grips is not as exact as EKG and is only considered an approximation.*

7.4 Heart Rate Monitor

The display was designed so that the user's heart rate is indicated when compatible heart rate transmitters are used, i.e. POLAR® measuring device (GymLink compatible). To display the user's heart rate accurately on the screen, the built-in receiver display must receive a stable heart rate signal from the transmitter.

Please visit www.polar.com/us-en/support/compatibility_with_my_Polar to view a full list of monitors and devices with POLAR® (GymLink) and compatibility.

The heart rate system consists of three main elements:

- Sensor/transmitter
- Chest strap/belt
- Measuring device/console

The receiver for the wireless system is installed in the measuring device assembly or the console display. When in operation the display shows the heart's activity in beats per minute (BPM).

 **WARNING**

Danger of Electrical Disturbance
Using the transmitter from the heart rate monitor in conjunction with an electric pacemaker may cause electrical interference and influence the functionality. This could cause a health hazard.
Never use the heart rate monitor together with an electric pacemaker.

WARNING!
Heart rate monitoring systems may be inaccurate. Over exercising may result in serious injury or death. If you feel faint stop exercising immediately.

7.4.1 Applying the Chest Strap

The transmitter should be applied centrally below the chest muscles. After the belt is fastened, pull it away from the chest by stretching the strap and moistening the conductive electrode strips which are located below the buttons. The transmitter operates automatically while it is worn. It does not work if the connection between the transmitter and the body is broken.



Figure 6- Proper representation of wearing the chest strap safety feature

Positioning

The sensor/transmitter is to be worn below the chest and above the abdomen, preferably directly on the skin (not over clothing), logo to the outside. Moisten the contact surface of the transmitter to transmit the best signal possible from the body to the measuring device.

Cleaning

The chest strap can be washed. Remove belt from the transmitter. Do not bend the electrodes. Wash the strap and electrodes with warm water and mild soap. Do not machine wash the electrodes and do not use alcohol or other harsh cleaning solvents. Since the transmitter can be activated by moisture, it should be wiped dry after cleaning. Never use force to clean the transmitter.

Transmission Signals

The transmitter has a reach of about 3 ft. (1 m). The receiver is in the display. When positioning several treadmills next to each other ensure that a minimum distance between the devices is kept to avoid the interference of the transmission signals between runners. The signal will only be transmitted if the transmitter is within 3 ft. (1 m) of the receiver. Note that variations in the heart rate display can occur when the transmitter is too close to other heart rate measuring devices. Maintain at least 3 ft. (1 m) distance from other devices.



NOTE

It is possible that the heart rate measurement reception is irregular or completely disrupted when the measuring device is too close to strong sources of electromagnetic radiation, for example, near overhead power lines, televisions, computers, electric motors, or other fitness equipment. Only one transmitter should be used within range of a receiver since the receiver might otherwise receive multiple signals and transmit inaccurate readings.

7.5 Display Curve

7.5.1 Curve and Curve Trainer

The battery-operated display seen below is used on the **Curve** and **Curve Trainer**. The display has seven sections that display 11 different items accessible by toggling the "CHANGE READOUT" function key.

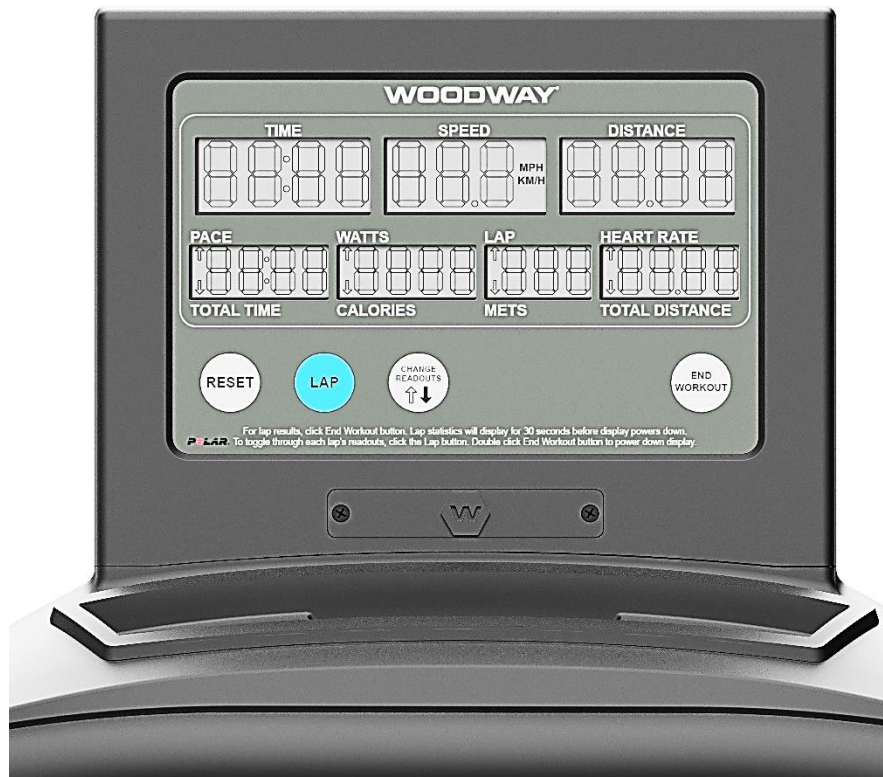

7.5.1.1 Display Parameters

- Manual user speed control
- Display for Time, Calories, Distance, Pace, Watts, Lap, Heart Rate, Total time, Calories, Mets, and Total Distance

7.5.1.2 Description of Display Elements

The indicators in the display indicate the following data:

<i>Speed:</i>	The speed is displayed in 00.0 format. The <i>Speed</i> shows the user's current speed in miles per hour (km/hr if selected for metric readout).
<i>Time:</i>	The time is displayed in 00:00 format and is measure based on the cumulative training time, from start to end. The display stops automatically when no training activity has been detected for 3 seconds.
<i>Distance:</i>	Distance is displayed in 00:00 format and shows the user's accumulated distance in miles and yards (KM and Meters if metric). <ul style="list-style-type: none">• The distance display stops automatically when no training activity has been detected for 3 seconds
<i>Calories:</i>	Calories burnt is displayed in 0000 format. They are calculated using the ACSM formula ($[\text{Workout METs}] * 3.5 * [\text{User's weight in kg.}] / 200$), based on a standard weight of 150 lbs. (70 kg).
<i>Pace:</i>	Pace is displayed in 00:00 format and represents the time it takes to complete a mile.
<i>Lap:</i>	Lap is the current lap the use is on. To increase it, press the <i>Lap</i> function key.
<i>Watts:</i>	Watts are displayed in 0000. They are the instantaneous measurement of power based on the current speed and a standard weight of 150lbs. (70 kg).
<i>Heart Rate:</i>	The user's heart rate (Pulse) is displayed in 000 format. It represents the user's actual heart rate during training in the form of beats per minute.
<i>Total Time:</i>	Total time is the accumulation of time since the workout has started.
<i>Mets:</i>	Mets is displayed in the 00 format. One Met is the energy produced per unit surface area of an average person seated at rest. The increase of Mets is the multiplication of energy expended.
<i>Total Distance:</i>	Total Distance is displayed as 00.00 which measured the accumulation of all miles (or km) over all laps.

7.5.1.3 Function Key Description

Various parameters can be adjusted to your personal training requirements with the function keys. There are four function keys that to use.

<i>Lap:</i>	The <i>Lap</i> button increases the lap count display window while resetting time and display readouts. Lap results can be read in "end workout" section.
<i>Change Readouts:</i>	Switches the readouts between the top display and bottom display. The current readout is shown by arrows on the display screen.

Reset: The *Reset* key resets the display readouts.

End Workout: The *End Workout* button will finish the workout. It will display results of the workout for 30 seconds before powering down. In this mode, the lap button can be pressed to cycle through the results of all laps. The *End Workout* button can be pressed a second time to power off the display.

7.5.2 Curve FTG

The Standard Screen on the **Curve FTG** can be seen below. The display is powered through the wall outlet. It has the same readouts above with an addition readout of "LOAD." There are also 2 additional buttons that increase and decrease the load respectively.



7.5.2.1 Display Parameters

- The FTG standard display uses the same parameters as above.
- There is an addition of load readout.

7.5.2.2 Description of Display Elements

See Above for the general description of display Elements.

Load: The Load readout is used to indicate what level of resistance is currently being used. When the load is changed. A number ranging 0-20 will appear in the

Mets/Load window. After a few seconds, the Load readout will switch back to the current Lap or Mets. To view the resistance level, toggle the load increase and decrease buttons.

7.5.3 Curve, Curve Trainer, Curve FTG Prosmart

Please refer to the Prosmart owner's manual for all features and functions of the Prosmart display on a curve.

7.5.4 Curve XL, Curve 1.5 and Curve 3.0

The battery-operated display listed below is used on the **Curve XL**, **Curve 1.5**, and **Curve 3.0**.

There are five indicators in the display which show program statistics in three or four-digit displays.

The display also contains three function keys, with which settings can be adjusted or active display fields can be changed.



Figure 7- Curve Display

7.5.4.1 Display Parameters

- Manual user speed control (*Speed*)
- Display for Time, Calories, Distance, and *Pulse* (*Heart Rate*)

7.5.4.2 Description of Display Elements

The indicators in the display indicate the following data:

- Speed:* The speed is displayed in 00.00 format. The *Speed* shows the user's current speed in miles per hour.
- Pulse:* The user's pulse (*heart rate*) is displayed in 000 format. It represents the user's actual heart rate during training.
- Time:* The time is displayed in 00:00 format and is measure based on the cumulative training time, from start to end. The display stops automatically when no training activity has been detected for 3 seconds.
- The training time can be set in advance (see instructions for the function keys).
 - A beep sounds when the present time has elapsed (countdown).
- Distance:* Distance is displayed in 00:00 format and shows the user's accumulated distance in miles.
- The distance display stops automatically when no training activity has been detected for 3 seconds
 - The training distance can be set in advance (see instructions for the function keys).
 - A beep sounds when the preset distance has been reached.
- Calories:* Calories burnt is displayed in 0000 format. They are calculated using the ACSM formula ($[\text{Workout METs}] * 3.5 * [\text{User's weight in kg.}] / 200$), based on a standard weight of 150 lbs. (70 kg).
- The calories that should be burnt in a training session can be set in advance (see instructions for the function keys).
 - A beep sounds when the preset calories has been reached.
- Auto On / OFF:* The display automatically detects the use of the treadmill and the LCD fields display the data when the running surface moves. To reset the values, follow the function key instructions. The display switches off automatically when no training activity has been detected for 8 minutes.

7.5.4.3 Function Key Description

Various parameters can be adjusted to your personal training requirements with the function keys. Note that the display will beep when the *Mode*, *Set*, or *Reset* keys are pressed.

- Mode:* Press the *Mode* key to switch between the display windows and select the window that you want to program:
- Distance

- Calories
- Time

Set: A diamond symbol (·) appears in the upper left corner. This means that changes can be made in this window. If the *Mode* key is pressed, the diamond symbol appears in the next window.

The value selected with the *Mode* diamond is programmed by pressing the *Set* key. Each press of the key increases the value appropriate for the display.

Reset: The *Reset* key resets the time entry in normal mode. The window selected with the *Mode* diamond is also reset.

7.6 Display ECOMILL

The keys on the display panels are membrane-type switches, with which control of the max speed is possible. The emergency switch is a magnetic sensor which detects the presence of a magnet and stops the treadmill immediately when the magnet is removed.

There are 5 indicators in the display which show program statistics. The four or five-digit displays are programmed to display the time in the 00:00 format.

The display also contains a function key, with which active display fields can be changed.



Figure 8- EcoMill Display

7.6.1 Display Parameters

- Display for Time, Calories, Distance, Pace, Heart Rate, and METs
- Actual Speed
 - Displays the current speed the treadmill user is walking/running
- Varies depending on how much force is used
 - Max Speed Setting
- Displays the current maximum speed setting
 - Maximum speed the running belt can spin
- Can be set in 0.1 MPH (km/h) increments from 0 – 15 MPH (24 km/h)

- Can be adjusted to increase (Fast [+] key) or reduce (Slow [-] key) speed

7.6.2 Description of Display Elements

The indicators in the display indicate the following data:

<i>Speed:</i>	The speed is display in 00.0 format. The speed shows the user's current speed in miles per hour (MPH) or kilometers per hour (km/h). Valid speeds are 00.0 to 15 MPH (24.0 km/h).
<i>Time:</i>	The time is displayed in 00:00 format and is measured based on the cumulative training time from start to end.
<i>Distance:</i>	Distance is displayed in 00.00 format and is measured based on the cumulative training time from start to end.
<i>Calories:</i>	Calories burnt is displayed in 0000 format. They are calculated using the ACSM formula ($[\text{Workout METs}] * 3.5 * [\text{User's weight in kg.}] / 200$), based on a standard weight of 150 lbs. (70 kg.)
<i>Pace:</i>	The time/miles is displayed in 00:00 format. Pace represents the time required to run one mile at the current speed.
<i>METs:</i>	METs are displayed in 00.0 format and are calculated using the ACSM formula.
<i>Heart Rate:</i>	The heart rate is displayed in 000 format. It represents the user's actual heart rate.

7.6.3 Function Key Description

The keys in the display panel are membrane type switches which allow the user to set the *Max Speed* parameter and to monitor training progress.

ON / OFF: Press the **ON** key to turn the display on and begin the session. Note that the *Max Speed Setting* will be set to the start value. Press the OFF key to end workout and turn off display once workout is completed.

Fast [+] / Slow [-]: Use the Fast [+] and Slow [-] speed keys to set the *Max Speed* for the treadmill. Note that this does not change the speed of the treadmill, only the *Max Speed*.

Pace Cal METs: Press the *Pace Cal METs* key to switch between the display windows for statistics:

- Distance / Calories
- Time / Pace
- Heart Rate / METs

Pause: Press the pause button during a workout to pause the displayed statistics. The statistics will be visible until the workout is ended or the display is turned off. Press pause again to resume workout and resume counting statistics.

7.7 CURVE 1.5 Program

The **Curve 1.5** allows users and trainers to pre-program workouts, track results, and measure progress on the CURVE non-motorized treadmill.

Note: The CURVE 1.5 software is a computer program. The computer itself is NOT included.

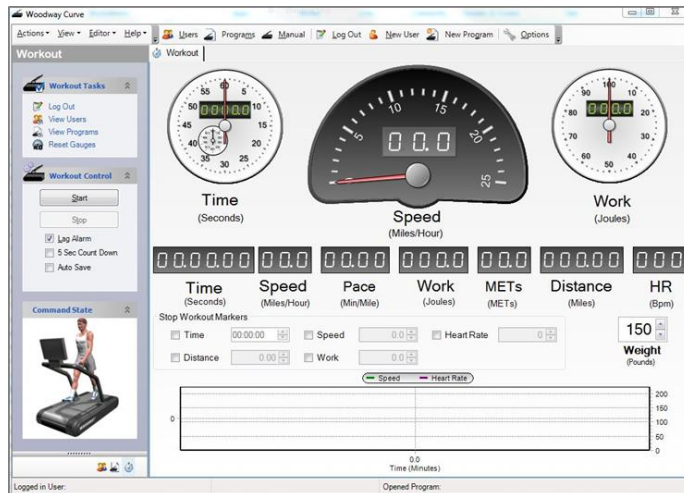

Figure 9- Curve 1.5 Program

7.7.1 Description of Display Elements

The indicators in the program window display the following data:

Time: The time is displayed in both analog / digital clock and 00.00.00 format and is measured based on the cumulative training time from start to end.

Speed: The speed is displayed in both digital speedometer and 00.0 format. Speed represents the user's current speed in miles per hour (MPH) or kilometers per hour (km/h). Valid speed range from 00.0 to the user's max speed.

Pace: Pace is displayed in 00.00 format. It represents the time required to run one mile (kilometer) at the current speed. It is measured in minutes per mile (min/mile) or minutes per kilometer (min/km).

Work: The energy consumption is displayed in both a digital dial and 000.0 format. Work shows the user's accumulated burnt calories, joules, or watt hours. Calories are calculated using the ACSM formula, $([\text{Workout METs}] * 3.5 * [\text{User's weight in kg.}] / 200)$.

If no weight is entered, the energy consumption is calculated based on a standard weight of 150 lbs. (68 kg).

METs: METs are displayed in 00.0 format and calculated using the ACSM formula.

Distance: The distance is displayed in 000.00 format. Distance shows the accumulated user's distance in miles, meters, kilometers, feet, or yards. The distance is accumulated until the program is terminated.

Heart Rate: The heart rate is displayed in 000 format. It represents the user's actual heart rate in beats per minute.

7.7.2 Stop Workout Markers

Set personal workout goals that act as a cue for any workout based on the following parameters:

- Time
- Distance
- Speed
- Work
- Heart Rate

Select the check box for one (or more) of the above markers and enter a *Stop Workout* value. Once the *Stop Workout* value is reached, workout data will stop recording and the *Progress Bar* at the bottom of the window will read "100%".

7.7.3 Manual Workout

By using the manual workout option, users can track their workouts without using a set program or training against a set pacer.

1. In the *Workout Control* pane, click *Start*.
2. Begin training. Workout data will accumulate over the training session.
3. Press **Stop** when ending the workout to pause/stop the data collection.

Countdown: In *Workout Control* pane, select this check box to give users a 5-second countdown on the screen to prepare themselves for the start of the workout.

Auto Save: In *Workout Control* pane, select this check box to automatically save workout session data to the default location with the default name.

Note: See section page 57 for instructions on how to edit or rename the saved workout.

7.8 Manage User(s)

7.8.1.1 Create New User

Create a new user simply by clicking the *New User* button in the toolbar.

1. Click the *Users* toolbar button.
2. Click *Create New User* in the *User Tasks* pane.
3. Enter the information on the *Standard* and *Address* tabs and click **OK** to save data.

Note: *Items marked with an asterisk (*) are required*

7.8.1.2 Edit User

Once a user has been created, it is possible to add or edit user details by performing the following:

1. Click the *Users* button to make the *User Tasks* and *User Collection* panes visible.
2. Select *Edit* from the context menu or select *Edit This User* from the *User Tasks* pane.
3. Make the appropriate changes and click **OK** to save the data.

7.8.1.3 Delete A User

This permanently deletes a user and all associated records from the system. There are multiple ways to delete a user.

1. Click the *User* button to make the *User Tasks* and *User Collection* panes visible.
 2. Right click the named user in the *User Collection* pane.
 3. Select *Delete* from the drop down context menu.
- Note:** *You may also delete the selected user by pressing the 'Delete' key on your keyboard.*

Alternate steps to delete a user:

1. Select *Delete This User* from the *User Tasks* pane.
2. Select **YES** from the pop up prompt window.

7.8.1.4 Log in a User

Before starting a training session for a specific user, the user will need to be logged into the program in one of the following ways:

1. Click the *Users* button to make the *Users Tasks* and *User Collection* panes visible.
2. Right click the named user in the *User Collection* pane.
3. Select *Log in* from the context menu.
4. Double click the name or press *Enter* on the keyboard to log in.

Alternate steps to log in a user

1. Select the named user from the *User Collection* pane.
2. Click *Log This User In*, in the *User Tasks* pane. The name of the logged in user will be displayed in the bottom left corner of the status bar.

7.8.1.5 Log Out a User

After finishing a training session for a specific user, the user should be logged out of the program in one of the following ways:

1. Click the *Log Out* toolbar button.
2. Close out of the program or log in a new user.

Alternate steps to log out a user:

1. Click the *Users* button to make the *User Tasks* and *User Collection* panes visible.
2. Click the name of the user you wish to log out in the *User Collection* pane.
3. Select *Log Out* from the *User Tasks* pane. The name of the user will be removed from the status bar.

7.8.2 Custom Programs

Users can create personalized workout programs with variable stages in the program.

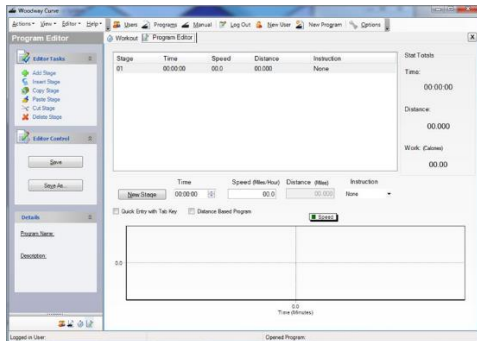

7.8.2.1 Create New Program

The program editor allows you to create a personalized workout program, composed of one or more stages. Each stage includes a length of time, speed, load, and type of instruction (i.e. Sprint, Run, Jog, Walk, None).

1. Click the *New Program* toolbar button or click the *Programs* toolbar button and select *Create New Program* from the *Program Tasks* pane.
2. Enter numerical values in the *Time*, *Speed*, and *Load* list boxes, and select a desired instruction from the drop-down list. To add a new stage, click the *New Stage* button. (Note: values can also be adjusted by clicking and dragging the bars of the graph)
3. Right-click anywhere in the *Program Editor* window to open the context menu. Here you can perform additional actions with the following:

Add Stage	Insert new black stage at the end of your list of stages
Insert Stages	Insert new blank stage at any position in your list of stages
Copy Stage	Copy a selected (highlighted) stage
Paste Stage	Paste a copied or cut stage into the PROGRAM EDITOR window in the desired positions
Cut Stage	Cut or remove a selected stage from the PROGRAM EDITOR window
Delete Stage	Permanently delete a selected stage

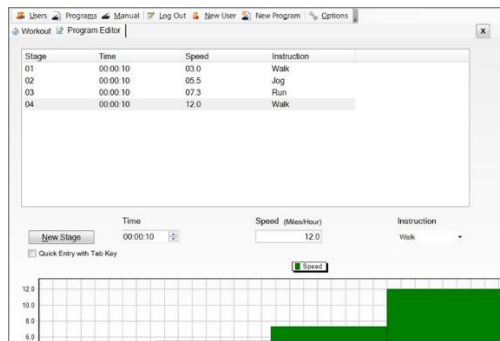

7.8.2.2 Saved Program

When you are ready to save a new program or edited program with additional details, perform the following:

1. Click *Save As* in the *Editor Control* pane.
2. Enter a program name and, if desired, a description.

The program name and description are now visible in the *Details* pane and you can access the program from the *User Collection* pane (if necessary, expand the tree by clicking the [+] sign to access the program).

7.8.2.3 Edit Program

Any modifications to a program will be automatically applied to all programs of the same name that are linked to other users.

1. Click the *Programs* toolbar button.
2. Right-click the program you wish to edit from the *Programs* pane and select *Edit Program* from the context menu.

Alternate steps to edit a program:

1. Click the *Users* toolbar button.
2. Right-click the program you wish to edit from the *User Collection* pane and select *Edit Program* from the context menu.

Note: Values may also be adjusted by clicking and dragging the bars of the graph

3. Enter numerical values in the *Time*, *Speed*, and *Load* list boxes
4. Select a desired instruction from the drop-down list.
5. Add a new stage by clicking the *New Stage* button.
6. Save the changes to the program.

7.8.2.4 Rename Program

Once a program has been created and named, it is possible to rename it. The new name will be automatically applied to all programs of the same name that are linked to other users.

1. Click the *Programs* toolbar button.
2. Right click the program you wish to rename from the programs pane and select rename in the context menu.
3. Type the new name and press enter.

Alternate steps to rename a program:

1. Click the *Users* toolbar button.
2. Right-click the program you wish to rename from the *User Collection* pane.
3. Click *Rename* in the context menu.
4. Type the new name and press *Enter*.

7.8.2.5 Link Program

Linking a program allows you to associate any program with any user. A user can have more than one program, and the same program can be linked and used by different users.

1. Click the *Users* toolbar button.
2. Log in the user who will be the "recipient" of the linked program.
3. Click the *Programs* toolbar button.
4. Right-click the program you wish to link from the list in the *Programs* pane and select *Link Program* from the context menu.

Note: you may also select *Link This Program to Logged in User* from the *Program Tasks* pane

7.8.2.6 Remove Program

Removing a program is different from deleting a program. Removing a program causes the program to be removed from the *User Collection* pane but not from the *Programs* pane. Remove a program when you wish to remove a specific program for a user but retain it in the list of programs for future use.

1. Click the user toolbar button.
2. Right click the program in the user collection pane and select remove program from the context menu.

Note: You may also select *remove this program from user tasks* pane.

3. A message will be displayed, reminding you that the program will only be removed from the user's contents but not from the program list.
4. Click **YES** to remove the program from the user.

7.8.2.7 Deleting a Program

When a program is deleted, it and all references will be permanently deleted from the database, from the programs pane and from all the users who are linked to the program.

1. Click the programs toolbar button.
2. Right click the program you wish to delete and select delete program from the context menu.

Note: You may also select delete this program from the program tasks pane.

3. Click yes in the pop up prompt.

7.8.2.8 Run Program

Once a program has been created, any user linked to the program can run it by performing the following:

1. Click the PROGRAMS toolbar button.
2. Right-click the program you wish to run from the PROGRAMS pane and select RUN PROGRAM from the context menu.
3. Double-click the program name or press ENTER on the keyboard to open the WORKOUT pane and run the program.



Note: Note: you can also run the program by clicking *Run This Program* in the *Program Tasks* pane



Alternate steps to run a program:

1. Click the *Users* toolbar button.
2. Expand the tree in the *User Collection* pane by clicking the [+] until you reach the program you wish to run.
3. Right-click the program and select *Run Program*.

Note: You may also run the program by clicking *Run This Program* in the *User Tasks* pane

4. Double-click the program name or press *Enter* on the keyboard to open the *Workout* pane and run the program.
5. Click and drag the *Spin* button on the dial to set a value for the brake. You may also enter a value into the text box and press *Enter* on the keyboard.
6. Press *Start* in the *Workout Control* pane to begin running the program.

Lag Alarm		<p>If the LAG ALARM check box is selected, an alarm will sound if a runner falls behind the entered speed for the active stage, alerting the runner to speed up. Once the runner reaches or exceeds the entered stage speed for the active stage, the alarm will shut off.</p>
Stage View		<p>The STAGE VIEW window displays the details of each stage of your program as it runs. It displays the current stage number, stage time, speed, brake, and command name. As one stage ends and another begins, the details of the new stage will update.</p>

Relative Stage Speed		<p>The <i>Relative Stage Speed</i> gauge displays the entered speed of the active stage relative to the current speed of the treadmill belt.</p> $\text{Stage Speed} - \text{Current Belt Speed} = \text{Relative Stage Speed}$
Progress Bar		<p>The progress bar displays the status of the program as it runs</p>

RFID Key Fob

With the optional Key Fob feature, users can log their workouts with an RFID card reader and can access custom programs.

7.8.3 Results

Save Results:

When you save a workout program, the collected data is stored. You can save as many results as you wish. Once you save a result you can run a pace workout, generate a report, or generate a graph from the collected data.

End Program:

When the program finishes, a window will appear asking if you wish to save the collected data results. By default, the *Result Name* will consist of the date and time of the workout. However, you can enter any name you wish in the *Result Name* text box. You may also enter any additional information in the *Notes* text box.

Check the *Generate Graph Now* check box and the *Generate Report Now* check box to generate a graph and a report immediately after the workout is saved.

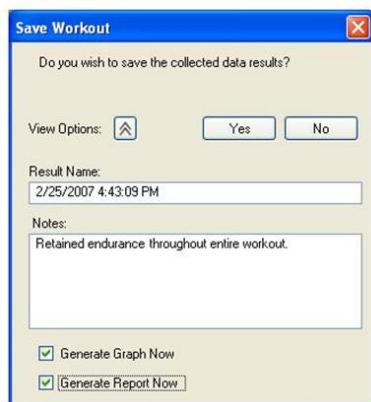

7.8.3.1 Access Results Rename Results

Expand the *Results* folder in the *User Collection* pane to access saved workout results. After saving a workout, it is possible to rename and personalize the data to distinguish it from previous and/or subsequent workouts.

1. Click the *Users* toolbar button to open the *Users* pane.
2. Expand the *Results* folder in the *User Collection* pane to access saved results.
3. Right-click the result you wish to rename.
4. Click *Rename* in the context menu.
5. Type the new name and press *Enter* on the keyboard.

7.8.3.2 Delete Results

It is possible to delete results from a previously saved workout. This will delete record of the workout from the user's activity results.

1. Locate the result you wish to delete by expanding the tree in the *User Collection* pane.
2. Right-click the result and select *Delete Result* from the context menu.
3. Click **YES** to confirm the deletion of the specified result.

7.8.4 Generate Report







Generate a report to view more detailed data collected from the saved workout or executed program.

1. Expand the *User Collection* pane until you reach your desired workout results.
2. Right-click the selected result and select *Generate Report*.

The report that is displayed in the *Reports* window contains all the recorded data from the program you executed. The data contained in the report includes the following:

- Result name
- User name
- Date and time of workout
- Total time (seconds), distance (miles), and work (joules)
- Average heart rate (BPM), speed (MPH), power (watts), and force (lbs.)
- Peak heart rate (seconds), speed (seconds), power (seconds), and force (seconds)
- Notes (information optionally provided when the workout was saved)

When viewing the report, use the toolbar buttons to change views or carry out the following tasks:



Refresh report		Reset report properties to default
Print		Print reports
Zoom / Print Layout		Return view to print layout if previously zoomed
Page Setup		Change page setup properties
Save		Download and save the report as an Acrobat (PDF) file or export to Microsoft Excel spreadsheet
View	Page Width 	Change size of report as it is viewed



7.8.4.1 Generate Graph

Create graphs to visualize a selected workout individually or for comparison over multiple workouts.

1. Expand the tree in the *User Collection* pane to find a specific result.
2. Right-click the result and select *Generate Graph* from the context menu.
 - It is possible to generate multiple graphs for comparison.
 - Newly generated graphs are always populated in the "Graph 1" (top) position.
 - Other graphs are shifted downward into other positions as successive graphs are generated.
 - As you move the mouse over parts of the graph, values are dynamically updated to reflect changes in lines.
 - Click and drag the mouse to create a box around a specific area of the graph, then release to zoom in.
 - The entire graph can be repositioned by clicking and holding the right mouse button and dragging the graph to the desired location.

Refresh		Reset graph properties to default
Print		Print graph(s)
Split window	<input checked="" type="checkbox"/> 	Check to display two graphs at the same time



7.8.4.2 Export to Excel

The *Export to CSV* task allows you to export result records to a CSV (comma separated value) file which can then be opened in Microsoft® Excel.

1. Right-click the result you wish to export.
2. Click *Export To CSV*. The default Excel file name will be the same as in the CURVE program.
3. Open Microsoft® Excel.
4. In Excel, click the *File* tab and then click *Open*. The *Open* dialog box will appear.
5. In the drop-down list, select *Text Files*.
6. Locate and double-click the results file you want to open.
7. Excel will automatically open the file and display the data in a new workbook.

7.8.5 Pacer Function

The integrated *Pacer* function allows users and trainers to save a workout and use it later as a pacer. The pace workout compares distance at the same point in time as the result you ran the pace workout against.

7.8.5.1 Pace Distance

Pace Distance represents the distance from the previous runner that created the recorded result at the same point in time.

7.8.5.2 Relative Distance

Relative Distance, as labeled on the gauge, is the distance between the person currently running and position of the previous runner that created the recorded result at the same point in time. The odometer displays your current relative position.

- Negative value: indicates that current runner trails the previous runner that created the recorded result
- Positive value: indicates that current runner is leading the previous runner that created the recorded result

7.8.5.3 Pace Brake

The *Pace Brake* displays the level of resistance set by the brake.

7.8.5.4 Run Pace Workout

If you would like to run a pace workout against a previously recorded workout, perform the following:

1. Open the *Results* folder in the *User Collection* pane to access the result you wish to run a pace workout against.
2. Right-click the result and select *Run Pace Workout*.
Note: You can also select *Run Pace Workout* from the *User Tasks* pane.
3. Double-click the result name or press *Enter* on the keyboard to run the pace workout.
4. Press **START** in the *Workout Control* pane.
 - If the *Lag Alarm* is selected, when the distance of the runner falls below that of the previous runner, the alarm will sound alerting the runner to speed up.
 - Once the runner reaches or exceeds the distance of the previous runner, the alarm will shut off.
 - The progress bar displays the status of the result as it runs.

When the program finishes, a window will appear asking if you wish to save the collected data results. By default, the *Result Name* will consist of the date and time of the workout. However, you can enter any name you wish in the *Result Name* text box. You may also enter any additional information in the *Notes* Text box.

Check the *Generate Graph Now* check box and the *Generate Graph Now* check box to generate a graph and a report immediately after the workout is saved.

7.8.6 Change Settings

The user has the option to change several of the program's settings. These settings are made accessible by clicking the *Options* toolbar button to open the *Options* tab.

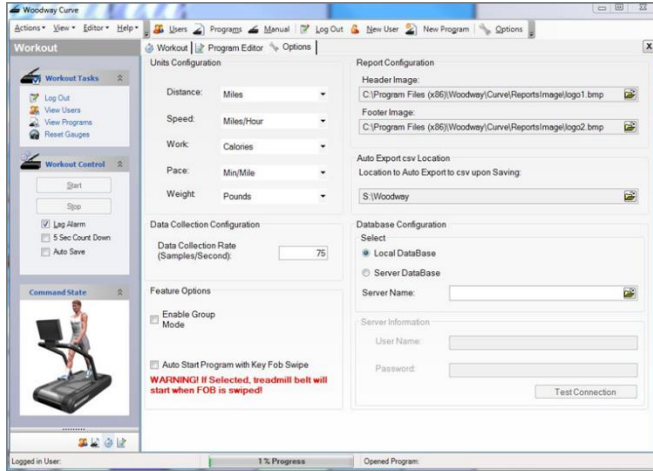

Distance: The distance is displayed in 000.00 format. *Distance* shows the accumulated user's distance in miles, meters, kilometers, feet, or yards. The distance is accumulated until the program is terminated.

Speed: The speed is displayed in 00.0 format. *Speed* represents the user's current speed in miles per hour (MPH) or kilometers per hour (km/h). Valid speeds range from 0.0 to the user's max. speed.

Work: The energy consumption is displayed in 000.0 format. Work shows the user's accumulated burnt calories, joules, or watt hours. Calories are calculated using the ACSM formula, $([\text{Workout METs}] * 3.5 * [\text{User's weight in kg.}] / 200)$.

If no weight is entered, the energy consumption is calculated based on a standard weight of 150 lbs. (68 kg).

Pace: Pace is displayed in 00.00 format. It represents the user's actual (i.e. not average) time to run one mile/kilometer and is measured in minutes per mile (min/mile) or minutes per kilometer (min/km).

Weight: The user's weight can be adjusted to provide a more accurate energy consumption calculation. If this is not adjusted, the default is 150 lbs. (68 kg).

<i>Data Collection Rate:</i>	Manually set the rate (samples per second) at which data is collected during a workout. The greater the number of samples per second, the greater the accuracy of the reports. The default is set to 75.
<i>Enable Group Mode Auto Start:</i>	<p>Select this check box when having multiple runners train in a single session.</p> <p>Select the <i>Auto Start Program with Key Fob Swipe</i> check box to speed up the program-starting process. If selected, the workout program will begin immediately after the user's key fob is swiped.</p>
<i>Report Configuration:</i>	Select personalized header and footer images from your computer or network to be added to generated data reports.
<i>Auto Export CSV Location:</i>	Change the default file location to auto-export saved and downloaded CSV files to upon saving.
<i>Database Configuration:</i>	If saving workout data, programs, and/or user information to a local or server database, select the appropriate database type and name (if applicable).

7.9 CURVE 3.0 Program

The **Curve 3.0** Pacer Performance System program allows users and trainers to pre-program workouts, track results, and measure progress on the **Curve** non-motorized treadmill.

***Note:** For the Curve 3.0, the computer is included.*

7.9.1 Introduction

Innervations has developed the Pacer Performance System Software for the latest athlete powered treadmills. The combination of state of the art non-motorized treadmill with powerful Windows software provides a testing and training system with stunning capabilities. The system is fully programmable and programs can be saved and recalled at will. This permits development of very specific continuous and interval training protocols which mimic the target sport. The Pacer function allows athletes and coaches to save a run and then call it up later to act as a pacer. This means the athlete can "race" themselves, or at least their performance from say 6 months previously. Alternatively, the athlete can race other athlete performances.

A tachometer mounted on the treadmill drum continuously records distance traveled. From this continuous velocity time data is calculated. A horizontally mounted force transducer permits measurement of propulsive force. Combining distance, velocity and force data actual horizontal work done and power output are calculated. Vertically mounted force transducers record the vertical force applied to the treadmill bed.

7.10 Program Views

The range of views for operation of the system are selected from the tabs at the top of the screen. These include:

<i>Dashboard:</i>	Starting and stopping trials; views of time, distance, speed, force, work and power; see the performance in real time.
<i>Program Designer:</i>	Design programs which set braking levels and give auditory and visual instructions to the athlete.
<i>Graphs:</i>	Graphing of distance, velocity, force, and power.
<i>Report:</i>	Summary report of the last performance including average and peak values.
<i>Options:</i>	Adjust the various settings for system operation including calibration and units of measurement

7.10.1 Dashboard

The dashboard is the main control panel for the system. Here the measurements are displayed in real time during a trial. The progress of the program if running is displayed, and the Pacer function can be used.

To start a trial, click the Start button. Click again to stop the trial or use Trial End Points to set criteria for completion of a trial.

Trials can be saved by clicking the Save Trial button. Trials can be loaded by clicking the Open Trial button.

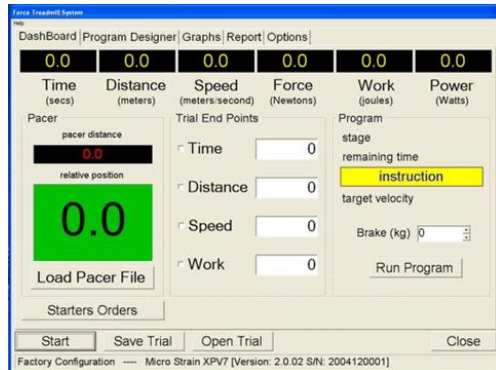

Program

This panel displays the progress of the program if one is running. The current stage, time to the end of the stage and the current instruction is displayed.

Target speed is also displayed. Brake can be adjusted manually. Braking level is in kilograms or pounds (lbs.) depending on the setting of force.

Click the button to start or stop the current program.

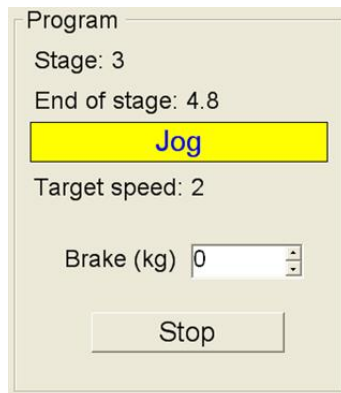

Trial End Points

This panel is where you can set criteria to end the trial. Options include time, distance, speed attained or work done. To set an endpoint, check the box and then enter the target in the appropriate text box. Endpoints can on as many of the options as required with the trial stopping with the first event that occurs.

Units for each setting are as set in the options.

Trial End Points

Time

Distance

Speed

Work

Pacer

This panel displays the progress of the current trial to the pacer file that has been loaded. Pacer distance is the current position of the pacer relative to the start of the trial.

Relative position is the distance between the person currently on the treadmill and the position of the pacer a same point in time. A negative value and red background indicates that the athlete trails the pacer. Appositive and green background indicates that the athlete is leading the pacer.

To load a pacer file, click the button "Load Pacer File". When you click, the Start button the pacer will start at same time.

To create pacer files, simply same any trial file that you wish to use as a pacer in the future.

Pacer

pacer distance

13.1

relative position

-8.0

Load Pacer File

7.10.2 Program Designer

Programs can be designed with a series of stages. Each stage can specify the starting time for that stage, the target speed, the braking load to be applied, the instruction to be displayed on the dashboard, and the sound file to be played to give audio instruction.

Stage: Can be any combination of letters and numbers. It could be a simple series of numbers e.g. 1, 2, 3, etc. or combination of numbers and letters, e.g. 1a, 1b, 1c, 2a, etc. It might be appropriate to use words such as warmup, jog1, sprint1, walk1, jog2, sprint2, walk2 etc.

Start Time: Is the time in seconds from the start of the trial that the stage is to begin. These must be sequential and the time between consecutive stage times is the duration of the stage.

Speed: Is the target speed that the athlete should attempt to match. Speed is entered as a number and the units depend on what is selected on the Options for speed units.

Load: Is the amount of braking that will be applied. Possible settings range from 0 to maximum braking force.

Instruction: Specifies the written instruction to be flashed to the athlete at the start of the stage. This message will be displayed for 4 seconds. Any text can be entered this field. Examples are: walk, run, jog, stop etc.

SoundFile: Specifies the sound to be played at the start of the stage. Several sound files are provided with the program and include: walk.wav, jog.wav, run.wav, finished.wav. The filename must match a .wav file which is in the SoundFiles folder. You can record your own sounds using the Windows Sound program. Just ensure that the files are all kept in the SoundFiles folder so that the system can find them.

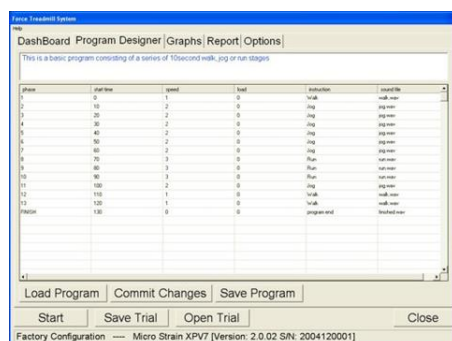

To edit the program just click on a cell and begin typing. Columns, rows or groups of cells can be copied (Ctrl-C) and pasted (Ctrl-V).

Load Program: Click the load button to open a program file.

Commit Changes: Click the commit button to apply any changes made to the currently loaded program.

Save Program: Click the save button to keep your changes or save the program to a new filename.

7.10.3 Graphs

Variables that can be graphed include distance, velocity (speed), power, horizontal force and vertical force. To display a variable, check the box. The color of the line is the same as the color of the variable label. Units of measurement are given on the left or right axis depending which variables are being graphed.

Any section of the graph can be zoomed by holding down the left mouse button and dragging down and to the right over the section of interest. To remove the zoom, hold down the left mouse button and drag up and to the left.

To scroll around a zoomed section of the graph, hold down the right mouse button and move the mouse in the desired direction

7.10.4 Report

The report is a summary of the last recorded trial. The date and time of the test is displayed along with the total distance, average velocity, power and horizontal force. Peak velocity, power and force are also calculated including the time at which they occurred.

Text in the report can be selected and then copied (Ctrl-C) and then pasted (Ctrl-V) into other documents.

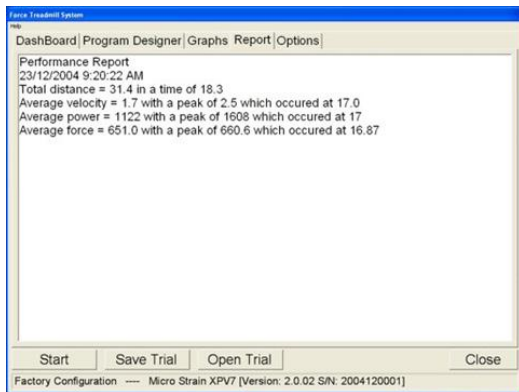

7.10.5 Options

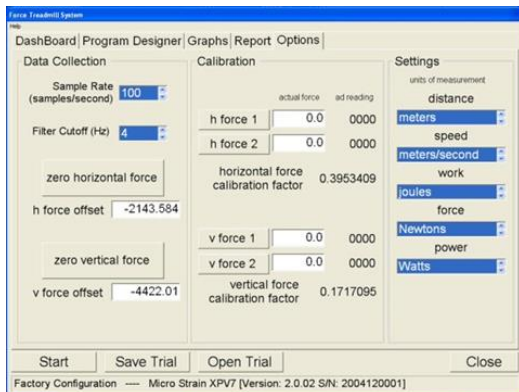

7.10.6 Settings

The settings panel is used to select different units of measurement.

- Distance:* Can be measured in meters, feet, yards, kilometers or miles.
- Speed:* Can be measured in meters/second, feet/second, yards/seconds, miles per hour, or kilometers per hour.
- Work:* Can be measured in joules or foot-pounds.
- Force:* Can be measured in Newtons or pounds.
- Power:* Can be measured in Watts or Horsepower

7.10.7 Data Collection

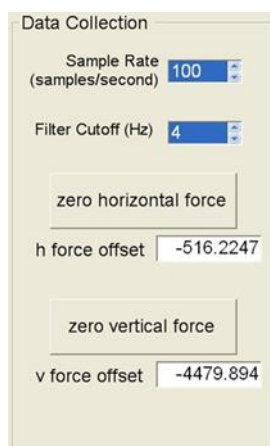

The data collection panel is used to adjust setting which affect the way measurements are made.

Sample Rate: The number of samples that are collected each second. The setting can be from 1 to 200 Hz. The choice of sample rate depends on how long the test duration is and how quickly changes must be measured. For longer trials a sample rate of 10 or less might be selected. If you wish to get accurate measures for say a 10-meter sprint, then 100 or even 200 Hz would be a good choice.

Filter Cutoff: Refers to setting of the digital filter that is applied to the distance-time data before speed-time data is calculated. The filter cutoff must be less than half the sample rate. Selection depends on the sample rate and how much smoothing is required. If the graph of speed appears "noisy" or jagged, then select a lower filter cutoff. Settings from 0 (no filter applied) to 20 Hz are available.

Zero Horizontal Force: Accounts for any zero offset on the horizontal force transducer. If you take some measurements with no force applied to the horizontal transducer and the force is not zero, clicking this button should correct for this in subsequent measurements.

The actual zero offset will be displayed in the text box.

Zero Vertical Force: Accounts for any zero offset on the vertical force transducers. If you take some measurements with no force applied to the tread-mill deck and the force is not zero, clicking this button should correct for this in subsequent measurements.

The actual zero offset will be displayed in the text box.

7.10.8 Calibration

Calibration is a relatively simple process which allows the information from the force transducers to be scaled to an appropriate unit such as New-tons or pounds of force. The distance measurement does not require calibration because it is measured from a toothed wheel which generates pulses when the treadmill drum turns. The distance moved for each pulse is known and does not change and so the conversion factor from pulses to distance in meters, feet etc. is coded directly into the system.

Calibration of the force required the application of known forces to the transducers which measure the force. Two different input forces are required so that a line can be fitted, the slope of which is the calibration factor and the y-intercept is the zero offset. Force can be calibrated in either New-tons or pounds depending on your preference and setting of the units for force.

To calculate the force applied in Newtons multiple the mass of the calibration object by 9.81. For example, if you are using a person's body weight and you weight them on a scale and the weight is 110 kg, multiply by 9.81 and the actual force is 1079 Newtons.

Selection of known forces to use should be deter-mined by the expected range of forces to be measured from the athlete. The first force can be zero, in other words no weight added. The second force should be toward the top of the expected forces to be measured.

Calibration options are accessed by clicking the Options tab.



7.10.9 Calibrating Vertical Force

The vertical force is calibrated by placing weights on the deck of the treadmill.

The first force can be zero in which case there should be nothing on the treadmill deck.

Enter the force applied into the textbox next to the button labeled "v force 1". In the example, we have used zero force as the v force 1 and so enter 0.0.

Ensure that the force entered is applied to the treadmill deck and click the button labelled "v force 1" When the ad reading stabilizes the you can progress to the next stage.

Apply the second force to the treadmill deck. Enter the actual force applied into the textbox next to the button labeled "v force 2"

In the example, we are going to use a person's body weight. We have weigh them using an accurate electronic scale and they are 90.82 kilograms. Converting this to a weight force in Newtons by multiplying by 9.81 gives 891.726 Newtons.

Ensure that the force entered is applied to the treadmill deck and click the button labelled "v force 2" The new vertical force calibration factor will be displayed

Calibration		
	actual force	ad reading
h force 1	0.0	5766
h force 2	1079	8496
horizontal force calibration factor	0.3953409	
v force 1	0.0	21275
v force 2	0.0	0000
vertical force calibration factor	0	



Calibration		
	actual force	ad reading
h force 1	0.0	5766
h force 2	1079	8496
horizontal force calibration factor	0.3953409	
v force 1	0.0	21275
v force 2	891.729	26468
vertical force calibration factor	0.1717095	

In normal use the calibration factors for both vertical and horizontal forces should be quite stable. As such calibration, may only be required every few months. If the data is force scientific use and accuracy needs to be constantly verified, then calibration immediately prior to the test sessions is recommended.

8 Accessories and Services

The following accessories and services are available from WOODWAY:

Protective Treadmill Floor Mat: Protect the flooring or carpeting below your WOODWAY and keep your treadmill clear of obstructions. (i.e. thick or high-pile carpet)

Replacement Safety Magnet:

RFID System with 100 Key Fobs: Available only for **Curve 1.5** and **Curve 3.0**

Preventative Maintenance Kit:

- *Kit includes:*
- *Dry graphite lubricant*
- *Tube of black grease*
- *Canned air*
- *Extension tool with TORX-20 bit*

WOODWAY Renewal Program

This entails having your treadmill shipped back to WOODWAY via Van Line (WOODWAY can coordinate these details; cost is additional). Your treadmill will then be thoroughly renovated by a qualified WOODWAY Service Technician. Any worn/outdated features will be replaced. The treadmill will then carry a one (1) year parts and labor warranty. It's like getting a brand new WOODWAY at a fraction of the cost.

Contact the WOODWAY Service Department or your sales representative to order at 1-800-WOODWAY (1-800-966-3929)

9 Cleaning and Maintenance



WARNING

Danger of Injury due to Lack of Qualifications

- If maintenance or repairs are not carried out by professionally qualified personnel, this may cause material damage and serious injury.
- Maintenance and repair work may only be performed by qualified personnel.
- It is the sole responsibility of the representative to assign qualified personnel for maintenance and repair work.
- Clean and examine the machine regularly for damage and/or wear, paying special attention to areas susceptible to wear.
- In case of doubt or questions, always contact the WOODWAY Customer Service or dealer.
- The manufacturer is not liable for personal injury and material damage caused by a lack of qualifications

9.1 Cleaning



WARNING

Danger of Electrical Shock

- The use of water and liquid detergents as part of cleaning can cause serious or fatal electrical shock.
- No liquids may come into contact with electrical components, wires, wire connections, displays, or ECOMILL battery back-up systems.
- Do not spray the device with a water jet.
- Turn off the ECOMILL battery back-up system prior to any cleaning or maintenance work.

9.2 Instructions

1. The running surface should be thoroughly cleaned at regular intervals, depending on the intensity of use.
2. Remove light dirt and dust with a soft cloth.
Note: Dirt can be removed with damp cloth and mild soapy water.
3. After cleaning, dry with a dry cloth.

9.2.1.1 Cleaning Suggestions to Consider

- Do not use abrasive brushes or abrasive cleaners, as the paint and plastic surfaces can be scratched.
- Do not use sharp tools (e.g. knife, metal scraper) or aggressive solvents for cleaning.
- Clean all surfaces with a mild, non-abrasive detergent.
- To avoid damage to component surfaces, observe the instructions for detergent use.

9.3 Maintenance

When the treadmill is in a dirty area or is heavily used, cleaning and inspection measures must be performed accordingly.

For proper inspection and regular review, we recommend a WOODWAY maintenance contract.



NOTE

Worn or damaged components must be replaced immediately. If the observed defect can cause danger to the user or operator, the treadmill may not be used until it is repaired.

9.3.1 Weekly Maintenance

- Clean the rails, the front display panel, and the cover panels.
- Check the overall condition of the treadmill.
- Vacuum under the treadmill.

9.3.2 Annual Maintenance

- Vacuum the inside of the treadmill. For this, remove the railing and the panels.
- Check all screw connections for tightness. Tighten loose nuts and bolts.
- Tighten set screws to 68 in-lbs.
- Clean the running surface.
- Check the toothed belt. Replace if teeth are missing or the belt is badly worn.
- Lubricate the roller bearings on the front and back.

9.4 Lubrication

9.4.1 Bearings

All bearings in the treadmill have been lubricated at the factory and need not be lubricated except for the axle bearings. The bearings on the front and rear axle are to be lubricated with a grease gun once a year (2 in the front, 2 in the rear). The side panels must be removed for lubrication.

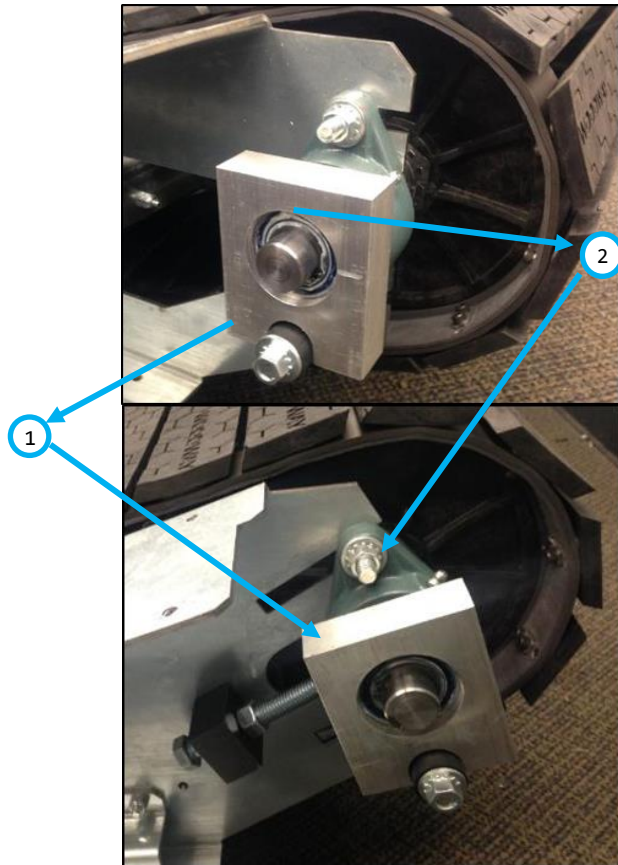

1. One-way bearing
2. Lubrication nipple for all 4 bearings / front and rear axle edges of slats
3. Inside of the running surface belt

9.4.2 Running Surface Belt

The rubbing of the running surface's toothed belt on the edges of the guide roller may cause noises. For relief, lightly lubricate the sides of the toothed belt (Molykote or equivalent). Also, apply lubricant to the teeth on the synchronization belt.

10 Warranty Information

Warranty	Frame	Drive / Motor / Belt	All Components	Labor
Fitness Performance	10 years	5 years (Excluding Blade Skating Surface)	3 years	1 year
Medical	10 years	5 years	4 years	1 year
Home Use	15 years	5 years	3 years	3 years
Refurbished	N/A	N/A	2 years	1 year
International	N/A	N/A	3 years	N/A

WOODWAY warrants that all products and accessories will be free from manufacturing defects per the applications/terms listed above. The warranty period commences on the original date of purchase (with the exception of the running belt component, which is warranted for a period of four (4) years from the original date of purchase). This warranty is given only to the original purchaser. This warranty does not cover damage or equipment failure resulting from misuse, abuse, or failure to comply with electrical codes. Further, this warranty shall not apply if there is any modification to the products or accessories or if there is a failure to provide maintenance as outlined in the Owner's Manual.

WOODWAY GIVES NO OTHER WARRANTIES, EITHER EXPRESSED OR IMPLIED. THE WARRANTY OF FITNESS FOR A PARTICULAR USE IS HEREBY DISCLAIMED.

The buyer's remedy for breach of the expressed warranties contained herein shall be limited to the return of the product and accessories and repayment of the original purchase price. However, provided at WOODWAY selection, it may repair and replace the non-conforming goods or parts. WOODWAY shall not be liable for any incidental or consequential damages.

Our Guarantee

WOODWAY guarantees the repurchase of WOODWAY treadmill products for a period of up to five (5) years after original installation. A direct payment, or credit toward the purchase of a new WOODWAY, of 20% of the purchase price of the treadmill will be made to the original owner of a WOODWAY treadmill. This guarantee is limited to the original owner. Contact WOODWAY for further details.

11 Troubleshooting



NOTE

Except for the maintenance work described in this chapter, the treadmill can only be checked and repaired by qualified personnel.
If necessary, contact the WOODWAY dealer or service center.

If you have problems with your non-motorized treadmill, please consider the answers to the following questions before calling WOODWAY Customer Service:

- What are the make, model, and serial number?
- What happened before the problem occurred?
- Did the problem occur suddenly or slowly over time?
- Was the treadmill in use when the problem occurred?
- Explain any other signs which can provide information for correcting the error.

11.1 Display Will Not Turn On

- Make sure display batteries are properly inserted in battery compartment and facing the correct direction.
- Replace batteries.
- If treadmill is powered by wall outlet, make sure treadmill is plugged in and the Power switch by the power cord is in the on position.
- If the display still does not function properly, contact WOODWAY Customer Service.

11.2 Running Surface Belt is Stuck/Difficult to Move

- Check for any obstacles around or under the belt and remove them if possible.
- Remove side panels and ensure that the belts are properly aligned on rollers.
- Contact a WOODWAY Customer Service technician to determine where the cause of the problem could be.

11.3 Squeaking Sounds

- Bearing: Contact WOODWAY Customer Service to replace bearing.
- Toothed belt rubbing against guide roller: Grease edge of belt with a universal lubricant.
- Broken guide roller or roller bearing: Contact WOODWAY Customer Service to replace broken part.
- Timing belt rubbing against the pulley: Grease the edge of the timing belt with a small amount of all-purpose grease.

Note: Excessive grease can cause clotting and collection of dust.

13 Disposal Notice

13.1 Batteries

Always return used batteries.

Discharged batteries can be returned to public collection or retail stores.

Batteries supplied by WOODWAY can be returned to WOODWAY at no charge. They can also be sent by mail.



Display batteries may not be disposed of in household trash. Dispose of them at a battery collection point.

13.2 Device

The disposal of the equipment must be in accordance with the respective national regulations.

An appropriate waste disposal company should be contacted. Properly dispose of the device at the end of its service life (e.g. the local collection point for waste separation):

- The device packaging is disposed of through resource recycling.
- The metal parts of the machine go to scrap metal disposal.
- Plastic parts are given to plastic recycling.
- Rubber parts are disposed of as hazardous waste.



The disposal of the equipment must be in accordance with the respective national regulations.

Wear parts are considered hazardous waste! After being replaced, wear parts must be disposed of per country-specific waste laws.