

FREEMOTION
Powered By **iFT™**

INTERACTIVE. PERSONAL. TRAINING.

22 SERIES



ASHLEY DAVIS — HAWAII

UPRIGHT BIKE

INCLINE TRAINER



REFLEX™ TREADMILL



ELLIPTICAL



RECUMBENT BIKE



UPRIGHT BIKE

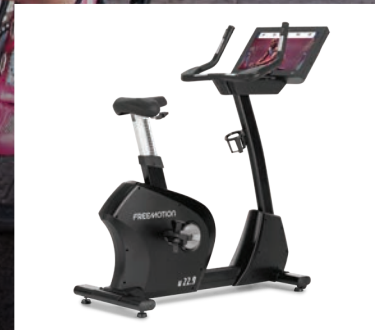

COACHBIKE™



CONTENT

WORKOUT LIBRARY || PG 3

FITNESS COACHES || PG 4

GLOBAL WORKOUTS || PG 5

STUDIO CLASSES || PG 6

GOOGLE MAPS™ || PG 7

TECHNOLOGY || PG 8

PRODUCT BENEFITS || PG 10

PRODUCT FEATURES || PG 11

SPECIFICATIONS || PG 12

WARRANTIES || PG 13

u22.9 UPRIGHT BIKE

THE CARDIO EXPERIENCE REIMAGINED

Exclusively on content-driven cardio machines from Freemotion, your members can explore the world through thousands of coach-led workouts, right from the cardio floor. Powered by iFit, the 22 SERIES keeps users engaged with vivid imagery, motivational coaching, and auto-adjusting technology that delivers an immersive and interactive cardio experience.

Offer your members the consistent, effective, and low-impact cardio solution found on the Freemotion Upright Bike, while allowing them to cycle the world, right from the cardio floor.

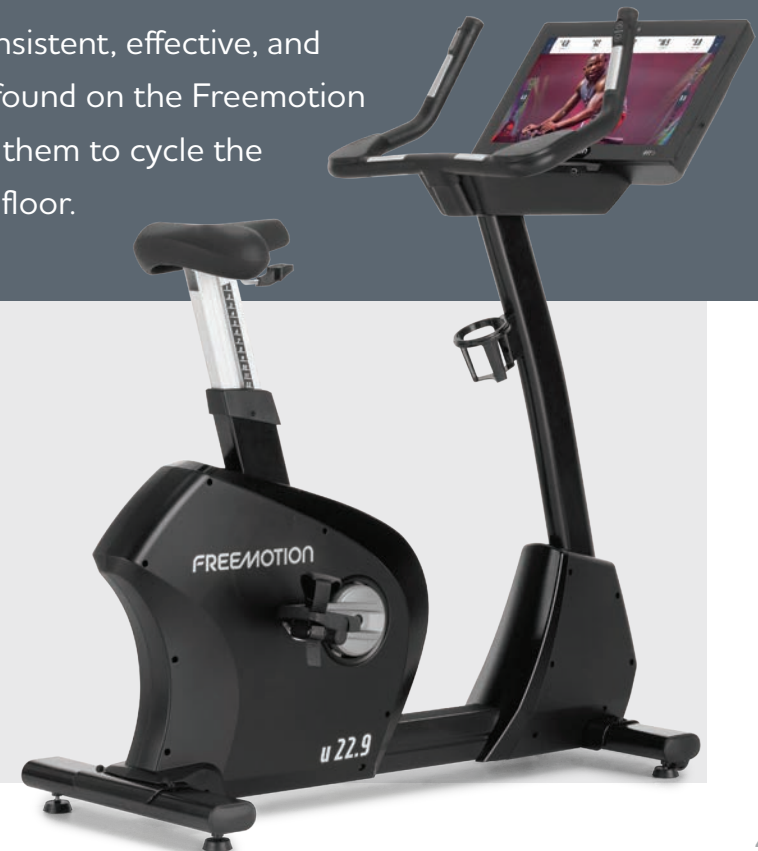



THOUSANDS OF COACH-LED
WORKOUTS

Access an expansive library of on-demand workouts led by expert fitness coaches from around the world. Search or sort by location, trainer, exercise type, workout duration, intensity, and more!

WORLD-RENOWNED

FITNESS COACHES

We've hand-selected 100+ Olympic champions, celebrity trainers, physical therapists, professional cyclists, and location guides to be your iFit coaches. With unique training styles and personalities that motivate and inspire, you'll quickly find your new favorite trainer.



INTERACTIVE. PERSONAL. TRAINING.

GLOBAL WORKOUTS

Explore the world without leaving the room with thousands of inspiring training videos beautifully filmed in stunning locations around the globe, including 40+ countries and all 7 continents. Your bike's resistance will even adjust to match the terrain and instructions of your coach.



Travel the World

Virtually travel to unique locations with guides that share facts, information, and history that transform your workout into an engaging and educational experience.



Workout in Breathtaking Locations

Explore the islands of Hawaii, cycle the streets of Paris, or push yourself in the Alps with an exciting and immersive fitness experience.

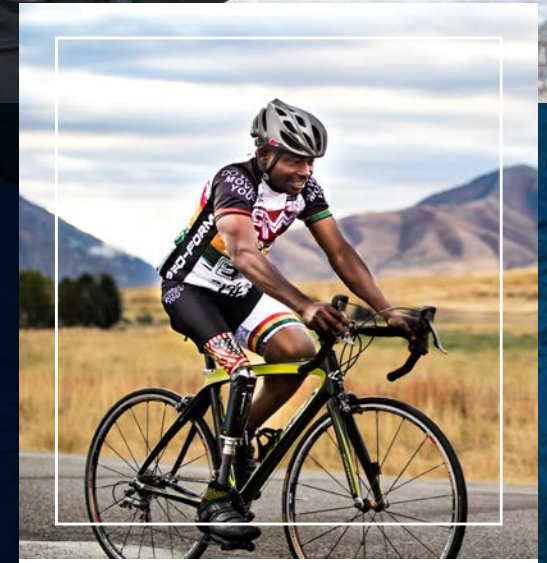

Participate in Iconic Races

Challenge yourself by virtually participating in iconic races like the Tour de France right from the cardio floor.

INTERACTIVE. PERSONAL. TRAINING.

STUDIO CLASSES

Experience the hype of a high-intensity studio class alongside other participants and taught by fitness instructors that motivate and inspire you to finish strong. Let your coach guide you through the workout and virtually control your bike.



Gideon Akande
STRONG & LEAN SERIES



Chris Clark
CARDIO-BLASTING BURNOUT



Nicole Meline
DREAM CHASER SERIES

ANJA GARCIA - IFIT STUDIO



EIFFEL TOWER - PARIS, FRANCE

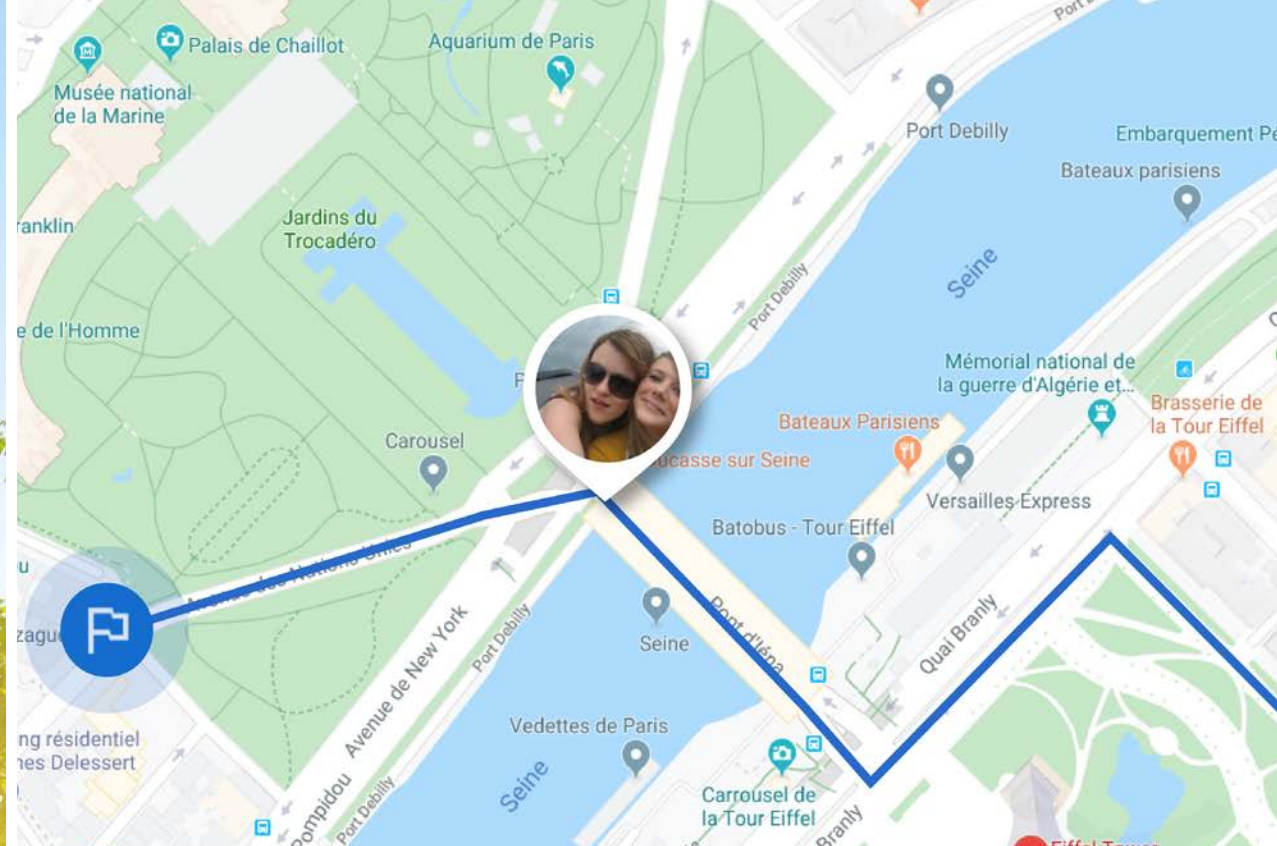

INTERACTIVE. PERSONAL. TRAINING.

GOOGLE MAPS

Ride anywhere in the world with Google Maps. Create a route, and iFit will adjust your bike's resistance to match the on-screen terrain, allowing you to virtually explore 10 million miles (16 million km) of mapped locations. Revisit your childhood neighborhood or train for an out-of-town race (5K, marathon, etc.) before completing it in person.

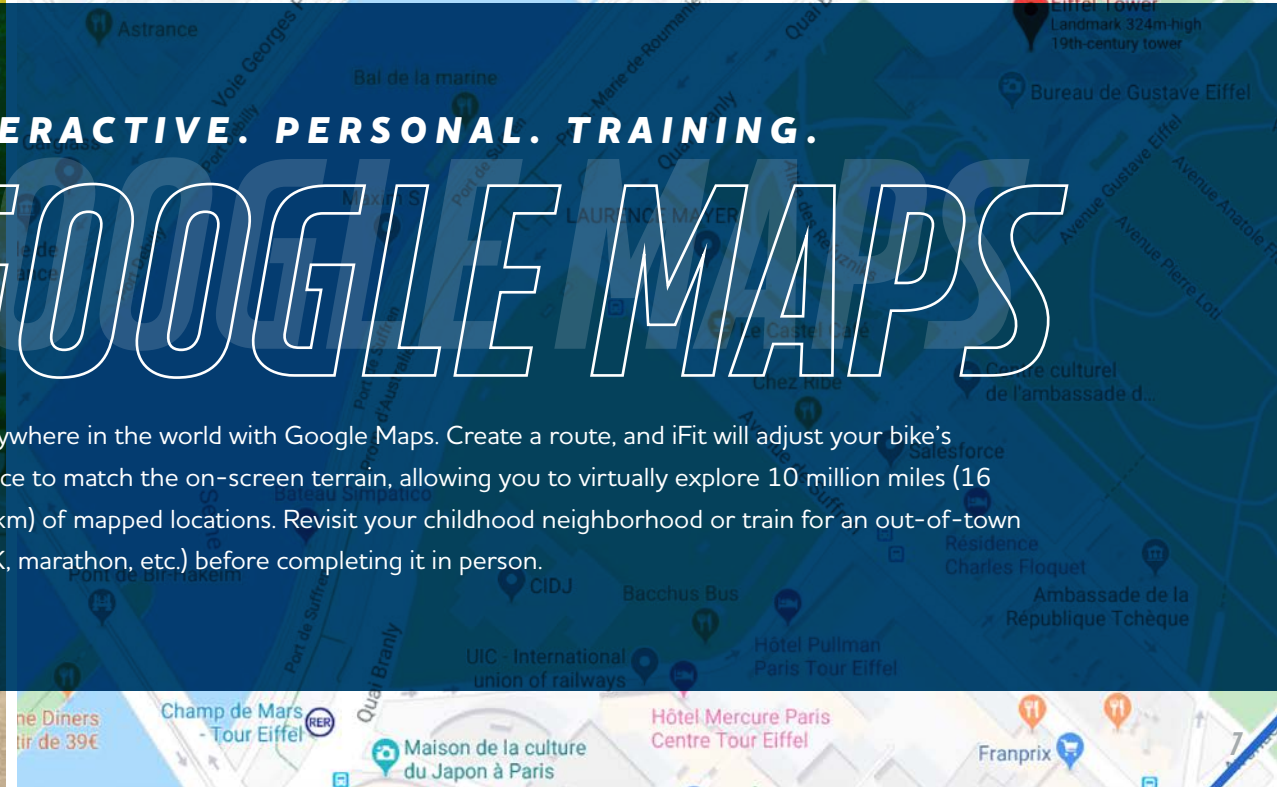

I'M GOING TO INCREASE
YOUR RESISTANCE!

AUTO-ADJUSTING

TECHNOLOGY

Each interactive workout allows your coach to remotely adjust the resistance of your bike to mirror the on-screen content, creating an immersive and engaging training experience.



ASHLEIGH MCCLVOR — WHISTLER, BRITISH COLUMBIA

CONTENT ON-DEMAND, 24/7

Get access to your favorite fitness coach on your schedule, whenever you choose to workout.

ADVANCED WORKOUT METRICS

Never lose sight of your personal fitness goals with real-time metrics that go beyond traditional feedback, leveraging heart rate, intensity, and more to measure and track your fitness journey.

PROGRESSIVE WORKOUTS

Complete a full workout series that continuously challenges with each new workout.

EVER-EXPANDING CONTENT LIBRARY

With an extensive and ever-growing library of engaging on-screen content, you'll always have a new workout to experience or a unique location to explore.

PRODUCT

BENEFITS

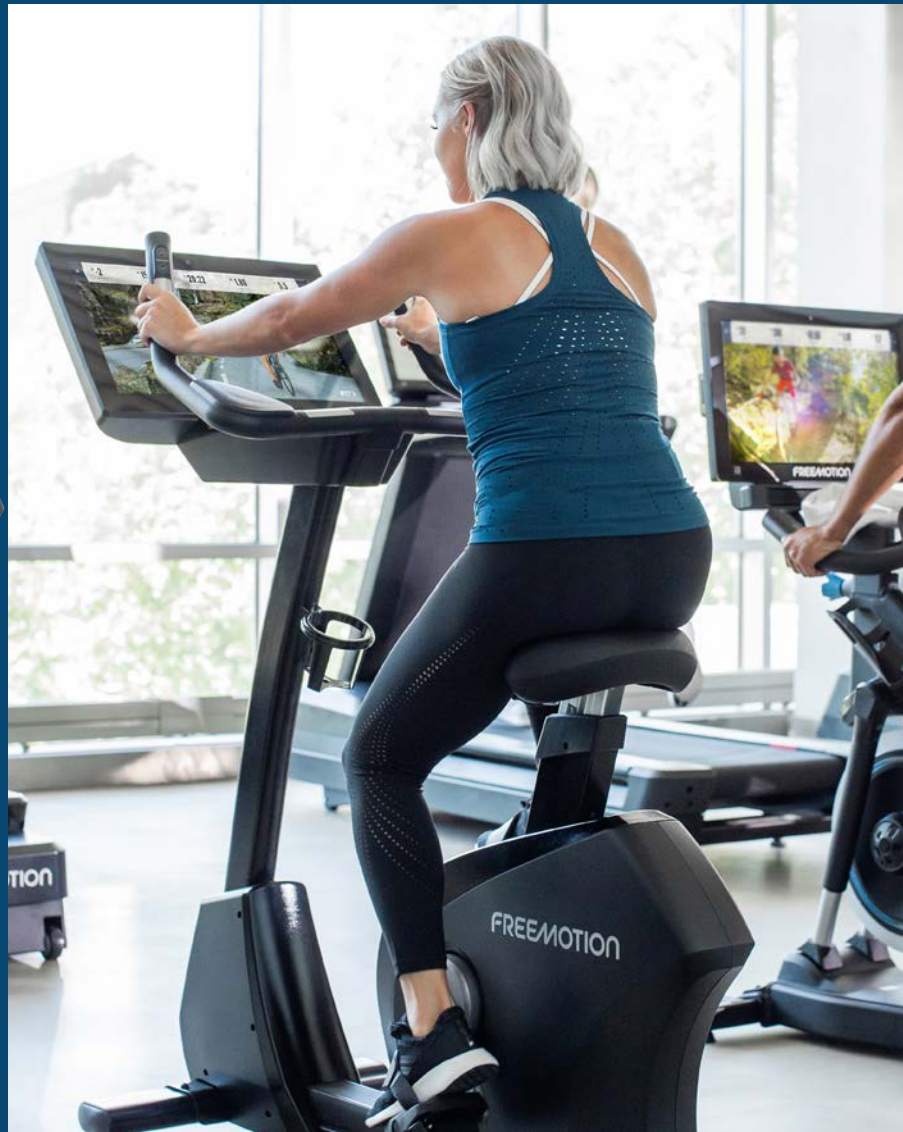

CONSISTENT CYCLING SOLUTION

From the Quicklift™ Overmolded Seat to the Step Thru™ design, this bike is poised to be your go-to cardio solution. Give yourself a consistent and efficient cardio experience by choosing between sitting down and starting to pedal or exploring the world with your favorite trainer through thousands of coach-led workouts.

u22.9 UPRIGHT BIKE

PRODUCT

FEATURES

ACCESSIBLE AND ENGAGING SOLUTION

Participate in the high-intensity studio classes you've been wanting to attend but may not have felt comfortable joining because the equipment accessibility. With a Step-Thru™ design and ergonomically engineered seat, you have the equipment to thrive.

LOW-IMPACT CARDIO

Treat your joints to a low-impact cardio workout while engaging your muscles, heart, and mind in a stimulating and effective workout.

AUDIO-ENHANCED EXPERIENCE

Deeply immerse yourself in your workout with an enhanced audio experience when connecting via Bluetooth or headphone jack.

u22.9 UPRIGHT BIKE



HIGH-DEFINITION DISPLAY

Immerse yourself in visually stunning imagery while working out in exotic locations around the globe on this high-definition 22-in (55 cm) capacitive touchscreen.



ON-THE-FLY ADJUSTMENTS

Override or adapt the programming to meet your needs by quickly adjusting the bike's resistance with controls conveniently placed directly on the handlebars.

KNOW YOUR ZONE

Get real-time data during your workout with built-in EKG grips, so you know when you're in the ideal heart-healthy zone. Also compatible with ANT+ and Polar®.

PRODUCT

SPECIFICATIONS

MODEL # FMEX82420 || FMEX82420-INT

Display Type	22 in (55 cm) HD Capacitive Touchscreen Built-in TV Tuner* (Available Soon)
Workouts	Thousands of Coach-Led, Unlimited with Google Maps
Featured Languages	EN, also DE, ES, FR, IT, PT, RU, ZH
Entertainment	HDMI, MPEG-2, MPEG-4 US & Canada: H.264 (AVC) International: H.265 (HEVC)
Electronic Readouts	Speed, Resistance, RPM, Distance, Calories, Time, Heart Rate, Watts and Pace
Audio Connections	Bluetooth, 3.5 mm headphone jack
Connectivity	Ethernet or Wifi minimum: 10 Mbps per unit (Dedicated Ethernet recommended)
Resistance System	SMR™ Silent Magnetic Resistance
Resistance Levels	1-24 Levels
Heart Rate Monitoring	Dual-Grip EKG Pulse Sensors, ANT+ and Polar Compatible
Accessories Holder(s)	Phone/Accessories Tray, Bottle Holder
Transport Wheels	2 in (5 cm) Plastic Wheels
Supported Power	120 VAC, 2 Amp 240 VAC, 1 Amp
Maximum User Weight	400 lbs (182 kg)
Product Weight	176.4 lbs (80 kg)
Product Dimensions (L x W x H)	53 x 24 x 58 in (134.6 x 60.9 x 147.3 cm)
Shipping Weight	206 lbs (93.4 kg)
Shipping Dimensions (L x W x H)	52 x 15.4 x 33 in (132 x 39 x 83.8 cm)
Certifications	CE, FCC/IC, BQB

*NTSC, PAL, SECAM etc.

For the full list of specifications, visit freemotionfitness.com

22 SERIES

u22.9 UPRIGHT BIKE

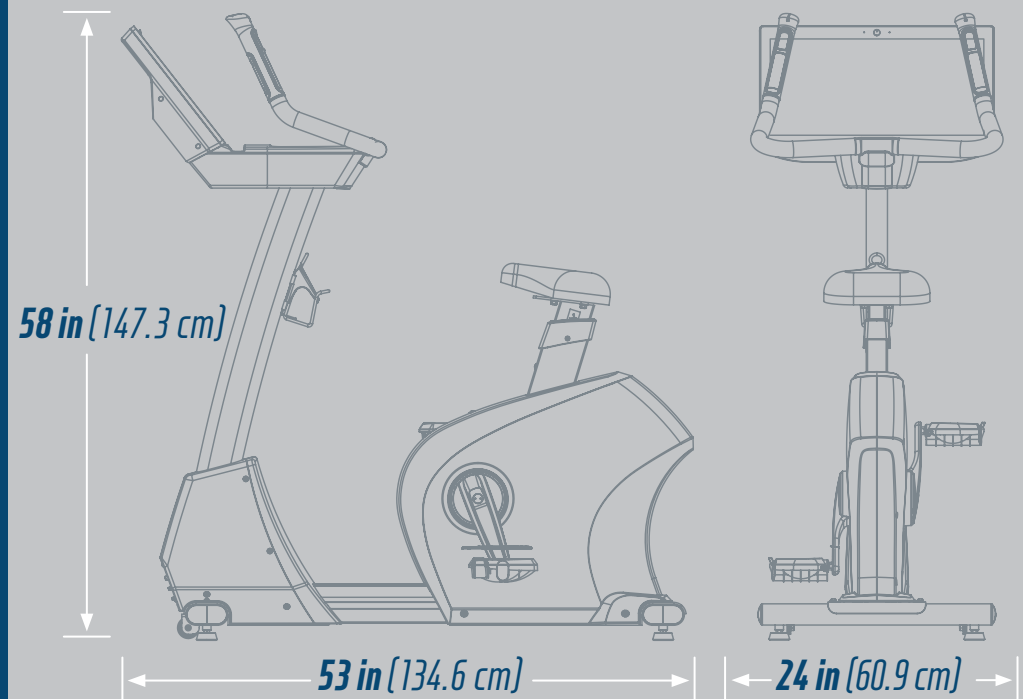

ELECTRICAL POWER

This bike can be powered by a standard 15 Amp Circuit. A maximum of five (5) bikes may be run safely on a single circuit.

NETWORK CONNECTIVITY

Although WiFi compatible, a dedicated ethernet with a minimum bandwidth of 10 Mbps per unit is highly recommended.

CARDIO: HIGH-USAGE - 22, 10, & 8 SERIES	US & CANADA	INTERNATIONAL
Frame (not including coatings), Drive Motor	7 Years	7 Years
Parts and Console	2 Years	2 Years
Labor	1 Year	1 Year
Cosmetic & Wear Items*	6 Months	6 Months
CARDIO: LOW-USAGE - 22, 10, & 8 SERIES**	US & CANADA	INTERNATIONAL
Frame (not including coatings), Drive Motor	7 Years	7 Years
Parts and Console	3 Years	3 Years
Labor	3 Years	1 Year
Cosmetic & Wear Items*	6 Months	6 Months
TV ATTACHMENTS	US & CANADA	INTERNATIONAL
MYE Digital LCD TV	3 Years	3 Years
MYE TV Controller & Wireless Receiver	2 Years	2 Years
MYE Wireless Transmitter	5 Years	5 Years
INDOOR BIKES	US & CANADA	INTERNATIONAL
Frame (not including coatings)	7 Years	7 Years
Belt	5 Years	5 Years
Parts and Console	2 Years	2 Years
Labor	1 Year	1 Year
Cosmetic & Wear Items*	6 Months	6 Months
FUSION	US & CANADA	INTERNATIONAL
Frame (not including coatings)	10 Years	10 Years
Parts	2 Years	2 Years
Ropes and Labor	1 Year	1 Year
Cosmetic & Wear Items*	6 Months	6 Months
STRENGTH/BENCHES/RIGS/RACKS/ATTACHMENTS	US & CANADA	INTERNATIONAL
Frame (not including coatings)	10 Years	10 Years
Parts	3 Years	3 Years
Cables and Labor	1 Year	1 Year
Cosmetic & Wear Items*	6 Months	6 Months
Upholstery & Padding	120 Days	120 Days
FREE WEIGHTS	US & CANADA	INTERNATIONAL
Urethane-coated Weights (repair or replace at our discretion)	3 Years	3 Years
Rubber-coated Weights (repair or replace at our discretion)	2 Years	2 Years

*Includes Non-warning Decals, Deck Rails, Pulse Grips, USB, Audio Jack, Handrails, Motor Hood, Fan Levers, Water Bottle Holders, Pedals, Pedal Straps, Seats, Handles/Levers/Knobs, Hand Grips, Removable Trays, Weight Pins, Springs, Belts (except Walking Belts), Accessories, Rust on Any Metal Components.

**For non-dues paying facilities with machine usage of 6 hours or less per day.

FREEMOTION. WARRANTIES

FREEMOTION®

PHONE +1 877-363-8449 || **EMAIL** sales@freemotionfitness.com || **WEBSITE** freemotionfitness.com