

尺寸：210*140mm

骑马钉

整本用128g铜版纸

TAOTRONICS

Questions or Concerns?

support@taotroincs.com



TAOTRONICS STAND FAN

TT-TF009

User Manual

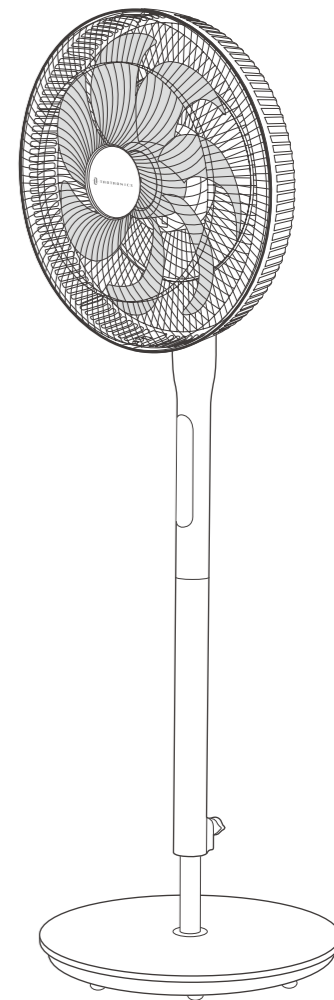

1

01-02

IMPORTANT
SAFETY
INSTRUCTIONS

2

03-03

IN THE BOX

3

04-05

ASSEMBLING
YOUR FAN

4

06-10

USING YOUR FAN

5

11-11

CLEANING AND
MAINTENANCE

6

12-12

TROUBLESHOOTING

7

13-13

WARRANTY AND
SERVICE



THANK YOU

FOR BEING OUR CUSTOMER



Your purchase is truly appreciated!
We hope you are over-the-moon with our product!

IMPORTANT SAFETY INSTRUCTIONS



BEFORE USING THIS APPLIANCE READ ALL INSTRUCTIONS AND CAUTIONARY MARKINGS IN YOUR USER MANUAL AND ON THE APPLIANCE



DO NOT touch or hold the mains plug with wet hands.



DO NOT block or cover air flow to or from the Fan while in operation.



DO NOT insert fingers or objects through the grille while in operation.

INTENDED USE

- This appliance is not intended for use by persons (including children) with reduced physical, sensory or mental capabilities, or lack of experience and knowledge, unless they have been given supervision or instruction concerning the use of the appliance by person responsible for their safety.
- Close supervision is necessary when any appliance is used by or near children. Children should be supervised to ensure that they do not play with the appliance. Cleaning and user maintenance shall not be done by children unless they are older than 8 and supervised.
- Use the appliance only for intended household purposes as described in this User Manual. Any other use is not recommended that may cause fire, electric shock, or injury to persons.

ELECTRICITY SAFETY

- This appliance must be provided with correct voltage via a professionally installed power socket. Make sure the voltage indicated on the label of the appliance is the same as your local supply.
- DO NOT operate the fan with a damaged cord or plug or if the product malfunctions, is dropped or damaged in any manner.
- To reduce the risk of fire or electric shock, DO NOT use this fan with any solid-state speed control device.
- **IMPORTANT** - This appliance has a polarized plug (one blade is wider than the other). To reduce the risk of electric shock, this plug is intended to fit in a polarized outlet only one way. If the plug does not fit fully in the outlet, reverse the plug. If it still does not fit, contact a qualified electrician. Do not attempt to rig this safety feature.
- This product employs overload protection (fuse). A blown fuse indicates an overload or short-circuit situation. If the fuse blows, unplug the product from the outlet. Replace the fuse according to the instructions in this manual (follow product marking for proper fuse rating) and check the product. If the replacement fuse blows, a short-circuit may be present and the

product should be discarded or returned to an authorized service facility for examination and/or repair.

- DO NOT operate any fan with a damaged cord or plug.
- DO NOT run cord under carpeting. DO NOT cover cord with throw rugs, runners, or similar coverings. DO NOT route cord under furniture or appliances. Arrange cord away from traffic area and where it will not be tripped over. DO NOT operate any fan with a damaged cord or plug.

RELATED TO USE

- Avoid contacting moving parts. Wait until all parts have completely stopped before touching them.
- DO NOT use in a bathroom.
- Never use the product without the safety guard or with a damaged safety guard.
- DO NOT place any clothes or curtains on the product as they could be sucked into the fan during operation and damage the product.
- During use, keep hands, hair, clothing and utensils away from the safety guard to avoid injuries and damage of the product.
- DO NOT attempt to disassemble, repair, modify or replace any part any part of your product. All servicing should be performed by qualified personnel only.
- Always make sure to place the Fan on a flat, level surface before operation.
- Keep the cord out of heavy traffic areas and where it will not be tripped over. To avoid fire hazard, NEVER route cord under furniture or appliances.
- Always unplug the appliance before cleaning, making any repairs or servicing, or whenever not in use.
- It is normal that there is noise during operation. If too loud, please set the fan to lower speed.

FOR HOUSEHOLD USE ONLY

READ AND SAVE THESE INSTRUCTIONS

| | | |
|----------------|------------------------|----------------|
| Specifications | Power | 19W |
| | Input | 120V ~ 50/60Hz |
| | Remote Control Battery | CR2025, 3V |

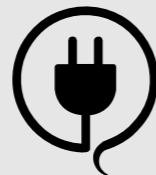

Regular Check

Have your Stand Fan checked regularly for any sign of malfunction!

Check if

- Plug, cord or appliance is damaged.
 - Excessive noise, unpleasant odor or abnormal heat.
- Stop using, check FAQ and contact TaoTronics Support Team.

In The Box

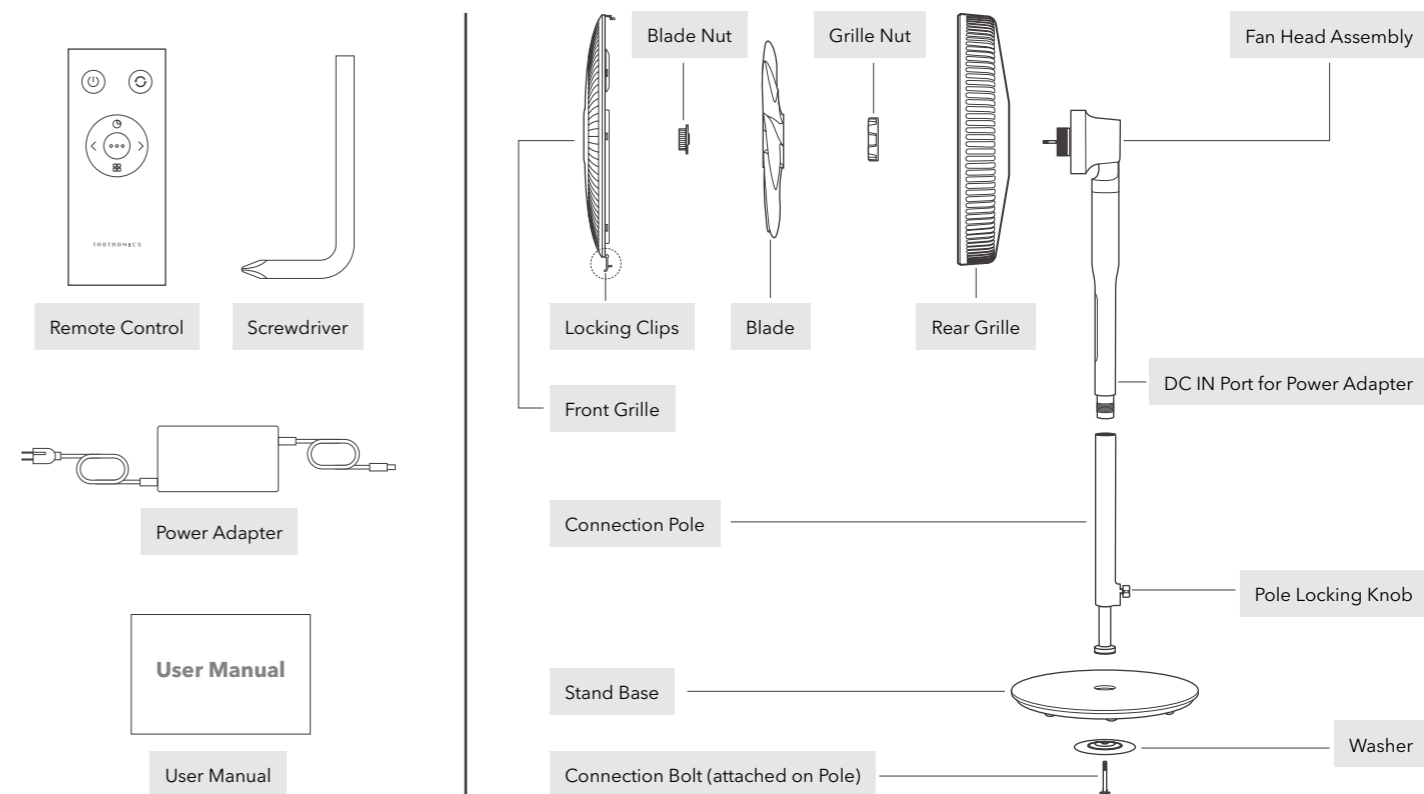

Assembling Your Fan

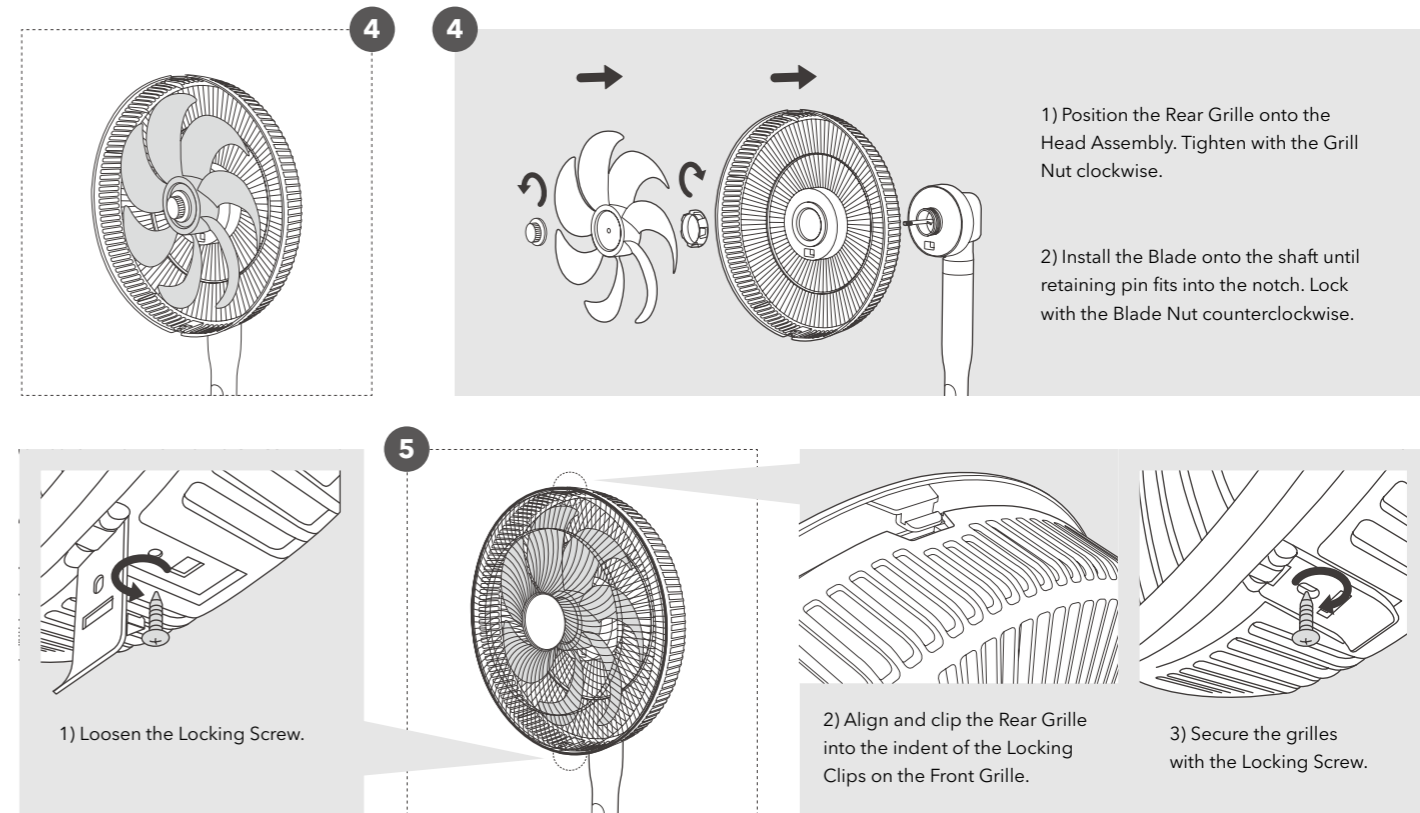
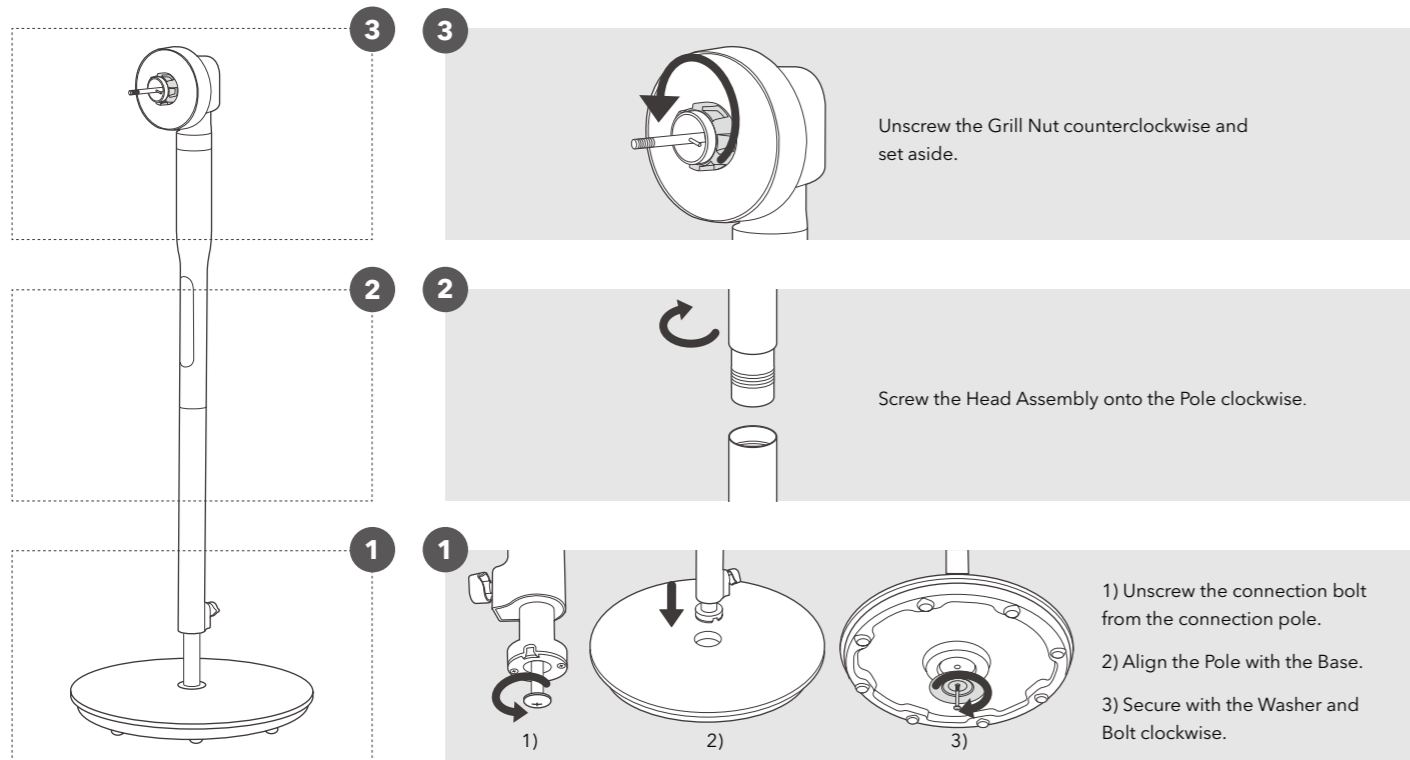

Using Your Fan

LED Display



Fan Speed 1-9
Timer 0-8h
Oscillation Angle — = ≡
Turbo Mode: H
Standby Mode: 0



Turbo Mode
Fan runs at maximum speed.



Sleep Mode
3 levels adjustable



Auto ON/OFF Timer
(0-8h) can be set on Remote Control.



Smart Airflow
Intelligently adjusts the fan mode based on the ambient temperature.

Operation and Functions



Power ON/OFF
Turn on/Standby mode



Turbo/Smart Airflow

- Turbo: Short press to turn on/off turbo (maximum) fan speed.
- Smart Airflow: Hold to turn on/off Smart Airflow.



Fan Speed/Mode

- Fan Speed: Short press to adjust speed.
- Mode: Hold to cycle through modes Normal-Turbo-Sleep.



Oscillation
Press repeatedly to cycle through oscillation angle
(60°) — >Stop > (90°) = >Stop > (120°) ≡ >Stop.

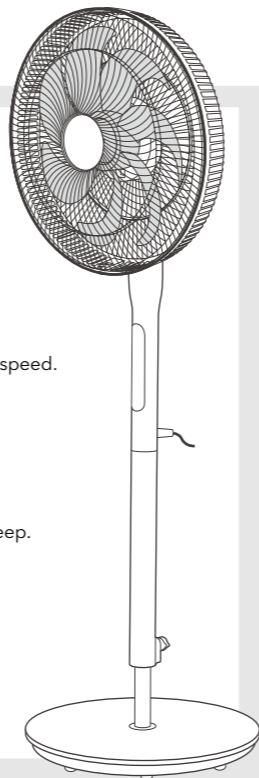

Using with Remote Control

Note:

For added convenience, the same control buttons can be found on the remote control.

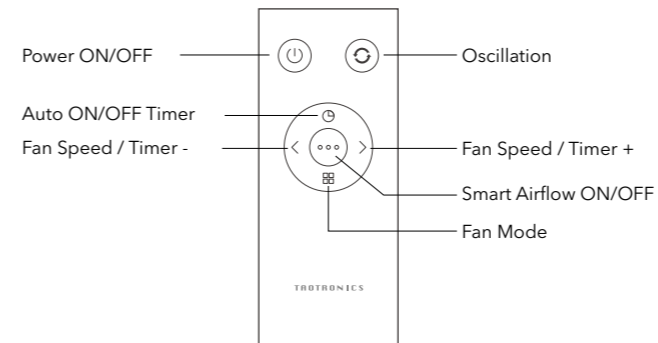

Memory Function

If power is not disconnected, it will always remember your last settings (except timer setting) once you turn it on again.

Auto Display OFF

- If no operation is done within 1 minute when powered on, the display will turn off automatically.
- To turn the display back on, press any button to wake it up.

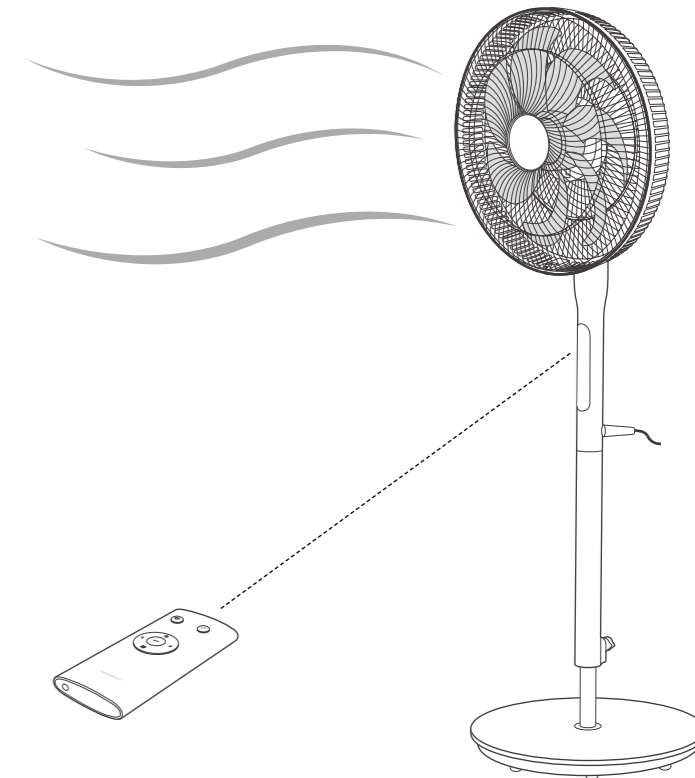

Replacement of Battery

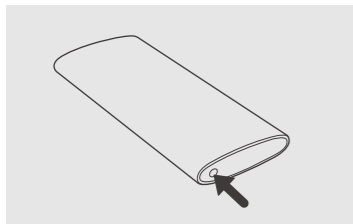

1. Press the locking button to remove the battery holder.

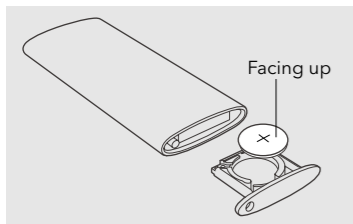

2. Replace the battery with the same type (CR2025, 3V), making sure the (+) side facing up.

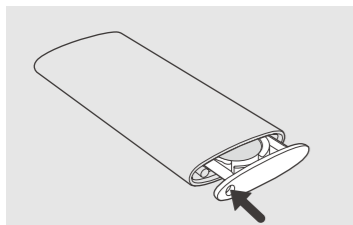

3. Push in the holder until securely locked into place.

CAUTION:

- Replace with new batteries of the same type when replacement is required.
- When not using the remote control for a long time, please take out the batteries.
- DO NOT attempt to dismantle the batteries.
- DO NOT dispose the batteries in fire, batteries may explode or leak.
- DO NOT use rechargeable batteries.

⚠ WARNING: Chemical Burn Hazard. Keep batteries away from children.

This product contains a lithium button/coin cell battery. If a new or used lithium button/coin cell battery is swallowed or enters the body, it can cause severe internal burns and can lead to death in as little as 2 hours. Always completely secure the battery compartment. If the battery compartment does not close securely, stop using the product, remove the batteries, and keep it away from children. If you think batteries might have been swallowed or placed inside any part of the body, seek immediate medical attention. The cells shall be disposed of properly, including keeping them away from children. Even used cells may cause injury.

Height/Angle Adjustment

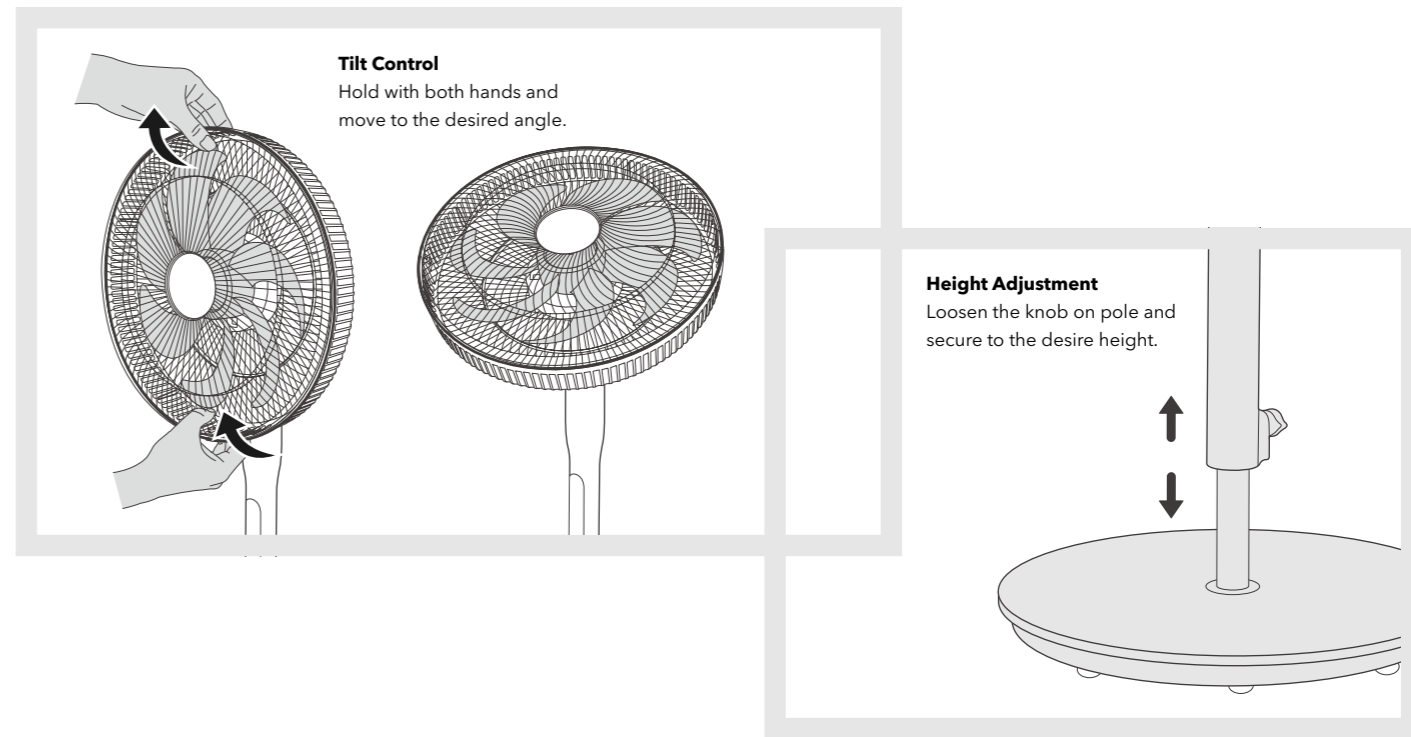

Fuse Replacement



This fan features a fused safety plug which is designed to cut off electric current to the fan if an electrical fault occurs. If your fan loses power and you suspect that the fuse on your fan has blown,

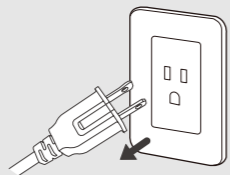

1. Grasp plug and remove from the receptacle or other outlet devices. Do not unplug by pulling on cord.

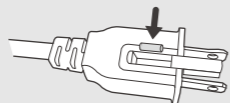

3. Remove fuse carefully. Insert the tip of your tool into fuse slot (close with the terminal), then prize the fuse gradually and slowly, but not overexert. If you feel tight, you can try it at several times and prize the fuse little by little. When one side of the fuse has been prized, then you can get the fuse out entirely. Risk of fire. Replace fuse only with 2.5 Amp, 125 Volt fuse.

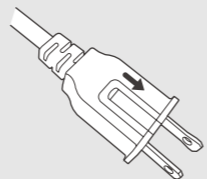

2. Open fuse cover. Slide open fuse access cover on top of attachment plug towards blades.

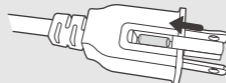

4. Close fuse cover. Slide closed the fuse access cover on top of attachment plug. Risk of fire. Do not replace attachment plug. Contains a safety device (fuse) that should not be removed. Discard product if the attachment plug is damaged.

Cleaning and Maintenance



Always make sure the Stand Fan is turned off and unplugged before cleaning.

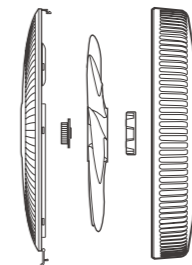

Washable Parts



1. Clean with a soft cloth or sponge dipped in diluted neutral detergent and rinse thoroughly.
2. Completely dry before reconnecting to a power source.

Do Not Wash



1. Wipe with a soft, dry cloth. If necessary, wipe with a damp cloth.
2. Completely dry before reconnecting to a power source.

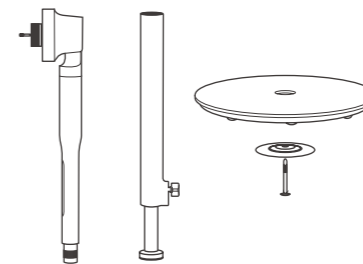

- DO NOT stick any foreign objects or your fingers inside of the unit.
- Never immerse in water or allow water to drip into the motor housing.
- DO NOT clean with abrasive chemicals or flammable cleaning agents.

Troubleshooting

The following troubleshooting guide addresses the most common problems. If problems persist, feel free to contact our Customer Support at support@taotronics.com.

FAQ1

Excessive noise.

- It is normal that there is noise during operation. If too loud, please set the fan to lower speed.
- Check if the blades are installed properly.

FAQ2

Fan vibrates.

- Make sure the fan is connected to a powered electrical outlet.
- If your fan loses power and you suspect that the fuse on your fan has blown, replace the fuse in the plug as instructed.

FAQ3

Fan does not operate.

- Make sure the fan is placed on a level surface.
- Clean the blades regularly.

Warranty and Service

Thanks for choosing TaoTronics Stand Fan. This product is covered with TaoTronics product and labor warranty for 12 months from the date of its original purchase.

The warranty will not apply in cases of:

- Accident, misuse, or repairs performed by unauthorized personnel.
- Any unit that has been tampered with or used for commercial purpose.
- Normal wear and tear of wearable parts.
- Use of force, damage caused by external influences.
- Damage caused by non-observance of the User Manual, e.g. connection to an unsuitable mains supply or non-compliance with the instructions.
- Partially or completely dismantled appliances.
- Defects caused by or resulting from damages from shipping or from repairs, service, or alteration to the product or any of its parts that have been performed by a repair person not authorized by TaoTronics.

We can only provide after sales service for products that are sold by TaoTronics or TaoTronics authorized retailers and distributors. If you have purchased your unit from a different place, please contact your seller for return and warranty issues.

* Please have your invoice and order ID ready before contacting Customer Support.

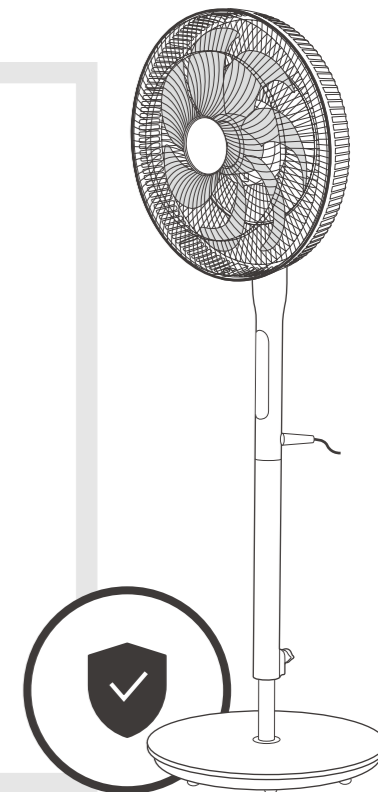



support@taotronics.com



www.taotronics.com



Manufacturer: Shenzhen NearbyExpress Technology
Development Co.,Ltd.
Address: Floor 7, Building E, Galaxy World Phase II,
Shenzhen, China



LISTED
E219869

Made in China Rev_1.4_EN