

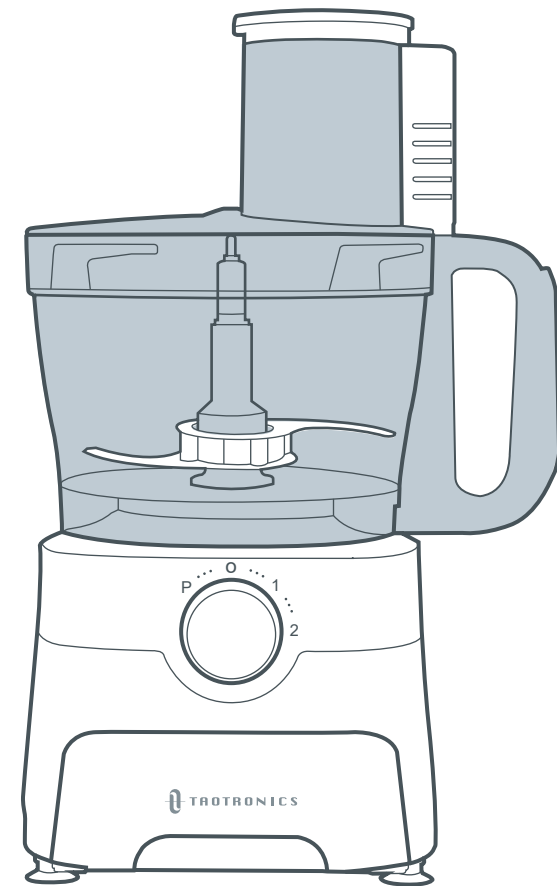

TAOTRONICS FOOD PROCESSOR

TAOTRONICS



Questions or Concerns?
support@taotronics.com

User Manual

THANK YOU

FOR BEING OUR CUSTOMER



Your purchase is truly appreciated!
We hope you are over-the-moon with our product!

CONTENTS

IMPORTANT SAFETY INSTRUCTIONS	02
KNOWING YOUR FOOD PROCESSOR	04
USING YOUR FOOD PROCESSOR	09
CLEANING AND STORAGE	14
TROUBLESHOOTING	16

01

IMPORTANT SAFETY INSTRUCTIONS

Requisite
Workhorse in
Your Kitchen



THE CUTTING TOOLS HAVE VERY SHARP EDGES.

DO NOT IMMERSE THE HOUSING BASE IN WATER.

SAVE THESE INSTRUCTIONS FOR HOUSEHOLD USE ONLY

- Please read this manual carefully before using this product.
- Do not allow children and persons with intellectual disabilities to touch or use this product.
- Please use this product on a dry and level surface. Do not place it on or close to a hot stove or touch any hot surfaces. Place the product carefully, any impact may cause damage.
- Do not hang the power cord on sharp objects, connect to movable objects, touch any hot surfaces, or make knots.
- Do not immerse the power cord, plug or the housing base in water or other liquids to prevent electric leakage.
- If the cord, plug or the product is damaged, stop using it immediately and return the product to the manufacturer for servicing.
- Do not use accessories other than this product, otherwise it may cause fire, electric shock, or injury.
- Before using, make sure that all components have been properly assembled and the product can be used under the local voltage.
- When using the processing bowl or the blender jar, do not open the lid, and do not put your fingers or any hard objects inside. It is strictly forbidden to press the food into the feeding opening directly with hands. Always use a pusher to avoid injuries.
- Never operate the processing bowl or the blender jar with no-load, overload, or overtime working.
- Always unplug the product from the outlet when it is not in use, or disassembling and cleaning accessories. Do not pull the cord.
- The accessories should be cleaned in time after use. The edges of all cutting tools are very sharp. Be careful during cleaning and assembly to avoid injuries.
- Please wait until all parts stop running before removing the lid of the processing bowl or the blender jar.

IMPORTANT - This appliance has a polarized plug (one blade is wider than the other). To reduce the risk of electric shock, this plug is intended to fit in a polarized outlet only one way. If the plug does not fit fully in the outlet, reverse the plug. If it still does not fit, contact a qualified electrician. Do not attempt to rig this safety feature.

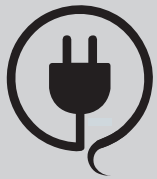

Regular Check

HAVE YOUR FOOD PROCESSOR CHECKED REGULARLY FOR ANY SIGN OF MALFUNCTION!

Check if plug, cord or appliance is damaged

Stop using, check FAQ and contact TaoTronics Support Team.

02

KNOWING YOUR FOOD PROCESSOR

Requisite
Workhorse in
Your Kitchen

Product Diagram

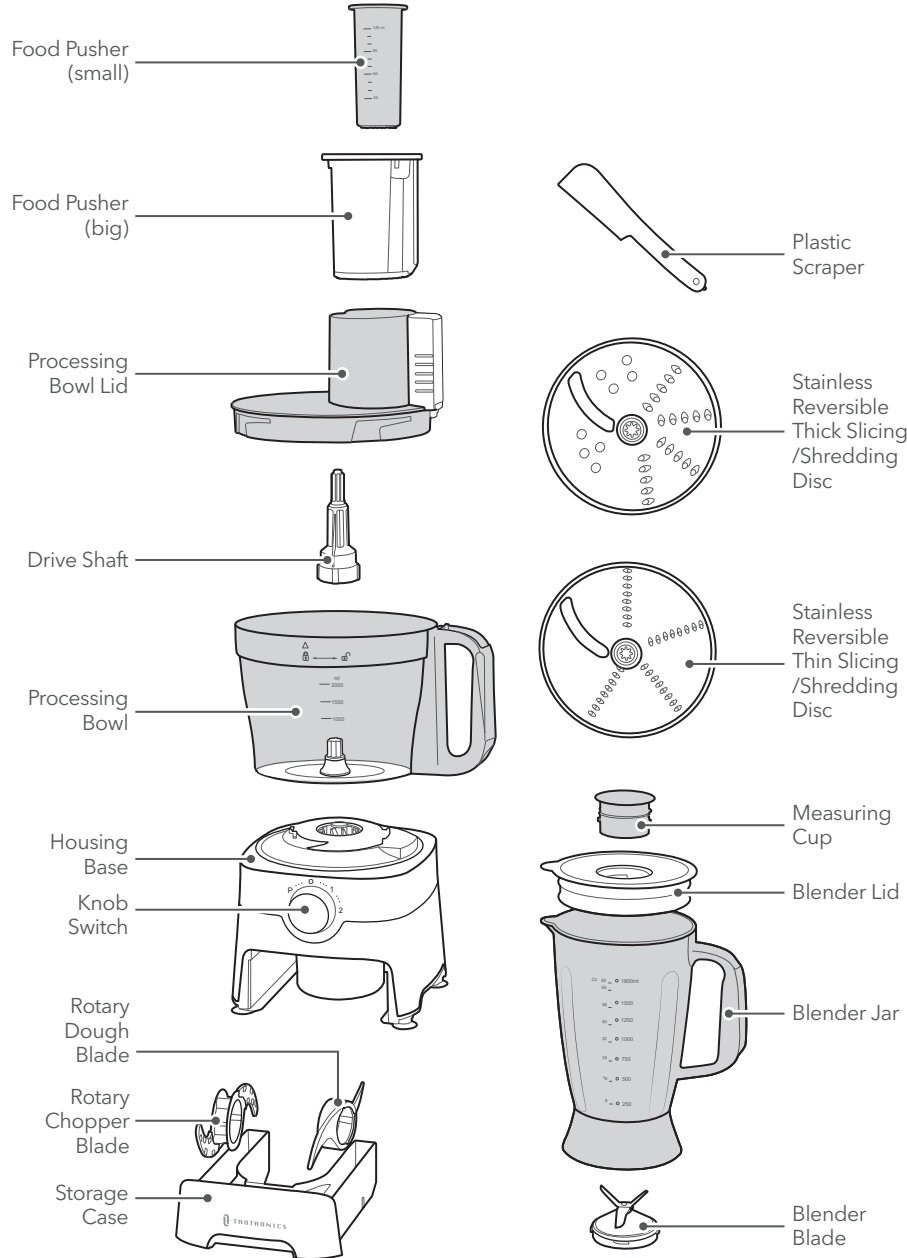

Knob Positions

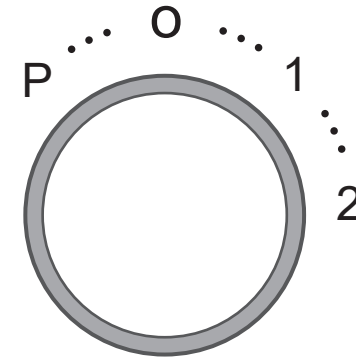

P	Pulse. Jog it but do not hold it for too long.
0	OFF. Turn off the motor.
1	Slow. The motor runs in low speed.
2	Fast. The motor runs in high speed.

Specifications

Power Supply	120V~60Hz
Rated Power	600W
Blender Jar Capacity	1800ml
Processing Bowl Capacity	2000ml

Recommended Accessory Selection

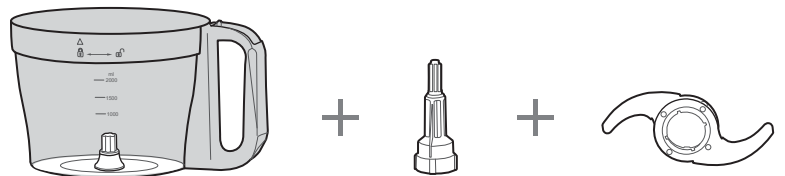

Processing Bowl + **Drive Shaft** + **Rotary Chopper Blade**

1 **CHOP**
Cheese / Chocolate / Fruit /
Fresh herb / Nuts / Tofu / Vegetables

P **MINCE OR PUREE**

1 **MIX**
Pasta Sauce / Pesto /
Salsa / Sauces

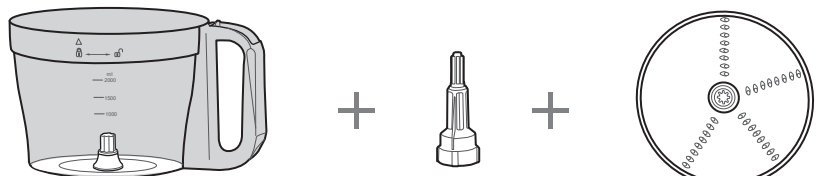

Processing Bowl + **Drive Shaft** + **Shredding side**

1 **SHRED**
Potatoes / Vegetables (soft)

2 **SHRED**
Cabbage / Cheese / Chocolate /
Fruit (hard) / Vegetables (hard)

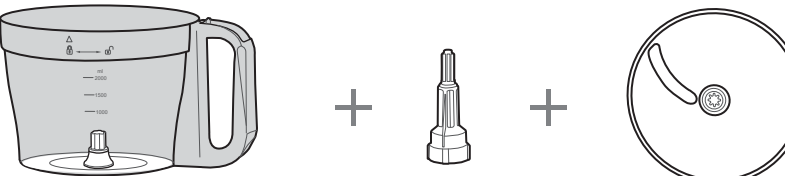

Processing Bowl + **Drive Shaft** + **Slicing side**

1 **SLICE**
Fruit (soft) / Potatoes / Tomatoes /
Vegetables (soft)

2 **SLICE**
Cheese / Chocolate / Fruit (hard) /
Vegetables (hard)

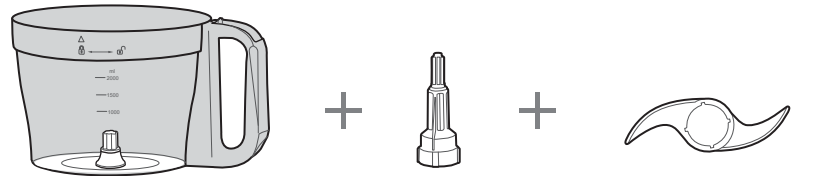

Processing Bowl + **Drive Shaft** + **Rotary Dough Blade**

P **KNEAD**
Batter / Sweet dough / Yeast dough

03

USING YOUR FOOD PROCESSOR

Requisite
Workhorse in
Your Kitchen

Processing with the Bowl

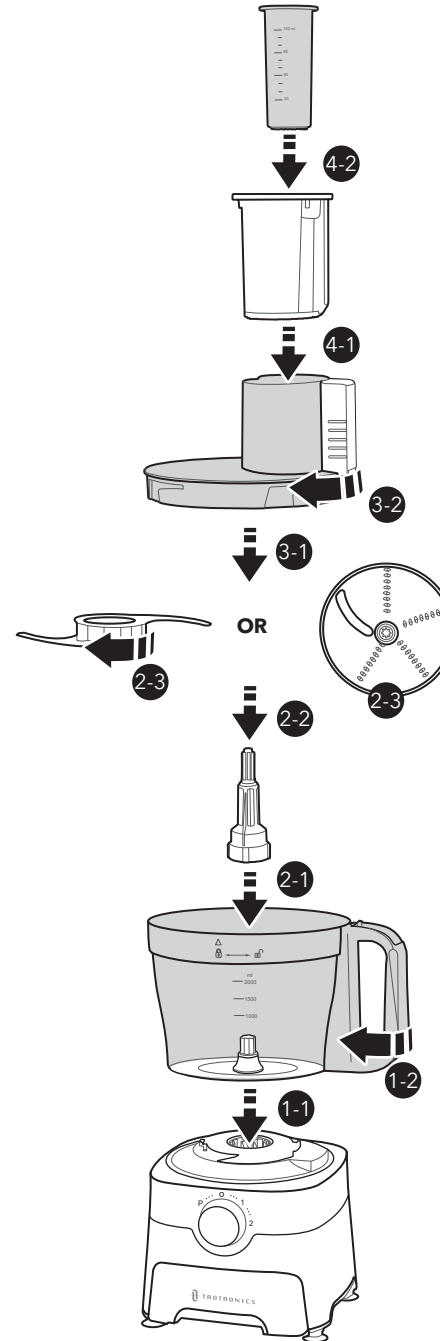

- 1 Put the processing bowl on the housing base, keep its handle to the right, and turn clockwise to lock.
- 2 Put the drive shaft in the center of the processing bowl. Put the slicing/shredding discs or the rotary blades onto the shaft.
- 3 Put on the processing bowl lid and turn clockwise to lock securely.
- 4 Push the big food pusher into the lid. Put the ingredients through the feeding opening.
- 5 Plug into an electrical outlet. Select a proper processing speed with the knob switch to start processing.

- Always turn the switch to "O" position during assembly. Plug into a socket and use pulse function to confirm whether the machine is assembled well. If there is anything abnormal, unplug the appliance and re-assemble it as above.
- Make sure the accessories are locked up in place, or the processor will not work to prevent accidental injuries.
- The rotary blades are stored in the storage case. During assembly, keep the blade side with "UP" upwards and turn to lock to the shaft.
- The discs are reversible for cutting different shapes of ingredients.

Bowl Accessories Instructions

Chopper Blade

Standard processing time	30-60s	
Volume per batch	Ingredient	Volume
	Chocolate	≤200g
	Cheese	≤350g
	Meat, Onion	≤800g
	Vegetable/Spice	100~150g
Fruit	300~500g	

Dough Blade

Standard processing time	20-30s	
Volume per batch	Ingredient	Volume
	Flour, Soft cheese	≤800g
	Egg	≤10 pcs

Tips:

- The ratio of flour to water while doughing is 5:3, means 100g flour need 60g water to make best effect.
- The standard of processing time is 30s, that's because the flour will become sticky and stick to the blade adapter if the time lasts too long. Then it will cause the machine shake and work abnormally.

Processing with the Blender

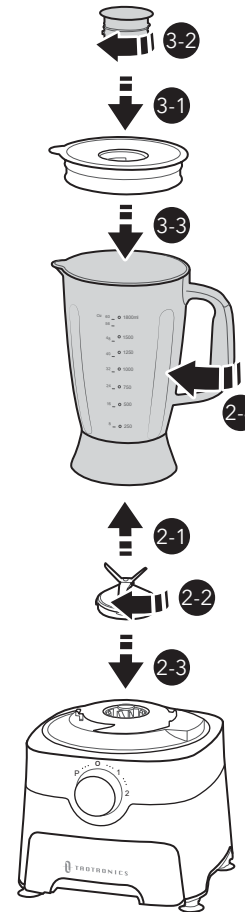

Regular recipe:

2/5 carrot, 3/5 water
(Max: 720g carrot, 1080g water)
Standard processing time: 60s.

- 1 Position the housing base on a flat and dry surface.
- 2 Put the blender blade into the bottom of the blender jar and turn anticlockwise to lock. Position the blender jar on the housing base, turn clockwise to lock.
- 3 Prepare the ingredients and put them in the blender jar. Put the measuring cup into the blender lid and turn clockwise to lock, close the blender lid well. (Max capacity: 1800ml)
- 4 Plug in and use pulse 2-3 times as pre-blending. Then choose a desired speed to start processing.

- Always turn the switch to "O" position during assembly.
- During operation, you can take out the measuring cup on the blender lid and add water or any other ingredients through the filling hole.
- Ingredients should not exceed half capacity. Make sure the blender blade fixed firmly, otherwise the ingredient may spillover during working.

Tips:

- Do not operate the appliance continuously for over 3 minutes. Operation for over 5 minutes may trigger the over-heat protection of the motor. Cool it down for 30 minutes and plug again before using again.
- During processing, select the disc or blade according to the hardness, shape etc. of the ingredients. Cutting into smaller shapes can make the process much faster and easier.
- Press ingredients gently with the proper food pusher to make ingredients more even. Do not push the ingredients violently with the pusher.
- If you need to process ingredients with the blender, add proper amount of water, otherwise the blade will not work normally.
- Select fast speed first, then slow down if the cutting effect is not ideal. Starting with low speed may cause locked-rotor and damage to the processor. Low speed is recommended while slicing soft ingredient to prevent it from pasty.

04

CLEANING AND STORAGE

Requisite
Workhorse in
Your Kitchen

Regular Cleaning



- Always unplug from outlet before cleaning to avoid electric shock.
- Use the plastic scraper to remove the debris on the inwall of the containers before cleaning.
- To prevent damage to the locking system, always store the processing bowl and the lid in the unlocked position when not in use.
- Store the blades in the storage case. Store the discs in a dry and vented location. Keep the discs and blades away from children.
- The blades and discs have very sharp edges. Be careful when disassemble them before cleaning.
- Use a brush while cleaning to avoid direct contact with the accessories.



All parts above are dishwasher safe. When cleaning the blender jar, add some warm water and detergents, put on the lid and jog the knob for several times. Take it off from the base and clean with tap water.

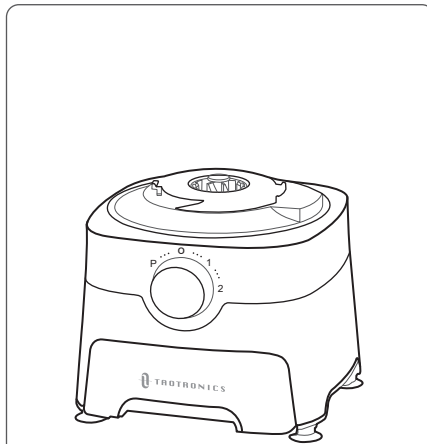

Wipe the housing base with a damp cloth, then dry with a soft cloth. Do not use abrasive cleansers. Do not immerse the housing base in water or drip water into the housing base.

05

TROUBLE-SHOOTING

Requisite
Workhorse in
Your Kitchen

Food Processing

The food is unevenly processed.

- Cut the ingredients evenly into pieces before processing.
- Process in batches to avoid overloading.

Slices are uneven or slanted.

- Place evenly cut food, cut side down, into the feeding opening.
- Apply even pressure on the pusher.

Some food remains on the disc.

It is normal for small pieces to remain; cut remaining bits manually and add to processed ingredients.

The processor shakes violently during working.

- Reduce ingredients in the bowl, or the processor may lose balance.
- Chop ingredients into smaller pieces before processing and put evenly in the bowl.
- Install the blades firmly as instructed to avoid shaking.
- Place the processor on a flat smooth surface. The sucker feet can keep the balance of the processor.

Dough Kneading

The motor slows down.

- Amount of dough may exceed maximum capacity. Remove some dough and process in batches.
- Dough may be too wet. If the motor speeds up, continue processing. If not, add more flour until the motor speeds up. Process until dough cleans the sides of the bowl.

The blade doesn't incorporate ingredients.

- Always start the food processor before adding liquid. Add liquid slowly through the feeding opening for letting the dry ingredients absorb it.
- If too much liquid is added, wait until ingredients in the bowl have mixed (do not turn off the machine).
- Do not pour liquid directly onto bottom of the processing bowl.

The blade rises in the processing bowl.

Excessively sticky dough may cause the blade to rise. Carefully reinsert the blade and immediately add some flour through the feeding opening while the machine is running.

Dough doesn't clean inside of the processing bowl.

- Amount of dough may exceed maximum capacity of your food processor. Remove half and process in two batches.
- Dough may be too dry or too wet. While machine is running, add water if it is too dry, add flour if it is too wet, until dough cleans the inside of the bowl.

Dough feels tough after kneading.

Divide dough into 2 or 3 pieces and redistribute evenly in the bowl. Process until the dough is uniformly soft and pliable.

Product Issues

The processor doesn't start.

- Ensure all accessories are properly assembled. NEVER try to install the bowl with handle on the left. There is a safety interlock to prevent the motor from starting if not properly assembled.
- If the processor still cannot start, check the power cord and outlet.

The processor shuts off during operation.

- The lid may have become unlocked; check to make sure it is securely in position.
- The processing bowl or the blender might loose during processing, reattach the bowl or the blender and start again.
- Long time operation may trigger the over-heat protection. We suggest you to use the machine 2 minutes per time (blender function for 1 minute per time). Cool it down before using again if over-heat protection is triggered.

Difficult to assemble the blade and the drive shaft.

Carefully install the blade over the drive shaft. Ensure that the UP marking is facing upwards when fitting the blade onto the drive shaft. Slightly rotate the blade to align with the grooves on the drive shaft. Once aligned, the blade will lower down, almost touching the bottom of the processing bowl.

The processor emits dark smoke or pungent smell.

This happens when the motor gets overheated, turn it off and unplug from the outlet. Wait for at least 30 minutes and plug again before using again.

Accessory is broken or missing.

Contact our Customer Support for guidance or replacement.

The troubleshooting guide addresses the most common problems. If problems persist, feel free to contact the Customer Support at

support@taotronics.com 

WARRANTY AND SERVICE

Thanks for choosing TaoTronics Food Processor.

This product is covered with TaoTronics product and labor warranty for 12 months from the date of its original purchase.

The warranty will not apply in cases of:

- Accident, misuse, or repairs performed by unauthorized personnel.
- Any unit that has been tampered with or used for commercial purpose.
- Normal wear and tear of wearable parts.
- Use of force, damage caused by external influences.
- Damage caused by non-observance of the User Manual, e.g. connection to an unsuitable mains supply or non-compliance with the instructions.
- Partially or completely dismantled appliances.
- Defects caused by or resulting from damages from shipping or from repairs, service, or alteration to the product or any of its parts that have been performed by a repair person not authorized by TaoTronics.

We can only provide after sales service for products that are sold by TaoTronics or TaoTronics authorized retailers and distributors. If you have purchased your unit from a different place, please contact your seller for return and warranty issues.

✳️ **Please have your invoice and order ID ready before contacting Customer Support.**

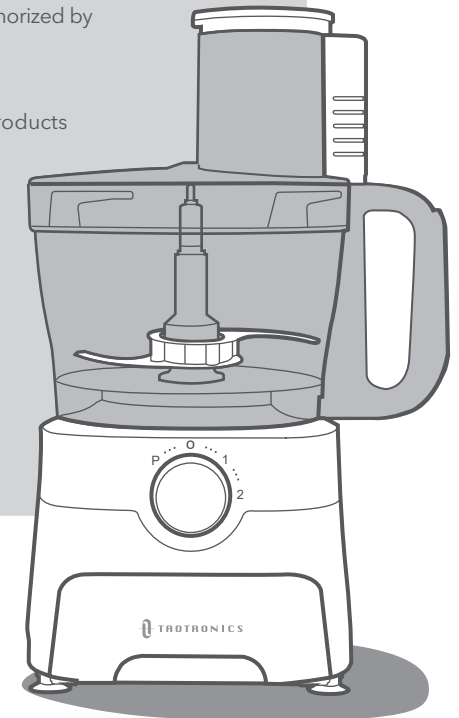

Model: TT-FP001



support@taotronics.com



www.taotronics.com



Manufacturer: Shenzhen NearbyExpress Technology Development Co.,Ltd.
Address: Floor 7, Building E, Galaxy World Phase II, Shenzhen, China



Intertek
3113264
Made In China

尺寸：140*210mm

装订成册

材质：封面128克铜版纸（四色印刷不覆膜）

内页80克日本白牛皮（单色印）