

尺寸：210\*148mm

骑马钉

封面128g铜版纸，内页80g书纸



[www.taotronics.com](http://www.taotronics.com)

**E-mail:**

[support@taotronics.com](mailto:support@taotronics.com)

**MANUFACTURER**

Manufacturer: Shenzhen NearbyExpress Technology Development Co.,Ltd.

Address: Floor 7, Building E, Galaxy World Phase II, Shenzhen, China



Made in China

Model: TT-CL025  
TaoTronics LED Stand Light  
**User Guide**

## **Contents**

<b>01</b>	<b>IMPORTANT SAFETY INSTRUCTIONS</b>
<b>03</b>	<b>Specifications</b>
<b>03</b>	<b>Features</b>
<b>04</b>	<b>Knowing Your Stand Light</b>
<b>06</b>	<b>Assembly</b>
<b>11</b>	<b>Using Your Stand Light</b>
<b>15</b>	<b>Wide Applications</b>
<b>16</b>	<b>Cleaning and Maintenance</b>
<b>16</b>	<b>Caution</b>
<b>17</b>	<b>Troubleshooting</b>
<b>18</b>	<b>Warranty</b>
<b>18</b>	<b>FCC Compliance</b>



Thank you for choosing the TaoTronics LED Stand Light. Please read this User Guide thoroughly before use and retain it for future reference.

## IMPORTANT SAFETY INSTRUCTIONS

**READ AND FOLLOW ALL SAFETY INFORMATION AND INSTRUCTIONS. KEEP FOR FUTURE REFERENCE.**

### **⚠ CAUTION**

To ensure correct and safe usage and functioning of the product, always follow these instructions carefully and keep for future reference.

Please keep the light away from water or any other liquid to avoid electrical shock.

Do not look directly into the light to avoid any injuries.

This appliance is not intended for use by persons (including children) with reduced physical, sensory or mental capabilities, or lack of experience and knowledge, unless they have been given supervision or instruction concerning the use of the appliance by person responsible for their safety.

Do not allow to be used as a toy. Close attention is necessary when used by or near children. Children should be supervised to ensure that they do not play with the product or remote shutter.

Do not operate any light with a damaged

cord or after malfunction occurs, or damaged in any manner. Discard the light, or return it to an authorized service facility for examination or repair.

Keep away from heat and avoid direct sunlight.

Do not try to repair or dismantle the light by yourself.

Keep the equipment out of reach of children or infants, avoid strangulation caused by the adapter cable.

Switch off the device when it is not in use.

Switch off the device before assembly and maintenance and disconnect from power supply by unplugging the USB power cord.

Do not operate the device with wet hands.

Follow local ordinances and recycling instructions regarding disposal or recycling of the device and device components.

If you have any product problems or report an unexpected situation during use, please

contact the Customer Support at **support@TaoTronics.com**.

THIS IS AN ELECTRIC LAMP - NOT A TOY!  
TO AVOID RISK OF FIRE, BURNS, PERSONAL

INJURY AND ELECTRIC SHOCK IT SHOULD NOT BE PLAYED WITH OR PLACED WHERE SMALL CHILDREN CAN REACH IT

## READ AND SAVE THESE INSTRUCTIONS

## Specifications

Model	TT-CL025
Ring Light Size	12 inch
Power	24W
Input	100-240V~50/60HZ
Output	24V = 1A
LED Qty	130
Lifespan	>20000 Hours
Tripod Stand Extendable Height	430-1990mm/17-78inch
Color Temperature	Cool White: 5800K-6500K Warm White: 4100-4700K Warm Yellow: 2700-3300K
Remote Battery	CR2032, 3V

## Features

Your new TaoTronics LED Stand Light is a perfect light source for portrait and beauty photography with many features and benefits:

- 3 Color Lighting Modes: Cool White, Warm White and Warm Yellow

- Stepless adjustment of color temperature and brightness

- Convenient remote control & controller

- Upgraded tripod stand for increased stability

- 24W power adapter for better lighting effect

- 360° rotation for any shooting angle without limitations

- Easy to assemble

## Knowing Your Stand Light

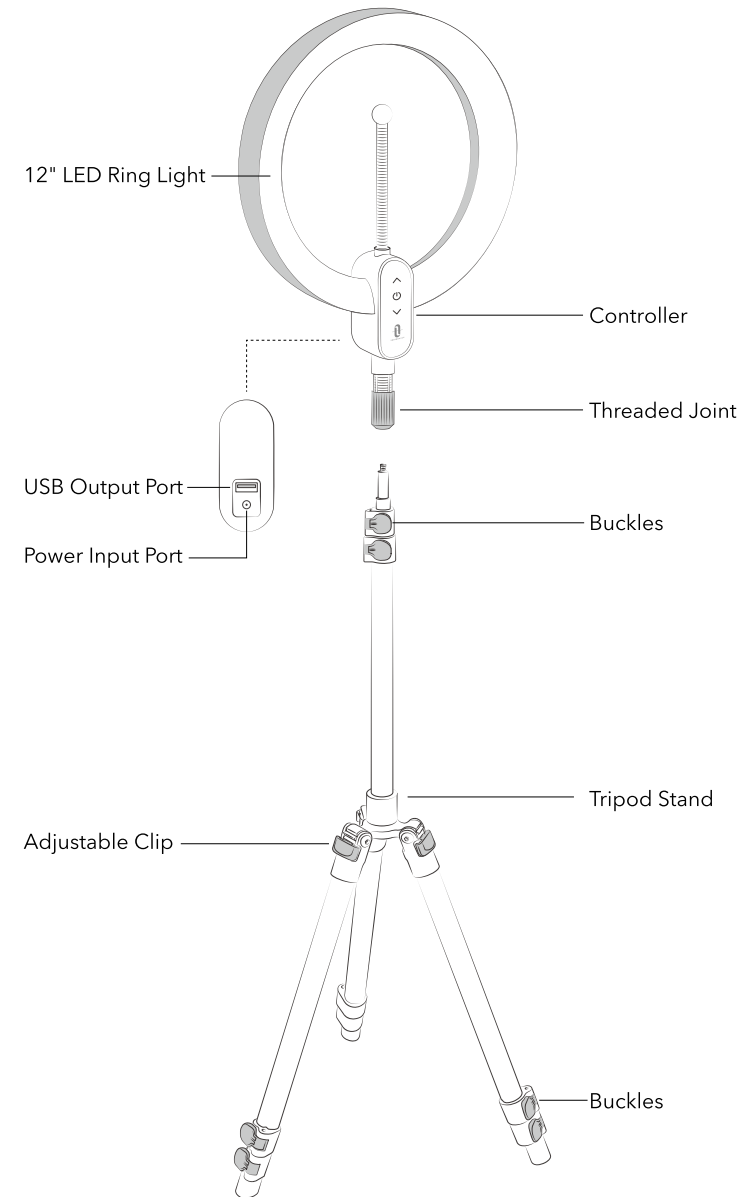

# Knowing Your Stand Light



Remote Control

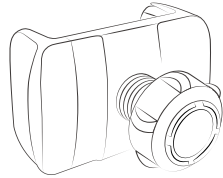

Tripod Mount Phone Holder

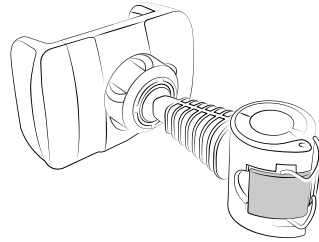

Flexible Phone Holder

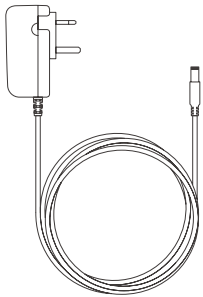

Power Adapter (UK)

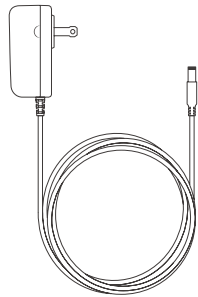

Power Adapter (US)

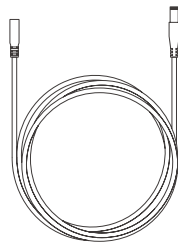

Extension Cord



User Guide



Thank You Card

# Assembly - Tripod Stand

1

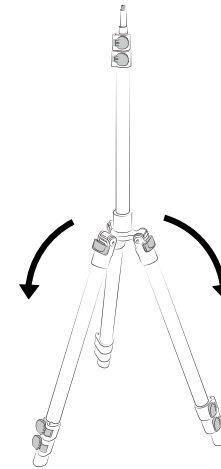

Unfold the tripod legs with the same angle. Adjust to the desired width.

2

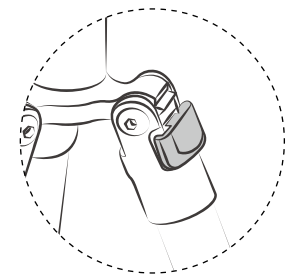
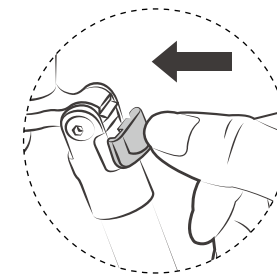
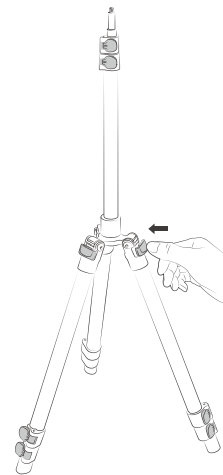

Lock the Adjustable Clip to its place.

## Assembly - Ring Light

1

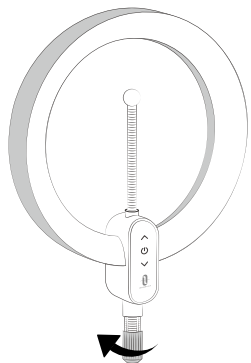

Unscrew the Threaded Joint.

2

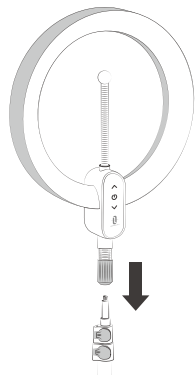

Fully insert the Ring Light.

3

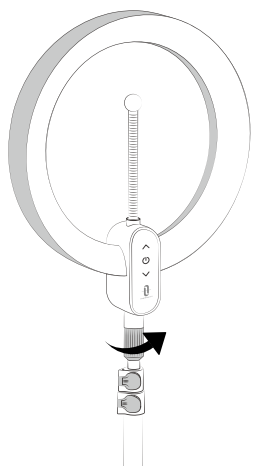

Screw tight.

4

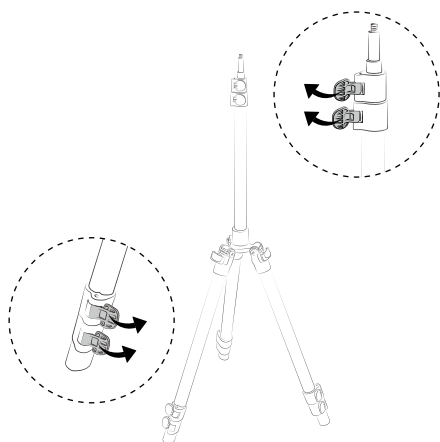

Loosen the buckles.

5

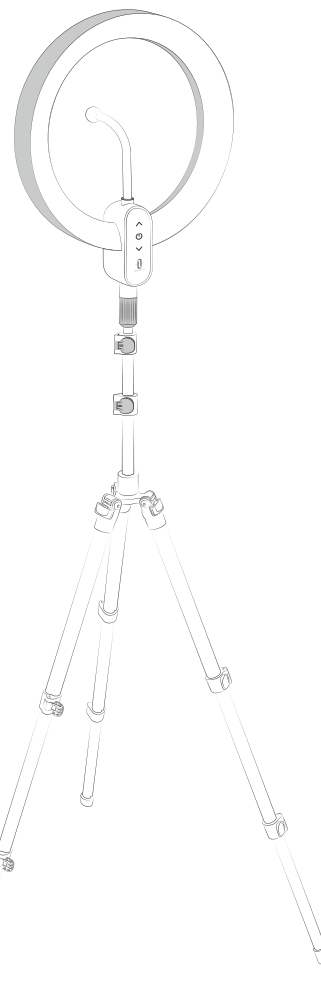

Adjust to desired height and lock.

6

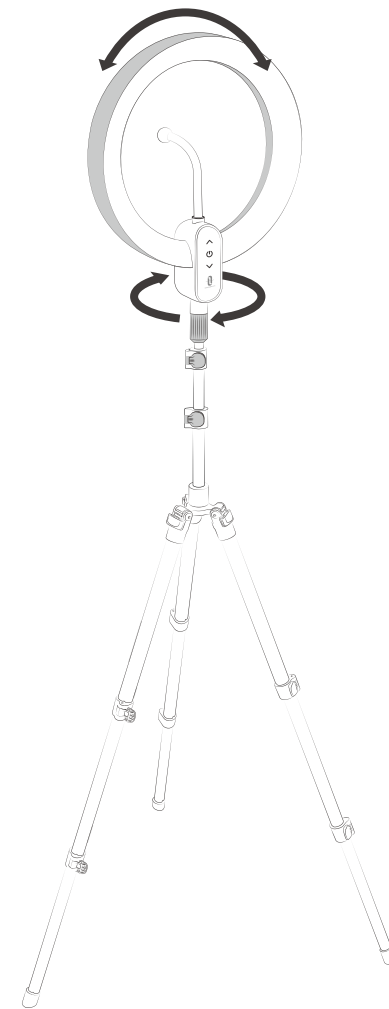

Adjust to desired angle.

## Assembly - Ring Light

## Assembly - Tripod Mount Phone Holder

1

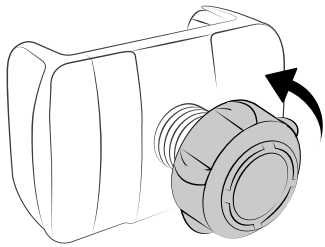

Loosen the Adjustable Knob.

2

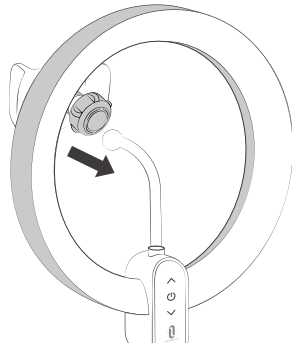

3

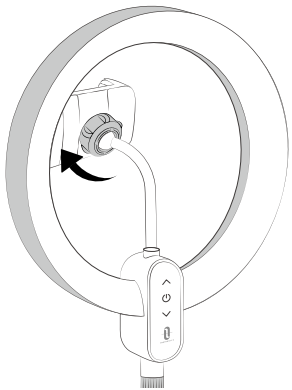

4

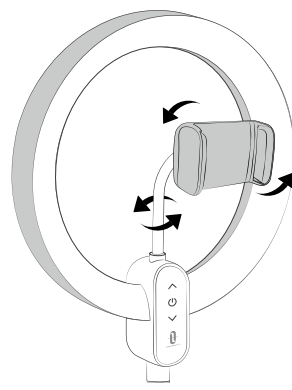

360° rotation.

## Assembly - Flexible Phone Holder

1

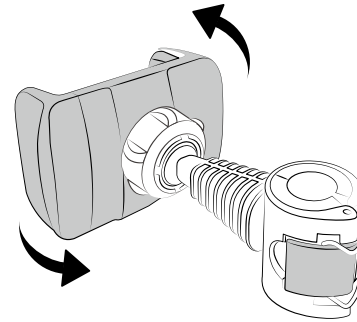

360° rotation.

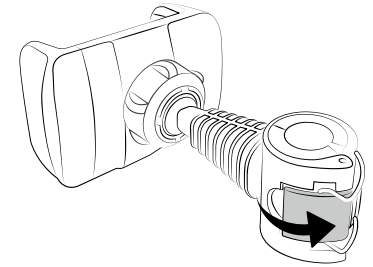

Open the clip.

2

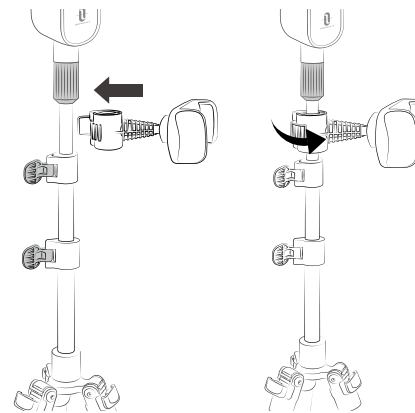

Install onto desired position and Lock to its place

⊗

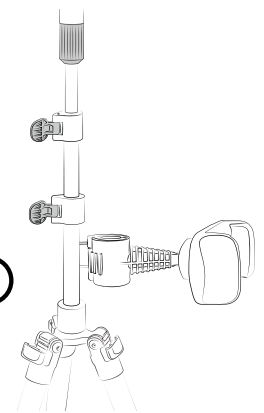



# Using Your Stand Light

## Getting Started

1

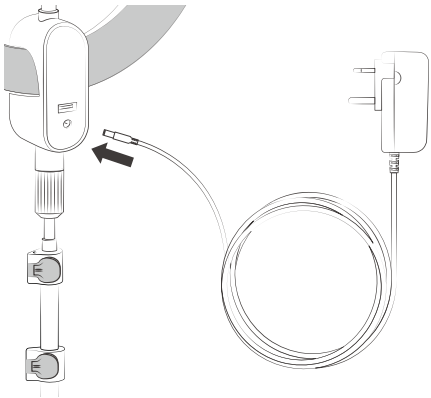

Connect to power adapter.

2

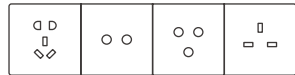

Plug into an appropriate electrical outlet.

3

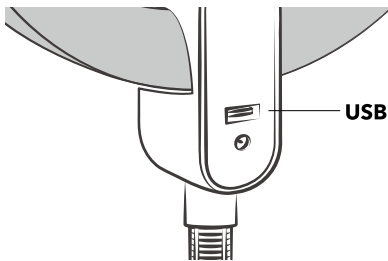

USB output port

(Optional) Connect to the USB output port to charge your device.

# Using Your Stand Light

## Controlling via Controller



**Power ON/OFF/Color Temperature Adjustment**

Press and hold to turn on/off.

With light on, repeatedly short press to cycle through 3 lighting modes.

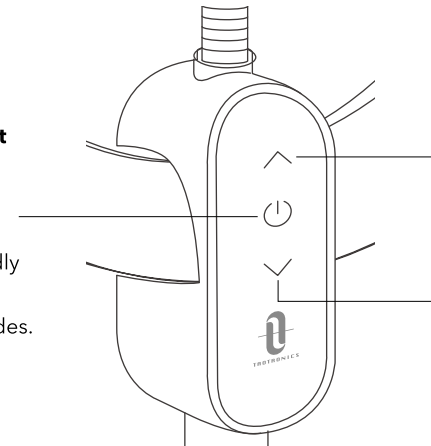

**Brightness +**

With light on, repeatedly short press to increase brightness (10 levels).



**Brightness -**

With light on, repeatedly short press to decrease brightness (10 levels).

# Using Your Stand Light

## Controlling via Remote

32.8ft / 10m Remote Distance

K- K+

### Color Temperature - / +

With light on, repeatedly short press to decrease / increase color temperature (5 levels).

With light on, press and hold to steplessly decrease / increase color temperature.

M

### Lighting Mode

With light on, repeatedly short press to cycle through 3 lighting modes.

^ v

### Brightness + / -

With light on, repeatedly short press to increase / decrease brightness (10 levels).



### Power ON/OFF

Press once to turn on/off.



### Camera

Short press to take photos.

### Bluetooth Pairing

Press and hold to pair with your Bluetooth device.

# Using Your Stand Light

## Pairing

1

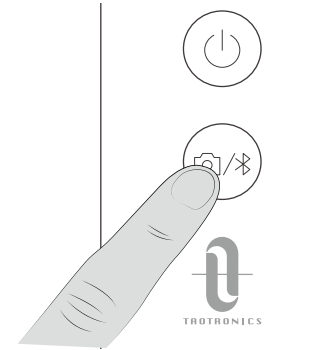

Press and hold until the remote indicator flashes blue, indicating the remote is waiting for pairing.

2

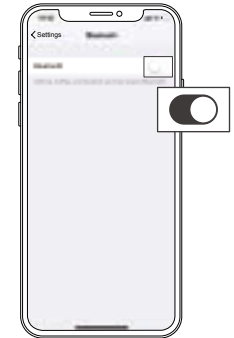

Enable Bluetooth function and search for nearby devices.

3



Search for "TAOTRONICS Selfie" and connect.

## Using Your Stand Light

### Take Photos

- 1 Turn on Camera on your phone.
- 2 Short press   to take photos.

## Wide Applications

1. Photography
2. Make Up
3. Live Stream
4. Selfie Stick
5. Video Recording
6. Extra Lighting

## Cleaning and Maintenance

Always unplug the USB power port before cleaning.

To avoid the risk of electric shock, do not clean the stand light or the power cord with water and do not immerse them.

Clean the stand light or tripod stand with a soft damp cloth on a regular basis.

When not in use for a long period of time, it is recommended to detach the stand light, then store the stand light and tripod stand in a cool, dry location.

## Caution

Do not disassemble the device without authorization.

Do not store the product in a high temperature environment.

To avoid any damage to the tripod stand, do not place excessive force on it.

When adjusting the tripod stand, make sure the clips and the buckles are unlocked. When using the tripod stand, make sure the clips and the buckles are locked.

## Troubleshooting

The following troubleshooting guide addresses the most common problems. If problems persist, contact the Customer Support at [support@TaoTronics.com](mailto:support@TaoTronics.com)

Problem	Possible Cause	Solution
The stand light does not light up	No power supply	Correctly connect to a powered electrical outlet.
	The stand light is not turned on	Refer to the Using Your Stand Light section.
The control panel is not responsive	Hands are wet	Tap the panel with dry hands.
	Voltage fluctuation	Disconnect the power adapter to restart the light.
LED failure	LED component failed	Please contact the TaoTronics Support Team.
The tripod stand is not stable	Not correctly installed	Make sure the clips and the buckles are locked to its place.

## Warranty

Thanks for choosing TaoTronics LED Stand Light. This product is covered with TaoTronics product and labor warranty for 12 months from the date of its original purchase. If any problems occur, please contact TaoTronics Customer Care Centre via the contact information listed in this User Guide.

The warranty will not apply in cases of:

Accident, misuse, or repairs performed by unauthorized personnel.

Any unit that has been tampered with or used for commercial purpose.

Normal wear and tear of wearable parts.

Use of force, damage caused by external influences.

Damage caused by non-observance of the User Guide, e.g. connection to an unsuitable mains supply or non-compliance with the instructions.

Partially or completely dismantled appliances.

Defects caused by or resulting from damages from shipping or from repairs, service, or alteration to the product or any of its parts that have been performed by a repair person not authorized by TaoTronics.

We can only provide after sales service for products that are sold by TaoTronics or TaoTronics authorized retailers and distributors. If you have purchased your unit from a different place, please contact your seller for return and warranty issues.

## FCC Compliance

This device complies with Part 15 of the FCC Rules. Operation is subject to the following two conditions:

(1) This device may not cause harmful interference, and

(2) This device must accept any interference received, including interference that may cause undesired operation.

