

Extend your warranty to 18 months by
registering your product on our website
taotronics.com/warranty.

support@taotronics.com

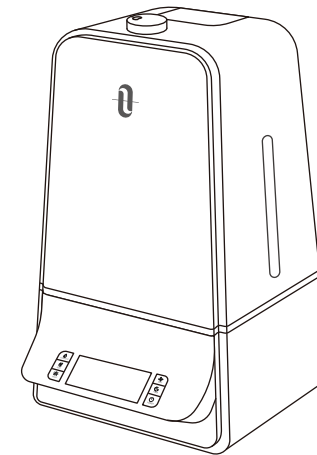

E-mail:
support@taotronics.com

MANUFACTURER

Manufacturer: Shenzhen NearbyExpress Technology Development Co.,Ltd.
Address: Floor 7, Building E, Galaxy World Phase II, Shenzhen, China

Learn more about the EU Declaration of Conformity:
<https://www.taotronics.com/pages/user-manual>

CONTENTS

STATEMENT	01
SAFETY INSTRUCTIONS	01
BEFORE USING THE HUMIDIFIER	02/03
WHEN USING THE HUMIDIFIER	04
AFTER USING THE HUMIDIFIER	05
PACKAGE CONTENTS	06
SPECIFICATIONS	06
PRODUCT DIAGRAM	07
OPERATIONS AND FUNCTIONS	08
Add water	08
Standby Mode	09
Power Button	09
Mist Adjustment	09
Timer Setting	09
Humidity Setting	09
Sleep Mode	10
Light Button (Night Light & Tank Light)	10
Low Water Protection	10
Memory Function	10
CLEANING AND MAINTENANCE	11
Caution	11
Daily Maintenance	11
Weekly Maintenance	11
Scale Removal Instructions	11
Disinfecting Instructions	13
Clean the Dustproof Sponge	13
End-Of-Season Care and Storage	13
TROUBLESHOOTING GUIDE	14/16
WARRANTY	17
TAOTRONICS CUSTOMER CARE	17

STATEMENT

Thank you for purchasing a TaoTronics product that has been tested to meet our stringent quality standards. This product is covered with TaoTronics product and labor warranty for **12** months from the date of its original purchase.

Please email us with your order ID and problem or issue via support@taotronics.com, we will respond within 24 hours.

Please read the User Guide thoroughly. Clean and maintain the product as instructed. If any abnormalities occur, please refer to the Troubleshooting Guide first.

This warranty is void if the defect is caused by accidental damage, misuse, abuse, neglect, improper repair or alteration by unauthorized persons, or a failure to follow operating instructions provided with the product including adding essential oils directly into the tank and base. This warranty does not apply to normal wear and tear or commercial use.

In no event shall liability exceed the purchase price paid by the purchaser of the product. Under no circumstances shall there be liability for any loss - direct, indirect or incidental - or consequential damage arising out of, or in connection with the use of the product.

SAFETY INSTRUCTIONS

The humidifier was made with safe and environmental protection materials, it has been certified and complied with the requirement of sale regions' related regulations or laws.

IMPORTANT: Please read and save this SAFETY INSTRUCTIONS before using the device. Basic precautions should always be followed to reduce the risk of fire, electrical shock, and injury to persons or damage to the product.

For indoor humidifying use only.

BEFORE USING THE HUMIDIFIER

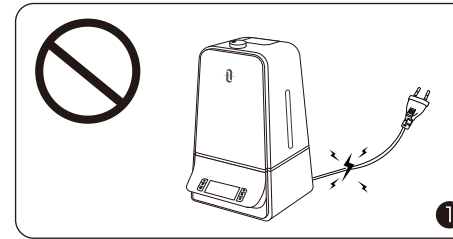

1. Please extend the cord and check any signs of damage. Do not use the humidifier if the cord has been damaged.



2. DO NOT place this humidifier in wet environments.

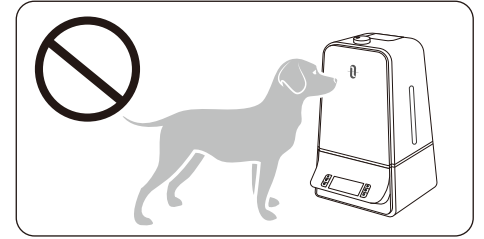
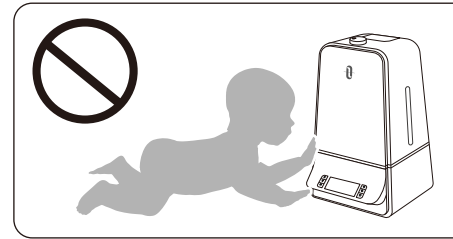

Please always keep the humidifier out of reach of patients & children & pet.

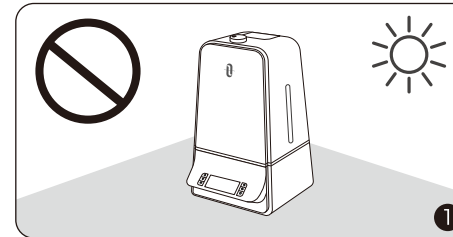

1. Please always place the unit on a smooth, flat, lint-free, non-metallic, waterproof and level surface and keep it away from direct sunlight.

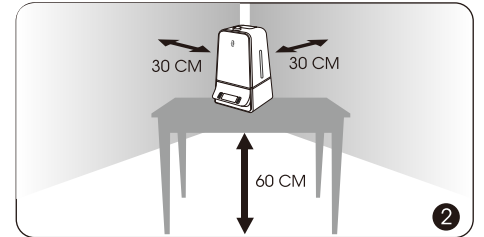

2. Always place the unit 2 feet (60 cm) above the floor, 12 inches (30 cm) away from the wall, other appliances or wooden furniture.



DO NOT place the humidifier near naked flames and heat sources, such as stove tops, ovens, radiators or computers.

WHEN USING THE HUMIDIFIER



1. DO NOT plug the unit with wet hands.

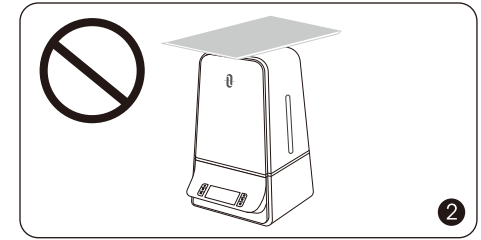

2. DO NOT use your hand or any other object to cover the nozzle while the unit is on to avoid damaging the product or causing injury.



1. DO NOT move or tilt the humidifier while it is in operation.



2. DO NOT clean the unit while it is connected to a power source or while it is on.

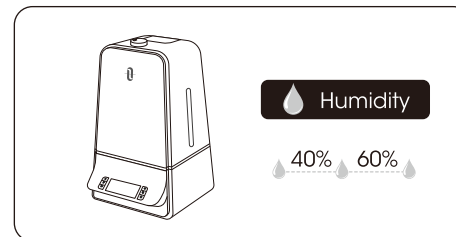

The most comfortable environmental humidity is between 40%-60%. Please adjust the mist as needed.

AFTER USING THE HUMIDIFIER

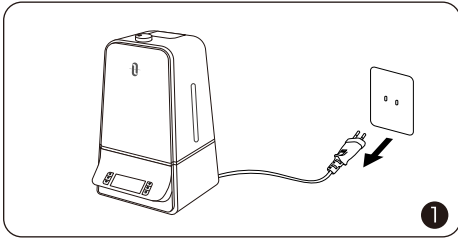

1. Always disconnect from a power source by pulling the plug when not in use.

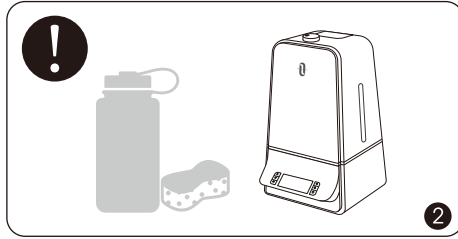

2. Humidifier requires regular cleaning. Please refer to, and follow the Cleaning and Maintenance instructions.

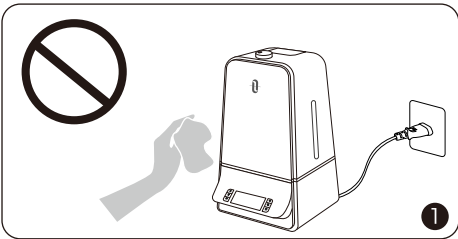

1. DO NOT clean the humidifier right after turning it off if the humidifier has been working for a long time. Allow the humidifier to completely cool down before cleaning.

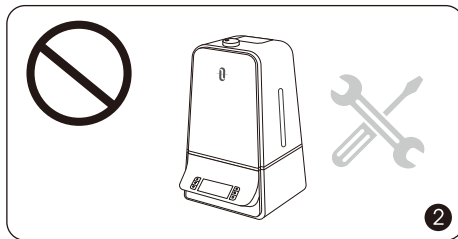

2. DO NOT attempt to repair or adjust any electrical or mechanical functions on this humidifier. Doing so will void your warranty.

PACKAGE CONTENTS

- 1 x TaoTronics Humidifier (Model: TT-AH044)
- 1 x Cleaning Brush
- 1 x Dustproof Sponge
- 1 x Thank You Card
- 1 x User Guide

SPECIFICATIONS

Model	TT-AH044
Operating Voltage	US/CA: 100-120V~ 50 / 60Hz
Rated Power	Max: 25W
Water Tank Capacity	6.0L / 1.59Gal
Mist Output	Min: 100ml/h Medium: 200ml/h Max: 300ml/h
Working Time on a Full Tank	20-60h
Recommended Room Size	20-40 m ² / 215-430 ft ²
Noise	≤27dB
Dimensions	251 x 167 x 412 mm / 9.9 x 6.6 x 16.2 in
Net Weight	1900g / 67.0oz

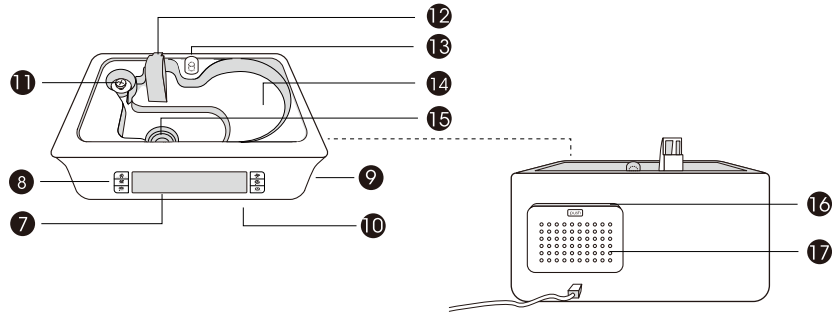
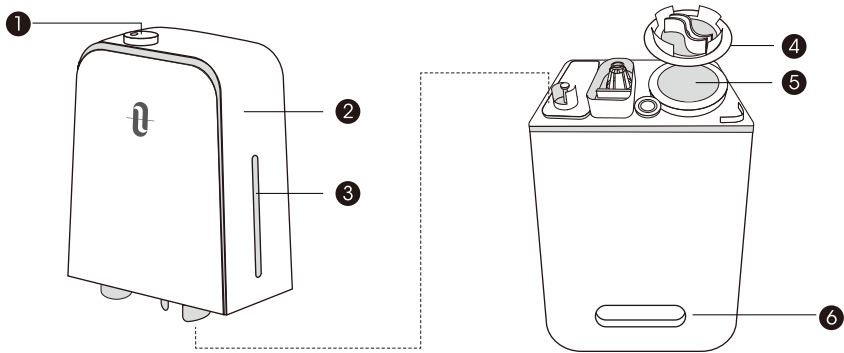

PRODUCT DIAGRAM

- | | |
|-----------------------|----------------------|
| 1. Nozzle | 10. Night Light |
| 2. Water Tank | 11. Floater |
| 3. Water Level Window | 12. Air Outlet |
| 4. Tank Cap | 13. Tank Light |
| 5. Water Inlet | 14. Water Reservoir |
| 6. Handle | 15. Atomizer |
| 7. LED Display | 16. Dustproof Sponge |
| 8. Control Buttons | 17. Air Inlet |
| 9. Base | |

OPERATIONS AND FUNCTIONS

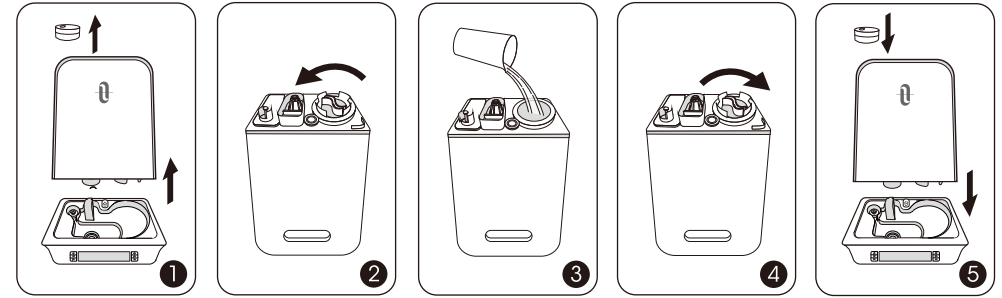

Add water

1. Remove the nozzle and turn the water tank upside down.
2. Remove the tank cap and fill the tank with clean and cool water only.
3. Attach the tank cap and place the tank back onto the base. Make sure it fits together securely so that water can go from the tank to the reservoir. Put the nozzle back on.

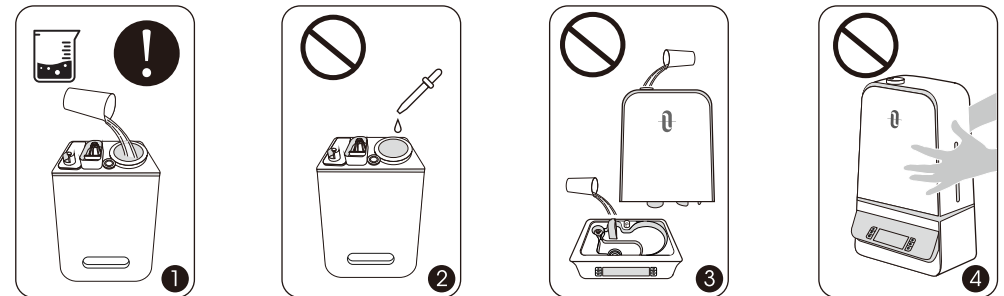

1. If tap water is too hard, it is recommended to use filtered or distilled water to avoid white dust. **DO NOT** use hot water.
2. **DO NOT** add any essential oils or medicinal tablets into the water tank.
3. **DO NOT** add water into the base or through nozzle.
4. **DO NOT** move the humidifier while the water tank is full of water to avoid leakage or base overflowing.

OPERATIONS AND FUNCTIONS

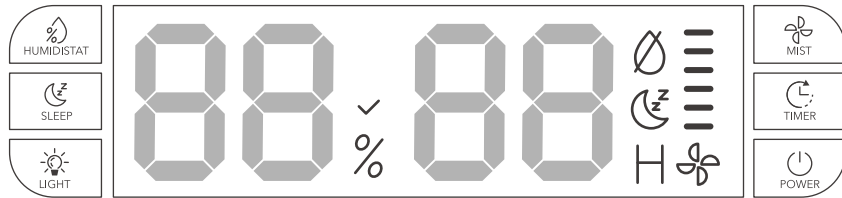

Standby Mode

- Connect the humidifier to a power source, the unit is in Standby mode now with the LED display showing the current humidity level.
- If no operation is done within 5 seconds under Standby mode, the LED display will turn off automatically.
- When there is not enough water inside the water reservoir, the humidifier will stop misting and Low Water Protection will be activated with  lighting up on the display.



POWER

Power Button

- Press the Power Button once to turn the humidifier ON with default settings: medium mist (200ml/h, 4 lines) & tank light on.
- Press it again to turn the humidifier OFF (mist off & tank light off). The fan will continue working for 3 minutes to dry the mist tube.



MIST

Mist Adjustment

- When the unit is on, press the Mist Button to cycle through Medium (4 lines) -> High (6 lines) -> Low (2 lines) mist levels.



TIMER

Timer Setting

- Press the Timer Button to set the timer from 01 to 12 hours by 1 hour increments, the timer will flash three times to confirm your setting.
- Once set, the LED display will show the countdown timer and the current humidity level. When time is up, the unit will automatically turn off.
- To cancel Timer setting, press and hold the Timer Button for 1.5 seconds or adjust the timer setting to 00.



HUMIDISTAT

Humidity Setting

- Press the Humidistat Button to set the humidity level from 30% to 95% in 5% increments, the set humidity level will flash three times to confirm your setting.

- When the preset humidity level is reached, the unit will stop misting with the white ✓ turning green.
- To cancel Humidity setting, press and hold the Humidistat Button for 1.5 seconds.

The most comfortable environmental humidity is between 40%-60%. Please adjust the mist as needed.



SLEEP

Sleep Mode

- When the mist is on, press the Sleep Button once to turn on the Sleep mode. All the indicators on the LED display will turn off except the Sleep indicator. If no operation is done within 3 seconds under Sleep mode, the sleep indicator will turn off automatically.
- Press any button (except the Light Button) to wake up Sleep Mode and LED display. All the other buttons remain functional. If no operation is done within 3 seconds, the LED display will turn off automatically.
- Press it again to exit Sleep mode. The sleep indicator will turn off and the LED display will remain on.
- When there is not enough water inside the water reservoir under Sleep Mode, the humidifier and the LED display will turn off automatically.
- When the Sleep mode is turned on under night light on, all the indicators on the LED display and the night light will turn off except the Sleep indicator. You can press the Light Button again to turn the night light on.



LIGHT

Light Button (Night Light & Tank Light)

- Night Light: Press the Light Button to turn on / off the night light (default: OFF).
- Tank Light: Press and hold the Light Button for 1.5 seconds to turn on / off the tank light (default: ON).
- The night light is separately controlled. You can turn on / off the night light when the unit is connected to power.



Low Water Protection

- When there is not enough water inside the water reservoir, the humidifier will stop misting and Low Water Protection will be activated with the icon lighting up on the display. It is designed for safety to prevent the humidifier from possibly overheating and damaging the atomizer.
- The humidifier cannot be started under low water status.

Memory Function

If power is not disconnected, the humidifier will always remember your last settings (mist level, humidity & night light) once you turn it on again.

CLEANING AND MAINTENANCE

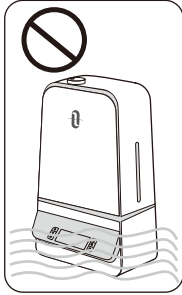

Caution

1. DO NOT submerge the base in water.
2. Make sure water does not enter the base through the air outlet, air inlet, or the control buttons and LED display.
3. DO NOT wash any part of this humidifier in dish washer which will damage the humidifier and void the warranty.

Daily Maintenance

Turn off the humidifier, unplug it from the power source. Drain water from the tank, reservoir and base.

Weekly Maintenance

1. To properly clean your humidifier, we recommend you to remove scale and disinfect the humidifier separately.
2. DO NOT mix vinegar and bleach solutions together. Do not use more than 1 tsp. of bleach per gallon of water to avoid damaging your humidifier.
3. Please make sure the rubber ring & rubber cap & spring on the tank cap is installed properly after cleaning to avoid water leakage. For more detailed information, please refer to the Troubleshooting Guide.

Scale Removal Instructions

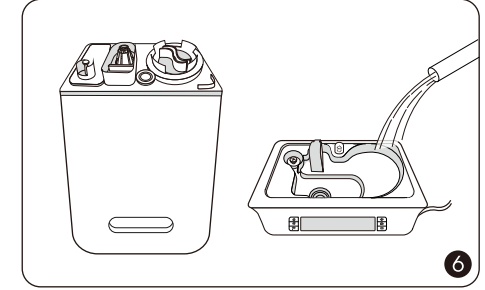
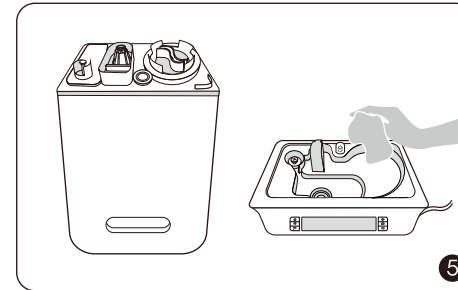
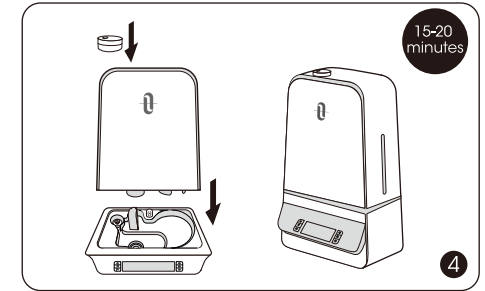
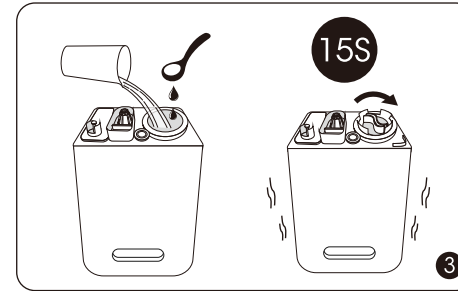
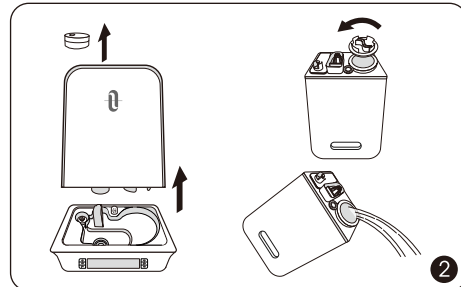
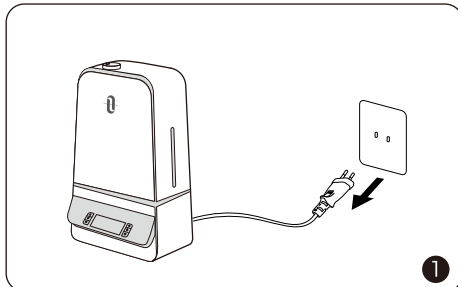

1. Turn off and unplug the humidifier. Remove the nozzle.
2. Remove the water tank from the base. Remove the tank cap. Make sure that the sealing ring does not come off. Drain water from the water tank and base. Remove any accessories and set aside.
3. Fill the water tank half full. Add in 1 teaspoon of undiluted distilled white vinegar. Attach the tank cap and shake for 15 seconds.
4. Place the tank onto the base. The vinegar solution will enter the water reservoir to loosen mineral buildup (scale) on the atomizer, water floater and the bottom of the water tank. Set still for 15-20 minutes.
5. Uncap the tank cap and drain the solution. Wipe the atomizer and floater with a soft cloth to remove loosened mineral deposits.
6. Rinse both the water reservoir and water tank until the smell of vinegar (for scale removal) or bleach solution (for disinfecting, see below) is gone.

Disinfecting Instructions

1. Follow steps 1-2 of the previous section on scale removal.
2. Fill the water tank half full. Add in ½ tsp of bleach. Place the tank cap back on. Swish the solution around in tank. Place the tank on the base. The bleach solution will enter and disinfect the water reservoir as well as the other components. Set still for 15-20 minutes.
3. Follow steps 4-6 of the previous section on scale removal to complete disinfecting the humidifier.

Clean the Dustproof Sponge

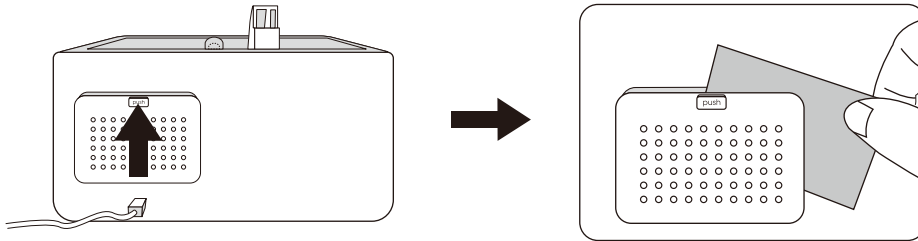

Clean the dustproof sponge (at the back of base) with water or detergent once a month. Put it back in place after cleaning.

End-Of-Season Care and Storage

1. Follow the cleaning instructions when the humidifier will not be used for at least one week, or at the end of the season. Remove any accessories used with the humidifier and allow the humidifier and accessories to dry completely before storing.
2. DO NOT store with water inside the base, water reservoir, or tank.
3. Pack the unit safely and store in a cool, dry location.

TROUBLESHOOTING GUIDE

1. If the information listed in the troubleshooting guide can't solve your problem, please email us for help.
2. Failure to keep this unit clean from mineral deposits may affect operation of this unit.
3. Customer failure to follow these instructions may void the warranty.

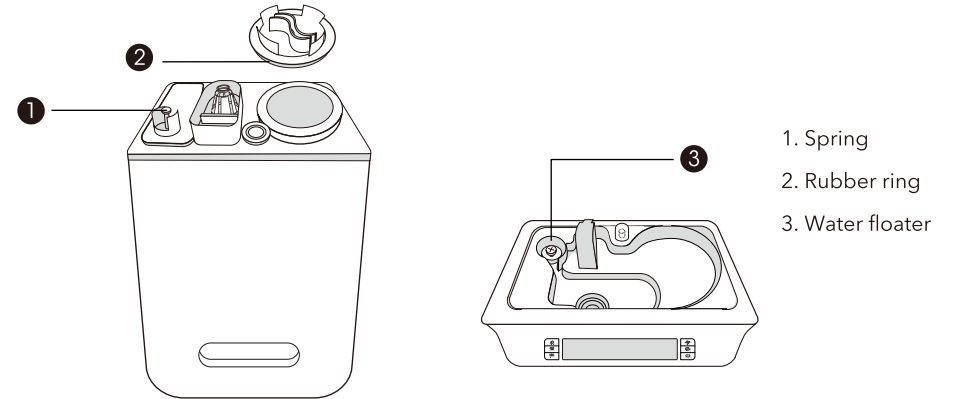

1. Spring
2. Rubber ring
3. Water floater

Problem	Possible Cause	Solution
LED display won't light up	Unit not plugged in	Ensure unit is properly plugged in
	No power from power outlet	Try another power outlet
Waterless indicator is constantly on	No water in the water reservoir	Ensure the ❶ spring is secured properly to the tank allowing water to pass through to the base
	❸ Water floater stuck	Adjust the ❸ water floater to a horizontal position and make sure it can rise up with water

LED display is on, no mist or little mist is produced	Not enough water inside the tank	Refill and reinstall the water tank
	Mist level is set too low	Adjust to maximum mist
	Preset humidity is set too low	Check if current humidity is higher than preset humidity, reset humidity to a higher level
	The base might be overfilled	Remove the tank, empty the base & replace the filled tank on the empty base
	Mineral buildup on atomizer	Feel if air comes out from the the nozzle, if yes, then clean water scale on the atomizer as instructed
Tank leakage	Tank may be damaged	Check for possible cracks in the tank, replace if necessary
	Tank cap is not tightened securely	Tighten the tank cap
	② Rubber ring was not installed on tank cap	Check the tank cap for rubber ring, rubber cap and spring, contact us if any is missing
	① Spring stuck	Ensure the ① spring is secured properly to the tank allowing water to pass through to the base
Mist height is low, damping surrounding desk or floor. Condensation forms around humidifier or on windows and walls	Mist level is set too high for the room size	1. Check if the room is too humid, adjust to lower mist, 40%-60% works best 2. Open door and windows, or change to a larger room
	Air inlet is blocked	Humidifier should be placed on a hard flat surface, 2 feet above the floor, 12 inches away from the wall. Point Mist Outlet away from wall or window
	Low indoor temperature leads to liquefaction	Raise the room temperature to 25°C/77°F

Poor humidification	Mist level is set too low for the room size	1-1. Adjust to maximum mist 1-2. Close door or windows to reduce air ventilation, or change to a smaller room
	Air inlet is blocked	Humidifier should be placed on a hard flat surface, 2 feet above the floor, 12 inches away from the wall
	Low indoor temperature leads to liquefaction	Raise the room temperature to 25°C/77°F
White Dust Appears / Black coating in the base flakes off	Tap water may contain too much minerals	Replace with filtered or distilled water or use with a TaoTronics Demineralization Cartridge
Strange Odor	Unit needs to be cleaned	Clean the humidifier as instructed
		Leave the empty water tank open in a cool place for 12 hours without the water tank cap attached
Strange water noise	Water is going down to the water reservoir	This is normal while it is working
Humidifier is getting too hot	Unit works for too long	Power off and place in a well-ventilated place for 10 minutes

WARRANTY

This product is covered with TaoTronics product and labor warranty for 12 months from the date of its original purchase. You will be given a warranty extension of 18 months if the product is registered on our website (www.taotronics.com).

Any defective part will be, at the discretion of **SUNVALLEYTEK INTERNATIONAL INC.**, repaired or replaced at no charge if the appliance has not been tampered with and has been used according to these printed directions.

If any problems occur, please contact TaoTronics support (support@taotronics.com) immediately to launch a warranty claim. Specify model number and your Amazon order number. Our Consumer Service Representative will respond within 1 business day, advise you how to correct the problem yourself, or instruct you on how to return the defective unit back to us for repair or replacement.

We can only provide after sales service for products that are sold by TaoTronics or TaoTronics authorized retailers and distributors. If you have purchased your unit from a different place, please contact your seller for return and warranty issues.

CONTACT / TAOTRONICS CUSTOMER CARE

PLEASE CONTACT US BEFORE RETURNING THIS PRODUCT TO THE STORE. EMAIL TAOTRONICS CUSTOMER CARE FOR PROBLEMS AND QUESTIONS. WE WILL RESPOND WITHIN 1 BUSINESS DAY.

E-mail: support@taotronics.com

Website: www.taotronics.com

FCC Compliance

This device complies with Part 15 of the FCC Rules. Operation is subject to the following two conditions:

- (1) This device may not cause harmful interference, and
- (2) This device must accept any interference received, including interference that may cause undesired operation.



WEEE Compliance

Correct Disposal of This Product (Waste Electrical & Electronic Equipment) (Applicable in countries with separate collection systems) This marking on the product, accessories or literature indicates that the product and its electronic accessories should not be disposed of with other household waste at the end of their working life. To prevent possible harm to the environment or human health from uncontrolled waste disposal, please separate these items from other types of waste and recycle them responsibly to promote the sustainable reuse of material resources. Household users should contact either the retailer where they purchased this product, or their local government office, for details of where and how they can take these items for environmentally safe recycling. Business users should contact their supplier and check the terms and conditions of the purchase contract. This product and its electronic accessories should not be mixed with other commercial wastes for disposal.

www.taotronics.com

尺寸:150*200mm

装订成册

材质:封面128克铜版纸 内页80克书纸

Model:
TT-AH044