











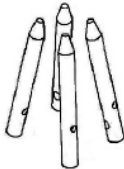

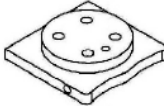

Thank you for choosing Sunnydaze Decor. We stand behind our brand and the quality of the items we sell. Replacement parts or products will be sent at our discretion, within the one-year warranty period. Proof of purchase, with the date of purchase as well as photos of the defective merchandise, must be provided.

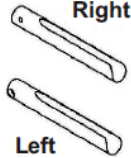
If you have any questions, comments or concerns please feel free to contact us by phone at: **888-881-4668**. You may also contact us by email: customerservice@serenityhealth.com, or via our webpage at: www.serenityhealth.com/contact-us/

DSL-650

PARTS:

PARTS LIST										HARDWARE	
 A (4PCS)	 B (4PCS)	 C (1PC)	 D (1PC)	 E (2PCS)	 F (3PCS)	 G (1PC)	 Right Left H (2PCS)	 I (2PCS)	 1 (4PCS)	 2 (27PCS)	
									 3 (2PCS)	 4 (4 PCS)	

ASSEMBLY INSTRUCTIONS:

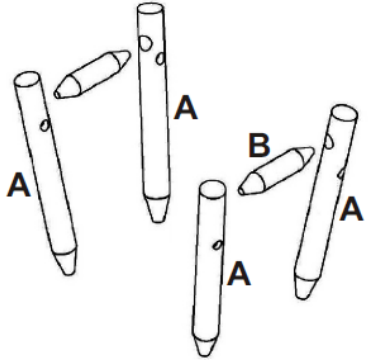
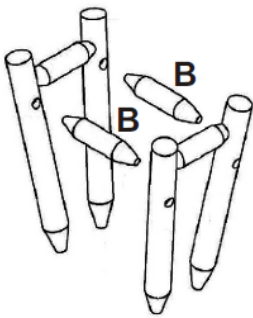
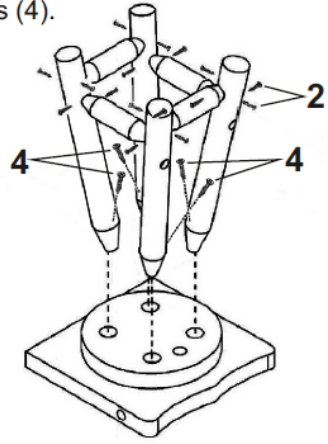
<p>STEP 1 Insert two Support Bars (B) into the two lower holes facing inward in each of the four Legs (A).</p> 	<p>STEP 2 Insert the remaining two Support Bars (B) into the upper holes facing each other in the four Legs (A).</p> 	<p>STEP 3 Secure all support bars and legs using 16pcs screws (2). Insert four legs into seat bottom and attach using 4pcs screws (4).</p> 
---	---	---

STEP 4

Attach 2 Back Posts (E) and 3 Back Rails (F) to Top Rail (G) using 5pcs Screws (2). Attach Back Rest to Seat (C) using 2pcs Screws (2). Attach Foot Rest (D) to front legs using 2pcs Bolt-Washer-Nut Sets (3). Do not over tighten screws/bolts until all parts assembled.

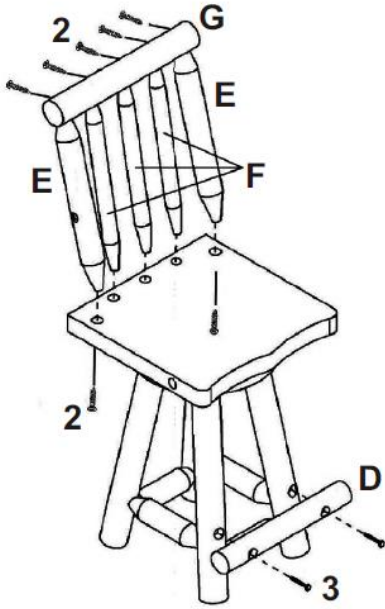

STEP 5

Attach the Right & Left Arms (H) to the two Back Posts (E) using 2pcs Bolt (1). Attach 2 Arm Supports (I) to Right & Left Arms (H) using 4pcs Screw (2). Attach Arm Supports (I) to Seat (C) using 2pcs Bolt (1),

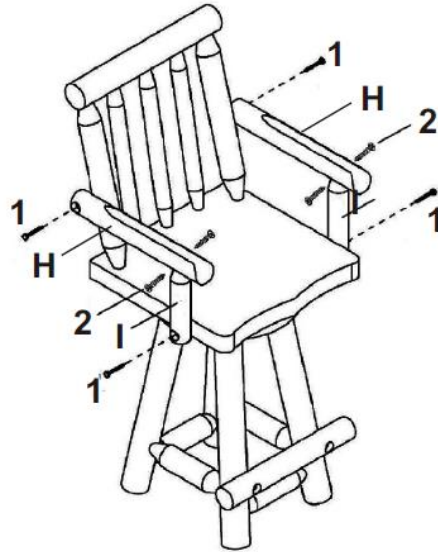

STEP 6

Finish tightening all screws and bolts to secure the back and arms. Assembly complete.

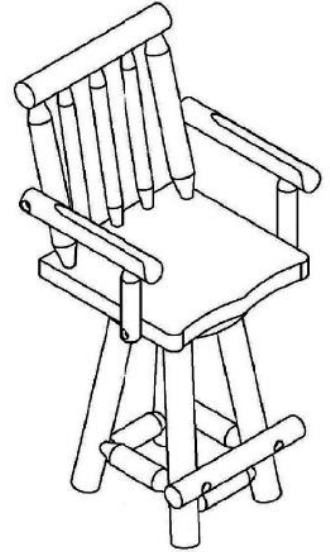

Made in China