



®



gaskets

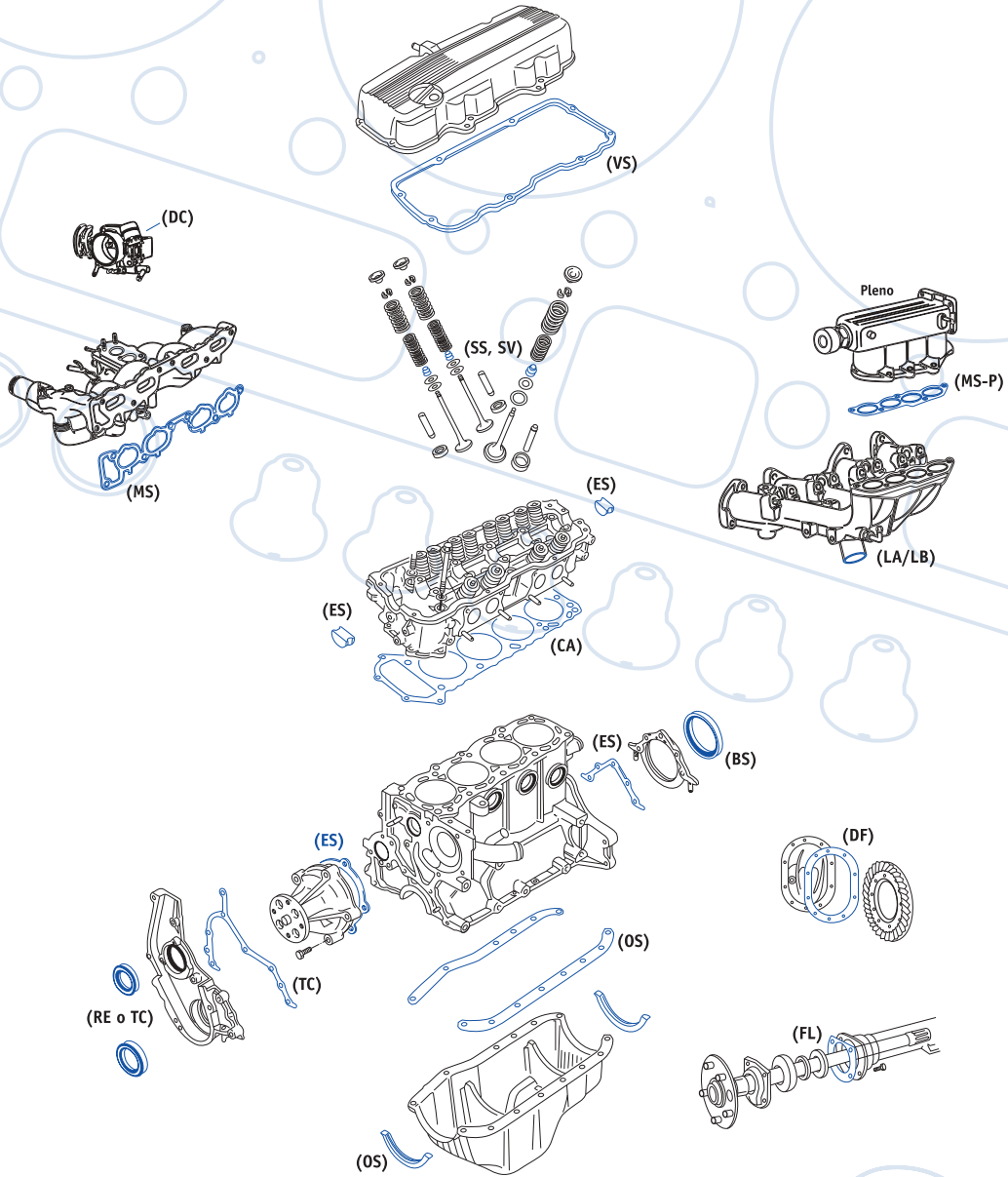

2017

**CATÁLOGO DE APLICACIONES
/ APPLICATIONS CATALOG**



- FS** _____ Juego Completo
Full Set 
- HS** _____ Juego Superior
Head Set 
- LS** _____ Juego Inferior
Lower Set 
- CA** _____ Junta de Cabeza
Head Gasket
- MS** _____ Múltiple de Admisión
Intake Manifold
- MS-E /MS-P** _____ Múltiple de Escape y Pleno
Exhaust and Plenum
- OS** _____ Cárter
Oil Pan Set

- VS** _____ Tapa de Punterías
Valve Cover
- TC** _____ Distribución
Timing Cover
- BS** _____ Retén Cigüeñal
Crank Seal
- RE** _____ Retén
Oil Seal
- SS - SV** _____ Sellos de Válvula
Valve Stem Seals
- LA - LB** _____ Aro / Tubo de Escape
Exhaust Ring / Gasket

DC: Junta de Carburador / Carburetor Gasket
 ES: Junta Varias / Miscellaneous Gaskets
 DF: Junta Diferencial / Differential Gasket
 FL: Junta Flecha Lateral / Shaft wheel Gasket

Juntas de Cabeza

Grafito con materiales premium en sus recubrimientos **epóxico termo estable** y resistente a la temperatura que ayuda al anclaje de su segundo recubrimientos de silicón para lograr un sellado eficiente.

Multilamina con acero de alta resistencia al igual que sus recubrimientos tales como: **FKR, NBR y Silicón**.

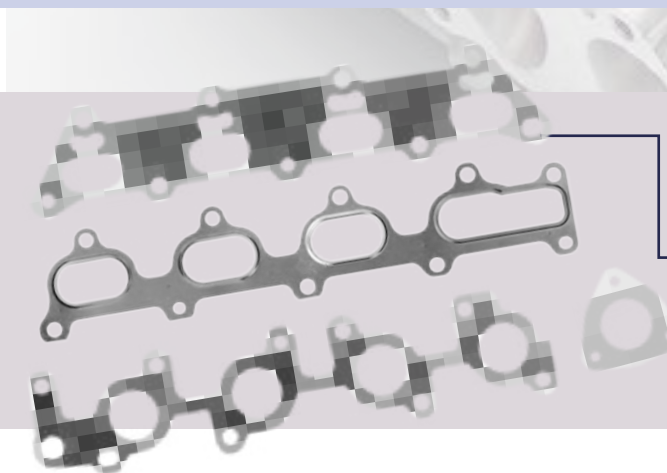
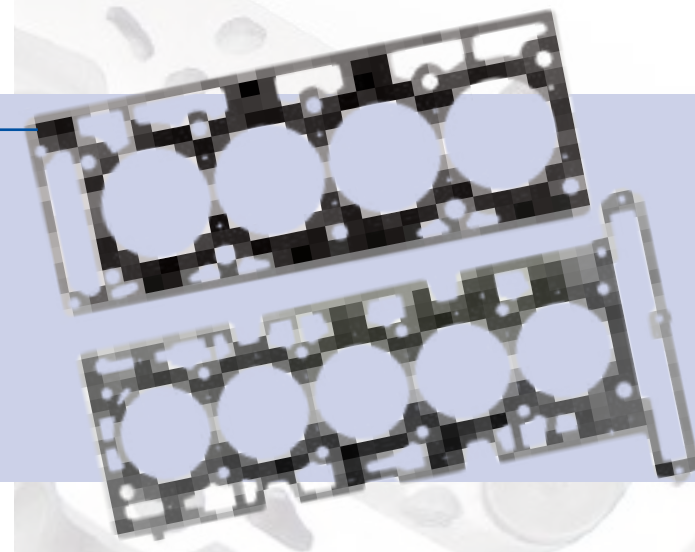

Múltiples aros y juntas planas de escape

Fabricados todos en **grafito expandido** que resiste muy elevadas temperaturas y con excelente compresibilidad para absorber imperfecciones en las superficies a sellar.

Admisión y empaques varios

Fabricados en **fibras sintéticas** que cubren requerimientos **ASTM** en resistencia a altas temperaturas y compresibilidad como principales características en el sellado.

Empaques en **Nylon-Silicón** o bien como sustituto en **diseño DC de multi-capas a base de fibras sintéticas, lámina y recubrimiento epóxico termo-estable** que cubren toda la superficie de sellado con mayor garantía de resistencia.

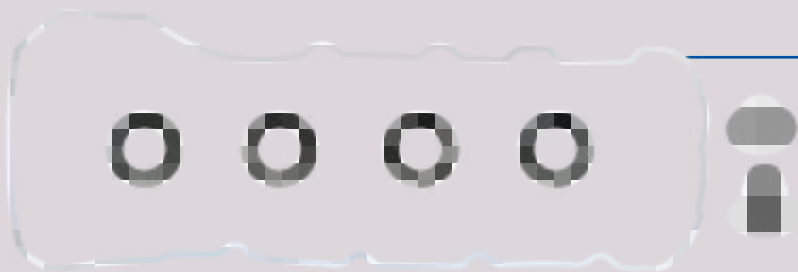
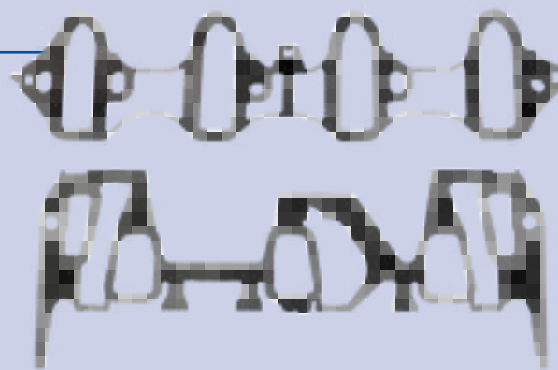

Juntas y sellos de hule

Se usan materias primas de alto desempeño para uso automotriz como son **Teflon®, Viton®, Silicón, Poli acrilato y Nitrilo**, entre otras.

*Teflon® es una marca registrada de DuPont.
Viton® es un producto de DuPont Performance Elastomers.*

Head Gaskets

Graphite with **premium materials** using the best thermal epoxy coating for a stable sealing and heat resistant working on his second silicone coating to achieve an efficient sealing.

MLS head gasket high performance steel and coating such as **FKM, NBR and Silicone**.

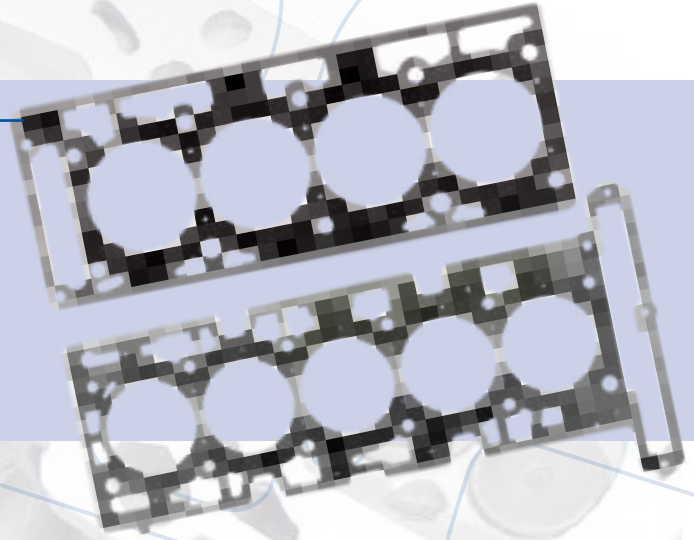

Exhaust Manifold, rings and exhaust flat gaskets

All manufactured in **expanded graphite** which resists high temperatures and excellent compressibility to absorb imperfections in the surfaces to be sealed.

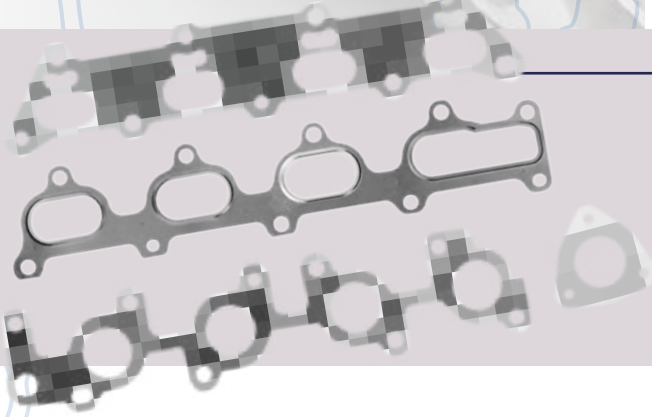

Intake and Miscellaneous gaskets

Various gaskets including the intake gaskets, are manufactured of synthetic fibers covering ASTM standards about high temperature resistance and compressibility as main characteristics for sealing requirements.

Nylon-Silicone gaskets or its substitute on DC design about multi layer of fiber and steel with a thermo stable epoxy coating achieving a performance sealing for covering entire sealing surface.

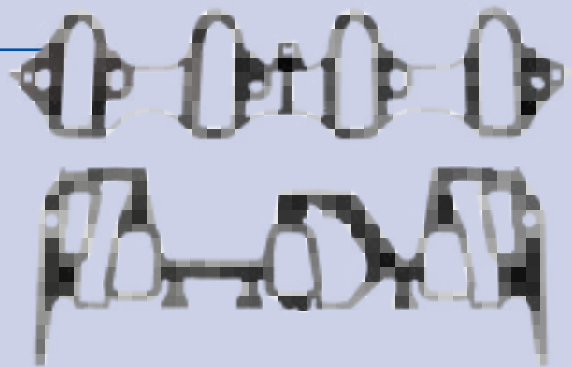

Rubber Gaskets and Seals

Manufactured with high performance materials for automotive use, Such as **Teflon®, Viton®, Silicone, Polyacrylate NBR**, and others.



* JUEGOS COMPLETOS



1.5L	MOTOR	MODELOS	DESDE / A	JUNTA DE CABEZA	MULTIPLE DE ADMISIÓN O PLENO
ENGINE	MODELS	FROM / TO	HEAD GASKET	INTAKE	
4L SOHC 8V E15	TSURU	1983/1985	CA-1216-G	MS-41216-A	
<p>FS-1216</p>					
MULTIPLE DE ESCAPE		PUNTERIAS		CARTER	
EXHAUST		VALVE COVER		OIL PAN	
MS-41216-E		VS-31216-R		OS-11216	
DISTRIBUCIÓN		RETÉN CIGÜENAL		SELLOS DE VALVULA	
TIMING COVER		CRANK SEAL		STEM SEALS	
TC-41216		BS-71216		SS-81216	
				JUNTAS VARIAS	
				MISCELLANEOUS	

- 01 Muestra que el catálogo esta ordenado por motor.
- 02 Litraje del motor, siendo ordenado de manera ascendente.
- 03 Indica las características del motor
- 04 Modelo
- 05 Año de la fabricación del motor y modelo.

* En cada indice por marca de la sección de **Juegos Completos** existe un código QR el cual al escanearlo con su spartphone lo dirigirá a la página del catálogo digital para una búsqueda más específica de juegos no impresos en este catálogo.

Identifiquelo con la siguiente imagen:



DC Gaskets		2017	INDICE / INDEX	
CATÁLOGO DE APLICACIONES / APPLICATION CATALOG		JUEGOS COMPLETOS / FULL SET		
TOYOTA				
LITROS	MODELO	AÑO	PAGINA	
LITERS	MODEL	YEAR	PAGE	
1.5L	TERCEL	1980/1988	*	
1.5L	TERCEL	1987/1994	*	
1.5L	TERCEL PRASEO	1992/1995	*	
1.5L	TERCEL PRASEO	1992/1999	*	
1.4L	CORDILLA CABINA	1977/1979	1	
1.6L	CORDILLA CELICA GEO PRIZM	1988/1993	*	
1.6L	CORDILLA PRIZM	1993/1997	*	
1.8L	CELICA CORDILLA MIRZ MATRIX PONTIAC VIBE PRIZM	1998/2009	*	
1.8L	CORDILLA CELICA GEO PRIZM	1993/1997	*	
2.0L	CELICA CAMRY	1983/1986	*	
2.0L	VAN CARGA	1984/1985	*	
2.0L	CAMRY CELICA MIRZ	1987/1991	1	
2.0L	RAV4	2001/2003	1	
2.3L	CELICA CORONA PICKUP	1979/1989	1	
2.3L	MIRZ TURBO	1991	*	
2.3L	VAN CARGA FRAGGEROS	1986/1989	1	
2.3L	CAMRY CELICA MIRZ	1991/1995	1	
2.4L	PICKUP CORONA CELICA	1981/1982	1	
2.4L	PICKUP CELICA HRUNNER	1983/1984	1	
2.4L	PICKUP CELICA HRUNNER	1985/1995	1	
2.4L	PRIZM	1991/1997	*	
2.4L	PANV CAMRY HIGHLANDER	2002/2007	*	
2.4L	TACOMA	1994/2004	*	
2.7L	TACOMA T100 HRUNNER	1994/2004	*	
2.7L	HILUX HILUX VENZA	2005/2010	1	
3.0L	HRUNNER PICKUP T100	1988/1995	1	
3.0L	SUPRA LEXUS SCION ESSO GSSGO	1991/1996	*	
3.0L	CAMRY LEXUS ESSO	1992/1995	*	
3.0L	CAMRY HRUNNER SERRAL SOLARA	1994/2000	*	
3.4L	TACOMA HRUNNER T100 TUNDRA	1995/2004	1	
4.0L	LEXUS LEXUS SCION	1990/1997	*	
4.0L	LEXUS GSAOL LEXUS SCION	1998/2000	*	
4.2L	LAND CRUISER	1980/1987	*	
4.7L	HINO SERIE 500	2009/2014	1	

NOTA: Asegúrese de colocar correctamente la imagen, para una lectura correcta.

* Otra manera de dirigirse a nuestro catálogo digital es en: catalogo.dcp.com.mx

En cualquiera de estas dos opciones le deberá arrojar la siguiente pantalla:



* FULL SET



1.5L	MOTOR	MODELOS	DESDE / A	JUNTA DE CABEZA	MÚLTIPLE DE ADMISIÓN O PLENO									
ENGINE	MODELS	FROM / TO	HEAD GASKET	INTAKE										
4L SOHC 8V E15	TSURU I	1983/1987	CA-1216-G	MS-41216-A										
FS-1216			<table border="1"> <tr> <th>MÚLTIPLE DE ESCAPE</th> <th>PUNTERIAS</th> <th>CARTER</th> </tr> <tr> <th>EXHAUST</th> <th>VALVE COVER</th> <th>OIL PAN</th> </tr> <tr> <td>MS-41216-E</td> <td>VS-31216-R</td> <td>OS-11216</td> </tr> </table>			MÚLTIPLE DE ESCAPE	PUNTERIAS	CARTER	EXHAUST	VALVE COVER	OIL PAN	MS-41216-E	VS-31216-R	OS-11216
MÚLTIPLE DE ESCAPE	PUNTERIAS	CARTER												
EXHAUST	VALVE COVER	OIL PAN												
MS-41216-E	VS-31216-R	OS-11216												
DISTRIBUCIÓN			SELLOS DE VALVULA											
TIMING COVER			STEM SEALS											
TC-41216			SS-81216											
RETÉN CIGÜERAL			JUNTAS VARIAS											
CRANK SEAL			MISCELLANEOUS											
BS-71216														

- 01 Shows the catalog is ordered by engine.
- 02 Engine litres, in ascending form.
- 03 Indicates engine especifications.
- 04 Car and truck models.
- 05 Year reference of engine and model.

* Each Make index in the Full Set Section, will shows a QR code to be scanned by smartphones and redirecting you to the website (Digital Catalog) with a new sort for all the Full Sets does not show in this catalog.

QR image reference.



LITROS	MODELO	AÑO	PÁGINA
LITERS	MODEL	YEAR	PAGE
1.5L	TERCEL	1980/1988	*
1.5L	TERCEL	1987/1994	*
1.5L	TERCEL PASO	1992/1995	*
1.5L	TERCEL PASO	1995/1999	*
1.6L	COROLLA CARINA	1977/1979	1
1.6L	COROLLA CELICA GEO PRIZM	1988/1993	*
1.6L	COROLLA PRIZM	1993/1997	*
1.6L	CELICA COROLLA MRZ MATRIX PONTIAC VIBE PRIZM	1998/2009	*
1.6L	COROLLA CELICA GEO PRIZM	1993/1997	*
2.0L	CELICA CAMRY	1983/1988	*
2.0L	WAN CARGA	1984/1985	*
2.0L	CAMRY CELICA MRZ	1987/1993	1
2.0L	BAVA	2001/2003	1
2.2L	CELICA CORONA PICK-UP	1975/1980	*
2.2L	MRZ TURBO	1991	*
2.3L	WAN CARGA / PASAJEROS	1986/1989	1
2.3L	CAMRY CELICA MRZ	1993/1995	1
2.4L	PICK-UP CORONA CELICA	1981/1982	1
2.4L	PICK-UP CELICA 4RUNNER	1983/1984	1
2.4L	PICK-UP CELICA 4RUNNER	1985/1995	1
2.4L	PRIUSA	1991/1997	1
2.4L	BAVA CAMRY HIGHLANDER	2002/2007	*
2.4L	TACOMA	1994/2004	*
2.7L	TACOMA 4 RUNNER	1994/2004	*
2.7L	HRACE HELLUX VENZA	2005/2010	1
3.0L	4RUNNER PICK-UP 4100	1988/1995	1
3.0L	SUBARU LEXUS SCION ESQO G5500	1993/1998	*
3.0L	CAMRY LEXUS ESTOZ	1992/1998	*
3.0L	CAMRY 4RUNNER SUBARU SCION	1994/2000	*
3.4L	TACOMA 4RUNNER 4100 TUNDRA	1995/2004	1
4.0L	LEXUS LEXUS SC400	1990/1997	*
4.0L	LEXUS GLEAM LEXUS SC400	1988/2000	*
4.0L	LAND CRUISER	1988/1992	*
4.2L	LAND CRUISER	1983/1987	*
4.7L	HINO SERBI 500	2000/2014	1

NOTE: Make sure to have the QR image in the correctly position for a success reading.

* Another way to link our digital catalog is at: catalogo.dcp.com.mx

In either of these two options will display the following screen:



NOMENCLATURA / NOMENCLATURE _____ (I)

MATERIALES Y ATRIBUTOS / MATERIALS AND ATTRIBUTES _____ (III)

COMO USAR ESTE CATÁLOGO / HOW TO USE THIS CATALOG _____ (V)

INDICE GENERAL / GENERAL INDEX _____ (VII)

SECCIÓN JUEGOS COMPLETOS / FULL SETS SECTION

-AMC JEEP _____ (1)

-CHRYSLER _____ (13)

-FORD _____ (49)

-CHEVROLET _____ (91)

-HONDA _____ (133)

-ISUZU _____ (139)

-MAZDA _____ (145)

-NISSAN _____ (153)

-RENAULT _____ (173)

-TOYOTA _____ (179)

-VOLKSWAGEN _____ (191)

JUNTAS DE CABEZA / HEAD GASKETS _____ (203)

JUNTAS EN SOBREMEDIDA / OVER SIZE HEAD GASKETS _____ (273)

APLICACIONES DIESEL / DIESEL APPLICATIONS _____ (279)

SELLOS DE VÁLVULA / STEAM SEALS _____ (289)

RETENES / OIL SEALS _____ (301)

JUNTAS DE ESCAPE / EXHAUST GASKETS _____ (305)

INTERCAMBIOS / INTERCHANGES _____ (325)



AMC, JEEP

MARCA
/MAKE

CATÁLOGO DE APLICACIONES / APPLICATION CATALOG



LITROS	MODELO	AÑO	PÁGINA
LITERS	MODEL	YEAR	PAGE
2.5L	EAGLE, WAGONEER, CHEROKEE, WRANGLER	1983/1985	5
2.5L	COMANCHE, CJ7, WRANGLER, WAGONEER	1986/1990	5
3.2L	EAGLE, RAMBLER AMERICAN, PACER, AMBASSADOR, JAVELIN	1965/1983	6
3.7 L	DAKOTA, RAM 1500, JEEP LIBERTY (CABEZA EN GRAFITO)	2002/2005	*
3.7L	DAKOTA, RAM 1500, JEEP LIBERTY (CABEZA EN MLS)	2002/2005	*
3.8L	EAGLE, RAMBLER AMERICAN, PACER, AMBASSADOR, JAVELIN	1965/1983	6
4.0L	EAGLE, CHEROKEE, WAGONEER, COMANCHE	1987/1990	7
4.0L	EAGLE, CHEROKEE, COMANCHE, WRANGLER	1991/1995	7
4.0L	CHEROKEE, WRANGLER	1996/1998	8
4.0L	CHEROKEE, WRANGLER	1999/2006	8
4.2L	EAGLE, RAMBLER AMERICAN, PACER, AMBASSADOR, JAVELIN	1965/1983	9
4.2L	EAGLE, WRANGLER, CJ7, J10	1986/1988	9
4.2L	EAGLE, GRAND WAGONEER, WRANGLER	1985/1989	10
4.6L	EAGLE, RAMBLER AMERICAN, PACER, WAGONEER, JAVELIN	1965/1987	10
4.7L	RAM 1500, 2500, GRAND CHEROKEE, DURANGO, DAKOTA (CABEZA EN GRAFITO)	1999/2005	*
4.7L	RAM 1500, 2500, GRAND CHEROKEE, DURANGO, DAKOTA (CABEZA EN MLS)	1999/2005	*
5.6L	AMBASSADOR, JAVELIN, RAMBLER	1967/1974	*
5.2L	RAM 1500, 2500, 3500, DURANGO, GRAND CHEROKEE, B1500, 2500, 3500.	1992/2002	*
5.7L	RAM 1500, 2500, 3500, DURANGO, GRAND CHEROKEE, COMANDER	2003/2009	*
5.9L	AMBASSADOR, JAVELIN, MATADOR, CHEROKEE, WAGONEER, GRAND WAGONNER.	1971/1991	11
6.4L	AMBASSADOR, JAVELIN, RAMBLER.	1971/1978	*
6.6L	AMBASSADOR, JAVELIN, MATADOR, CHEROKEE, WAGONNER.	1971/1983	*



2.5L	MOTOR	MODELOS	DESDE / A	JUNTA DE CABEZA	MULTIPLE DE ADMISIÓN O PLENO	
ENGINE	MODELS	FROM / TO	HEAD GASKET	INTAKE		
4L AMC OHV 8V VIN U,C	EAGLE, WAGONEER, CHEROKEE, WRANGLER	1983/1985	CA-703-G	MS-4703		
FS-703 						
			MULTIPLE DE ESCAPE	PUNTERIAS	CARTER	
			EXHAUST	VALVE COVER	OIL PAN	
			N/A	VS-3703-R	OS-1703	
			N/A			
DISTRIBUCIÓN		RETÉN CIGÜEÑAL		SELLOS DE VALVULA		JUNTAS VARIAS
TIMING COVER		CRANK SEAL		STEM SEALS		MISCELLANEOUS
TC-6710		BS-7703		SS-8140-8P		

2.5L	MOTOR	MODELOS	DESDE / A	JUNTA DE CABEZA	MULTIPLE DE ADMISIÓN O PLENO	
ENGINE	MODELS	FROM / TO	HEAD GASKET	INTAKE		
4L AMC OHV 8V VIN U, H	COMANCHE, CJ7, WRANGLER, WAGONEER	1986/1990	CA-703-G	MS-4703		
FS-703-1 						
			MULTIPLE DE ESCAPE	PUNTERIAS	CARTER	
			EXHAUST	VALVE COVER	OIL PAN	
			N/A	VS-3703-R	OS-1703	
			N/A			
DISTRIBUCIÓN		RETÉN CIGÜEÑAL		SELLOS DE VALVULA		JUNTAS VARIAS
TIMING COVER		CRANK SEAL		STEM SEALS		MISCELLANEOUS
TC-6710		BS-7703		SS-8140-8P		



3.2L	MOTOR	MODELOS	DESDE / A	JUNTA DE CABEZA		MULTIPLE DE ADMISIÓN O PLENO
ENGINE	MODELS	FROM / TO	HEAD GASKET		INTAKE	
L6 OHV 12V 199"	EAGLE, RAMBLER AMERICAN, PACER, AMBASSADOR, JAVELIN	1965/1983	CA-710-G		MS-4711	
FS-710						
			MULTIPLE DE ESCAPE	PUNTERIAS	CARTER	
			EXHAUST	VALVE COVER	OIL PAN	
			N/A	VS-3710	OS-1710	
			N/A			
DISTRIBUCIÓN	RETÉN CIGÜEÑAL		SELLOS DE VALVULA	JUNTAS VARIAS		
TIMING COVER	CRANK SEAL		STEM SEALS	MISCELLANEOUS		
TC-6710	BS-7710		SS-8710			

3.8L	MOTOR	MODELOS	DESDE / A	JUNTA DE CABEZA		MULTIPLE DE ADMISIÓN O PLENO
ENGINE	MODELS	FROM / TO	HEAD GASKET		INTAKE	
L6 OHV 12V 232"	EAGLE, RAMBLER AMERICAN, PACER, AMBASSADOR, JAVELIN	1965/1983	CA-710-G		MS-4711	
FS-710						
			MULTIPLE DE ESCAPE	PUNTERIAS	CARTER	
			EXHAUST	VALVE COVER	OIL PAN	
			N/A	VS-3710	OS-1710	
			N/A			
DISTRIBUCIÓN	RETÉN CIGÜEÑAL		SELLOS DE VALVULA	JUNTAS VARIAS		
TIMING COVER	CRANK SEAL		STEM SEALS	MISCELLANEOUS		
TC-6710	BS-7710		SS-8710			



4.0L	MOTOR	MODELOS	DESDE / A	JUNTA DE CABEZA		MULTIPLE DE ADMISIÓN O PLENO
ENGINE	MODELS	FROM / TO	HEAD GASKET		INTAKE	
L6 AMC OHV 12V 242"	EAGLE, CHEROKEE, WAGONEER, COMANCHE	1987/1990	CA-715-G		MS-4715	
FS-715						
MULTIPLE DE ESCAPE		PUNTERIAS		CARTER		
EXHAUST		VALVE COVER		OIL PAN		
N/A		VS-003715		OS-1710		
N/A						
DISTRIBUCIÓN		RETÉN CIGÜEÑAL		SELLOS DE VALVULA		JUNTAS VARIAS
TIMING COVER		CRANK SEAL		STEM SEALS		MISCELLANEOUS
TC-6710		BS-7710		SS-8141-V		









4.0L	MOTOR	MODELOS	DESDE / A	JUNTA DE CABEZA		MULTIPLE DE ADMISIÓN O PLENO
ENGINE	MODELS	FROM / TO	HEAD GASKET		INTAKE	
L6 AMC OHV 12V 242"	EAGLE, CHEROKEE, COMANCHE, WRANGLER	1991/1995	CA-715-G		MS-4715-1	
FS-715-1						
MULTIPLE DE ESCAPE		PUNTERIAS		CARTER		
EXHAUST		VALVE COVER		OIL PAN		
N/A		VS-3715		OS-1715-R		
N/A						
DISTRIBUCIÓN		RETÉN CIGÜEÑAL		SELLOS DE VALVULA		JUNTAS VARIAS
TIMING COVER		CRANK SEAL		STEM SEALS		MISCELLANEOUS
TC-6710		BS-7710		SS-8141-V		

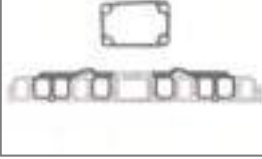







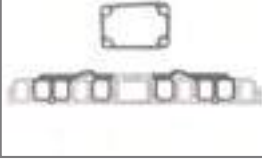

4.0L	MOTOR	MODELOS	DESDE / A	JUNTA DE CABEZA		MÚLTIPLE DE ADMISIÓN O PLENO	
ENGINE	MODELS	FROM / TO	HEAD GASKET		INTAKE		
L6 AMC OHV 12V 242"	CHEROKEE, WRANGLER	1996/1998	CA-715-G		MS-4715-1		
FS-715-2			MÚLTIPLE DE ESCAPE	PUNTERIAS	CARTER		
			EXHAUST	VALVE COVER	OIL PAN		
			N/A	VS-3715	OS-1715-R		
			N/A				
DISTRIBUCIÓN		RETÉN CIGÜEÑAL		SELLOS DE VALVULA		JUNTAS VARIAS	N/A
TIMING COVER		CRANK SEAL		STEM SEALS		MISCELLANEOUS	
TC-6710		BS-7715		SS-8141-V		N/A	

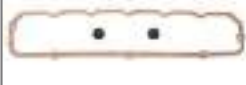







4.0L	MOTOR	MODELOS	DESDE / A	JUNTA DE CABEZA		MÚLTIPLE DE ADMISIÓN O PLENO	
ENGINE	MODELS	FROM / TO	HEAD GASKET		INTAKE		
L6 OHV 12V 242"	CHEROKEE, WRANGLER	1999/2006	CA-715-G		MS-004715-2		
FS-715-3			MÚLTIPLE DE ESCAPE	PUNTERIAS	CARTER		
			EXHAUST	VALVE COVER	OIL PAN		
			N/A	VS-3715-1R	OS-1715-R		
			N/A				
DISTRIBUCIÓN		RETÉN CIGÜEÑAL		SELLOS DE VALVULA		JUNTAS VARIAS	N/A
TIMING COVER		CRANK SEAL		STEM SEALS		MISCELLANEOUS	
TC-6710		BS-7715				N/A	



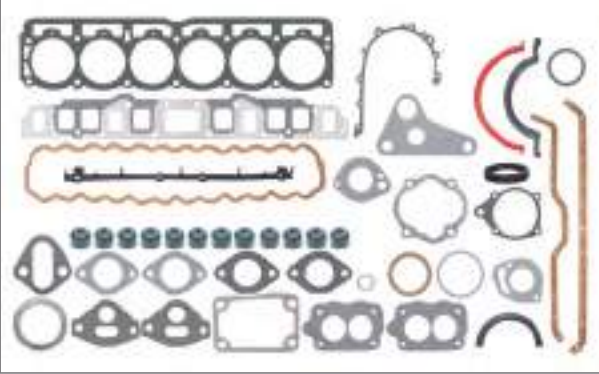

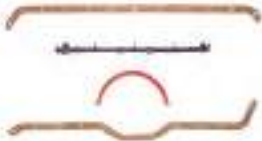





4.2L	MOTOR	MODELOS	DESDE / A	JUNTA DE CABEZA	MULTIPLE DE ADMISIÓN O PLENO
ENGINE	MODELS	FROM / TO	HEAD GASKET	INTAKE	
L6 OHV 12V 258"	EAGLE, RAMBLER AMERICAN, PACER, AMBASSADOR, JAVELIN	1965/1983	CA-710-G 	MS-4711 	
FS-710 			MULTIPLE DE ESCAPE EXHAUST N/A	PUNTERIAS VALVE COVER VS-3710 	CARTER OIL PAN OS-1710 
DISTRIBUCIÓN TIMING COVER TC-6710 	RETÉN CIGÜEÑAL CRANK SEAL BS-7710 	SELLOS DE VALVULA STEM SEALS SS-8710 	JUNTAS VARIAS MISCELLANEOUS 		

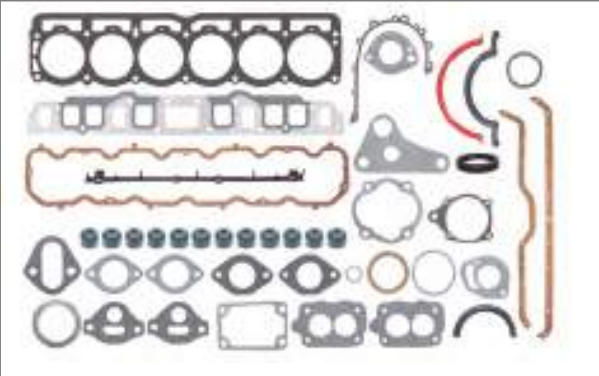

4.2L	MOTOR	MODELOS	DESDE / A	JUNTA DE CABEZA	MULTIPLE DE ADMISIÓN O PLENO
ENGINE	MODELS	FROM / TO	HEAD GASKET	INTAKE	
L6 OHV 12V 258"	EAGLE, WRANGLER, CJ7, J10	1986/1988	CA-710-G 	MS-4711 	
FS-710-1 			MULTIPLE DE ESCAPE EXHAUST ** N/A **	PUNTERIAS VALVE COVER VS-3711 	CARTER OIL PAN OS-1710 
DISTRIBUCIÓN TIMING COVER TC-6710 	RETÉN CIGÜEÑAL CRANK SEAL BS-7710 	SELLOS DE VALVULA STEM SEALS SS-8710 	JUNTAS VARIAS MISCELLANEOUS 		



4.2L	MOTOR	MODELOS	DESDE / A	JUNTA DE CABEZA	MULTIPLE DE ADMISIÓN O PLENO
ENGINE	MODELS	FROM / TO	HEAD GASKET	INTAKE	
L6 OHV 12V 258"	EAGLE, GRAND WAGONEER, WRANGLER	1985/1989	CA-710-G 	MS-4711 	
FS-710-2 			MULTIPLE DE ESCAPE EXHAUST N/A	PUNTERIAS VALVE COVER VS-3715 	CARTER OIL PAN OS-1710 
DISTRIBUCIÓN TIMING COVER TC-6710 	RETÉN CIGÜEÑAL CRANK SEAL BS-7710 	SELLOS DE VALVULA STEM SEALS SS-8710 	JUNTAS VARIAS MISCELLANEOUS 		

4.6L	MOTOR	MODELOS	DESDE / A	JUNTA DE CABEZA	MULTIPLE DE ADMISIÓN O PLENO
ENGINE	MODELS	FROM / TO	HEAD GASKET	INTAKE	
L6 OHV 12V 282"	EAGLE, RAMBLER AMERICAN, PACER, WAGONEER, JAVELIN	1965/1987	CA-710-G 	MS-4711 	
FS-710 			MULTIPLE DE ESCAPE EXHAUST N/A	PUNTERIAS VALVE COVER VS-3710 	CARTER OIL PAN OS-1710 
DISTRIBUCIÓN TIMING COVER TC-6710 	RETÉN CIGÜEÑAL CRANK SEAL BS-7710 	SELLOS DE VALVULA STEM SEALS SS-8710 	JUNTAS VARIAS MISCELLANEOUS 		

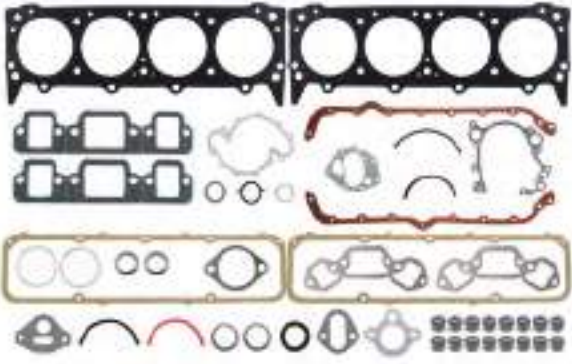

5.9L	MOTOR	MODELOS	DESDE / A	JUNTA DE CABEZA	MULTIPLE DE ADMISIÓN O PLENO	
ENGINE	MODELS	FROM / TO	HEAD GASKET	INTAKE		
V8 OHV 16V 360"	AMBASSADOR, JAVELIN, MATADOR, CHEROKEE, WAGONEER, GRAND WAGONNER	1971/1991	<p>CA-718-G</p> 			
<p>FS-718</p> 				<p>MULTIPLE DE ESCAPE</p> <p>EXHAUST</p>	<p>PUNTERIAS</p> <p>VALVE COVER</p>	<p>CARTER</p> <p>OIL PAN</p> <p>OS-1718</p> 
<p>DISTRIBUCIÓN</p> <p>TIMING COVER</p>		<p>RETÉN CIGÜEÑAL</p> <p>CRANK SEAL</p> <p>BS-7718</p>		<p>SELLOS DE VALVULA</p> <p>STEM SEALS</p>	<p>JUNTAS VARIAS</p> <p>MISCELLANEOUS</p>	



NOTAS / NOTES:

Lined area for notes and application details.

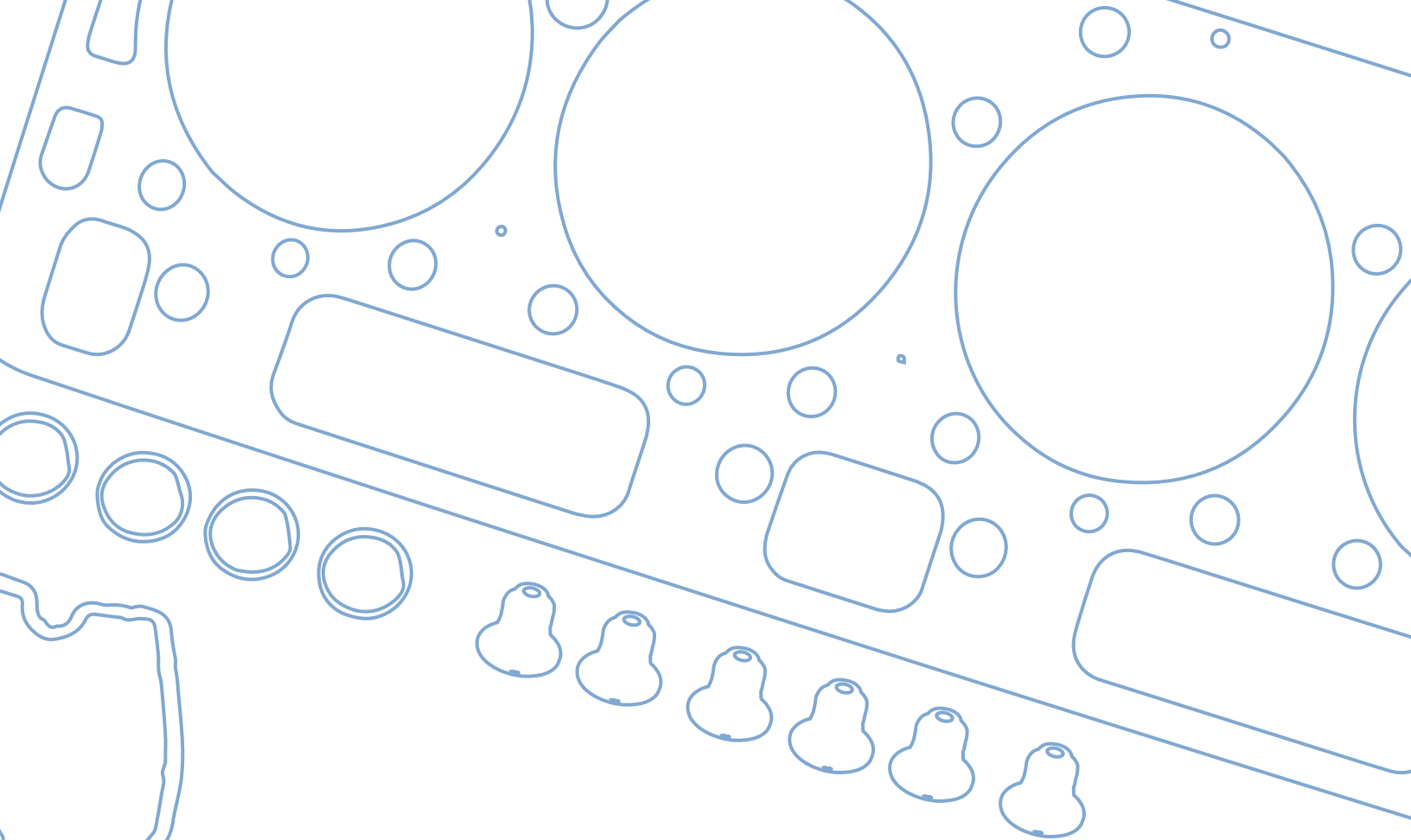

— ■ CHRYSLER DODGE

**MARCA
/MAKE**

CATÁLOGO DE APLICACIONES / APPLICATION CATALOG

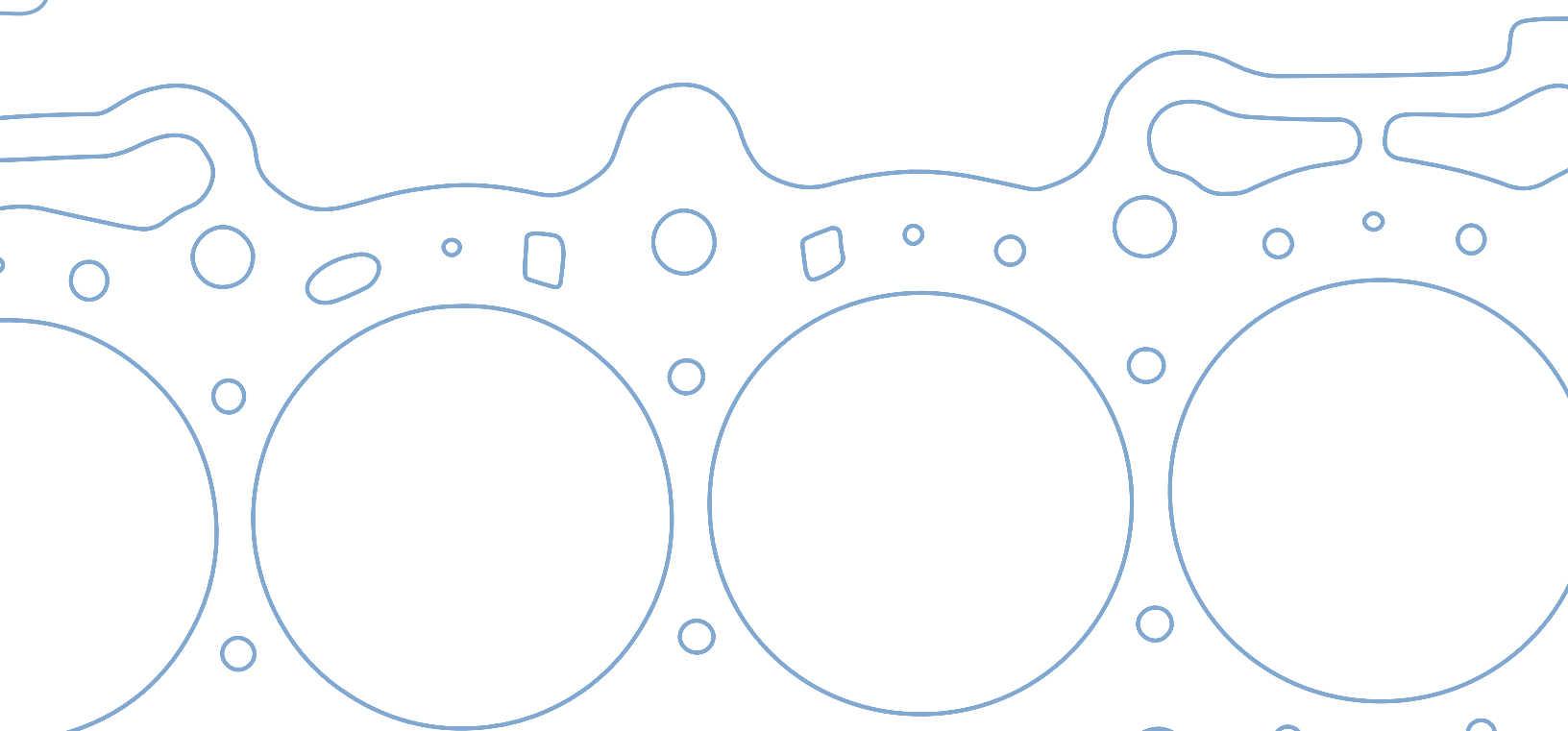



LITROS	MODELO	AÑO	PÁGINA
LITERS	MODEL	YEAR	PAGE
1.0L	ATOS	2000/2003	19
1.1L	ATOS	2004/2009	19
1.2L	i 10	2012/2014	20
1.4L	ATTITUDE	2006/2011	20
1.4L	COLT, MIRAGE, EXCEL	1979/1991	21
1.5L	VERNA	2000/2006	21
1.5L	MIRAGE	1997/2002	*
1.5L	COLT, MIRAGE, EXCEL	1979/1984	22
1.5L	COLT, MIRAGE, VISTA	1985/1990	22
1.5L	COLT, MIRAGE, VISTA	1991/1996	23
1.8L	EXPO, COLT, MIRAGE	1993/1996	*
1.8L	MIRAGE	1997/2002	*
1.8L	ELANTRA, TIBURON	1998/2002	*
1.8L	ECLIPSE, TALON, COLT, LASER	1989/1994	23
2.0L	COLT, VISTA, GALANT, 2000GTX, STELLAR	1984/1990	24
2.0L	ECLIPSE, GALANT, 2000 GTX, TALON	1990/1994	24
2.0L	ECLIPSE, EAGLE TALON	1993/1999	25
2.0L	NEON, SEBRING	1995/1999	*
2.0L	NEON, STRATUS, BREEZE	1996/2000	*
2.0L	NEON	1996/1999	25
2.0L	NEON, CIRRUS, STRATUS	1999/2005	26
2.2L	VOYAGER, DART K, SHADOW, SPIRIT, DAYTONA, LeBARON	1981/1988	26
2.2L	SHADOW, DART K, LeBARON, TOWN & COUNTRY, LANCER	1983/1990	27
2.2L	SHADOW, VOYAGER, SPIRIT, DAKOTA, PHANTOM, LeBARON	1990/1995	27
2.4L	H-100	2003/2005	28
2.4L	PATRIOT, JOURNEY, COMPASS, CALIBER, AVENGER (CABEZA EN GRAFITO)	2007/2013	28
2.4L	PATRIOT, JOURNEY, COMPASS, CALIBER, AVENGER (CABEZA EN MLS)	2007/2013	29
2.4L	PT CRUISER	2001	*
2.4L	STRATUS, CIRRUS, VOYAGER, SEBRING	1995/2000	29
2.4L	PT CRUISER (CABEZA EN MLS)	2002/2007	30
2.4L	PT CRUISER (CABEZA EN GRAFITO)	2002/2007	30
2.4L	ECLIPSE, GALANT, OUTLANDER, LANCER	2005/2009	31
2.4L	ECLIPSE, GALANT, SEBRING	2001/2005	*
2.5L	H-100	2005/2009	31
2.5L	VOYAGER, DART K, SHADOW, SPIRIT, DAYTONA, LeBARON	1981/1988	32
2.5L	SHADOW, DART K, LeBARON, TOWN & COUNTRY, LANCER	1983/1990	32
2.5L	SHADOW, VOYAGER, SPIRIT, DAKOTA, PHANTOM, LeBARON	1990/1995	33
2.5L	STRATUS, CIRRUS, SEBRING	1995/2000	33
2.6L	CARAVAN, VOYAGER, LeBARON, RAM 50	1981/1989	34
2.7L	INTREPID, CONCORDE	1998/2000	34
2.7L	INTREPID, CONCORDE, SEBRING, CIRRUS	2001/2010	35
2.8L	DART, LANCER, BARRACUDA	1960/1984	*
3.0L	CARAVAN, VOYAGER, LeBARON, DYNASTY	1987/1995	35
3.0L	GRAND CARAVAN, SHADOW, SPIRIT, GRAND VOYAGER, LeBARON.	1987/1995	36



LITROS	MODELO	AÑO	PÁGINA
LITERS	MODEL	YEAR	PAGE
3.0L	MONACO, EAGLE PREMIER	1990/1992	36
3.2L	RAM CHARGER, CHALLENGER, CHARGER, CORONET, BARRACUDA, AUTOS Y CAMIONES TODOS	1960/1984	*
3.2L	INTREPID, CONCORDE	1998/2001	*
3.3L	GRAND CARAVAN, GRAND VOYAGER	1990/2000	37
3.3L	TOWN & COUNTRY, CARAVAN, VOYAGER	2001/2010	*
3.5L	CONCORDE, INTREPID (CABEZAS DE MLS)	1993/1997	*
3.5L	INTREPID, CONCORDE, NEW YORKER	1993/1997	37
3.5L	JOURNEY, AVENGER, SEBRING, CHARGER, CHALLENGER	2007/2010	38
3.6L	CORONET, CUSTOM, DELUXE	1952/1960	*
3.6L	TOWN & COUNTRY, CARAVAN, AVENGER, JOURNEY, CHALLENGER, RAM 1500, 200	2011/2013	38
3.7L	DART, RAM CHARGER, CHALLENGER, CHARGER, CORONET, BARRACUDA, AUTOS Y CAMIONES TODOS.	1960/1984	*
3.7L	D-150, D-250, B150, B250	1981/1991	39
3.7L	DAKOTA, RAM 1500, JEEP LIBERTY (CABEZA EN GRAFITO)	2002/2005	39
3.7L	DAKOTA, RAM 1500, JEEP LIBERTY (CABEZA EN MLS)	2002/2005	40
3.7L	DAKOTA, RAM 1500, NITRO	2006/2012	40
3.8L	CORONET, CUSTOM, DELUXE	1952/1960	*
3.8L	TOWN & COUNTRY, GRAND CARAVAN, GRAND VOYAGER (CARTER Y PUNTERIAS DE SILICON).	1998/2000	41
3.8L	TOWN & COUNTRY, GRAND CARAVAN, PACIFICA	2002/2008	*
3.8L	TOWN & COUNTRY, CARAVAN, VOYAGER (CARTER Y PUNTERIAS DE CORCHO).	1994/2001	41
3.9L	DAKOTA AMERICANAS, B150, B250	1987/1989	42
3.9L	RAM VAN, W150, D150, D250	1990/1991	42
3.9L	DAKOTA, RAM 1500, RAM VAN	1992/2001	43
4.1L	NEWPORT, TOWN & COUNTRY, WINDSOR	1954/1960	*
4.3L	NEWPORT, TOWN & COUNTRY, WINDSOR	1954/1960	*
4.5L	VALIANT, DART, CHARGER, BARRACUDA, MONACO, CORONET	1964/1969	*
4.7L	RAM 1500, 2500, GRAND CHEROKEE, DURANGO, DAKOTA (CABEZA EN GRAFITO)	1999/2005	43
4.7L	RAM 1500, 2500, GRAND CHEROKEE, DURANGO, DAKOTA (CABEZA EN MLS)	1999/2005	44
5.2L	CORONET, CHARGER, SERIES D100, D200, D300	1959/1966	*
5.2L	VALIANT, DART, CHARGER, BARRACUDA, MONACO, CORONET	1964/1969	*
5.2L	CORONET, CHALLENGER, CHARGER, BARRACUDA	1967/1978	*
5.2L	B150, B250, B350, W150, W250, RAMCHARGER, DAKOTA	1989/1992	44
5.2L	RAM 1500, 2500, 3500, DURANGO, GRAND CHEROKEE, B1500, 2500, 3500.	1992/2002	45
5.7L	300 C, CHALLENGER, CHARGER	2005/2012	45
5.7L	RAM 1500, 2500, 3500, DURANGO, GRAND CHEROKEE, COMANDER	2003/2009	46
5.9L	RAM 2500, 3500 CUMMINS TURBO	2003/2008	*
5.9L	RAMCHARGER, B100, B200, B300, D100, D200, D300, CORONET, DART, MONACO	1971/1980	*

* Escanear código QR para consultar en catálogo electrónico o diríjase a catalogo.dcp.com.mx.



LITROS	MODELO	AÑO	PÁGINA
LITERS	MODEL	YEAR	PAGE
5.9L	RAMCHARGER, W150, W250, W350, D250, D350, CAMION MICRO	1981/1989	46
5.9L	RAMCHARGER, D150, D250, D350, W150, W250, W350, MICROBUS	1990/1992	47
5.9L	RAM 1500, 2500, 3500, DURANGO, DAKOTA	1993/2003	47
7.2L	CHARGER, CORONET, BARRACUDA, CHALLENGER, MONACO, CORONET, FURY	1966/1978	*
8.0L	RAM 2500, 3500, VIPER,	1992/2003	*



1.0L	MOTOR	MODELOS	DESDE / A	JUNTA DE CABEZA	MULTIPLE DE ADMISIÓN O PLENO
ENGINE	MODELS	FROM / TO	HEAD GASKET	INTAKE	
4L SOHC.12 V G4HC	ATOS.	2000/2003	CA-201-G 	MS-4201 	
FS-201 			MULTIPLE DE ESCAPE EXHAUST MS-4201-E 	PUNTERIAS VALVE COVER VS-3201-R 	CARTER OIL PAN OS-1201
DISTRIBUCIÓN TIMING COVER TC-6201 	RETÉN CIGÜEÑAL CRANK SEAL BS-7201 	SELLOS DE VALVULA STEM SEALS SS-8201-PA 	JUNTAS VARIAS MISCELLANEOUS		

1.1L	MOTOR	MODELOS	DESDE / A	JUNTA DE CABEZA	MULTIPLE DE ADMISIÓN O PLENO
ENGINE	MODELS	FROM / TO	HEAD GASKET	INTAKE	
4L SOHC 12 V G4HC	ATOS.	2004/2009	CA-201-1G 	MS-4201 	
FS-201-1 			MULTIPLE DE ESCAPE EXHAUST MS-4201-E 	PUNTERIAS VALVE COVER VS-3201-1R 	CARTER OIL PAN OS-1201
DISTRIBUCIÓN TIMING COVER TC-6201 	RETÉN CIGÜEÑAL CRANK SEAL BS-7201 	SELLOS DE VALVULA STEM SEALS SS-8201-PA 	JUNTAS VARIAS MISCELLANEOUS		



1.2L	MOTOR	MODELOS	DESDE / A	JUNTA DE CABEZA	MULTIPLE DE ADMISIÓN O PLENO
ENGINE	MODELS	FROM / TO	HEAD GASKET	INTAKE	
4L, SOHC 12V	i 10.	2012/2014	CA-207-ML 	MS-4207-A 	
FS-207-ML					
DISTRIBUCIÓN	RETÉN CIGÜEÑAL	SELLOS DE VALVULA	JUNTAS VARIAS	N/A	
TIMING COVER	CRANK SEAL	STEM SEALS	MISCELLANEOUS		
TC-6201	BS-7201	SS-8201-PA	N/A		









1.4L	MOTOR	MODELOS	DESDE / A	JUNTA DE CABEZA	MULTIPLE DE ADMISIÓN O PLENO
ENGINE	MODELS	FROM / TO	HEAD GASKET	INTAKE	
4L, DOHC 16V G4EE G4KF	ATTITUDE.	2006/2011	CA-204-ML 	MS-4204 	
FS-204-ML					
DISTRIBUCIÓN	RETÉN CIGÜEÑAL	SELLOS DE VALVULA	JUNTAS VARIAS	N/A	
TIMING COVER	CRANK SEAL	STEM SEALS	MISCELLANEOUS		
TC-6204	BS-7203	SS-8252-1V	N/A		





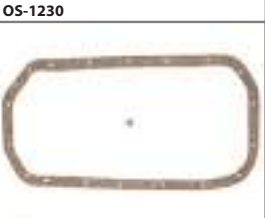

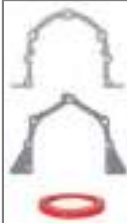



1.4L	MOTOR	MODELOS	DESDE / A	JUNTA DE CABEZA		MULTIPLE DE ADMISIÓN O PLENO
ENGINE	MODELS	FROM / TO	HEAD GASKET		INTAKE	
4L, SOHC 8V MOTOR MIT-SUBISHI G15B	COLT, MIRAGE, EXCEL.	1979/1991	CA-230-G		MS-4230	
FS-230			MULTIPLE DE ESCAPE		PUNTERIAS	CARTER
			EXHAUST		VALVE COVER	OIL PAN
			MS-4230-E	VS-3230-R	OS-1230	
DISTRIBUCIÓN		RETÉN CIGÜEÑAL	SELLOS DE VALVULA		JUNTAS VARIAS	N/A
TIMING COVER		CRANK SEAL	STEM SEALS		MISCELLANEOUS	
TC-6230		BS-7230	SS-8230-PA		N/A	



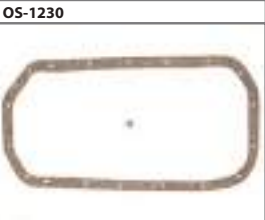

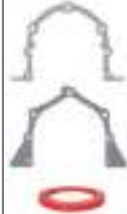

1.5L	MOTOR	MODELOS	DESDE / A	JUNTA DE CABEZA		MULTIPLE DE ADMISIÓN O PLENO
ENGINE	MODELS	FROM / TO	HEAD GASKET		INTAKE	
4L, SOHC 12V G4EK	VERNA.	2000/2006	CA-203-ML		MS-4203	
FS-203-ML			MULTIPLE DE ESCAPE		PUNTERIAS	CARTER
			EXHAUST		VALVE COVER	OIL PAN
			MS-4203-1E	VS-3203-R	OS-1203	
DISTRIBUCIÓN		RETÉN CIGÜEÑAL	SELLOS DE VALVULA		JUNTAS VARIAS	
TIMING COVER		CRANK SEAL	STEM SEALS		MISCELLANEOUS	
TC-6203-1		BS-7203	SS-8203-V (pendiente componente)			



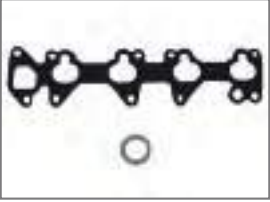



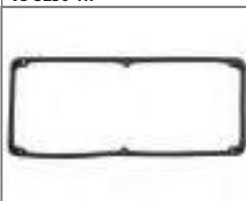
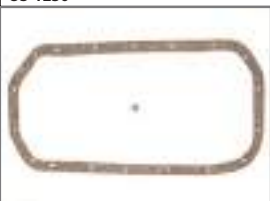

1.5L	MOTOR	MODELOS	DESDE / A	JUNTA DE CABEZA		MÚLTIPLE DE ADMISIÓN O PLENO	
ENGINE	MODELS	FROM / TO	HEAD GASKET		INTAKE		
4L, SOHC 8V MOTOR MIT-SUBISHI G15B	COLT, MIRAGE, EXCEL.	1979/1984					
			MÚLTIPLE DE ESCAPE EXHAUST 		PUNTERIAS VALVE COVER 	CARTER OIL PAN 	
DISTRIBUCIÓN TIMING COVER		RETÉN CIGÜEÑAL CRANK SEAL		SELLOS DE VALVULA STEM SEALS		JUNTAS VARIAS MISCELLANEOUS	N/A
TC-6230		BS-7230		SS-8230-PA			

1.5L	MOTOR	MODELOS	DESDE / A	JUNTA DE CABEZA		MÚLTIPLE DE ADMISIÓN O PLENO	
ENGINE	MODELS	FROM / TO	HEAD GASKET		INTAKE		
4L, SOHC 12V	COLT, MIRAGE, VISTA	1985/1990					
			MÚLTIPLE DE ESCAPE EXHAUST 		PUNTERIAS VALVE COVER 	CARTER OIL PAN 	
DISTRIBUCIÓN TIMING COVER		RETÉN CIGÜEÑAL CRANK SEAL		SELLOS DE VALVULA STEM SEALS		JUNTAS VARIAS MISCELLANEOUS	
TC-6230		BS-7230		SS-8230-PA			

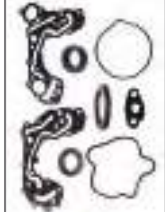

1.5L	MOTOR	MODELOS	DESDE / A	JUNTA DE CABEZA		MULTIPLE DE ADMISIÓN O PLENO	
ENGINE	MODELS	FROM / TO	HEAD GASKET		INTAKE		
4L, SOHC 12V MOTOR MITSUBISHI G15B	COLT, MIRAGE, VISTA	1991/1996	CA-230-G 		MS-4230-2 		
FS-230-2							
DISTRIBUCIÓN		RETÉN CIGÜEÑAL		SELLOS DE VALVULA		JUNTAS VARIAS	
TIMING COVER		CRANK SEAL		STEM SEALS		MISCELLANEOUS	
TC-6230 		BS-7230 		SS-8230-PA 		N/A	
				MULTIPLE DE ESCAPE		PUNTERIAS	
				EXHAUST		VALVE COVER	
				MS-4230-1E 		VS-3230-1R 	
						OS-1230 	

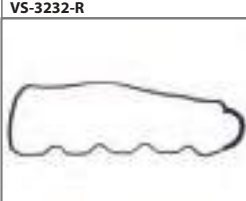
1.8L	MOTOR	MODELOS	DESDE / A	JUNTA DE CABEZA		MULTIPLE DE ADMISIÓN O PLENO	
ENGINE	MODELS	FROM / TO	HEAD GASKET		INTAKE		
4L, SOHC 8V MOTOR MITSUBISHI 4G37 VIN T	ECLIPSE, TALON, COLT, LASER.	1989/1994	CA-237-G 		MS-4231 		
FS-237							
DISTRIBUCIÓN		RETÉN CIGÜEÑAL		SELLOS DE VALVULA		JUNTAS VARIAS	
TIMING COVER		CRANK SEAL		STEM SEALS		MISCELLANEOUS	
TC-6237-1 		BS-7237 		SS-8250-V 		N/A	
				MULTIPLE DE ESCAPE		PUNTERIAS	
				EXHAUST		VALVE COVER	
				MS-4237-1E 		VS-3232-R 	
						** N/A ** N/A	



2.0L	MOTOR	MODELOS	DESDE / A	JUNTA DE CABEZA		MÚLTIPLE DE ADMISIÓN O PLENO
ENGINE	MODELS	FROM / TO	HEAD GASKET		INTAKE	
4L, SOHC 8V MOTOR MIT-SUBISHI G63B 4G63 VIN V	COLT, VISTA, GALANT, 2000GTX, STELLAR.	1984/1990	CA-235-G		MS-4235	
FS-235						
DISTRIBUCIÓN		RETÉN CIGÜEÑAL	SELLOS DE VALVULA	JUNTAS VARIAS	N/A	
TIMING COVER		CRANK SEAL	STEM SEALS	MISCELLANEOUS		
TC-6235	BS-7235	SS-8230-PA	N/A			

2.0L	MOTOR	MODELOS	DESDE / A	JUNTA DE CABEZA		MÚLTIPLE DE ADMISIÓN O PLENO
ENGINE	MODELS	FROM / TO	HEAD GASKET		INTAKE	
4L, DOHC 16V MOTOR MIT-SUBISHI 4G63T VIN R U	ECLIPSE, GALANT, 2000 GTX, TALON.	1990/1994	CA-235-1G		MS-4235-1	
FS-235-1						
DISTRIBUCIÓN		RETÉN CIGÜEÑAL	SELLOS DE VALVULA	JUNTAS VARIAS		
TIMING COVER		CRANK SEAL	STEM SEALS	MISCELLANEOUS		
TC-6235	BS-7250	SS-8230-PA	235.1			



2.0L	MOTOR	MODELOS	DESDE / A	JUNTA DE CABEZA	MULTIPLE DE ADMISIÓN O PLENO
ENGINE	MODELS	FROM / TO	HEAD GASKET	INTAKE	
4L, DOHC 16V MOTOR MITSUBISHI 4G63T VIN F	ECLIPSE, EAGLE TALON	1993/1999	CA-235-G 		
FS-236 			MULTIPLE DE ESCAPE EXHAUST	PUNTERIAS VALVE COVER	CARTER OIL PAN
			MS-4235-1E 	VS-3235-2R 	N/A
DISTRIBUCIÓN TIMING COVER	RETÉN CIGÜEÑAL CRANK SEAL		SELLOS DE VALVULA STEM SEALS	JUNTAS VARIAS MISCELLANEOUS	N/A
TC-6235-2 	BS-7205 		SS-8235 	N/A	

2.0L	MOTOR	MODELOS	DESDE / A	JUNTA DE CABEZA	MULTIPLE DE ADMISIÓN O PLENO
ENGINE	MODELS	FROM / TO	HEAD GASKET	INTAKE	
4L, SOHC 16V VIN C	NEON.	1996/1999	CA-242-G 	MS-4243-1 	
FS-242-1 			MULTIPLE DE ESCAPE EXHAUST	PUNTERIAS VALVE COVER	CARTER OIL PAN
			MS-4243-E 	VS-3243-1R 	OS-1242-HD
DISTRIBUCIÓN TIMING COVER	RETÉN CIGÜEÑAL CRANK SEAL		SELLOS DE VALVULA STEM SEALS	JUNTAS VARIAS MISCELLANEOUS	
TC-6242-2 	BS-7240 		SS-8242-V 		



2.0L	MOTOR	MODELOS	DESDE / A	JUNTA DE CABEZA		MÚLTIPLE DE ADMISIÓN O PLENO	
ENGINE	MODELS	FROM / TO	HEAD GASKET		INTAKE		
4L, SOHC 16V VIN C, F	NEON, CIRRUS, STRATUS	1999/2005	CA-242-G		MS-4243-1		
FS-243-1							
			MÚLTIPLE DE ESCAPE	PUNTERIAS	CARTER		
			EXHAUST	VALVE COVER	OIL PAN		
			MS-4243-E	VS-3243-2R	OS-1242-HD		
DISTRIBUCIÓN		RETÉN CIGÜEÑAL		SELLOS DE VALVULA		JUNTAS VARIAS	
TIMING COVER		CRANK SEAL		STEM SEALS		MISCELLANEOUS	
TC-6242-1		BS-7240		SS-8242-V			

2.2L	MOTOR	MODELOS	DESDE / A	JUNTA DE CABEZA		MÚLTIPLE DE ADMISIÓN O PLENO	
ENGINE	MODELS	FROM / TO	HEAD GASKET		INTAKE		
4L, SOHC 8V VIN K C D EXCEPTO TURBO	VOYAGER, DART K, SHADOW, SPIRIT, DAYTONA, LeBARON.	1981/1988	CA-240-G		MS-4240		
FS-240							
			MÚLTIPLE DE ESCAPE	PUNTERIAS	CARTER		
			EXHAUST	VALVE COVER	OIL PAN		
			N/A	VS-3240	OS-1240		
			N/A				
DISTRIBUCIÓN		RETÉN CIGÜEÑAL		SELLOS DE VALVULA		JUNTAS VARIAS	
TIMING COVER		CRANK SEAL		STEM SEALS		MISCELLANEOUS	
TC-6240		BS-7240		SS-8240-S			



2.2L	MOTOR	MODELOS	DESDE / A	JUNTA DE CABEZA	MULTIPLE DE ADMISIÓN O PLENO
ENGINE	MODELS	FROM / TO	HEAD GASKET	INTAKE	
4L, SOHC 8V MOTOR TURBO	SHADOW, DART K, LeBARON, TOWN & COUNTRY, LANCER	1983/1990	CA-240-G 	MS-4240 	
FS-240-1 			MULTIPLE DE ESCAPE EXHAUST ** N/A ** N/A	PUNTERIAS VALVE COVER VS-3240-1 	CARTER OIL PAN OS-1240-1C
DISTRIBUCIÓN TIMING COVER TC-6240-1 	RETÉN CIGÜEÑAL CRANK SEAL BS-7240 	SELLOS DE VALVULA STEM SEALS SS-8240-S 	JUNTAS VARIAS MISCELLANEOUS 		

2.2L	MOTOR	MODELOS	DESDE / A	JUNTA DE CABEZA	MULTIPLE DE ADMISIÓN O PLENO
ENGINE	MODELS	FROM / TO	HEAD GASKET	INTAKE	
4L, SOHC 8V MOTOR TURBO CARTER Y PUNTERIA SILICON	SHADOW, VOYAGER, SPIRIT, DAKOTA, PHANTOM, LeBARON	1990/1995	CA-240-G 	MS-4240 	
FS-240-2 			MULTIPLE DE ESCAPE EXHAUST ** N/A ** N/A	PUNTERIAS VALVE COVER VS-3240-2R 	CARTER OIL PAN OS-1240-1R
DISTRIBUCIÓN TIMING COVER TC-6240-2 	RETÉN CIGÜEÑAL CRANK SEAL BS-7240 	SELLOS DE VALVULA STEM SEALS SS-8240-S 	JUNTAS VARIAS MISCELLANEOUS 		



2.4L	MOTOR	MODELOS	DESDE / A	JUNTA DE CABEZA	MULTIPLE DE ADMISIÓN O PLENO
ENGINE	MODELS	FROM / TO	HEAD GASKET	INTAKE	
4L, SOHC 8V G64B 464B	H-100.	2003/2005	CA-202-G 	MS-4235 	
FS-202 			MULTIPLE DE ESCAPE EXHAUST MS-4235-E 	PUNTERIAS VALVE COVER VS-3235-R 	CARTER OIL PAN OS-1235
DISTRIBUCIÓN TIMING COVER TC-6235 	RETÉN CIGÜEÑAL CRANK SEAL BS-7250 	SELLOS DE VALVULA STEM SEALS SS-8250-N 	JUNTAS VARIAS MISCELLANEOUS 		

2.4L	MOTOR	MODELOS	DESDE / A	JUNTA DE CABEZA	MULTIPLE DE ADMISIÓN O PLENO
ENGINE	MODELS	FROM / TO	HEAD GASKET	INTAKE	
4L, DOHC 16V MOTOR GEMA VIN W, K	PATRIOT, JOURNEY, COMPASS, CALIBER, AVENGER (CABEZA EN GRAFITO).	2007/2013	CA-226-G 	MS-4226-A 	
FS-226-G 			MULTIPLE DE ESCAPE EXHAUST MS-4226-E 	PUNTERIAS VALVE COVER VS-3226-R 	CARTER OIL PAN
DISTRIBUCIÓN TIMING COVER TC-6226 	RETÉN CIGÜEÑAL CRANK SEAL BS-7226 	SELLOS DE VALVULA STEM SEALS SS-8226-V 	JUNTAS VARIAS MISCELLANEOUS N/A		N/A



2.4L	MOTOR	MODELOS	DESDE / A	JUNTA DE CABEZA	MULTIPLE DE ADMISIÓN O PLENO
ENGINE	MODELS	FROM / TO	HEAD GASKET	INTAKE	
4L, DOHC 16V MOTOR GEMA VIN W, B	PATRIOT, JOURNEY, COMPASS, CALIBER, AVENGER (CABEZA EN MLS).	2007/2013	CA-226-ML 	MS-4226-A 	
FS-226-ML 			MULTIPLE DE ESCAPE EXHAUST	PUNTERIAS VALVE COVER	CARTER OIL PAN
			MS-4226-E 	VS-3226-R 	
DISTRIBUCIÓN TIMING COVER	RETÉN CIGÜEÑAL CRANK SEAL	SELLOS DE VALVULA STEM SEALS	JUNTAS VARIAS MISCELLANEOUS	N/A	
TC-6226 	BS-7226 	SS-8226-V 	N/A		

2.4L	MOTOR	MODELOS	DESDE / A	JUNTA DE CABEZA	MULTIPLE DE ADMISIÓN O PLENO
ENGINE	MODELS	FROM / TO	HEAD GASKET	INTAKE	
4L, DOHC 16V VIN X, B	STRATUS, CIRRUS, VOYAGER, SEBRING.	1995/2000	CA-245-G 	MS-4242 	
FS-245 			MULTIPLE DE ESCAPE EXHAUST	PUNTERIAS VALVE COVER	CARTER OIL PAN
			MS-4242-E 	VS-3242-1R 	OS-1245-HD
DISTRIBUCIÓN TIMING COVER	RETÉN CIGÜEÑAL CRANK SEAL	SELLOS DE VALVULA STEM SEALS	JUNTAS VARIAS MISCELLANEOUS	N/A	
TC-6242-1 	BS-7240 	SS-8242-V 	N/A		



2.4L	MOTOR	MODELOS	DESDE / A	JUNTA DE CABEZA	MULTIPLE DE ADMISIÓN O PLENO
ENGINE	MODELS	FROM / TO	HEAD GASKET	INTAKE	
4L, DOHC 16V VIN X, B	PT CRUISER (CABEZA EN MLS).	2002/2007	CA-245-1ML 	MS-4245-1 	
FS-245-1ML 			MULTIPLE DE ESCAPE EXHAUST MS-4245-1E 	PUNTERIAS VALVE COVER VS-3245-R 	CARTER OIL PAN OS-1245-2
DISTRIBUCIÓN TIMING COVER TC-6242-1 	RETÉN CIGÜEÑAL CRANK SEAL BS-7240 	SELLOS DE VALVULA STEM SEALS SS-8242-V 	JUNTAS VARIAS MISCELLANEOUS N/A	N/A	

2.4L	MOTOR	MODELOS	DESDE / A	JUNTA DE CABEZA	MULTIPLE DE ADMISIÓN O PLENO
ENGINE	MODELS	FROM / TO	HEAD GASKET	INTAKE	
4L, DOHC 16V VIN X, B	PT CRUISER (CABEZA EN GRAFITO).	2002/2007	CA-245-1G 	MS-4245-1 	
FS-245-1 			MULTIPLE DE ESCAPE EXHAUST MS-4245-1E 	PUNTERIAS VALVE COVER VS-3245-R 	CARTER OIL PAN OS-1245-2
DISTRIBUCIÓN TIMING COVER TC-6242-1 	RETÉN CIGÜEÑAL CRANK SEAL BS-7240 	SELLOS DE VALVULA STEM SEALS SS-8242-V 	JUNTAS VARIAS MISCELLANEOUS N/A	N/A	



2.4L	MOTOR	MODELOS	DESDE / A	JUNTA DE CABEZA	MULTIPLE DE ADMISIÓN O PLENO
ENGINE	MODELS	FROM / TO	HEAD GASKET	INTAKE	
4L, SOHC 16V MOTOR MITSUBISHI 4G69	ECLIPSE, GALANT, OUTLANDER, LANCER.	2005/2009	CA-247-ML 	MS-4247-A 	
FS-247-ML 			MULTIPLE DE ESCAPE EXHAUST	PUNTERIAS VALVE COVER	CARTER OIL PAN
				VS-3247-R 	OS-1251-1
DISTRIBUCIÓN TIMING COVER	RETÉN CIGÜEÑAL CRANK SEAL	SELLOS DE VALVULA STEM SEALS	JUNTAS VARIAS MISCELLANEOUS	N/A	
TC-6247 	BS-7226 	SS-8109-S 	N/A		

2.5L	MOTOR	MODELOS	DESDE / A	JUNTA DE CABEZA	MULTIPLE DE ADMISIÓN O PLENO
ENGINE	MODELS	FROM / TO	HEAD GASKET	INTAKE	
4L, SOHC 8V TDI MOTOR MITSUBISHI 4D56T	H-100.	2005/2009	CA-206-D 	MS-4206-D 	
FS-206-D 			MULTIPLE DE ESCAPE EXHAUST	PUNTERIAS VALVE COVER	CARTER OIL PAN
			** N/A **	VS-3206-RD 	OS-1250
DISTRIBUCIÓN TIMING COVER	RETÉN CIGÜEÑAL CRANK SEAL	SELLOS DE VALVULA STEM SEALS	JUNTAS VARIAS MISCELLANEOUS	N/A	
TC-6206-D 	BS-7206-D 	SS-8250-N 	N/A		



2.5L	MOTOR	MODELOS	DESDE / A	JUNTA DE CABEZA	MULTIPLE DE ADMISIÓN O PLENO
ENGINE	MODELS	FROM / TO	HEAD GASKET	INTAKE	
4L, SOHC 8V VIN K C D EXCEPTO TURBO	VOYAGER, DART K, SHADOW, SPIRIT, DAYTONA, LeBARON.	1981/1988	CA-240-G 	MS-4240 	
FS-240 			MULTIPLE DE ESCAPE EXHAUST ** N/A ** N/A	PUNTERIAS VALVE COVER VS-3240 	CARTER OIL PAN OS-1240
DISTRIBUCIÓN TIMING COVER TC-6240 	RETÉN CIGÜEÑAL CRANK SEAL BS-7240 	SELLOS DE VALVULA STEM SEALS SS-8240-S 	JUNTAS VARIAS MISCELLANEOUS		

2.5L	MOTOR	MODELOS	DESDE / A	JUNTA DE CABEZA	MULTIPLE DE ADMISIÓN O PLENO
ENGINE	MODELS	FROM / TO	HEAD GASKET	INTAKE	
4L, SOHC 8V MOTOR TURBO	SHADOW, DART K, LeBARON, TOWN & COUNTRY, LANCER	1983/1990	CA-240-G 	MS-4240 	
FS-240-1 			MULTIPLE DE ESCAPE EXHAUST ** N/A ** N/A	PUNTERIAS VALVE COVER VS-3240-1 	CARTER OIL PAN OS-1240-1C
DISTRIBUCIÓN TIMING COVER TC-6240-1 	RETÉN CIGÜEÑAL CRANK SEAL BS-7240 	SELLOS DE VALVULA STEM SEALS SS-8240-S 	JUNTAS VARIAS MISCELLANEOUS 		



2.5L	MOTOR	MODELOS	DESDE / A	JUNTA DE CABEZA	MULTIPLE DE ADMISIÓN O PLENO
ENGINE	MODELS	FROM / TO	HEAD GASKET	INTAKE	
4L, SOHC 8V MOTOR TURBO CARTER Y PUNTERIA SILICON	SHADOW, VOYAGER, SPIRIT, DAKOTA, PHANTOM, LeBARON	1990/1995	CA-240-G 	MS-4240 	
FS-240-2					
DISTRIBUCIÓN			MULTIPLE DE ESCAPE		
TIMING COVER			EXHAUST		
TC-6240-2 			** N/A ** N/A		
RETÉN CIGÜEÑAL			PUNTERIAS		
CRANK SEAL			VALVE COVER		
BS-7240 			VS-3240-2R 		
SELLOS DE VALVULA			CARTER		
STEM SEALS			OIL PAN		
SS-8240-S 			OS-1240-1R 		
JUNTAS VARIAS			MISCELLANEOUS		

2.5L	MOTOR	MODELOS	DESDE / A	JUNTA DE CABEZA	MULTIPLE DE ADMISIÓN O PLENO
ENGINE	MODELS	FROM / TO	HEAD GASKET	INTAKE	
V6, SOHC 24V MOTOR MITSUBISHI 6G73 VIN H	STRATUS, CIRRUS, SEBRING (CABEZAS DE GRAFITO).	1995/2000	CA-252-G 	MS-4252 	
FS-252					
DISTRIBUCIÓN			MULTIPLE DE ESCAPE		
TIMING COVER			EXHAUST		
TC-6252 			MS-4252-E 		
RETÉN CIGÜEÑAL			PUNTERIAS		
CRANK SEAL			VALVE COVER		
BS-7240 			VS-3252-R 		
SELLOS DE VALVULA			CARTER		
STEM SEALS			OIL PAN		
SS-8252-S 			OS-1252 		
JUNTAS VARIAS			MISCELLANEOUS		



2.6L	MOTOR	MODELOS	DESDE / A	JUNTA DE CABEZA		MÚLTIPLE DE ADMISIÓN O PLENO
ENGINE	MODELS	FROM / TO	HEAD GASKET		INTAKE	
4L, SOHC 8V MOTOR G54B VIN G, E	CARAVAN, VOYAGER, LeBARON, RAM 50.	1981/1989	CA-250-G		MS-4250	
FS-250			MÚLTIPLE DE ESCAPE	PUNTERIAS	CARTER	
			EXHAUST	VALVE COVER	OIL PAN	
			MS-4250-E	VS-3250-R	OS-1250	
DISTRIBUCIÓN	RETÉN CIGÜEÑAL	SELLOS DE VALVULA	JUNTAS VARIAS	N/A		
TIMING COVER	CRANK SEAL	STEM SEALS	MISCELLANEOUS			
TC-6250	BS-7250	SS-8250-1N	N/A			









2.7L	MOTOR	MODELOS	DESDE / A	JUNTA DE CABEZA		MÚLTIPLE DE ADMISIÓN O PLENO
ENGINE	MODELS	FROM / TO	HEAD GASKET		INTAKE	
V6, DOHC 24V VIN R	INTREPID, CONCORDE.	1998/2000	CA-280-ML Y CA-281-ML		MS-4280	
			<p>PARA VER IMAGEN DIRIGIRSE A SECCIÓN DE JUNTAS DE CABEZA.</p> <p>TO SEE IMAGE GO TO SECTION HEAD GASKETS</p>			
FS-280			MÚLTIPLE DE ESCAPE	PUNTERIAS	CARTER	
			EXHAUST	VALVE COVER	OIL PAN	
			MS-4280-E	VS-3280-R	OS-1280-R	
DISTRIBUCIÓN	RETÉN CIGÜEÑAL	SELLOS DE VALVULA	JUNTAS VARIAS	N/A		
TIMING COVER	CRANK SEAL	STEM SEALS	MISCELLANEOUS			
TC-6280	BS-7240	SS-8280-V	N/A			

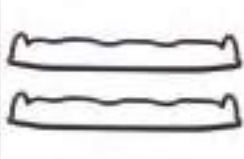

2.7L	MOTOR	MODELOS	DESDE / A	JUNTA DE CABEZA	MULTIPLE DE ADMISIÓN O PLENO
ENGINE	MODELS	FROM / TO	HEAD GASKET	INTAKE	
V6, DOHC 24V VIN R, D, T, U	INTREPID, CONCORDE, SEBRING, CIRRUS	2001/2010	CA-280-ML Y CA-281-ML	MS-4280	
<p>PARA VER IMAGEN DIRIGIRSE A SECCIÓN DE JUNTAS DE CABEZA.</p> <p>TO SEE IMAGE GO TO SECTION HEAD GASKETS</p>					
<p>FS-280-1</p>			<p>MULTIPLE DE ESCAPE</p> <p>EXHAUST</p> <p>MS-4280-E</p>	<p>PUNTERIAS</p> <p>VALVE COVER</p> <p>VS-3280-1R</p>	<p>CARTER</p> <p>OIL PAN</p> <p>OS-1280-R</p>
<p>DISTRIBUCIÓN</p> <p>TIMING COVER</p> <p>TC-6280</p>	<p>RETÉN CIGÜEÑAL</p> <p>CRANK SEAL</p> <p>BS-7240</p>	<p>SELLOS DE VALVULA</p> <p>STEM SEALS</p> <p>SS-8280-V</p>	<p>JUNTAS VARIAS</p> <p>MISCELLANEOUS</p> <p>N/A</p>	N/A	

3.0L	MOTOR	MODELOS	DESDE / A	JUNTA DE CABEZA	MULTIPLE DE ADMISIÓN O PLENO
ENGINE	MODELS	FROM / TO	HEAD GASKET	INTAKE	
V6, SOHC 12V MOTOR MITSUBISHI 6G72 MULT. ESCAPE S/DEFLECTOR	CARAVAN, VOYAGER, LeBARON, DYNASTY.	1987/1995	CA-253-G	MS-4253	
<p>FS-253</p>			<p>MULTIPLE DE ESCAPE</p> <p>EXHAUST</p> <p>MS-4253-3E</p>	<p>PUNTERIAS</p> <p>VALVE COVER</p> <p>VS-3253-R</p>	<p>CARTER</p> <p>OIL PAN</p> <p>OS-1253</p>
<p>DISTRIBUCIÓN</p> <p>TIMING COVER</p> <p>TC-6253</p>	<p>RETÉN CIGÜEÑAL</p> <p>CRANK SEAL</p> <p>BS-7253</p>	<p>SELLOS DE VALVULA</p> <p>STEM SEALS</p> <p>SS-8253</p>	<p>JUNTAS VARIAS</p> <p>MISCELLANEOUS</p> <p>N/A</p>	N/A	

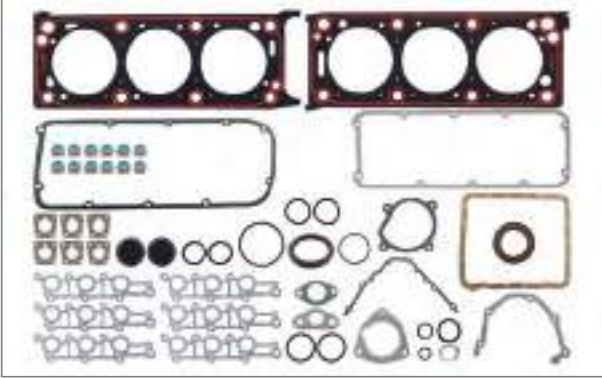

3.0L	MOTOR	MODELOS	DESDE / A	JUNTA DE CABEZA	MULTIPLE DE ADMISIÓN O PLENO		
ENGINE	MODELS	FROM / TO	HEAD GASKET	INTAKE			
V6, SOHC 12V MOTOR MITSUBISHI 6G72 MULT. ESCAPE C/DEFLECTOR	GRAND CARAVAN, SHADOW, SPIRIT, GRAND VOYAGER, LeBARON,	1987/1995	CA-253-G 	MS-4253 			
FS-253-1 			MULTIPLE DE ESCAPE EXHAUST	PUNTERIAS VALVE COVER	CARTER OIL PAN		
			MS-4253-2E 	VS-3253-R 	OS-1253 		
DISTRIBUCIÓN TIMING COVER		RETÉN CIGÜEÑAL CRANK SEAL		SELLOS DE VALVULA STEM SEALS		JUNTAS VARIAS MISCELLANEOUS	N/A
TC-6253		BS-7253		SS-8253			

3.0L	MOTOR	MODELOS	DESDE / A	JUNTA DE CABEZA	MULTIPLE DE ADMISIÓN O PLENO		
ENGINE	MODELS	FROM / TO	HEAD GASKET	INTAKE			
V6, OHV 12V VIN V	MONACO, EAGLE PREMIER	1990/1992	** N/A ** N/A				
FS-285 			MULTIPLE DE ESCAPE EXHAUST	PUNTERIAS VALVE COVER	CARTER OIL PAN		
			** N/A ** N/A	** N/A ** N/A			
DISTRIBUCIÓN TIMING COVER	N/A	RETÉN CIGÜEÑAL CRANK SEAL	N/A	SELLOS DE VALVULA STEM SEALS	N/A	JUNTAS VARIAS MISCELLANEOUS	
** N/A **		** N/A **		** N/A **			



3.3L	MOTOR	MODELOS	DESDE / A	JUNTA DE CABEZA	MULTIPLE DE ADMISIÓN O PLENO
ENGINE	MODELS	FROM / TO	HEAD GASKET	INTAKE	
V6, OHV 12V NO INCLUYE CONCHA DE ADMISION	GRAND CARAVAN, GRAND VOYAGER.	1990/2000	CA-254-G Y CA-255-G	MS-4254-A	
FS-254 			<p>PARA VER IMAGEN DIRIGIRSE A SECCIÓN DE JUNTAS DE CABEZA.</p> <p>TO SEE IMAGE GO TO SECTION HEAD GASKETS</p>		
DISTRIBUCIÓN		RETÉN CIGÜEÑAL	SELLOS DE VALVULA	JUNTAS VARIAS	N/A
TIMING COVER		CRANK SEAL	STEM SEALS	MISCELLANEOUS	
TC-6254		BS-7240-1	SS-8240-S		N/A

3.5L	MOTOR	MODELOS	DESDE / A	JUNTA DE CABEZA	MULTIPLE DE ADMISIÓN O PLENO
ENGINE	MODELS	FROM / TO	HEAD GASKET	INTAKE	
V6, SOHC 24V VIN F	INTREPID, CONCORDE, NEW YORKER.	1993/1997	CA-261-G	MS-4261	
FS-261 			<p>MULTIPLE DE ESCAPE</p> <p>PUNTERIAS</p> <p>EXHAUST</p> <p>VALVE COVER</p> <p>MS-4262-E</p> <p>VS-3261-HD</p> <p>OS-1261-R</p>		
DISTRIBUCIÓN		RETÉN CIGÜEÑAL	SELLOS DE VALVULA	JUNTAS VARIAS	N/A
TIMING COVER		CRANK SEAL	STEM SEALS	MISCELLANEOUS	
TC-6261		BS-7253	SV-8262-V		N/A



3.5L	MOTOR	MODELOS	DESDE / A	JUNTA DE CABEZA	MULTIPLE DE ADMISIÓN O PLENO
ENGINE	MODELS	FROM / TO	HEAD GASKET	INTAKE	
V6, SOHC 24V	JOURNEY, AVENGER, SEBRING, CHARGER, CHALLENGER, MODELO 300.	2007/2010	<p>CA-268-ML Y CA-268-1ML</p> <p>PARA VER IMAGEN DIRIGIRSE A SECCIÓN DE JUNTAS DE CABEZA.</p> <p>TO SEE IMAGE GO TO SECTION HEAD GASKETS</p>	MS-4261-3LS	
FS-268-ML					
DISTRIBUCIÓN		RETÉN CIGÜEÑAL	SELLOS DE VALVULA	JUNTAS VARIAS	N/A
TIMING COVER		CRANK SEAL	STEM SEALS	MISCELLANEOUS	
TC-6268		BS-7268-LT			







3.6L	MOTOR	MODELOS	DESDE / A	JUNTA DE CABEZA	MULTIPLE DE ADMISIÓN O PLENO
ENGINE	MODELS	FROM / TO	HEAD GASKET	INTAKE	
V6, DOHC 24V MOTOR PENTASTAR VIN G	TOWN & COUNTRY, CARAVAN, AVENGER, JOURNEY, CHALLENGER, RAM 1500, 200.	2011/2013	<p>CA-269-ML Y CA-269-1ML</p> <p>PARA VER IMAGEN DIRIGIRSE A SECCIÓN DE JUNTAS DE CABEZA.</p> <p>TO SEE IMAGE GO TO SECTION HEAD GASKETS</p>	MS-4269	
FS-269-ML					
DISTRIBUCIÓN		RETÉN CIGÜEÑAL	SELLOS DE VALVULA	JUNTAS VARIAS	N/A
TIMING COVER		CRANK SEAL	STEM SEALS	MISCELLANEOUS	
				N/A	



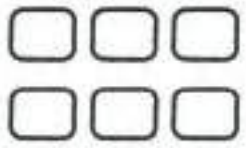





3.7L	MOTOR	MODELOS	DESDE / A	JUNTA DE CABEZA	MULTIPLE DE ADMISIÓN O PLENO
ENGINE	MODELS	FROM / TO	HEAD GASKET	INTAKE	
L6, OHV 12V MOTOR 225"	D-150, D-250, B150, B250	1981/1991	CA-225-G 	MS-4220 	
FS-225-1 			MULTIPLE DE ESCAPE EXHAUST ** N/A ** N/A	PUNTERIAS VALVE COVER VS-3225 	CARTER OIL PAN OS-1220
DISTRIBUCIÓN TIMING COVER TC-6220 	RETÉN CIGÜEÑAL CRANK SEAL BS-7220-R 	SELLOS DE VALVULA STEM SEALS SS-8220-A 	JUNTAS VARIAS MISCELLANEOUS 		

3.7L	MOTOR	MODELOS	DESDE / A	JUNTA DE CABEZA	MULTIPLE DE ADMISIÓN O PLENO
ENGINE	MODELS	FROM / TO	HEAD GASKET	INTAKE	
V6, SOHC 12V VIN K CABEZA DE GRAFITO	DAKOTA, RAM 1500, JEEP LIBERTY (CABEZA EN GRAFITO).	2002/2005	CA-271-G 	MS-4271 	
FS-271 			MULTIPLE DE ESCAPE EXHAUST MS-4271-E 	PUNTERIAS VALVE COVER VS-3271-R 	CARTER OIL PAN OS-1271-R
DISTRIBUCIÓN TIMING COVER TC-6271 	RETÉN CIGÜEÑAL CRANK SEAL BS-7271 	SELLOS DE VALVULA STEM SEALS SS-8271-12V 	JUNTAS VARIAS MISCELLANEOUS 		



3.7L	MOTOR	MODELOS	DESDE / A	JUNTA DE CABEZA		MÚLTIPLE DE ADMISIÓN O PLENO
ENGINE	MODELS	FROM / TO	HEAD GASKET		INTAKE	
V6, SOHC 12V VIN K CABEZA DE MLS	DAKOTA, RAM 1500, JEEP LIBERTY (CABEZA EN MLS).	2002/2005	CA-271-ML 		MS-4271 	
FS-271-ML 						
DISTRIBUCIÓN		RETÉN CIGÜEÑAL	SELLOS DE VALVULA		JUNTAS VARIAS	
TIMING COVER		CRANK SEAL	STEM SEALS		MISCELLANEOUS	
TC-6271		BS-7271 	SS-8271-12V 			

3.7L	MOTOR	MODELOS	DESDE / A	JUNTA DE CABEZA		MÚLTIPLE DE ADMISIÓN O PLENO
ENGINE	MODELS	FROM / TO	HEAD GASKET		INTAKE	
V6, SOHC 12V VIN K	DAKOTA, RAM 1500, NITRO	2006/2012	CA-271-ML 		MS-4271 	
FS-271-1ML 						
DISTRIBUCIÓN		RETÉN CIGÜEÑAL	SELLOS DE VALVULA		JUNTAS VARIAS	
TIMING COVER		CRANK SEAL	STEM SEALS		MISCELLANEOUS	
TC-6271-2		BS-7271 	SS-8271-12V 			



3.8L	MOTOR	MODELOS	DESDE / A	JUNTA DE CABEZA	MULTIPLE DE ADMISIÓN O PLENO
ENGINE	MODELS	FROM / TO	HEAD GASKET	INTAKE	
V6, OHV 12V VIN P, L NO INCLUYE VALLE DE ADMISION	TOWN & COUNTRY, GRAND CARAVAN, GRAND VOYAGER (CARTER Y PUNTERIAS DE SILICON).	1994/2001	CA-263-G Y CA-264-G	MS-4254-A	
FS-254-1G 			<p>PARA VER IMAGEN DIRIGIRSE A SECCIÓN DE JUNTAS DE CABEZA.</p> <p>TO SEE IMAGE GO TO SECTION HEAD GASKETS</p>		
DISTRIBUCIÓN TIMING COVER TC-6254 		RETÉN CIGÜEÑAL CRANK SEAL BS-7240-1 	SELLOS DE VALVULA STEM SEALS SS-8240-1V 	JUNTAS VARIAS MISCELLANEOUS N/A	N/A

3.8L	MOTOR	MODELOS	DESDE / A	JUNTA DE CABEZA	MULTIPLE DE ADMISIÓN O PLENO
ENGINE	MODELS	FROM / TO	HEAD GASKET	INTAKE	
V6, OHV 12V VIN L NO INCLUYE ADMISION	TOWN & COUNTRY, CARAVAN, VOYAGER (CARTER Y PUNTERIAS DE CORCHO).	1998/2001	CA-263-G	MS-4254-A	
FS-263 					
DISTRIBUCIÓN TIMING COVER TC-6254 		RETÉN CIGÜEÑAL CRANK SEAL BS-7253 	SELLOS DE VALVULA STEM SEALS SS-8240-S 	JUNTAS VARIAS MISCELLANEOUS N/A	N/A



3.9L	MOTOR	MODELOS	DESDE / A	JUNTA DE CABEZA		MÚLTIPLE DE ADMISIÓN O PLENO
ENGINE	MODELS	FROM / TO	HEAD GASKET		INTAKE	
V6, OHV 12V VIN X	DAKOTA AMERICANAS, B150, B250	1987/1989	CA-265-G		MS-4265	
DISTRIBUCIÓN		RETÉN CIGÜEÑAL	SELLOS DE VALVULA		JUNTAS VARIAS	N/A
TIMING COVER		CRANK SEAL	STEM SEALS		MISCELLANEOUS	
TC-6256	BS-7275-R	SS-8260-1			N/A	
					OS-1265	

3.9L	MOTOR	MODELOS	DESDE / A	JUNTA DE CABEZA		MÚLTIPLE DE ADMISIÓN O PLENO
ENGINE	MODELS	FROM / TO	HEAD GASKET		INTAKE	
V6, OHV 12V VIN X	RAM VAN, W150, D150, D250, DAKOTA	1990/1991	CA-265-G		MS-4265	
DISTRIBUCIÓN		RETÉN CIGÜEÑAL	SELLOS DE VALVULA		JUNTAS VARIAS	N/A
TIMING COVER		CRANK SEAL	STEM SEALS		MISCELLANEOUS	
TC-6256	BS-7260	SS-8261-1V			N/A	
					OS-1265	



3.9L	MOTOR	MODELOS	DESDE / A	JUNTA DE CABEZA	MULTIPLE DE ADMISIÓN O PLENO
ENGINE	MODELS	FROM / TO	HEAD GASKET	INTAKE	
V6, OHV 12V VIN X MOTOR MAGNUM	DAKOTA, RAM 1500, RAM VAN.	1992/2001	CA-270-G 	MS-4270 	
FS-270 			MULTIPLE DE ESCAPE EXHAUST	PUNTERIAS VALVE COVER	CARTER OIL PAN
DISTRIBUCIÓN TIMING COVER	RETÉN CIGÜEÑAL CRANK SEAL	SELLOS DE VALVULA STEM SEALS	JUNTAS VARIAS MISCELLANEOUS	N/A	
TC-6270 	BS-7270-R 	SS-8270-V 	N/A 		

4.7L	MOTOR	MODELOS	DESDE / A	JUNTA DE CABEZA	MULTIPLE DE ADMISIÓN O PLENO
ENGINE	MODELS	FROM / TO	HEAD GASKET	INTAKE	
V8, SOHC 16V VIN J, P, N MOTOR POWER TECH CABEZA DE GRAFITO	RAM 1500, 2500, GRAND CHE-ROKEE, DURANGO, DAKOTA (CABEZA EN GRAFITO).	1999/2005	CA-272-G 	MS-4272 	
FS-272 			MULTIPLE DE ESCAPE EXHAUST	PUNTERIAS VALVE COVER	CARTER OIL PAN
DISTRIBUCIÓN TIMING COVER	RETÉN CIGÜEÑAL CRANK SEAL	SELLOS DE VALVULA STEM SEALS	JUNTAS VARIAS MISCELLANEOUS	N/A	
TC-6271 	BS-7271 	SS-8271-1V 	N/A 		



4.7L	MOTOR	MODELOS	DESDE / A	JUNTA DE CABEZA		MÚLTIPLE DE ADMISIÓN O PLENO
ENGINE	MODELS	FROM / TO	HEAD GASKET		INTAKE	
V8, SOHC 16V VIN J, P, N MOTOR POWER TECH CABEZA DE MLS	RAM 1500, 2500, GRAND CHE-ROKEE, DURANGO, DAKOTA (CABEZA EN MLS).	1999/2005	CA-272-ML 		MS-4272 	
FS-272-ML						
DISTRIBUCIÓN		RETÉN CIGÜEÑAL	SELLOS DE VALVULA		JUNTAS VARIAS	N/A
TIMING COVER		CRANK SEAL	STEM SEALS		MISCELLANEOUS	
TC-6272	 BS-7271 	 SS-8271-1V 				

5.2L	MOTOR	MODELOS	DESDE / A	JUNTA DE CABEZA		MÚLTIPLE DE ADMISIÓN O PLENO
ENGINE	MODELS	FROM / TO	HEAD GASKET		INTAKE	
V8, OHV 16V VIN Y	B150, B250, B350, W150, W250, RAMCHARGER, DAKOTA.	1989/1992	CA-275-G 		MS-4275 	
FS-275						
DISTRIBUCIÓN		RETÉN CIGÜEÑAL	SELLOS DE VALVULA		JUNTAS VARIAS	N/A
TIMING COVER		CRANK SEAL	STEM SEALS		MISCELLANEOUS	
TC-6270	 BS-7260 	 SS-8261-1V 				



5.2L	MOTOR	MODELOS	DESDE / A	JUNTA DE CABEZA	MULTIPLE DE ADMISIÓN O PLENO
ENGINE	MODELS	FROM / TO	HEAD GASKET	INTAKE	
V8, OHV 16V VIN Y, T	RAM 1500, 2500, 3500, DURANGO, GRAND CHEVROKKEE, B1500, 2500, 3500	1992/2002	CA-275-G	MS-4275-1	
FS-275-2			MULTIPLE DE ESCAPE	PUNTERIAS	CARTER
			EXHAUST	VALVE COVER	OIL PAN
			MS-4275-E	VS-3275-HD	OS-1275-R
DISTRIBUCIÓN		RETÉN CIGÜEÑAL	SELLOS DE VALVULA	JUNTAS VARIAS	N/A
TIMING COVER		CRANK SEAL	STEM SEALS	MISCELLANEOUS	
TC-6270		BS-7270-R	SS-8270-V	N/A	







5.7L	MOTOR	MODELOS	DESDE / A	JUNTA DE CABEZA	MULTIPLE DE ADMISIÓN O PLENO
ENGINE	MODELS	FROM / TO	HEAD GASKET	INTAKE	
V8, OHV 16V MOTOR HEMI CABEZA DE GRAFITO	300C, CHALLENGER, CHARGER.	2005/2012	CA-273-G Y CA-274-G	MS-4273	
			<p>PARA VER IMAGEN DIRIGIRSE A SECCIÓN DE JUNTAS DE CABEZA.</p> <p>TO SEE IMAGE GO TO SECTION HEAD GASKETS</p>		
FS-273			MULTIPLE DE ESCAPE	PUNTERIAS	CARTER
			EXHAUST	VALVE COVER	OIL PAN
			MS-4273-E	VS-3273-R	OS-1273-R
DISTRIBUCIÓN		RETÉN CIGÜEÑAL	SELLOS DE VALVULA	JUNTAS VARIAS	N/A
TIMING COVER		CRANK SEAL	STEM SEALS	MISCELLANEOUS	
TC-6273		BS-7271	SS-8273-V	N/A	



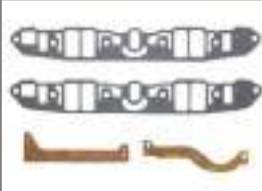

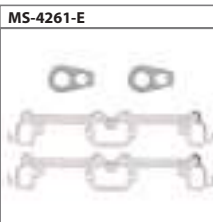
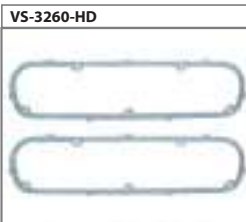

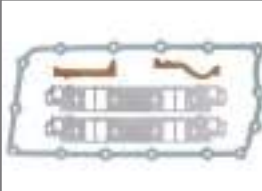

5.7L	MOTOR	MODELOS	DESDE / A	JUNTA DE CABEZA	MÚLTIPLE DE ADMISIÓN O PLENO
ENGINE	MODELS	FROM / TO	HEAD GASKET	INTAKE	
V8, OHV 16V MOTOR HEMI CABEZA DE MLS	RAM 1500, 2500, 3500, DURANGO, GRAND CHE- ROKEE, COMAN- DER	2003/2009	<p>CA-273-ML Y CA-279-ML</p> <p>PARA VER IMAGEN DIRIGIRSE A SECCIÓN DE JUNTAS DE CABEZA.</p> <p>TO SEE IMAGE GO TO SECTION HEAD GASKETS</p>	MS-4273	
FS-273-ML					
DISTRIBUCIÓN		RETÉN CIGÜEÑAL	SELLOS DE VALVULA	JUNTAS VARIAS	
TIMING COVER		CRANK SEAL	STEM SEALS	MISCELLANEOUS	
TC-6273		BS-7271			
EXHAUST		PUNTERIAS		CARTER	
MS-4273-E		VALVE COVER		OIL PAN	
		VS-3273-R		OS-1273-1R	

5.9L	MOTOR	MODELOS	DESDE / A	JUNTA DE CABEZA	MÚLTIPLE DE ADMISIÓN O PLENO
ENGINE	MODELS	FROM / TO	HEAD GASKET	INTAKE	
V8, OHV 16V VIN W, 5, Z, T, W, U	RAMCHARGER, W150, W250, W350, D250, D350, CAMION MICRO	1981/1989	<p>CA-260-G</p>	MS-4260	
FS-260-3					
DISTRIBUCIÓN		RETÉN CIGÜEÑAL	SELLOS DE VALVULA	JUNTAS VARIAS	N/A
TIMING COVER		CRANK SEAL	STEM SEALS	MISCELLANEOUS	
TC-6256		BS-7260			
EXHAUST		PUNTERIAS		CARTER	
MS-4261-E		VALVE COVER		OIL PAN	
		VS-3260		OS-1256-3	

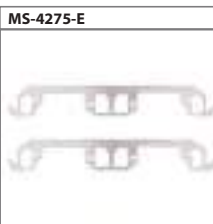
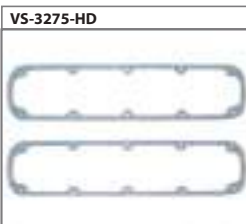

5.9L	MOTOR	MODELOS	DESDE / A	JUNTA DE CABEZA		MULTIPLE DE ADMISIÓN O PLENO	
ENGINE	MODELS	FROM / TO	HEAD GASKET		INTAKE		
V8, OHV 16V VIN 5, Z	RAMCHARGER, D150, D250, D350, W150, W250, W350, MICROBUS	1990/1992					
FS-260-6 			MULTIPLE DE ESCAPE EXHAUST 		PUNTERIAS VALVE COVER 		
DISTRIBUCIÓN TIMING COVER 			RETÉN CIGÜEÑAL CRANK SEAL 			SELLOS DE VALVULA STEM SEALS 	
TC-6256			BS-7260			JUNTAS VARIAS MISCELLANEOUS N/A	

5.9L	MOTOR	MODELOS	DESDE / A	JUNTA DE CABEZA		MULTIPLE DE ADMISIÓN O PLENO	
ENGINE	MODELS	FROM / TO	HEAD GASKET		INTAKE		
V8, OHV 16V VIN Z MOTOR MAGNUM	RAM 1500, 2500, 3500, DURANGO, DAKOTA	1993/2003					
FS-275-1 			MULTIPLE DE ESCAPE EXHAUST 		PUNTERIAS VALVE COVER 		
DISTRIBUCIÓN TIMING COVER 			RETÉN CIGÜEÑAL CRANK SEAL 			SELLOS DE VALVULA STEM SEALS 	
TC-6270			BS-7275-R			JUNTAS VARIAS MISCELLANEOUS N/A	

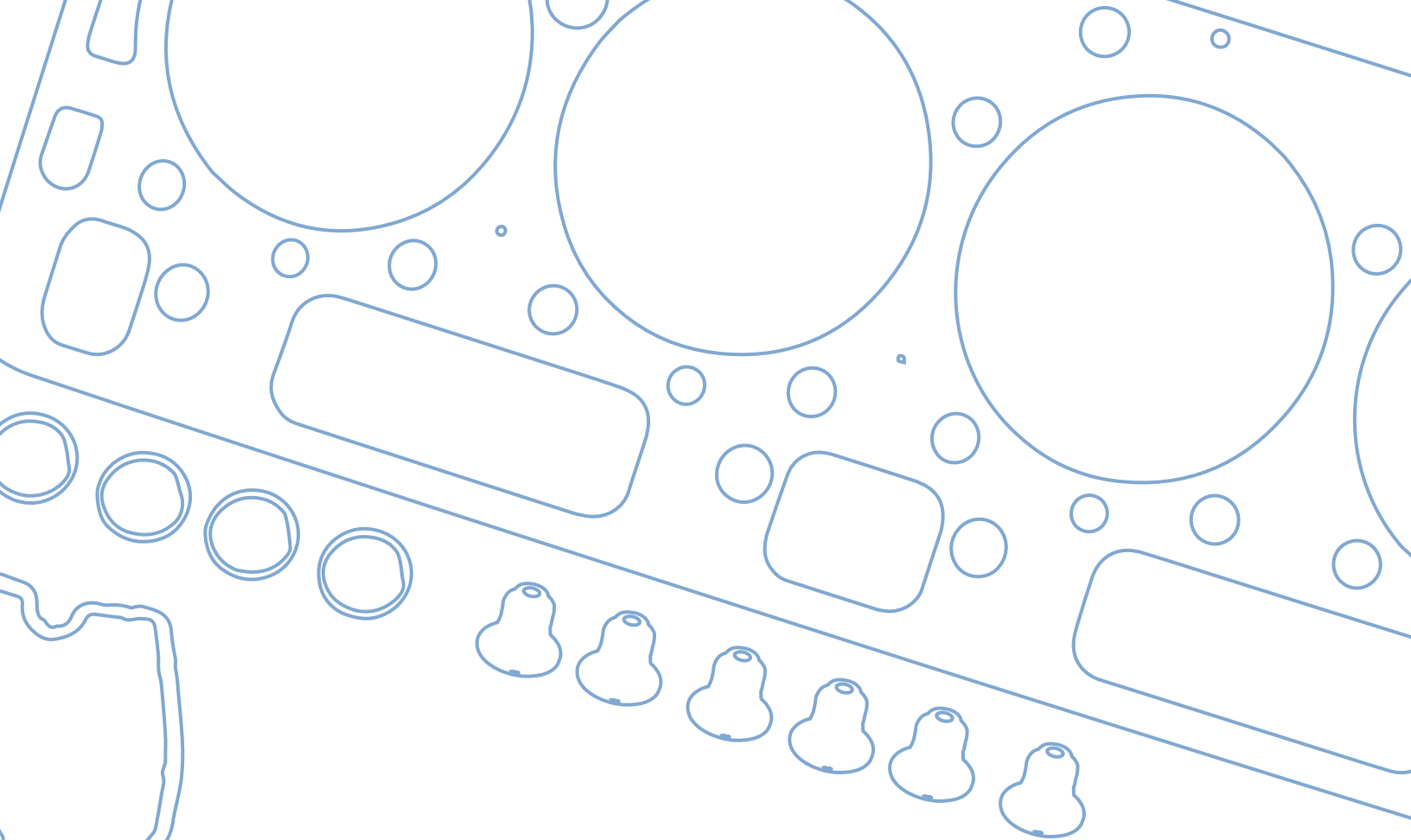

FORD

**MARCA
/MAKE**

CATÁLOGO DE APLICACIONES / APPLICATION CATALOG

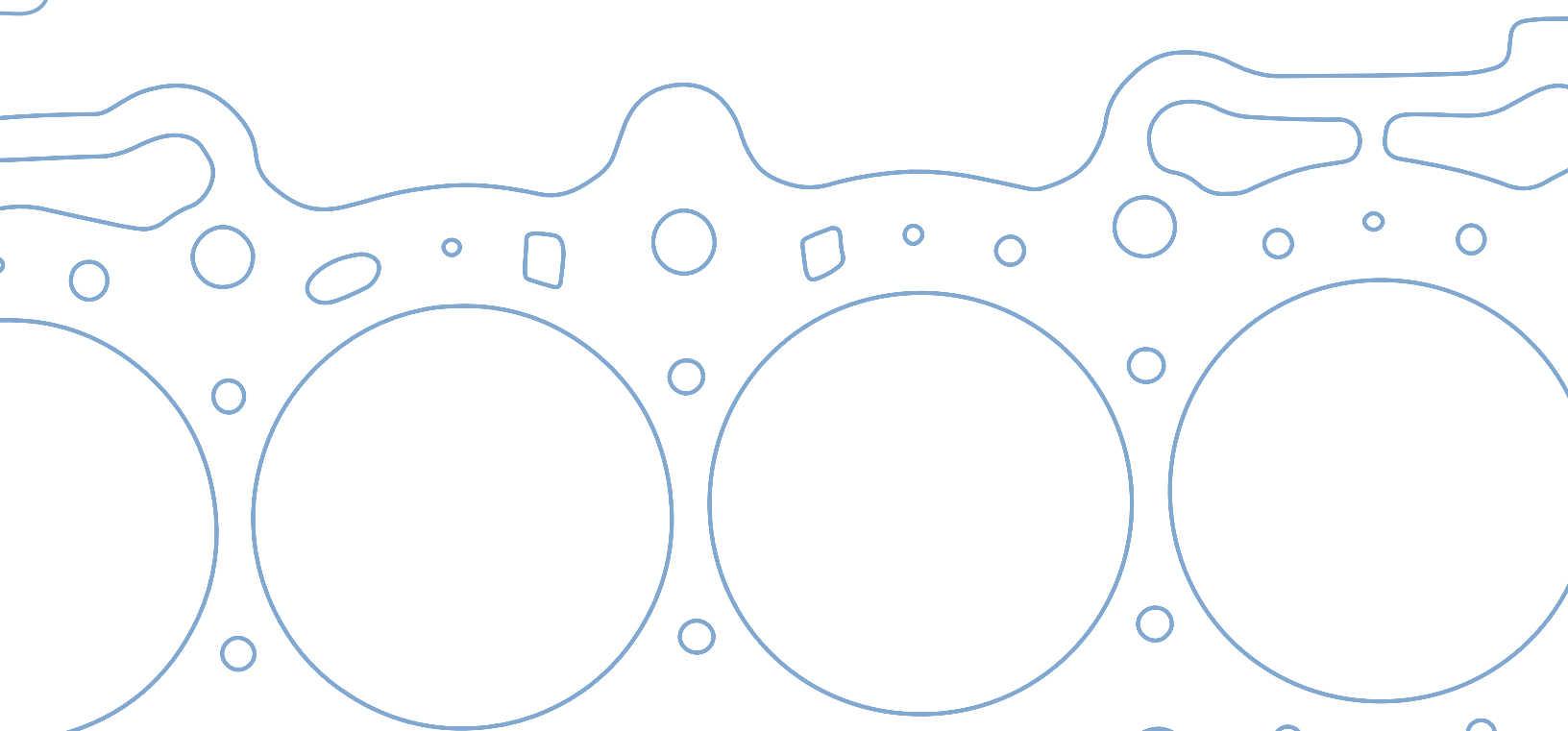

FORD

LITROS	MODELO	AÑO	PÁGINA
LITERS	MODEL	YEAR	PAGE
1.3L	FIESTA.	1997/2001	55
1.4L	FIESTA.	1998/2001	*
1.6L	FIESTA, IKON, Ka, COURIER.	2001/2010	55
1.6L	MAZDA 3.	2006/2007	*
1.8L	ESCORT, TRACER.	1991/1996	*
1.8L	COURIER PICKUP	1974	*
1.9L	MERCURY TRACER, ESCORT.	1981/1999	56
1.9L	ESCORT TRACER.	1991/1996	56
2.0L	ESCORT, TRACER, FOCUS.	1981/2004	57
2.0L	FOCUS.	2000/2004	57
2.0L	MAZDA B2000, COURIER.	1970/1984	58
2.0L	COURIER MA/MB	1979/1982	58
2.0L	COURIER PICKUP ; MAZDA 626, B2000	1979/1984	*
2.0L	RANGER.	1983-1986	59
2.0L	RANGER	1987/1988	59
2.0L	CONTOUR, ESCORT, FOCUS, ZX2.	1995/1997	60
2.0L	CONTOUR, MYSTIQUE, ESCORT,	1995/1999	*
2.0L	FOCUS, ESCORT	2001/2003	*
2.0L	FOCUS SVT	2002/2004	*
2.0L	FOCUS	2000/2003	*
2.0L	ECOSPORT, FOCUS.	2001/2010	60
2.0L	ECOSPORT, MEXICO.	2005/2009	*
2.0L	ECOSPORT	2005/2008	61
2.2L	TRANSIT VAN.	2008/2012	*
2.3L	TEMPO, TOPAZ.	1984/1994	61
2.3L	RANGER.	1974/2002	62
2.3L	RANGER	1981/1986	62
2.3L	MUSTANG, COUGAR, MARQUIS	1986/1988	63
2.3L	MUSTANG, RANGER	1989/1990	63
2.3L	RANGER	1988/1992	64
2.3L	RANGER	1985/1986	64
2.3L	RANGER	1986/1987	65
2.3L	RANGER	1993/1994	65
2.3L	RANGER	1998/2001	66
2.3L	FUSION, MILAN, MAZDA 3.	2006/2009	*
2.4L	FALCON, MAVERICK, CUSTOM ECONOLINE.	1960/1983	*
2.5L	TEMPO, TOPAZ GLS	1989/1994	66
2.5L	CONTOUR, MYSTIQUE, MAZDA MPV.	1995/2000	*
2.5L	CONTOUR, MYSTIQUE.	1995/2000	*
2.5L	PROBE, 626, MILLENIA.	1993/1997	*
2.5L	CONTOUR, TAURUS,MYSTIQUE	1995/2002	*
2.5L	COUGAR, MAZDA MPV.	2001/2002	*
2.8L	AEROSTAR, BRONCO II, RANGER.	1974/1986	67
2.8L	AEROSTAR BRONCO II RANGER	1983/1986	67
2.8L	BRONCO II, RANGER.	1974/1986	*



LITROS	MODELO	AÑO	PÁGINA
LITERS	MODEL	YEAR	PAGE
2.8L	FALCON, MAVERICK, CUSTOM ECONOLINE,	1960/1972	*
2.9L	RANGER, BRONCO II, SCORPIO	1986/1992	68
2.9L	EXPLORER, RANGER.	1986/1992	*
3.0L	RANGER, AEROSTAR, TAURUS.	1986/1990	68
3.0L	RANGER	1990	69
3.0L	TAURUS SABLE TEMPO TOPAZ	1992/1994	69
3.0L	AEROSTAR, B3000.	1986/1990	70
3.0L	AEROSTAR	1990/1990	70
3.0L	AEROSTAR	1996/1997	71
3.0L	AEROSTAR, B3000.	1986/1995	*
3.0L	TAURUS, SABLE.	1999/2004	*
3.0L	TAURUS.	2001/2004	*
3.0L	ESCAPE, TAURUS, SABLE.	2001/2004	*
3.0L	TAURUS, TRIBUTE, SABLE.	1999/2004	*
3.0L	SABLE, TAURUS	2000/2002	*
3.0L	LINCOLN LS	2002/2005	*
3.5L	CUSTOM, WAGON PICK-UP.	1954-1964	71
3.8L	FORD FAIRMONT.	1982/1983	72
3.8L	COUGAR, THUNDERBIRD	1984/1987	72
3.8L	COUGAR, THUNDERBIRD	1988/1994	*
3.8L	COUGAR, THUNDERBIRD SUPERCHARGED	1989/1993	73
3.8L	TAURUS, CONTINENTAL, SABLE	1994/1995	73
3.8L	WINDSTAR	1998/2001	*
3.8L	WINDSTAR.	1994/1995	74
3.8L	TAURUS, CONTINENTAL, SABLE	1989/1993	74
3.8L	AUTOS, WINDSTAR	1994/1995	75
3.8L	WINDSTAR, ECONOLINE.	1997/1998	75
3.8L	MUSTANG, WINDSTAR, LOBO F-150.	1995/2003	*
3.8L	WINDSTAR, F-150,	1997/1998	76
3.8L	WINDSTAR, F-150, ECONOLINE	1997/1998	76
3.8L	WINDSTAR, F-150, ECONOLINE	2001/2004	77
3.8L	WINDSTAR, F-150, LOBO.	1995/2003	*
3.8L	LOBO, E-150, F-150, PICK-UP.	1998/2004	*
3.9L	AUTOS Y CAMIONETAS.	1965/1986	*
3.9L	AUTOS Y CAMIONETAS	1987	*
3.9L	CAMIONES, AUTOS	1955/1959	*
4.0L	EXPLORER, RANGER.	1990/1994	77
4.0L	AEROSTAR, EXPLORER, RANGER	1997/2000	78
4.0L	EXPLORER, MONTAINNER.	1997/2001	78
4.0L	EXPLORER, MONTAINNER.	1997/2010	*
4.0L	EXPLORER, RANGER.	1997/2010	*
4.1L	AUTOS CAMIONES	1969/1980	79
4.2L	AUTOS MERCURY.	1949/1954	*
4.2L	MUSTANG, THUNDERBIRD, CAPRI.	1980/1982	*
4.6L	C.VICTORIA, CONTINENTAL, GRAND MARQUIS.	1991/1994	79

* Escanear código QR para consultar en catálogo electrónico o diríjase a catalogo.dcp.com.mx.



LITROS	MODELO	AÑO	PÁGINA
LITERS	MODEL	YEAR	PAGE
4.6L	MUSTANG , GRAND MARQUIS.	1995/1998	80
4.6L	F-250 PICK-UP	1996/1999	80
4.6L	F-150,F-250,LOBO TRUCKS	1997/1999	81
4.6L	GRAND MARQUIS, F-150, F250, LOBO.	2000/2003	81
4.6L	GRAND MARQUIS, F-150, F250, LOBO.	1997/1999	82
4.9L	BRONCO,ECONOLINE,F-150,F-250	1988/1991	*
4.9L	BRONCO,ECONOLINE,F-150,F-250	1991/1997	*
4.9L	BRONCO,ECONOLINE,F-150,F-250	1991/1992	*
4.9L	BRONCO,ECONOLINE,F-150,F-250	1988/1997	*
5.0L	AUTOS Y CAMIONES.	1962/1997	*
5.0L	BRONCO,CUSTOM,ECONOLINE,MUSTANG	1962/1978	82
5.0L	BRONCO,CUSTOM,ECONOLINE,MUSTANG	1979/1982	83
5.0L	AUTOS Y CAMIONES	1982/1985	83
5.0L	GRAND MARQUIS ,CROWN VICTORIA	1986/1990	84
5.0L	F-250,F-350,COUGAR,THUNDERBIRD	1991/1997	84
5.0L	COUGAR,GRAND MARQUIS,F-250,	1991/1997	85
5.4L	AUTOS Y CAMIONES.	1961/1976	85
5.4L	F-250, F-150, LOBO , G, MARQUIS.	1991/2007	*
5.4L	F-150,F-250,LOBO TRUCKS	1997/1998	*
5.4L	F-150, F250, LOBO.	1991/2009	*
5.4L	EXPEDITION , LOBO, F-150, F-250 NAVIGATOR.	2004/2010	*
5.4L	TRUCKS F-500	1973/1978	*
5.8L	TRUCKS, GALAXIE, GRAND MARQUIS.	1969/1983	86
5.8L	AUTOS Y CAMIONES	1975/983	86
5.8L	AUTOS Y CAMIONES	1984/1990	87
5.8L	F-250,F-350,MICROBUS	1991/1997	87
5.8L	F-150, PICK-UP, TRUCKS.	1970/1982	88
6.1L	CAMIONES.	1979/1989	88
6.8L	TRUCKS, F-450 SUPER DUTY.	1997/1999	89
6.8L	TRUCKS, F-450 SUPER DUTY, EXCURSION.	1997/2003	*
6.8L	F-450,SUPER DUTY.	1999/2007	*
6.8L	ECONOLINE, SUPER DUTY , F-450.	1997/2003	*
7.0L	GALAXIE, CUSTOM 500, F-350, F-600.	1968/1985	89
7.3L	F SUPER DUTY ,F-250-E250-E-350	1988/1995	*
7.3L	E-250, E-350, ECONOLINE.	1994/2003	*
7.5L	GALAXIE, CUSTOM 500, F-350, F-700.	1968/1985	90
7.5L	E-250,SUPER DUTY F-250	1988/1997	*



1.3L	MOTOR	MODELOS	DESDE / A	JUNTA DE CABEZA	MULTIPLE DE ADMISIÓN O PLENO
ENGINE	MODELS	FROM / TO	HEAD GASKET	INTAKE	
4L OHV 8V ENDURA	FIESTA.	1997/2001	CA-302-G 	MS-4302 	
FS-302 			MULTIPLE DE ESCAPE EXHAUST MS-4302-E 	PUNTERIAS VALVE COVER VS-3302 	CARTER OIL PAN OS-1302
DISTRIBUCIÓN TIMING COVER TC-6302 	RETÉN CIGÜEÑAL CRANK SEAL BS-7302 	SELLOS DE VALVULA STEM SEALS SS-8302-V 	JUNTAS VARIAS MISCELLANEOUS		

1.6L	MOTOR	MODELOS	DESDE / A	JUNTA DE CABEZA	MULTIPLE DE ADMISIÓN O PLENO
ENGINE	MODELS	FROM / TO	HEAD GASKET	INTAKE	
4L SOHC 8V ZETEC ROCAM	FIESTA, IKON, Ka, COURIER.	2001/2010	CA-317-G Y CA-317-GX PARA VER IMAGEN DIRIGIRSE A SECCIÓN DE JUNTAS DE CABEZA. TO SEE IMAGE GO TO SECTION HEAD GASKETS	MS-4317 	
FS-317 			MULTIPLE DE ESCAPE EXHAUST MS-4317-E 	PUNTERIAS VALVE COVER VS-3317-R 	CARTER OIL PAN OS-1317-R
DISTRIBUCIÓN TIMING COVER TC-6317 	RETÉN CIGÜEÑAL CRANK SEAL BS-7317-NT 	SELLOS DE VALVULA STEM SEALS SS-8317-V 	JUNTAS VARIAS MISCELLANEOUS		



1.9L	MOTOR	MODELOS	DESDE / A	JUNTA DE CABEZA	MULTIPLE DE ADMISIÓN O PLENO
ENGINE	MODELS	FROM / TO	HEAD GASKET	INTAKE	
4L SOHC 8V	MERCURY TRACER, ESCORT.	1981/1999	CA-303-G 	MS-4303 	
FS-303 			MULTIPLE DE ESCAPE EXHAUST	PUNTERIAS VALVE COVER	CARTER OIL PAN
			MS-4303-E 	VS-3303 	OS-1303
DISTRIBUCIÓN TIMING COVER	RETÉN CIGÜEÑAL CRANK SEAL		SELLOS DE VALVULA STEM SEALS	JUNTAS VARIAS MISCELLANEOUS	
TC-6303-2 	BS-7300 		SS-8303-V 		









1.9L	MOTOR	MODELOS	DESDE / A	JUNTA DE CABEZA	MULTIPLE DE ADMISIÓN O PLENO
ENGINE	MODELS	FROM / TO	HEAD GASKET	INTAKE	
4L SOHC 8V	ESCORT TRACER.	1991/1996	CA-303-1G 	MS-4301 	
FS-303-2 			MULTIPLE DE ESCAPE EXHAUST	PUNTERIAS VALVE COVER	CARTER OIL PAN
			MS-4303-E 	VS-3303-2 	OS-1303-1R
DISTRIBUCIÓN TIMING COVER	RETÉN CIGÜEÑAL CRANK SEAL		SELLOS DE VALVULA STEM SEALS	JUNTAS VARIAS MISCELLANEOUS	
TC-6303-2 	BS-7300 		SS-8301-V 		





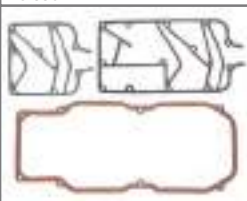



2.0L	MOTOR	MODELOS	DESDE / A	JUNTA DE CABEZA	MULTIPLE DE ADMISIÓN O PLENO	
ENGINE	MODELS	FROM / TO	HEAD GASKET	INTAKE		
4L SOHC 8V	ESCORT, TRACER, FOCUS.	1981/2004	CA-303-1G 	MS-4301 		
FS-303-1 			MULTIPLE DE ESCAPE EXHAUST	PUNTERIAS VALVE COVER	CARTER OIL PAN	
			MS-4303-E 	VS-3303-1R 	OS-1303-1R 	
DISTRIBUCIÓN TIMING COVER		RETÉN CIGÜEÑAL CRANK SEAL		SELLOS DE VALVULA STEM SEALS		JUNTAS VARIAS MISCELLANEOUS
TC-6303-2		BS-7300		SS-8301-V		

2.0L	MOTOR	MODELOS	DESDE / A	JUNTA DE CABEZA	MULTIPLE DE ADMISIÓN O PLENO	
ENGINE	MODELS	FROM / TO	HEAD GASKET	INTAKE		
4L SOHC 8V SPI	FOCUS	2000/2005	CA-303-1G 	MS-4303-3 		
FS-303-4 			MULTIPLE DE ESCAPE EXHAUST	PUNTERIAS VALVE COVER	CARTER OIL PAN	
			MS-4303-E 	VS-3303-3HD 	OS-1303-2R 	
DISTRIBUCIÓN TIMING COVER		RETÉN CIGÜEÑAL CRANK SEAL		SELLOS DE VALVULA STEM SEALS		JUNTAS VARIAS MISCELLANEOUS
TC-6303-2		BS-7300		SS-8301-V		

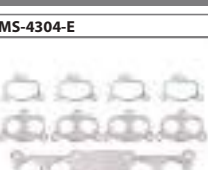
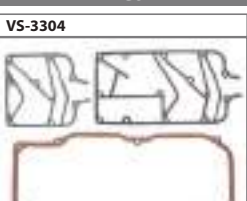

2.0L	MOTOR	MODELOS	DESDE / A	JUNTA DE CABEZA	MULTIPLE DE ADMISIÓN O PLENO
ENGINE	MODELS	FROM / TO	HEAD GASKET	INTAKE	
4L OHV	MAZDA B2000, COURIER.	1970/1984	CA-304-G 	MS-4304 	
FS-304 			MULTIPLE DE ESCAPE EXHAUST MS-4304-E 	PUNTERIAS VALVE COVER VS-3304 	CARTER OIL PAN OS-1304 
DISTRIBUCIÓN TIMING COVER TC-6304 	RETÉN CIGÜEÑAL CRANK SEAL BS-7304 	SELLOS DE VALVULA STEM SEALS SS-8304-V 	JUNTAS VARIAS MISCELLANEOUS		

2.0L	MOTOR	MODELOS	DESDE / A	JUNTA DE CABEZA	MULTIPLE DE ADMISIÓN O PLENO
ENGINE	MODELS	FROM / TO	HEAD GASKET	INTAKE	
4L SOHC 8V	COURIER MA/MB	1979/1982	CA-304-G 	MS-4304-1 	
FS-304-1 			MULTIPLE DE ESCAPE EXHAUST MS-4304-E 	PUNTERIAS VALVE COVER VS-3304 	CARTER OIL PAN OS-1304 
DISTRIBUCIÓN TIMING COVER TC-6304 	RETÉN CIGÜEÑAL CRANK SEAL BS-7304 	SELLOS DE VALVULA STEM SEALS SS-8304-V 	JUNTAS VARIAS MISCELLANEOUS		



2.0L	MOTOR	MODELOS	DESDE / A	JUNTA DE CABEZA	MULTIPLE DE ADMISIÓN O PLENO
ENGINE	MODELS	FROM / TO	HEAD GASKET	INTAKE	
4L SOHC 8V CARB	RANGER.	1983-1986	CA-306-G	MS-4306	
FS-306 			 	 	
			MULTIPLE DE ESCAPE	PUNTERIAS	CARTER
			EXHAUST	VALVE COVER	OIL PAN
			MS-4305-E	VS-3306	OS-1305
DISTRIBUCIÓN	RETÉN CIGÜEÑAL			SELLOS DE VALVULA	JUNTAS VARIAS
TIMING COVER	CRANK SEAL			STEM SEALS	MISCELLANEOUS
TC-6305	BS-7305			SS-8300	RE-16018

2.0L	MOTOR	MODELOS	DESDE / A	JUNTA DE CABEZA	MULTIPLE DE ADMISIÓN O PLENO
ENGINE	MODELS	FROM / TO	HEAD GASKET	INTAKE	
4L SOHC 8V	RANGER	1987/1988	CA-306-G	MS-4306	
FS-306-1 			 	 	
			MULTIPLE DE ESCAPE	PUNTERIAS	CARTER
			EXHAUST	VALVE COVER	OIL PAN
			MS-4305-E	VS-3305	OS-1305-2R
DISTRIBUCIÓN	RETÉN CIGÜEÑAL			SELLOS DE VALVULA	JUNTAS VARIAS
TIMING COVER	CRANK SEAL			STEM SEALS	MISCELLANEOUS
TC-6305	BS-7305			SS-8331-V	RE-16018



2.0L	MOTOR	MODELOS	DESDE / A	JUNTA DE CABEZA		MÚLTIPLE DE ADMISIÓN O PLENO
ENGINE	MODELS	FROM / TO	HEAD GASKET		INTAKE	
4L DOHC 16V	CONTOUR, ESCORT, FOCUS, ZX2.	1995/1997	CA-313-G		MS-4313	
FS-313						
MÚLTIPLE DE ESCAPE		PUNTERIAS		CARTER		
EXHAUST		VALVE COVER		OIL PAN		
MS-4313-E		VS-3313-R		OS-1313-R		
DISTRIBUCIÓN		RETÉN CIGÜEÑAL		SELLOS DE VALVULA		JUNTAS VARIAS
TIMING COVER		CRANK SEAL		STEM SEALS		MISCELLANEOUS
TC-6313				SS-8313-V		

2.0L	MOTOR	MODELOS	DESDE / A	JUNTA DE CABEZA		MÚLTIPLE DE ADMISIÓN O PLENO
ENGINE	MODELS	FROM / TO	HEAD GASKET		INTAKE	
4L DOHC 16V VIN D,H	ECOSPORT, FOCUS.	2001/2010	CA-348-G		MS-4348	
FS-348						
MÚLTIPLE DE ESCAPE		PUNTERIAS		CARTER		
EXHAUST		VALVE COVER		OIL PAN		
MS-4348-E		VS-3348-R				
DISTRIBUCIÓN		RETÉN CIGÜEÑAL		SELLOS DE VALVULA		JUNTAS VARIAS
TIMING COVER		CRANK SEAL		STEM SEALS		MISCELLANEOUS
TC-6348		BS-7348-AT		SS-8348-V		



2.0L	MOTOR	MODELOS	DESDE / A	JUNTA DE CABEZA		MÚLTIPLE DE ADMISIÓN O PLENO
ENGINE	MODELS	FROM / TO	HEAD GASKET		INTAKE	
4L DOHC 16V VIN H	ECOSPORT	2005/2008	CA-348-G		MS-4348	
DISTRIBUCIÓN		RETÉN CIGÜEÑAL	SELLOS DE VALVULA	JUNTAS VARIAS		
TIMING COVER		CRANK SEAL	STEM SEALS	MISCELLANEOUS		
TC-6348		BS-7348-AT	SS-8348-V			

2.3L	MOTOR	MODELOS	DESDE / A	JUNTA DE CABEZA		MÚLTIPLE DE ADMISIÓN O PLENO
ENGINE	MODELS	FROM / TO	HEAD GASKET		INTAKE	
4L OHV 8V VIN R S X	TEMPO, TOPAZ.	1984/1994	CA-300-G		MS-4300	
DISTRIBUCIÓN		RETÉN CIGÜEÑAL	SELLOS DE VALVULA	JUNTAS VARIAS		
TIMING COVER		CRANK SEAL	STEM SEALS	MISCELLANEOUS		
TC-6300		BS-7300	SS-8300			



2.3L	MOTOR	MODELOS	DESDE / A	JUNTA DE CABEZA		MULTIPLE DE ADMISIÓN O PLENO
ENGINE	MODELS	FROM / TO	HEAD GASKET		INTAKE	
4L SOHC 8V	RANGER.	1974/2002	CA-305-G		MS-4305	
FS-305						
DISTRIBUCIÓN		RETÉN CIGÜEÑAL	SELLOS DE VALVULA		JUNTAS VARIAS	
TIMING COVER		CRANK SEAL	STEM SEALS		MISCELLANEOUS	
TC-6305		BS-7321	SS-8300			

2.3L	MOTOR	MODELOS	DESDE / A	JUNTA DE CABEZA		MULTIPLE DE ADMISIÓN O PLENO
ENGINE	MODELS	FROM / TO	HEAD GASKET		INTAKE	
4L SOHC 8V	RANGER	1981/1986	CA-305-G		MS-4305	
FS-305-1						
DISTRIBUCIÓN		RETÉN CIGÜEÑAL	SELLOS DE VALVULA		JUNTAS VARIAS	
TIMING COVER		CRANK SEAL	STEM SEALS		MISCELLANEOUS	
TC-6305		BS-7305	SS-8300			



2.3L	MOTOR	MODELOS	DESDE / A	JUNTA DE CABEZA	MULTIPLE DE ADMISIÓN O PLENO
ENGINE	MODELS	FROM / TO	HEAD GASKET	INTAKE	
4L SOHC	MUSTANG, COUGAR, MARQUIS	1986/1988	CA-305-G 	MS-4305 	
FS-305-2 			MULTIPLE DE ESCAPE EXHAUST	PUNTERIAS VALVE COVER	CARTER OIL PAN
DISTRIBUCIÓN TIMING COVER			RETÉN CIGÜEÑAL CRANK SEAL	SELLOS DE VALVULA STEM SEALS	JUNTAS VARIAS MISCELLANEOUS
TC-6305 	BS-7305 	SS-8300 			

2.3L	MOTOR	MODELOS	DESDE / A	JUNTA DE CABEZA	MULTIPLE DE ADMISIÓN O PLENO
ENGINE	MODELS	FROM / TO	HEAD GASKET	INTAKE	
4L SOHC 8V	MUSTANG, RANGER	1989/1990	CA-305-G 	MS-4305 	
FS-305-3 			MULTIPLE DE ESCAPE EXHAUST	PUNTERIAS VALVE COVER	CARTER OIL PAN
DISTRIBUCIÓN TIMING COVER			RETÉN CIGÜEÑAL CRANK SEAL	SELLOS DE VALVULA STEM SEALS	JUNTAS VARIAS MISCELLANEOUS
TC-6305 	BS-7305 	SS-8305-8V 			



2.3L	MOTOR	MODELOS	DESDE / A	JUNTA DE CABEZA		MULTIPLE DE ADMISIÓN O PLENO
ENGINE	MODELS	FROM / TO	HEAD GASKET		INTAKE	
4L SOHC 8V CARB	RANGER	1988/1992	CA-305-G		MS-4305	
FS-305-4			MULTIPLE DE ESCAPE		PUNTERIAS	CARTER
			EXHAUST		VALVE COVER	OIL PAN
			MS-4305-E		VS-3305-1R	OS-1305-2R
DISTRIBUCIÓN		RETÉN CIGÜEÑAL		SELLOS DE VALVULA		JUNTAS VARIAS
TIMING COVER		CRANK SEAL		STEM SEALS		MISCELLANEOUS
TC-6305		BS-7305		SS-8305-8V		

2.3L	MOTOR	MODELOS	DESDE / A	JUNTA DE CABEZA		MULTIPLE DE ADMISIÓN O PLENO
ENGINE	MODELS	FROM / TO	HEAD GASKET		INTAKE	
4L SOHC 8V	RANGER	1985/1986	CA-305-G		MS-4305	
FS-305-6			MULTIPLE DE ESCAPE		PUNTERIAS	CARTER
			EXHAUST		VALVE COVER	OIL PAN
			MS-4305-E		VS-3305	OS-1305-2R
DISTRIBUCIÓN		RETÉN CIGÜEÑAL		SELLOS DE VALVULA		JUNTAS VARIAS
TIMING COVER		CRANK SEAL		STEM SEALS		MISCELLANEOUS
TC-6305		BS-7305		SS-8300		



2.3L	MOTOR	MODELOS	DESDE / A	JUNTA DE CABEZA		MULTIPLE DE ADMISIÓN O PLENO	
ENGINE	MODELS	FROM / TO	HEAD GASKET		INTAKE		
4L SOHC 8V	RANGER	1986/1987	CA-305-G		MS-4305		
FS-305-7			MULTIPLE DE ESCAPE	PUNTERIAS	CARTER		
			EXHAUST	VALVE COVER	OIL PAN		
			MS-4305-E	VS-3305	OS-1305-2R		
DISTRIBUCIÓN		RETÉN CIGÜEÑAL		SELLOS DE VALVULA		JUNTAS VARIAS	
TIMING COVER		CRANK SEAL		STEM SEALS		MISCELLANEOUS	
TC-6305		BS-7305		SS-8300			

2.3L	MOTOR	MODELOS	DESDE / A	JUNTA DE CABEZA		MULTIPLE DE ADMISIÓN O PLENO	
ENGINE	MODELS	FROM / TO	HEAD GASKET		INTAKE		
4L SOHC 8V	RANGER	1993/1994	CA-305-G		MS-4305-1		
FS-305-8			MULTIPLE DE ESCAPE	PUNTERIAS	CARTER		
			EXHAUST	VALVE COVER	OIL PAN		
			MS-4305-E	VS-3305-1R	OS-1305-2R		
DISTRIBUCIÓN		RETÉN CIGÜEÑAL		SELLOS DE VALVULA		JUNTAS VARIAS	
TIMING COVER		CRANK SEAL		STEM SEALS		MISCELLANEOUS	
TC-6305		BS-7305		SS-8305-8V			



2.3L	MOTOR	MODELOS	DESDE / A
ENGINE		MODELS	FROM / TO
4L SOHC 8V		RANGER	1998/2001

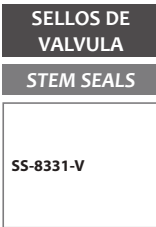
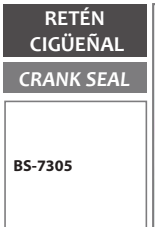
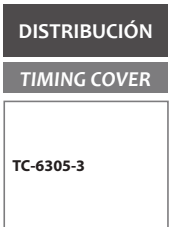
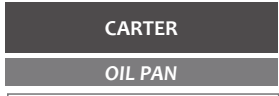
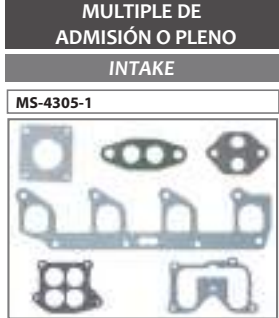

2.5L	MOTOR	MODELOS	DESDE / A
ENGINE		MODELS	FROM / TO
4L OHV 8V		TEMPO, TOPAZ GLS	1989/1994

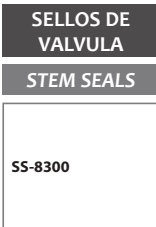
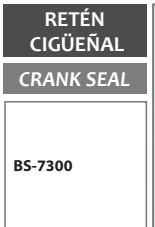
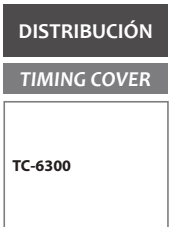
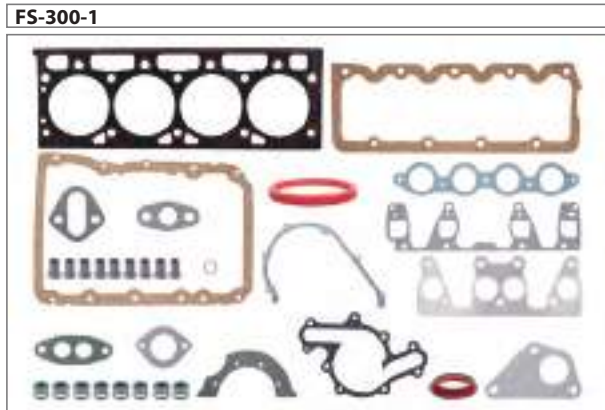



2.8L	MOTOR	MODELOS	DESDE / A	JUNTA DE CABEZA	MULTIPLE DE ADMISIÓN O PLENO	
ENGINE	MODELS	FROM / TO	HEAD GASKET	INTAKE		
V6 OHV 12V	AEROSTAR, BRONCO II, RANGER.	1974/1986	CA-316-G	MS-4315		
FS-315 			 	 		
			MULTIPLE DE ESCAPE	PUNTERIAS	CARTER	
			EXHAUST	VALVE COVER	OIL PAN	
			MS-4315-E	VS-3315	OS-1315	
DISTRIBUCIÓN		RETÉN CIGÜEÑAL		SELLOS DE VALVULA		JUNTAS VARIAS
TIMING COVER		CRANK SEAL		STEM SEALS		MISCELLANEOUS
TC-6315		BS-7315		SS-8303-V		

2.8L	MOTOR	MODELOS	DESDE / A	JUNTA DE CABEZA	MULTIPLE DE ADMISIÓN O PLENO	
ENGINE	MODELS	FROM / TO	HEAD GASKET	INTAKE		
V6 OHV 12V VIN S	AEROSTAR BRONCO II RANGER	1983/1986	CA-315-G Y CA-316-G	MS-4315-1		
FS-315-1 			<p>PARA VER IMAGEN DIRIGIRSE A SECCIÓN DE JUNTAS DE CABEZA.</p> <p>TO SEE IMAGE GO TO SECTION HEAD GASKETS</p>	 		
			MULTIPLE DE ESCAPE	PUNTERIAS	CARTER	
			EXHAUST	VALVE COVER	OIL PAN	
			MS-4315-1E	VS-3315	OS-1315	
DISTRIBUCIÓN		RETÉN CIGÜEÑAL		SELLOS DE VALVULA		JUNTAS VARIAS
TIMING COVER		CRANK SEAL		STEM SEALS		MISCELLANEOUS
TC-6315-1		BS-7315		SS-8303-V		



2.9L	MOTOR	MODELOS	DESDE / A	JUNTA DE CABEZA	MULTIPLE DE ADMISIÓN O PLENO
ENGINE	MODELS	FROM / TO	HEAD GASKET	INTAKE	
V6 OHV 12V CARB	RANGER, BRONCO II, SCORPIO	1986/1992	<p>CA-308-G Y CA-309-G</p> <p>PARA VER IMAGEN DIRIGIRSE A SECCIÓN DE JUNTAS DE CABEZA.</p> <p>TO SEE IMAGE GO TO SECTION HEAD GASKETS</p>	MS-4308-A	
FS-308					
DISTRIBUCIÓN		RETÉN CIGÜEÑAL	SELLOS DE VALVULA	JUNTAS VARIAS	
TIMING COVER		CRANK SEAL	STEM SEALS	MISCELLANEOUS	
TC-6308		BS-7315			







3.0L	MOTOR	MODELOS	DESDE / A	JUNTA DE CABEZA	MULTIPLE DE ADMISIÓN O PLENO
ENGINE	MODELS	FROM / TO	HEAD GASKET	INTAKE	
V6 OHV 12V VULCAN F.I.VIN U VIN 1	RANGER, AEROSTAR, TAURUS.	1986/1990	<p>CA-318-G</p>	MS-4318	
FS-318					
DISTRIBUCIÓN		RETÉN CIGÜEÑAL	SELLOS DE VALVULA	JUNTAS VARIAS	
TIMING COVER		CRANK SEAL	STEM SEALS	MISCELLANEOUS	
TC-6318		BS-7300			





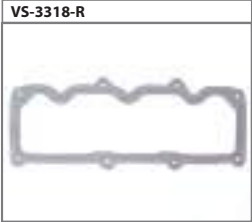
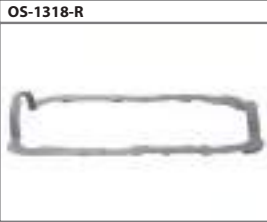



3.0L	MOTOR	MODELOS	DESDE / A	JUNTA DE CABEZA		MÚLTIPLE DE ADMISIÓN O PLENO
ENGINE	MODELS	FROM / TO	HEAD GASKET		INTAKE	
V6 OHV 12V CARTER CORTO	RANGER	MAR1990/ DIC1990	CA-318-G		MS-4318	
DISTRIBUCIÓN		RETÉN CIGÜEÑAL	SELLOS DE VALVULA		JUNTAS VARIAS	
TIMING COVER		CRANK SEAL	STEM SEALS		MISCELLANEOUS	
TC-6318		BS-7300				

3.0L	MOTOR	MODELOS	DESDE / A	JUNTA DE CABEZA		MÚLTIPLE DE ADMISIÓN O PLENO
ENGINE	MODELS	FROM / TO	HEAD GASKET		INTAKE	
V6 OHV 12V VULCAN F.I.VIN U VIN 1	TAURUS SABLE TEMPO TOPAZ	1992/1994	CA-318-G		MS-4318	
DISTRIBUCIÓN		RETÉN CIGÜEÑAL	SELLOS DE VALVULA		JUNTAS VARIAS	
TIMING COVER		CRANK SEAL	STEM SEALS		MISCELLANEOUS	
TC-6318		BS-7300				

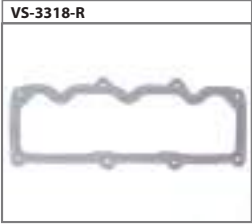
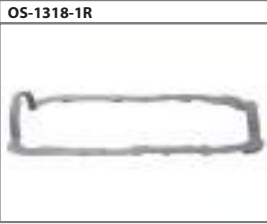

3.0L	MOTOR	MODELOS	DESDE / A	JUNTA DE CABEZA	MULTIPLE DE ADMISIÓN O PLENO
ENGINE	MODELS	FROM / TO	HEAD GASKET	INTAKE	
V6 OHV 12V	AEROSTAR, B3000.	1986/1990	CA-322-G Y CA-323-G PARA VER IMAGEN DIRIGIRSE A SECCIÓN DE JUNTAS DE CABEZA. TO SEE IMAGE GO TO SECTION HEAD GASKETS	MS-4318 	
FS-322 			MULTIPLE DE ESCAPE EXHAUST	PUNTERIAS VALVE COVER	CARTER OIL PAN
			MS-4318-E 	VS-3318-R 	OS-1318-R 
DISTRIBUCIÓN TIMING COVER		RETÉN CIGÜEÑAL CRANK SEAL		SELLOS DE VALVULA STEM SEALS	JUNTAS VARIAS MISCELLANEOUS
TC-6318		BS-7300	SS-8141-V 		

3.0L	MOTOR	MODELOS	DESDE / A	JUNTA DE CABEZA	MULTIPLE DE ADMISIÓN O PLENO
ENGINE	MODELS	FROM / TO	HEAD GASKET	INTAKE	
V6 OHV 12V 1G-576, 577-BA,	AEROSTAR	1990/1990	CA-322-G Y CA-323-G PARA VER IMAGEN DIRIGIRSE A SECCIÓN DE JUNTAS DE CABEZA. TO SEE IMAGE GO TO SECTION HEAD GASKETS	MS-4318 	
FS-322-1 			MULTIPLE DE ESCAPE EXHAUST	PUNTERIAS VALVE COVER	CARTER OIL PAN
			MS-4318-E 	VS-3318-R 	OS-1318-1R 
DISTRIBUCIÓN TIMING COVER		RETÉN CIGÜEÑAL CRANK SEAL		SELLOS DE VALVULA STEM SEALS	JUNTAS VARIAS MISCELLANEOUS
TC-6318		BS-7300	SS-8141-V 		



3.0L	MOTOR	MODELOS	DESDE / A	JUNTA DE CABEZA	MULTIPLE DE ADMISIÓN O PLENO	
ENGINE	MODELS	FROM / TO	HEAD GASKET	INTAKE		
V6 OHV 12V 1G-576, 577-AA	AEROSTAR	1996/1997	CA-322-G Y CA-323-G	MS-4318		
FS-322-2 			PARA VER IMAGEN DIRIGIRSE A SECCIÓN DE JUNTAS DE CABEZA. TO SEE IMAGE GO TO SECTION HEAD GASKETS			
			MULTIPLE DE ESCAPE	PUNTERIAS	CARTER	
			EXHAUST	VALVE COVER	OIL PAN	
			MS-4318-E	VS-3318-1R	OS-1318-1R	
DISTRIBUCIÓN		RETÉN CIGÜEÑAL		SELLOS DE VALVULA		JUNTAS VARIAS
TIMING COVER		CRANK SEAL		STEM SEALS		MISCELLANEOUS
TC-6318		BS-7300		SS-8141-V		

3.5L	MOTOR	MODELOS	DESDE / A	JUNTA DE CABEZA	MULTIPLE DE ADMISIÓN O PLENO	
ENGINE	MODELS	FROM / TO	HEAD GASKET	INTAKE		
V6 OHV 12V	CUSTOM, WAGON PICK-UP.	1954-1964	CA-310-G	MS-4310		
FS-310 						
			MULTIPLE DE ESCAPE	PUNTERIAS	CARTER	
			EXHAUST	VALVE COVER	OIL PAN	
				VS-3310	OS-1310	
DISTRIBUCIÓN		RETÉN CIGÜEÑAL		SELLOS DE VALVULA		JUNTAS VARIAS
TIMING COVER		CRANK SEAL		STEM SEALS		MISCELLANEOUS
TC-6310		BS-7310		SS-8310		



3.8L	MOTOR	MODELOS	DESDE / A	JUNTA DE CABEZA		MULTIPLE DE ADMISIÓN O PLENO
ENGINE	MODELS	FROM / TO	HEAD GASKET		INTAKE	
V6 OHV 12 CARB.	FORD FAIRMONT.	1982/1983	CA-330-G		MS-4330	
DISTRIBUCIÓN		RETÉN CIGÜEÑAL	SELLOS DE VALVULA	JUNTAS VARIAS		
TIMING COVER		CRANK SEAL	STEM SEALS	MISCELLANEOUS		
TC-6330		BS-7360				





3.8L	MOTOR	MODELOS	DESDE / A	JUNTA DE CABEZA		MULTIPLE DE ADMISIÓN O PLENO
ENGINE	MODELS	FROM / TO	HEAD GASKET		INTAKE	
V6 OHV 12 CARB.	COUGAR, THUNDERBIRD	1984/1987	CA-330-G		MS-4330-1	
DISTRIBUCIÓN		RETÉN CIGÜEÑAL	SELLOS DE VALVULA	JUNTAS VARIAS		
TIMING COVER		CRANK SEAL	STEM SEALS	MISCELLANEOUS		
TC-6330-1		BS-7360				





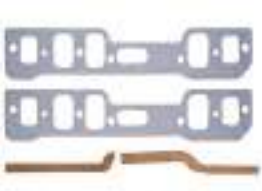

3.8L	MOTOR	MODELOS	DESDE / A	JUNTA DE CABEZA	MÚLTIPLE DE ADMISIÓN O PLENO
ENGINE	MODELS	FROM / TO	HEAD GASKET	INTAKE	
V6 OHV 12	COUGAR, THUNDERBIRD SUPERCHARGED	1989/1993	CA-330-G 	MS-4330-2 	
FS-330-3 			MÚLTIPLE DE ESCAPE EXHAUST	PUNTERIAS VALVE COVER	CARTER OIL PAN
TC-6330-2 			RETÉN CIGÜEÑAL CRANK SEAL	SELLOS DE VALVULA STEM SEALS	JUNTAS VARIAS MISCELLANEOUS
		BS-7305 	SS-8330 		

3.8L	MOTOR	MODELOS	DESDE / A	JUNTA DE CABEZA	MÚLTIPLE DE ADMISIÓN O PLENO
ENGINE	MODELS	FROM / TO	HEAD GASKET	INTAKE	
V6 OHV 12V	TAURUS, CONTINENTAL, SABLE	1994/1995	CA-330-G 	MS-4330-4 	
FS-330-4 			MÚLTIPLE DE ESCAPE EXHAUST	PUNTERIAS VALVE COVER	CARTER OIL PAN
TC-6330-2 			RETÉN CIGÜEÑAL CRANK SEAL	SELLOS DE VALVULA STEM SEALS	JUNTAS VARIAS MISCELLANEOUS
		BS-7305 	SS-8330 		

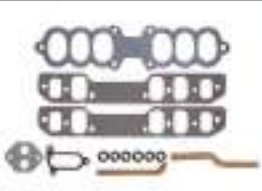

3.8L	MOTOR	MODELOS	DESDE / A	JUNTA DE CABEZA	MÚLTIPLE DE ADMISIÓN O PLENO
ENGINE	MODELS	FROM / TO	HEAD GASKET	INTAKE	
V6 OHV 12V MPFI	WINDSTAR.	1994/1995	CA-332-G 	MS-4330-4 	
FS-332					
DISTRIBUCIÓN		RETÉN CIGÜEÑAL		SELLOS DE VALVULA	JUNTAS VARIAS
TIMING COVER		CRANK SEAL		STEM SEALS	MISCELLANEOUS
TC-6330-2		BS-7305	SS-8330		
					OS-1330-2 

3.8L	MOTOR	MODELOS	DESDE / A	JUNTA DE CABEZA	MÚLTIPLE DE ADMISIÓN O PLENO
ENGINE	MODELS	FROM / TO	HEAD GASKET	INTAKE	
V6 OHV 12V MPFI	TAURUS, CONTINENTAL, SABLE	1989/1993	CA-332-G 	MS-4330-2 	
FS-332-1					
DISTRIBUCIÓN		RETÉN CIGÜEÑAL		SELLOS DE VALVULA	JUNTAS VARIAS
TIMING COVER		CRANK SEAL		STEM SEALS	MISCELLANEOUS
TC-6330-2		BS-7305	SS-8330-V		
					OS-1330-2 



3.8L	MOTOR	MODELOS	DESDE / A	JUNTA DE CABEZA	MULTIPLE DE ADMISIÓN O PLENO
ENGINE	MODELS	FROM / TO	HEAD GASKET	INTAKE	
V6 OHV 12V MPFI	AUTOS ,WINDSTAR	1994/1995	CA-332-G 	MS-4330-2 	
FS-332-2 			MULTIPLE DE ESCAPE EXHAUST	PUNTERIAS VALVE COVER	CARTER OIL PAN
			MS-4330-1E 	VS-3330-2R 	OS-1330-2
DISTRIBUCIÓN TIMING COVER		RETÉN CIGÜEÑAL CRANK SEAL		SELLOS DE VALVULA STEM SEALS	JUNTAS VARIAS MISCELLANEOUS
TC-6330-2		BS-7305	SS-8305-16V 		

3.8L	MOTOR	MODELOS	DESDE / A	JUNTA DE CABEZA	MULTIPLE DE ADMISIÓN O PLENO
ENGINE	MODELS	FROM / TO	HEAD GASKET	INTAKE	
V6 OHV 12V VIN 2,4	WINDSTAR, ECO-NOLINE.	1997/1998	CA-341-G Y CA-342-G PARA VER IMAGEN DIRIGIRSE A SECCIÓN DE JUNTAS DE CABEZA. TO SEE IMAGE GO TO SECTION HEAD GASKETS	MS-4341 	
FS-341 			MULTIPLE DE ESCAPE EXHAUST	PUNTERIAS VALVE COVER	CARTER OIL PAN
			MS-4341-E 	VS-3330-2R 	OS-1338
DISTRIBUCIÓN TIMING COVER		RETÉN CIGÜEÑAL CRANK SEAL		SELLOS DE VALVULA STEM SEALS	JUNTAS VARIAS MISCELLANEOUS
TC-6330-2		BS-7360	SV-8305-1V 		



3.8L	MOTOR	MODELOS	DESDE / A	JUNTA DE CABEZA	MÚLTIPLE DE ADMISIÓN O PLENO
ENGINE	MODELS	FROM / TO	HEAD GASKET	INTAKE	
V6 OHV 12V	WINDSTAR, F-150.	1997/1998	CA-342-G Y CA-341-G PARA VER IMAGEN DIRIGIRSE A SECCIÓN DE JUNTAS DE CABEZA. TO SEE IMAGE GO TO SECTION HEAD GASKETS	MS-4341-1	
FS-341-1					
DISTRIBUCIÓN		RETÉN CIGÜEÑAL	SELLOS DE VALVULA	JUNTAS VARIAS	
TIMING COVER		CRANK SEAL	STEM SEALS	MISCELLANEOUS	
TC-6330-2		BS-7360	SS-8341-V		

3.8L	MOTOR	MODELOS	DESDE / A	JUNTA DE CABEZA	MÚLTIPLE DE ADMISIÓN O PLENO
ENGINE	MODELS	FROM / TO	HEAD GASKET	INTAKE	
V6 OHV 12V	WINDSTAR ,F-150, ECONOLINE	1997/1998	CA-341-G Y CA-342-G PARA VER IMAGEN DIRIGIRSE A SECCIÓN DE JUNTAS DE CABEZA. TO SEE IMAGE GO TO SECTION HEAD GASKETS	MS-4341-1	
FS-341-2					
DISTRIBUCIÓN		RETÉN CIGÜEÑAL	SELLOS DE VALVULA	JUNTAS VARIAS	
TIMING COVER		CRANK SEAL	STEM SEALS	MISCELLANEOUS	
TC-6330-2		BS-7360	SS-8331-1V		



3.8L	MOTOR	MODELOS	DESDE / A	JUNTA DE CABEZA	MULTIPLE DE ADMISIÓN O PLENO
ENGINE	MODELS	FROM / TO	HEAD GASKET	INTAKE	
V6 OHV 12V	WINDSTAR, F-150, ECONOLINE	2001/2004	<p>CA-341-G Y CA-342-G</p> <p>PARA VER IMAGEN DIRIGIRSE A SECCIÓN DE JUNTAS DE CABEZA.</p> <p>TO SEE IMAGE GO TO SECTION HEAD GASKETS</p>	MS-4341-1	
FS-341-3					
DISTRIBUCIÓN		RETÉN CIGÜEÑAL	SELLOS DE VALVULA		
TIMING COVER		CRANK SEAL	STEM SEALS		
TC-6330-2		BS-7360			JUNTAS VARIAS
					MISCELLANEOUS

4.0L	MOTOR	MODELOS	DESDE / A	JUNTA DE CABEZA	MULTIPLE DE ADMISIÓN O PLENO
ENGINE	MODELS	FROM / TO	HEAD GASKET	INTAKE	
V6 OHV 12V VIN X	EXPLORER, RANGER.	1990/1994	<p>CA-335-G Y CA-336-G</p> <p>PARA VER IMAGEN DIRIGIRSE A SECCIÓN DE JUNTAS DE CABEZA.</p> <p>TO SEE IMAGE GO TO SECTION HEAD GASKETS</p>	MS-4335-A	
FS-335					
DISTRIBUCIÓN		RETÉN CIGÜEÑAL	SELLOS DE VALVULA		
TIMING COVER		CRANK SEAL	STEM SEALS		
TC-6335		BS-7315			JUNTAS VARIAS
					MISCELLANEOUS



4.0L	MOTOR	MODELOS	DESDE / A
ENGINE		MODELS	FROM / TO
V6 OHV 12V VIN X		AEROSTAR, EXPLORER, RANGER	1997/2000

FS-335-1

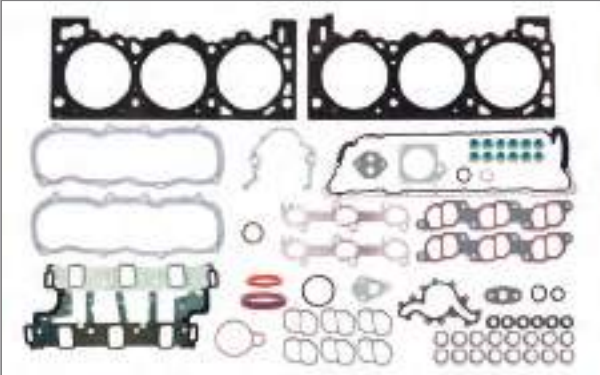

JUNTA DE CABEZA	
HEAD GASKET	
CA-337-G Y CA-338-G	
<p>PARA VER IMAGEN DIRIGIRSE A SECCIÓN DE JUNTAS DE CABEZA.</p> <p>TO SEE IMAGE GO TO SECTION HEAD GASKETS</p>	

MULTIPLE DE ADMISIÓN O PLENO
INTAKE
MS-4335-1A

MULTIPLE DE ESCAPE
EXHAUST
MS-4335-E

PUNTERIAS
VALVE COVER
VS-3335-1R

CARTER
OIL PAN
OS-1335-1R

DISTRIBUCIÓN
TIMING COVER
TC-6335



RETÉN CIGÜEÑAL
CRANK SEAL
BS-7315



SELLOS DE VALVULA
STEM SEALS
SV-8335-V



JUNTAS VARIAS
MISCELLANEOUS

4.0L	MOTOR	MODELOS	DESDE / A
ENGINE		MODELS	FROM / TO
V6 OHV 12V VIN E		EXPLORER, MOUNTAINNER.	1997/2001

FS-337-G



JUNTA DE CABEZA	
HEAD GASKET	
CA-337-G Y CA-338-G	
<p>PARA VER IMAGEN DIRIGIRSE A SECCIÓN DE JUNTAS DE CABEZA.</p> <p>TO SEE IMAGE GO TO SECTION HEAD GASKETS</p>	

MULTIPLE DE ADMISIÓN O PLENO
INTAKE
MS-4337

MULTIPLE DE ESCAPE
EXHAUST
MS-4337-E

PUNTERIAS
VALVE COVER
VS-3337-1R

CARTER
OIL PAN
OS-1335-1R

DISTRIBUCIÓN
TIMING COVER
TC-6337



RETÉN CIGÜEÑAL
CRANK SEAL
BS-7315



SELLOS DE VALVULA
STEM SEALS
SS-8337-V









JUNTAS VARIAS
MISCELLANEOUS





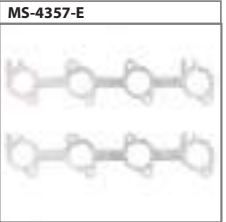
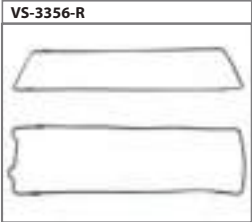
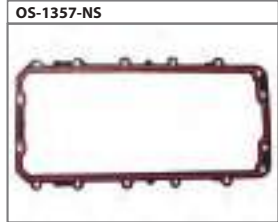

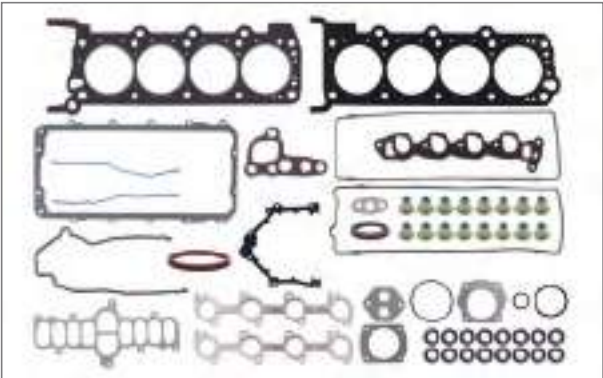
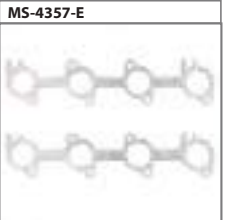
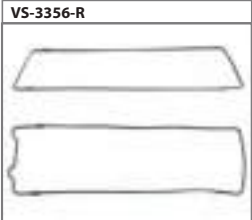

4.1L	MOTOR	MODELOS	DESDE / A	JUNTA DE CABEZA	MULTIPLE DE ADMISIÓN O PLENO
ENGINE	MODELS	FROM / TO	HEAD GASKET	INTAKE	
6L OHV 12V	AUTOS CAMIONES	1969/1980	CA-320-G	MS-4320	
FS-320-1			MULTIPLE DE ESCAPE	PUNTERIAS	CARTER
			EXHAUST	VALVE COVER	OIL PAN
			MS-4320	VS-3320	OS-1320
DISTRIBUCIÓN	RETÉN CIGÜEÑAL		SELLOS DE VALVULA	JUNTAS VARIAS	
TIMING COVER	CRANK SEAL		STEM SEALS	MISCELLANEOUS	
TC-6320	BS-7320		SS-8365		

4.6L	MOTOR	MODELOS	DESDE / A	JUNTA DE CABEZA	MULTIPLE DE ADMISIÓN O PLENO
ENGINE	MODELS	FROM / TO	HEAD GASKET	INTAKE	
V8 SOHC 16V TRITON ROMEO	C.VICTORIA, CONTINENTAL, GRAND MARQUIS.	1991/1994	CA-356-ML Y CA-357-ML	MS-4357	
			<p>PARA VER IMAGEN DIRIGIRSE A SECCIÓN DE JUNTAS DE CABEZA.</p> <p>TO SEE IMAGE GO TO SECTION HEAD GASKETS</p>		
FS-356			MULTIPLE DE ESCAPE	PUNTERIAS	CARTER
			EXHAUST	VALVE COVER	OIL PAN
			MS-4357-E	VS-3356-R	OS-1357-NS
DISTRIBUCIÓN	RETÉN CIGÜEÑAL		SELLOS DE VALVULA	JUNTAS VARIAS	
TIMING COVER	CRANK SEAL		STEM SEALS	MISCELLANEOUS	
TC-6356	BS-7360		SS-8356-V		



4.6L	MOTOR	MODELOS	DESDE / A	JUNTA DE CABEZA	MULTIPLE DE ADMISIÓN O PLENO
ENGINE	MODELS	FROM / TO	HEAD GASKET	INTAKE	
V8 SOHC 16V TRITON	MUSTANG , GRAND MARQUIS.	1995/1998	CA-356-G Y CA-357-G PARA VER IMAGEN DIRIGIRSE A SECCIÓN DE JUNTAS DE CABEZA. TO SEE IMAGE GO TO SECTION HEAD GASKETS	MS-4357 	
FS-356-1 			MULTIPLE DE ESCAPE EXHAUST	PUNTERIAS VALVE COVER	CARTER OIL PAN
			MS-4357-E 	VS-3356-R 	OS-1357-NS 
DISTRIBUCIÓN TIMING COVER		RETÉN CIGÜEÑAL CRANK SEAL		SELLOS DE VALVULA STEM SEALS	JUNTAS VARIAS MISCELLANEOUS
TC-6356		BS-7360	SS-8357-V 		

4.6L	MOTOR	MODELOS	DESDE / A	JUNTA DE CABEZA	MULTIPLE DE ADMISIÓN O PLENO
ENGINE	MODELS	FROM / TO	HEAD GASKET	INTAKE	
V8 SOHC 16V TRITON	F-250 PICK-UP	1996/1999	CA-356-G Y CA-357-G PARA VER IMAGEN DIRIGIRSE A SECCIÓN DE JUNTAS DE CABEZA. TO SEE IMAGE GO TO SECTION HEAD GASKETS	MS-4357-NS1 	
FS-356-2 			MULTIPLE DE ESCAPE EXHAUST	PUNTERIAS VALVE COVER	CARTER OIL PAN
			MS-4357-E 	VS-3356-R 	OS-1357-NS 
DISTRIBUCIÓN TIMING COVER		RETÉN CIGÜEÑAL CRANK SEAL		SELLOS DE VALVULA STEM SEALS	JUNTAS VARIAS MISCELLANEOUS
TC-6356		BS-7360	SS-8357-V 		



4.6L	MOTOR	MODELOS	DESDE / A	JUNTA DE CABEZA	MÚLTIPLE DE ADMISIÓN O PLENO
ENGINE	MODELS	FROM / TO	HEAD GASKET	INTAKE	
V8 SOHC 16V TRITON	F-150, F-250, LOBO TRUCKS	1997/1999	CA-356-E Y CA-357-G	MS-4357-NS1	
FS-356-3 			<p>PARA VER IMAGEN DIRIGIRSE A SECCIÓN DE JUNTAS DE CABEZA.</p> <p>TO SEE IMAGE GO TO SECTION HEAD GASKETS</p>		
MÚLTIPLE DE ESCAPE EXHAUST		PUNTERIAS VALVE COVER		CARTER OIL PAN	
MS-4357-E		VS-3357-R		OS-1357-NS	
DISTRIBUCIÓN TIMING COVER		RETÉN CIGÜEÑAL CRANK SEAL		SELLOS DE VALVULA STEM SEALS	
TC-6356		BS-7360		SS-8357-V	
				JUNTAS VARIAS MISCELLANEOUS	

4.6L	MOTOR	MODELOS	DESDE / A	JUNTA DE CABEZA	MÚLTIPLE DE ADMISIÓN O PLENO
ENGINE	MODELS	FROM / TO	HEAD GASKET	INTAKE	
V8 SOHC 16V TRITON	GRAND MARQUIS, F-150, F250, LOBO.	2000/2003	CA-356-ML Y CA-357-ML	MS-4357-NS17	
FS-356-2E 			<p>PARA VER IMAGEN DIRIGIRSE A SECCIÓN DE JUNTAS DE CABEZA.</p> <p>TO SEE IMAGE GO TO SECTION HEAD GASKETS</p>		
MÚLTIPLE DE ESCAPE EXHAUST		PUNTERIAS VALVE COVER		CARTER OIL PAN	
MS-4357-E		VS-3356-R		OS-1357	
DISTRIBUCIÓN TIMING COVER		RETÉN CIGÜEÑAL CRANK SEAL		SELLOS DE VALVULA STEM SEALS	
TC-6356		BS-7360		SS-8357-V	
				JUNTAS VARIAS MISCELLANEOUS	



4.6L	MOTOR	MODELOS	DESDE / A	JUNTA DE CABEZA	MULTIPLE DE ADMISIÓN O PLENO
ENGINE	MODELS	FROM / TO	HEAD GASKET	INTAKE	
V8 SOHC 16V TRITON	GRAND MARQUIS, F-150, F250, LOBO.	1997/1999	CA-356-ML Y CA-357-ML	MS-4357-NS11	
FS-356-4			<p>PARA VER IMAGEN DIRIGIRSE A SECCIÓN DE JUNTAS DE CABEZA.</p> <p>TO SEE IMAGE GO TO SECTION HEAD GASKETS</p>		
			MULTIPLE DE ESCAPE	PUNTERIAS	CARTER
			EXHAUST	VALVE COVER	OIL PAN
			MS-4357-E	VS-3357-R	OS-1357-NS
DISTRIBUCIÓN		RETÉN CIGÜEÑAL	SELLOS DE VALVULA	JUNTAS VARIAS	
TIMING COVER		CRANK SEAL	STEM SEALS	MISCELLANEOUS	
TC-6356		BS-7360	SS-8357-V		

5.0L	MOTOR	MODELOS	DESDE / A	JUNTA DE CABEZA	MULTIPLE DE ADMISIÓN O PLENO
ENGINE	MODELS	FROM / TO	HEAD GASKET	INTAKE	
V8 OHV 16V	BRONCO, CUSTOM, ECONOLINE, MUSTANG	1962/1978	CA-360-G	MS-4365-1	
FS-360-1					
			MULTIPLE DE ESCAPE	PUNTERIAS	CARTER
			EXHAUST	VALVE COVER	OIL PAN
			MS-4360-E	VS-3360	OS-1360
DISTRIBUCIÓN		RETÉN CIGÜEÑAL	SELLOS DE VALVULA	JUNTAS VARIAS	
TIMING COVER		CRANKBS- SEAL	STEM SEALS	MISCELLANEOUS	
TC-6360		BS-7321	SS-8365		



5.0L	MOTOR	MODELOS	DESDE / A	JUNTA DE CABEZA		MÚLTIPLE DE ADMISIÓN O PLENO
ENGINE	MODELS	FROM / TO	HEAD GASKET		INTAKE	
V8 OHV 16V	BRONCO, CUSTOM, ECONOLINE, MUSTANG	1979/1982	CA-360-G		MS-4365-2	
FS-360-2 						
DISTRIBUCIÓN		RETÉN CIGÜEÑAL	MÚLTIPLE DE ESCAPE		PUNTERIAS	CARTER
TIMING COVER		CRANK SEAL	EXHAUST		VALVE COVER	OIL PAN
TC-6365		BS-7321		MS-4360-E	VS-3360	OS-1360

5.0L	MOTOR	MODELOS	DESDE / A	JUNTA DE CABEZA		MÚLTIPLE DE ADMISIÓN O PLENO
ENGINE	MODELS	FROM / TO	HEAD GASKET		INTAKE	
V8 OHV 16V 260,289,302,335,351,351W	AUTOS Y CAMIONES	1982/1985	CA-360-G		MS-4365-1	
FS-360-3 						
DISTRIBUCIÓN		RETÉN CIGÜEÑAL	MÚLTIPLE DE ESCAPE		PUNTERIAS	CARTER
TIMING COVER		CRANK SEAL	EXHAUST		VALVE COVER	OIL PAN
TC-6365		BS-7360		MS-4360-E	VS-3360	OS-1360



5.0L	MOTOR	MODELOS	DESDE / A	JUNTA DE CABEZA		MULTIPLE DE ADMISIÓN O PLENO
ENGINE	MODELS	FROM / TO	HEAD GASKET		INTAKE	
V8 OHV 16V ONLY USA ENGINES	GRAND MARQUIS ,CROWN VICTORIA	1986/1990	CA-365-G		MS-4361-1	
FS-360-4			MULTIPLE DE ESCAPE	PUNTERIAS	CARTER	
			EXHAUST	VALVE COVER	OIL PAN	
			MS-4360-E	VS-3360	OS-1360-1R	
DISTRIBUCIÓN	RETÉN CIGÜEÑAL		SELLOS DE VALVULA	JUNTAS VARIAS		
TIMING COVER	CRANK SEAL		STEM SEALS	MISCELLANEOUS		
TC-6365	BS-7360		SS-8365			

5.0L	MOTOR	MODELOS	DESDE / A	JUNTA DE CABEZA		MULTIPLE DE ADMISIÓN O PLENO
ENGINE	MODELS	FROM / TO	HEAD GASKET		INTAKE	
V8 OHV 16V EFI	F-250,F-350,COUGAR,THUNDERBIRD	1991/1997	CA-360		MS-4361-2	
FS-360-5			MULTIPLE DE ESCAPE	PUNTERIAS	CARTER	
			EXHAUST	VALVE COVER	OIL PAN	
			MS-4360-E	VS-3360	OS-1360	
DISTRIBUCIÓN	RETÉN CIGÜEÑAL		SELLOS DE VALVULA	JUNTAS VARIAS		
TIMING COVER	CRANK SEAL		STEM SEALS	MISCELLANEOUS		
TC-6365	BS-7360		SS-8305-16V			



5.0L	MOTOR	MODELOS	DESDE / A	JUNTA DE CABEZA	MULTIPLE DE ADMISIÓN O PLENO
ENGINE	MODELS	FROM / TO	HEAD GASKET	INTAKE	
V8 OHV 16V EFI	COUGAR, GRAND MARQUIS, F-250,	1991/1997	CA-360-G 	MS-4361-2 	
FS-360-6 			MULTIPLE DE ESCAPE EXHAUST MS-4360-E 	PUNTERIAS VALVE COVER VS-3360-R 	CARTER OIL PAN OS-1360-1R
DISTRIBUCIÓN TIMING COVER TC-6365 	RETÉN CIGÜEÑAL CRANK SEAL BS-7300 	SELLOS DE VALVULA STEM SEALS SS-8305-16V 	JUNTAS VARIAS MISCELLANEOUS		

5.4L	MOTOR	MODELOS	DESDE / A	JUNTA DE CABEZA	MULTIPLE DE ADMISIÓN O PLENO
ENGINE	MODELS	FROM / TO	HEAD GASKET	INTAKE	
V8 OHV 16V (332-)352-360-390-410-427-428	AUTOS Y CAMIONES.	1961/1976	CA-355-G 	MS-4355-A 	
FS-355 			MULTIPLE DE ESCAPE EXHAUST MS-4355-E 	PUNTERIAS VALVE COVER VS-3355 	CARTER OIL PAN OS-1355
DISTRIBUCIÓN TIMING COVER TC-6355 	RETÉN CIGÜEÑAL CRANK SEAL BS-7355 	SELLOS DE VALVULA STEM SEALS SS-8355 	JUNTAS VARIAS MISCELLANEOUS		



5.8L	MOTOR	MODELOS	DESDE / A	JUNTA DE CABEZA		MULTIPLE DE ADMISIÓN O PLENO
ENGINE	MODELS	FROM / TO	HEAD GASKET		INTAKE	
V8 OHV 16V (351W)	TRUCKS, GALAXIE, GRAND MARQUIS.	1969/1983	CA-365-G		MS-4365	
DISTRIBUCIÓN		RETÉN CIGÜEÑAL	SELLOS DE VALVULA		JUNTAS VARIAS	
TIMING COVER		CRANK SEAL	STEM SEALS		MISCELLANEOUS	
TC-6365		BS-7320				
			SS-8365			





5.8L	MOTOR	MODELOS	DESDE / A	JUNTA DE CABEZA		MULTIPLE DE ADMISIÓN O PLENO
ENGINE	MODELS	FROM / TO	HEAD GASKET		INTAKE	
V8 OHV 16V (351W) CARBURADO	AUTOS Y CAMIONES	1975/983	CA-365-G		MS-4365	
DISTRIBUCIÓN		RETÉN CIGÜEÑAL	SELLOS DE VALVULA		JUNTAS VARIAS	
TIMING COVER		CRANK SEAL	STEM SEALS		MISCELLANEOUS	
TC-6365		BS-7310				
			SS-8365			





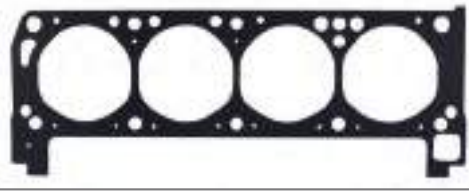

5.8L	MOTOR	MODELOS	DESDE / A	JUNTA DE CABEZA	MULTIPLE DE ADMISIÓN O PLENO
ENGINE	MODELS	FROM / TO	HEAD GASKET	INTAKE	
V8 OHV 16V (351W) (MEXICO 335")	AUTOS Y CAMIONES	1984/1990	CA-365-G 	MS-4360-A 	
FS-365-2 			MULTIPLE DE ESCAPE EXHAUST MS-4360-E 	PUNTERIAS VALVE COVER VS-3360-HD 	CARTER OIL PAN OS-1365-1R
DISTRIBUCIÓN TIMING COVER TC-6365 	RETÉN CIGÜEÑAL CRANK SEAL BS-7320 	SELLOS DE VALVULA STEM SEALS SS-8365 	JUNTAS VARIAS MISCELLANEOUS		

5.8L	MOTOR	MODELOS	DESDE / A	JUNTA DE CABEZA	MULTIPLE DE ADMISIÓN O PLENO
ENGINE	MODELS	FROM / TO	HEAD GASKET	INTAKE	
V8 OHV 16V (351W) F.I.	F-250,F-350,MICROBUS	1991/1997	CA-365-G 	MS-4365-2 	
FS-365-3 			MULTIPLE DE ESCAPE EXHAUST MS-4360-E 	PUNTERIAS VALVE COVER VS-3360 	CARTER OIL PAN OS-1365-1R
DISTRIBUCIÓN TIMING COVER TC-6365 	RETÉN CIGÜEÑAL CRANK SEAL BS-7325 	SELLOS DE VALVULA STEM SEALS SS-8300 	JUNTAS VARIAS MISCELLANEOUS		

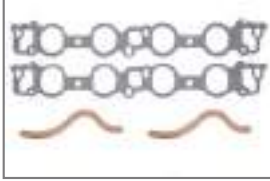

5.8L	MOTOR	MODELOS	DESDE / A	JUNTA DE CABEZA	MULTIPLE DE ADMISIÓN O PLENO
ENGINE	MODELS	FROM / TO	HEAD GASKET	INTAKE	
V8 OHV 16V (351C,400) CARB.	F-150, PICK-UP, TRUCKS.	1970/1982	CA-370-G 	MS-4370-A 	
FS-370					
DISTRIBUCIÓN		RETÉN CIGÜEÑAL	SELLOS DE VALVULA	JUNTAS VARIAS	
TIMING COVER		CRANK SEAL	STEM SEALS	MISCELLANEOUS	
TC-6370		BS-7370	SS-8365		









6.1L	MOTOR	MODELOS	DESDE / A	JUNTA DE CABEZA	MULTIPLE DE ADMISIÓN O PLENO
ENGINE	MODELS	FROM / TO	HEAD GASKET	INTAKE	
V8 OHV 16V (370,389 CID)	CAMIONES.	1979/1989	CA-380-G 	MS-4375 	
FS-380					
DISTRIBUCIÓN		RETÉN CIGÜEÑAL	SELLOS DE VALVULA	JUNTAS VARIAS	
TIMING COVER		CRANK SEAL	STEM SEALS	MISCELLANEOUS	
TC-6376		BS-7142	SS-8365		

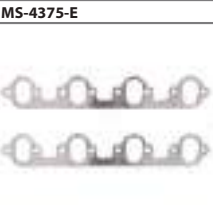

6.8L	MOTOR	MODELOS	DESDE / A	JUNTA DE CABEZA	MÚLTIPLE DE ADMISIÓN O PLENO
ENGINE	MODELS	FROM / TO	HEAD GASKET	INTAKE	
V10 OHV 16V TRITON (415CID)	TRUCKS, F-450 SUPER DUTY.	1997/1999	CA-390-G	MS-4390	
FS-390 			 		
			MÚLTIPLE DE ESCAPE EXHAUST	PUNTERIAS VALVE COVER	CARTER OIL PAN
			MS-4390-E	VS-3390-R	OS-1390
DISTRIBUCIÓN TIMING COVER		RETÉN CIGÜEÑAL CRANK SEAL	SELLOS DE VALVULA STEM SEALS	JUNTAS VARIAS MISCELLANEOUS	
TC-6357		BS-7305	SV-8357-V		

7.0L	MOTOR	MODELOS	DESDE / A	JUNTA DE CABEZA	MÚLTIPLE DE ADMISIÓN O PLENO
ENGINE	MODELS	FROM / TO	HEAD GASKET	INTAKE	
V8 OHV 16V (429,460)	GALAXIE, CUSTOM 500, F-350, F-600.	1968/1985	CA-375-G	MS-4375	
FS-375 			 		
			MÚLTIPLE DE ESCAPE EXHAUST	PUNTERIAS VALVE COVER	CARTER OIL PAN
			MS-4375-E	VS-3375	OS-1375
DISTRIBUCIÓN TIMING COVER		RETÉN CIGÜEÑAL CRANK SEAL	SELLOS DE VALVULA STEM SEALS	JUNTAS VARIAS MISCELLANEOUS	
TC-6375		BS-7142	SS-8365		



7.5L	MOTOR	MODELOS	DESDE / A	JUNTA DE CABEZA		MÚLTIPLE DE ADMISIÓN O PLENO
ENGINE	MODELS	FROM / TO	HEAD GASKET		INTAKE	
V8 OHV 16V (427,460)	GALAXIE, CUSTOM 500, F-350, F-700.	1968/1985	CA-375-G 		MS-4375 	
FS-375 			MÚLTIPLE DE ESCAPE EXHAUST MS-4375-E 	PUNTERIAS VALVE COVER VS-3375 	CARTER OIL PAN OS-1375 	
DISTRIBUCIÓN TIMING COVER TC-6375 	RETÉN CIGÜEÑAL CRANK SEAL BS-7142 	SELLOS DE VALVULA STEM SEALS SS-8365 	JUNTAS VARIAS MISCELLANEOUS			

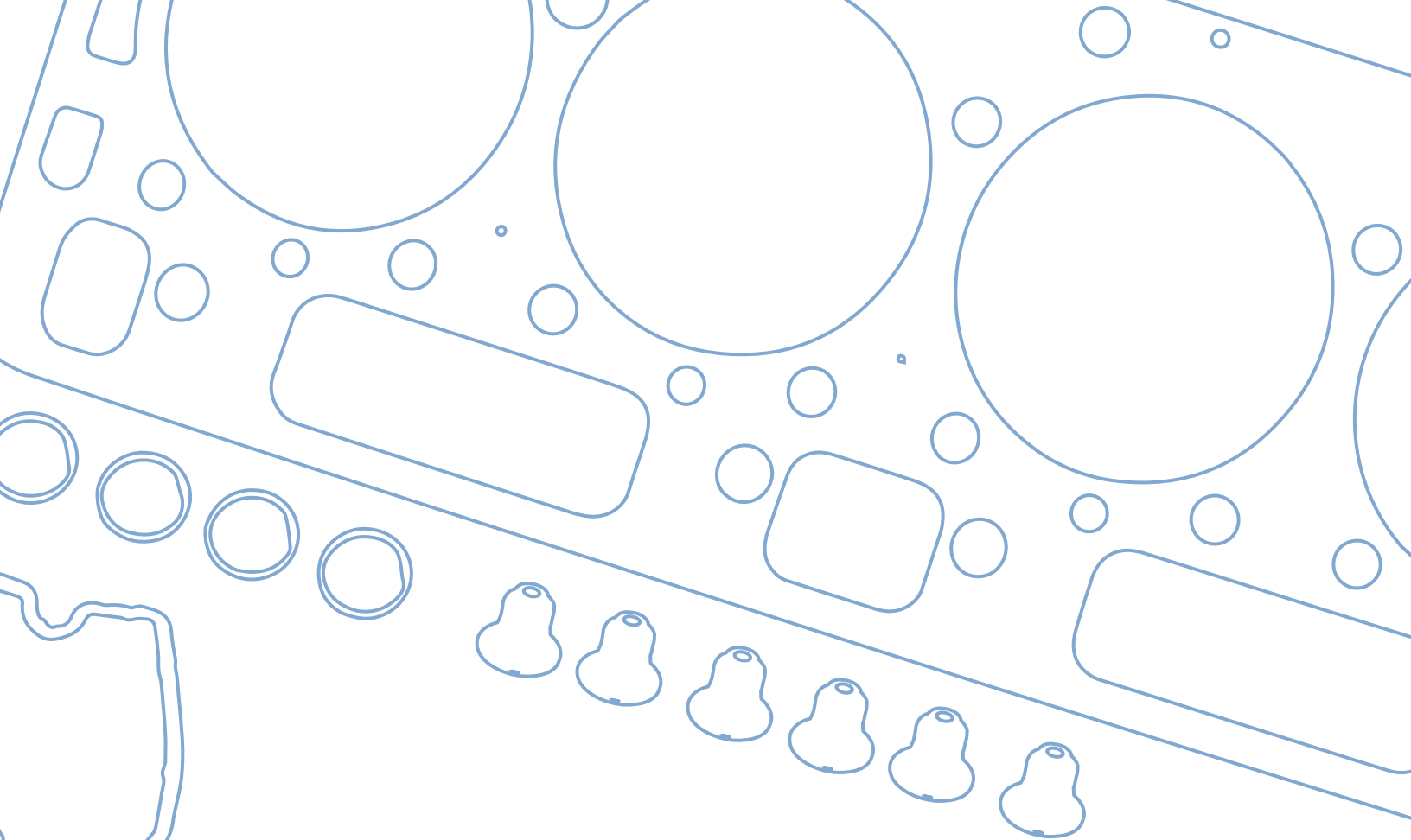

GENERAL MOTORS

MARCA
/MAKE

CATÁLOGO DE APLICACIONES / APPLICATION CATALOG

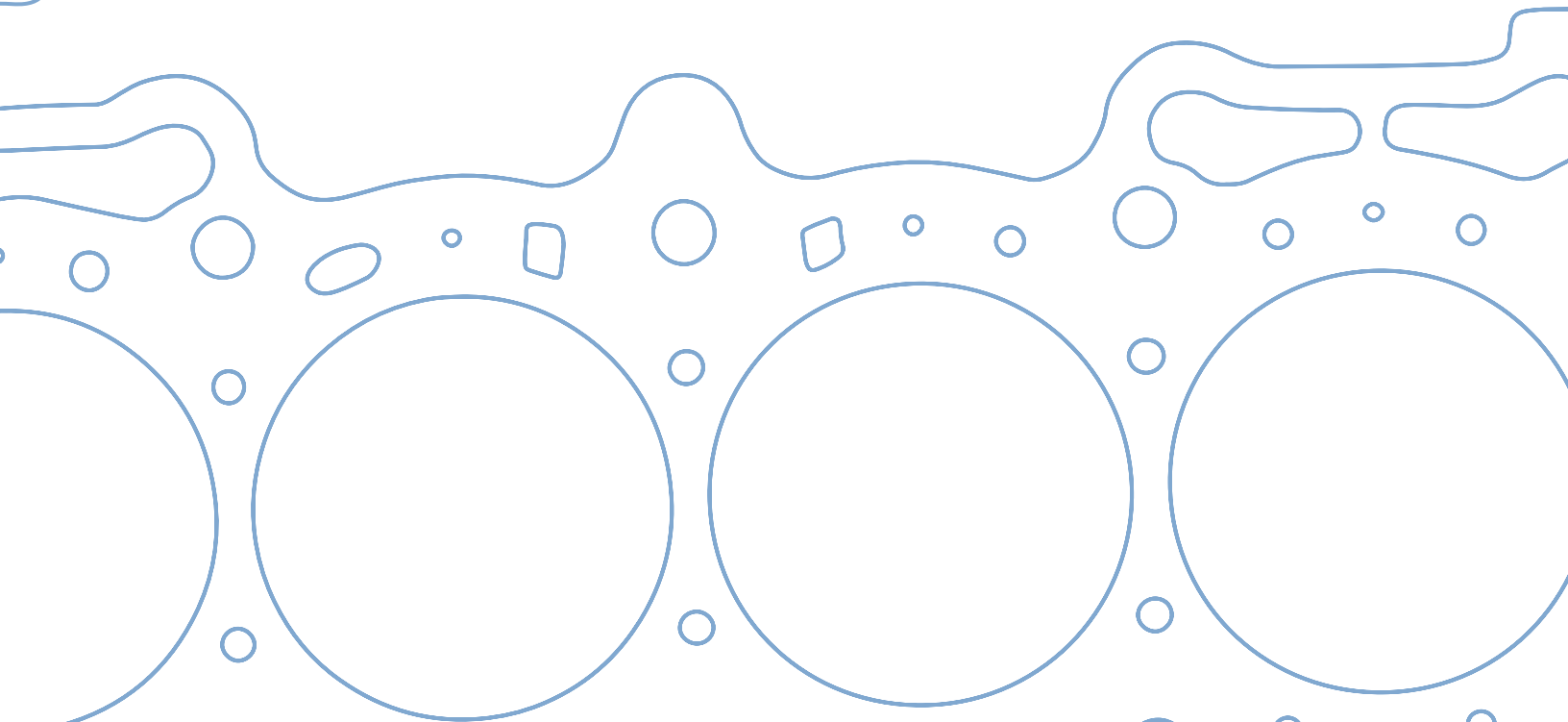



LITROS	MODELO	AÑO	PÁGINA
LITERS	MODEL	YEAR	PAGE
1.0L	SPRINT, FIREFLY, FORSA.	1985/1988	*
1.0L	GEO METRO, SWIFT.	1989/1997	*
1.0L	MATIZ G2.	2004/2010	97
1.2L	SPARK.	2011/2013	97
1.4L	CHEVY POP, JOY, SWING.	1994/2001	98
1.6L	CHEVY MONZA, PICK-UP.	1996/2012	98
1.6L	AVEO, PONTIAC G3 (CABEZA DE GRAFITO).	2008/2012	99
1.6L	AVEO, PONTIAC G3 (CABEZA DE MLS).	2008/2012	99
1.6L	CHEVY NOVA.	1986/1988	*
1.8L	LUV, ISUZU PICK UP.	1972/1982	*
1.8L	PONTIAC SUNBIRD, J200, OLDSMOBILE FIRENZA.	1982/1986	*
1.8L	ASTRA, ZAFIRA.	2000/2008	*
1.8L	CORSA, PICK-UP TORNADO.	2003/2006	100
1.8L	CORSA, PICK-UP TORNADO.	2007/2010	100
1.8L	CRUZE (CABEZA DE GRAFITO).	2011/2013	101
1.8L	CRUZE, (CABEZA DE MLS).	2011/2013	101
1.9L	S10, BLAZER, ISUZU TROOPER.	1982/1985	*
1.9L	SATURN SL, SL1, SC1, SW1.	1991/1995	102
1.9L	SATURN SC, SC2, SL2, SW2.	1991/1995	102
2.0L	CAVALIER, FIRENZA, SKYHAWK, SUNBIRD.	1983/1987	*
2.0L	CAVALIER AMERICANO.	1985/1986	*
2.0L	CAVALIER USA, BERETTA, CORSICA.	1987/1991	103
2.0L	OPTRA, ASTRA, FORENZA.	2004/2010	*
2.0L	TRACKER, SUZUKI VITARA, AERIO, SX4.	1999/2009	*
2.2L	MEXICO PICK-UP LUV PONTIAC BRASIL.	1998/2005	103
2.2L	CAVALIER USA, BERETTA, CORSICA.	1990/1991	104
2.2L	CAVALIER AMERICANO, CUTTLAS, CENTURY.	1992/1993	104
2.2L	CAVALIER, BUICK CENTURY, PONTIAC SUNFIRE SE.	1994/1997	105
2.2L	PICK UP S-10, SONOMA, ISUZU HOMBRE.	1994/1997	105
2.2L	CAVALIER, S-10, SONOMA.	1998/2002	106
2.2L	ASTRA, ZAFIRA, CAVALIER, MALIBU, HHR, PONTIAC SUNFIRE, GRAND AM.	2001/2008	*
2.3L	BERETTA, PONTIAC GRAND AM, GRAND PRIX, CLUTLASS, SKYLARK.	1987/1991	106
2.4L	PONTIAC SUNFIRE, GRAND AM, CAVALIER, MALIBU.	1997/2002	107
2.4L	ALERO, CAVALIER, MALIBU, PONTIAC GRAND AM, SUNFIRE.	1999/2002	*
2.4L	PONTIAC G4, ASTRA.	2004/2006	*
2.5L	CELEBRITY, CITATION, CJ5, CJ7.	1979/1983	*
2.5L	S10, ASTRO, CELEBRITY, JIMMY, PONTIAC FIERO, GRAND AM.	1987	*
2.5L	S10, ASTRO, CELEBRITY, S15, SAFARI, CUTLASS.	1988/1990	107
2.5L	CELEBRITY, CENTURY, CUTLASS, SONOMA, S10, LUMINA.	1990/1993	108
2.5L	CENTURY, SKYLARK, GRAND AM.	1985/1986	*
2.5L	SKYLARK, SOMERSET, CALAIS, GRAND AM.	1987	*
2.5L	GRAND AM, CUTLASS CALAIS, SKYLARK.	1988	*
2.5L	GRAND AM, CUTLASS CALAIS, SKYLARK.	1989/1991	*
2.7L	VITARA, GRAND VITARA.	2006/2010	*



LITROS	MODELO	AÑO	PÁGINA
LITERS	MODEL	YEAR	PAGE
2.8L	COLORADO, CANYON.	2004/2006	108
2.8L	CELEBRITY, CITATION, S10, PONTIAC FIREBIRD.	1980/1984	109
2.8L	CUTLASS, CAVALIER, CELEBRITY, CITATION, COMANCHE, WAGONEER.	1985/1986	109
2.8L	CAMIONETA S-10, SONOMA, CELEBRITY.	1987/1993	110
2.8L	MPFI 2a GENERACION, CAVALIER, CUTLASS, EUROSPOET, CENTURY.	1988/1994	110
2.9L	COLORADO, CANYON, ISUZU I-290.	2007/2012	*
3.0L	BUICK REGAL, LeSABRE, RIVIERA, CAPRICE, EL CAMINO, PONTIAC BONNEVILLE, CUTLASS.	1982/1985	*
3.1L	CAVALIER, CUTLASS, CENTURY.	1988/1995	111
3.1L	LUMINA SEDAN, MALIBU.	2000/2003	111
3.1L	CENTURY, LUMINA, MALIBU, GRAND PRIX.	1995/1999	112
3.3L	CENTURY, CUTLASS, GRAND AM, SKYLARK	1990/1993	*
3.4L	MONTE CARLO, LUMINA, GRAND PRIX, CUTLASS.	1991/1997	*
3.4L	VENTURE, IMPALA, MONTE CARLO, TRANS SPORT, AZTEK, GRAND AM.	1996/2003	112
3.5L	BEL AIR, FLEETMASTER, TWO-TEN SERIES, AUTOS Y CAMIONES TODOS.	1937/1953	*
3.5L	COLORADO, CANYON, H3, i-350.	2004/2006	113
3.5L	AURORA, INTRIGUE.	1999/2002	*
3.6L	ACADIA, EQUINOX, MALIBU, PONTIAC G6, G8, TORRENT, CADILLAC CTS, SRX, STS.	2004/2011	*
3.7L	COLORADO, CANYON, ISUZU I-370, HUMMER H3.	2007/2012	*
3.8L	BEL AIR, AUTOS & CAMIONES.	1953/1962	*
3.8L	AUTOS BUICK, CUTLASS, MONTE CARLO, MALIBU.	1977/1982	*
3.8L	MALIBU, IMPALA, CAPRICE, PONTIAC LeMANS.	1980/1984	*
3.8L	PONTIAC GRAND AM, BONNEVILLE, TRANS SPORT.	1991/1993	*
3.8L	ELECTRA, LE SABRE, REATTA, RIVERA.	1988/1990	*
3.8L	GRAND PRIX, MONTE CARLO, LUMINA, IMPALA, BONNEVILLE.	1997/2005	113
3.8L	GRAND PRIX, BONNEVILLE, MONTE CARLO, IMPALA, RIVIERA, (SUPERCARGADOS).	1997/2005	*
4.0L	OLDSMOBILE AURORA.	1995/2003	*
4.1L	AUTOS Y CAMIONES CARBURADOS & TBI.	1963/1992	114
4.1L	AUTOS Y CAMIONES, USA.	1975/1979	*
4.1L	SERIES C10, C20, C30, K10, K20.	1979	*
4.2L	TRAILBLAZER, ENVOY, ASCENDER, BRAVADA (CABEZA DE GRAFITO).	2002/2006	114
4.2L	TRAILBLAZER, ENVOY, ASCENDER, BRAVADA (CABEZA DE MLS).	2002/2006	*
4.3L	ASTRO, PICKUP C10, C20, C1500, C2500, SAFARI, CAPRICE, EL CAMINO.	1985/1990	115
4.3L	ASTRO, PICK UP S10, S15, C1500, C2500, G10, G20, G30, JIMMY, SAFARI (MOTOR TBI).	1986/1992	115
4.3L	ASTRO, SAFARI.	1986/1992	116
4.3L	SONOMA, S-10, S-15, ASTRO, SAFARI, C1500, C2500, K1500, K2500.	1993	116
4.3L	ASTRO, SAFARI, SONOMA, C1500, C2500, G1500, G2500, G3500, JIMMY.	1994/1995	117
4.3L	ASTRO, S10, BLAZER, SAFARI, SONOMA, S-15, JIMMY.	1992/1993	117
4.3L	ASTRO, SAFARI, S-10, BLAZER, JIMMY.	1994/1995	118
4.3L	SAFARI, ASTRO, SONOMA, S-10, JIMMY, SAVANA 1500, SIERRA 1500, SILVERADO 1500, SONORA, EXPRESS VAN, C1500.	1996/2011	118
4.3L	CAPRICE.	1994/1996	119

* Escanear código QR para consultar en catálogo electrónico o dirígase a catalogo.dcp.com.mx.



LITROS	MODELO	AÑO	PÁGINA
LITERS	MODEL	YEAR	PAGE
4.3L	CUTLASS CALAIS, SUPREME, SALON, CRUISER, BROUGHAM.	1977/1982	*
4.6L	CADILLAC DeVILLE, ELdorado, SEVILLE, PONTIAC BONEVILLE.	2000/2001	*
4.8L	AUTOS Y CAMIONES CARBURADOS & TBI.	1963/1992	119
4.8L	K2500, K3500, C2500, C3500.	1963/1989	*
4.8L	CHEYENNE, SILVERADO 1500, 2500, SUBURBAN, YUKON, SIERRA 1500, 2500, TAHOE (CABEZAS DE GRAFITO).	1999/2001	120
4.8L	CHEYENNE, SILVERADO 1500, 2500, SUBURBAN, YUKON, SIERRA 1500, 2500, TAHOE (CABEZAS DE MLS).	1999/2001	120
4.8L	SUBURBAN, SILVERADO 1500, 2500, SIERRA 1500, 2500, YUKON, AVALANCHE, SAVANA, EXPRESS VAN 1500, 2500, SONORA.	2002/2009	121
5.0L	CAMARO, MALIBU, K10, K20, IMPALA, CHEVELLE, CHEVY NOVA, CORVETTE, CAPRICE, MONTE CARLO, SUBURBAN.	1967/1973	*
5.0L	AUTOS Y CAMIONES.	1976/1980	*
5.0L	CARBURADOS, AUTOS Y CAMIONETAS.	1981/1987	*
5.0L	EXPRESS VAN 1500, 2500, C1500, C2500, K1500, K500, SAVANA.	1996/2002	121
5.0L	CAPRICE, MONTE CARLO, C1500, C2500, CAMARO, PONTIAC GRAND PRIX, FIREBIRD, MOTOR TBI.	1987/1995	122
5.0L	CAMARO, FIREBIRD.	1987/1992	122
5.0L	OLDSMOBILE CUTLASS, PONTIAC BONNEVILLE, BUICK RIVIERA, LeSABRE.	1980/1984	*
5.3L	IMPALA, CORVETTE, MALIBU, EL CAMINO, CHEVELLE, CAPRICE, CAMARO, CAMIONETAS PICK UP.	1965/1979	*
5.3L	CHEYENNE, SILVERADO 1500, 2500, SUBURBAN, YUKON, SIERRA 1500, 2500, TAHOE (CABEZAS DE GRAFITO).	1999/2001	123
5.3L	CHEYENNE, SILVERADO 1500, 2500, SUBURBAN, YUKON, SIERRA 1500, 2500, TAHOE (CABEZAS DE MLS).	1999/2001	123
5.3L	SUBURBAN, SILVERADO 1500, 2500, SIERRA 1500, 2500, YUKON, AVALANCHE, SAVANA, EXPRESS VAN 1500, 2500, SONORA.	2002/2009	124
5.7L	MICROBUS, SUBURBAN, C-2500, C-3500, PICK-UP SOLO MEXICO.	1992/1998	124
5.7L	SUBURBAN, YUKON, EXPRESS VAN 1500, 2500, 3500, SILVERADO 1500, 2500, SONORA, TAHOE, ESCALADE.	1996/2002	125
5.7L	CAMARO, MALIBU, K10, K20, IMPALA, CHEVELLE, CHEVY NOVA, CORVETTE, CAPRICE, MONTE CARLO, SUBURBAN.	1967/1973	*
5.7L	MALIBU, MONTE CARLO, IMPALA, CHEVELLE, CORVETTE, CAPRICE, CAMARO, PICK UP C10, C20, C30, SUBURBAN.	1973/1991	125
5.7L	PICK UP K10, K20, K30, C10, C20, C30, SUBURBAN, IMPALA, MICROBUS.	1981/1986	126
5.7L	AUTOS Y CAMIONES USA.	1987/1988	126
5.7L	CAMIONETAS "TBI" C1500, C2500, C3500, V1500, V2500, V3500, K1500, K2500, K3500, YUKON, TAHOE, BLAZER.	1989/1996	127
5.7L	FIREBIRD, CAMARO Z28, CAPRICE.	1992/1997	127
5.7L	CADILLAC SEVILLE.	1976	*
5.7L	OLDSMOBILE OMEGA, CUTLASS, DELTA, SKYLARK, ELECTRA, CENTURY.	1977/1980	*
6.0L	SILVERADO 2500, SIERRA 2500, YUKON, EXPRESS VAN, CARGO VAN, SUBURBAN (CABEZA DE GRAFITO).	1999/2001	128
6.0L	SILVERADO 2500, SIERRA 2500, YUKON, EXPRESS VAN, CARGO VAN,	1999/2001	128

















GENERAL MOTORS

LITROS	MODELO	AÑO	PÁGINA
LITERS	MODEL	YEAR	PAGE
	SUBURBAN (CABEZAS DE MLS).		
6.0L	SUBURBAN, YUKON, SIERRA 2500, SILVERADO 1500, 2500, 3500, EXPRESS VAN 2500, 3500, CORVETTE, AVALANCHE.	2001/2007	129
6.2L	SUBURBAN 1500, 2500, 3500, PICK UP K1500, 2500, 3500, C1500, C2500, C3500, HUMMER, (DIESEL).	1982/1993	129
6.5L	PICK UP C1500, C2500, C3500, K1500, K2500, K3500, EXPRESS 2500, 3500, SAVANA, YUKON, TAHOE, HUMMER H1, (DIESEL).	1994/2005	130
6.6L	MONTE CARLO, IMPALA, CHEVELLE NOMAD, CAPRICE, BEL AIR, CAMARO, EL CAMINO, PONTIAC FIREBIRD, BONNEVILLE.	1970/1976	*
7.0L	CAMARO, CORVETTE, CAPRICE, IMPALA.	1965/1969	*
7.4L	AUTOS Y CAMIONES.	1970/1980	*
7.4L	PICK UP C1500, C2500, C3500.	1980/1985	*
7.4L	CAMION KODIAK.	1987/1990	*
7.4L	C1500, C2500, C3500, K2500, K3500.	1991/1996	130
7.4L	KODIAK C2500, C3500, K2500, K3500.	1996/2000	131
7.5L	OLDSMOBILE DELTA, CUTLASS, VISTA.	1968/1974	*
8.1L	SILVERADO, 2500HD, 3500, SIERRA 2500, 3500, YUKON, SUBURBAN, AVALANCHE, EXPRESS VAN.	2001/2007	131

* Escanear código QR para consultar en catálogo electrónico o dirigase a catalogo.dcp.com.mx.

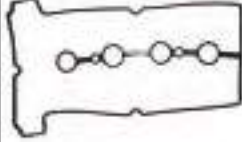

1.0L	MOTOR	MODELOS	DESDE / A	JUNTA DE CABEZA	MULTIPLE DE ADMISIÓN O PLENO
ENGINE	MODELS	FROM / TO	HEAD GASKET	INTAKE	
4L SOHC 8V DAEWOO ENGINE	MATIZ G2.	2004/2010	CA-116-G 	MS-4116 	
FS-116			MULTIPLE DE ESCAPE EXHAUST MS-4116-E 	PUNTERIAS VALVE COVER VS-3116-R 	CARTER OIL PAN
DISTRIBUCIÓN TIMING COVER TC-6116 	RETÉN CIGÜEÑAL CRANK SEAL BS-7116 	SELLOS DE VALVULA STEM SEALS SS-8116-R 	JUNTAS VARIAS MISCELLANEOUS N/A		

1.2L	MOTOR	MODELOS	DESDE / A	JUNTA DE CABEZA	MULTIPLE DE ADMISIÓN O PLENO
ENGINE	MODELS	FROM / TO	HEAD GASKET	INTAKE	
4L DOHC 16V	SPARK.	2011/2013	CA-119-ML 	MS-4119-A 	
FS-119-ML			MULTIPLE DE ESCAPE EXHAUST MS-4119-E 	PUNTERIAS VALVE COVER VS-3119-R 	CARTER OIL PAN
DISTRIBUCIÓN TIMING COVER TC-6119 	RETÉN CIGÜEÑAL CRANK SEAL BS-7116 	SELLOS DE VALVULA STEM SEALS SS-8119-V 	JUNTAS VARIAS MISCELLANEOUS N/A		



1.4L	MOTOR	MODELOS	DESDE / A	JUNTA DE CABEZA	MULTIPLE DE ADMISIÓN O PLENO		
ENGINE	MODELS	FROM / TO	HEAD GASKET	INTAKE			
4L SOHC 8V	CHEVY POP, JOY, SWING.	1994/2001	CA-100-G 	MS-4100 			
FS-100			MULTIPLE DE ESCAPE EXHAUST MS-4100-E 	PUNTERIAS VALVE COVER VS-3100 	CARTER OIL PAN OS-1100 		
DISTRIBUCIÓN		RETÉN CIGÜEÑAL		SELLOS DE VALVULA		JUNTAS VARIAS	N/A
TIMING COVER		CRANK SEAL		STEM SEALS		MISCELLANEOUS	
TC-6100		BS-7100		SS-8100-V		N/A	

1.6L	MOTOR	MODELOS	DESDE / A	JUNTA DE CABEZA	MULTIPLE DE ADMISIÓN O PLENO		
ENGINE	MODELS	FROM / TO	HEAD GASKET	INTAKE			
4L SOHC 8V	CHEVY MONZA, PICK-UP.	1996/2012	CA-100-1G 	MS-4100-1 			
FS-100-1			MULTIPLE DE ESCAPE EXHAUST MS-4100-E 	PUNTERIAS VALVE COVER VS-3100-1 	CARTER OIL PAN OS-1100 		
DISTRIBUCIÓN		RETÉN CIGÜEÑAL		SELLOS DE VALVULA		JUNTAS VARIAS	N/A
TIMING COVER		CRANK SEAL		STEM SEALS		MISCELLANEOUS	
TC-6100		BS-7100		SS-8100-V		N/A	



1.6L	MOTOR	MODELOS	DESDE / A	JUNTA DE CABEZA	MULTIPLE DE ADMISIÓN O PLENO
ENGINE	MODELS	FROM / TO	HEAD GASKET	INTAKE	
4L DOHC 16V VIN 6 E-TEC	AVEO, PONTIAC G3 (CABEZA DE GRAFITO).	2008/2012	CA-102-1G 	MS-4102-1A 	
FS-102-1G 			MULTIPLE DE ESCAPE EXHAUST MS-4102-1E 	PUNTERIAS VALVE COVER VS-3102-1R 	CARTER OIL PAN OS-1100
DISTRIBUCIÓN TIMING COVER TC-6102-1 	RETÉN CIGÜEÑAL CRANK SEAL BS-7100 	SELLOS DE VALVULA STEM SEALS SS-8102-1V 	JUNTAS VARIAS MISCELLANEOUS N/A	N/A	

1.6L	MOTOR	MODELOS	DESDE / A	JUNTA DE CABEZA	MULTIPLE DE ADMISIÓN O PLENO
ENGINE	MODELS	FROM / TO	HEAD GASKET	INTAKE	
4L DOHC 16V VIN 6 E-TEC	AVEO, PONTIAC G3 (CABEZA DE MLS).	2008/2012	CA-102-1ML 	MS-4102-1A 	
FS-102-1ML 			MULTIPLE DE ESCAPE EXHAUST MS-4102-1E 	PUNTERIAS VALVE COVER VS-3102-1R 	CARTER OIL PAN OS-1100
DISTRIBUCIÓN TIMING COVER TC-6102-1 	RETÉN CIGÜEÑAL CRANK SEAL BS-7100 	SELLOS DE VALVULA STEM SEALS SS-8102-1V 	JUNTAS VARIAS MISCELLANEOUS N/A	N/A	



1.8L	MOTOR	MODELOS	DESDE / A	JUNTA DE CABEZA	MULTIPLE DE ADMISIÓN O PLENO
ENGINE	MODELS	FROM / TO	HEAD GASKET	INTAKE	
4L SOHC 8V	CORSA, PICK-UP TORNADO.	2003/2006	CA-118-G 	MS-4100 	
FS-118 			MULTIPLE DE ESCAPE EXHAUST	PUNTERIAS VALVE COVER	CARTER OIL PAN
DISTRIBUCIÓN TIMING COVER		RETÉN CIGÜEÑAL CRANK SEAL		SELLOS DE VALVULA STEM SEALS	
TC-6100		BS-7100		SS-8100-V	JUNTAS VARIAS MISCELLANEOUS
					N/A







1.8L	MOTOR	MODELOS	DESDE / A	JUNTA DE CABEZA	MULTIPLE DE ADMISIÓN O PLENO
ENGINE	MODELS	FROM / TO	HEAD GASKET	INTAKE	
4L SOHC 8V	CORSA, PICK-UP TORNADO.	2007/2010	CA-118-G 	MS-4118 	
FS-118-1 			MULTIPLE DE ESCAPE EXHAUST	PUNTERIAS VALVE COVER	CARTER OIL PAN
DISTRIBUCIÓN TIMING COVER		RETÉN CIGÜEÑAL CRANK SEAL		SELLOS DE VALVULA STEM SEALS	
TC-6100		BS-7100		SS-8114-V	JUNTAS VARIAS MISCELLANEOUS
					N/A



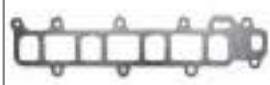







1.8L	MOTOR	MODELOS	DESDE / A	JUNTA DE CABEZA	MULTIPLE DE ADMISIÓN O PLENO
ENGINE	MODELS	FROM / TO	HEAD GASKET	INTAKE	
4L DOHC 16V MOTOR ECOTEC LUW	CRUZE (CABEZA DE GRAFITO).	2011/2013	CA-122-G 	MS-4122 	
FS-122-G 			MULTIPLE DE ESCAPE EXHAUST MS-4122-E 	PUNTERIAS VALVE COVER VS-3122-R 	CARTER OIL PAN N/A
DISTRIBUCIÓN TIMING COVER TC-6122 	RETÉN CIGÜEÑAL CRANK SEAL BS-7122-NT 	SELLOS DE VALVULA STEM SEALS SS-8122-V 	JUNTAS VARIAS MISCELLANEOUS N/A	N/A	

1.8L	MOTOR	MODELOS	DESDE / A	JUNTA DE CABEZA	MULTIPLE DE ADMISIÓN O PLENO
ENGINE	MODELS	FROM / TO	HEAD GASKET	INTAKE	
4L DOHC 16V MOTOR ECOTEC.	CRUZE, (CABEZA DE MLS).	2011/2013	CA-122-ML 	MS-4122 	
FS-122-ML 			MULTIPLE DE ESCAPE EXHAUST MS-4122-E 	PUNTERIAS VALVE COVER VS-3122-R 	CARTER OIL PAN N/A
DISTRIBUCIÓN TIMING COVER TC-6122 	RETÉN CIGÜEÑAL CRANK SEAL BS-7122-NT 	SELLOS DE VALVULA STEM SEALS SS-8122-V 	JUNTAS VARIAS MISCELLANEOUS N/A	N/A	

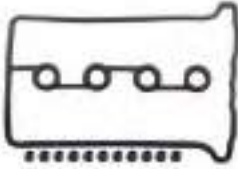

1.9L	MOTOR	MODELOS	DESDE / A	JUNTA DE CABEZA		MÚLTIPLE DE ADMISIÓN O PLENO
ENGINE	MODELS	FROM / TO	HEAD GASKET		INTAKE	
4L SOHC 8V 116" MFI VIN 8 9	SATURN SL, SL1, SC1, SW1.	1991/1995	CA-111-G 		MS-4111 	
FS-111-G 			MÚLTIPLE DE ESCAPE EXHAUST MS-4111-E 	PUNTERIAS VALVE COVER VS-3111-R 	CARTER OIL PAN N/A	
DISTRIBUCIÓN TIMING COVER TC-6115 	RETÉN CIGÜEÑAL CRANK SEAL BS-7115 	SELLOS DE VALVULA STEM SEALS SS-8111-S 	JUNTAS VARIAS MISCELLANEOUS N/A	N/A		

1.9L	MOTOR	MODELOS	DESDE / A	JUNTA DE CABEZA		MÚLTIPLE DE ADMISIÓN O PLENO
ENGINE	MODELS	FROM / TO	HEAD GASKET		INTAKE	
4L DOHC 16V 116" VIN 7.	SATURN SC, SC2, SL2, SW2.	1991/1995	CA-115-G 		MS-4115 	
FS-115 			MÚLTIPLE DE ESCAPE EXHAUST MS-4115-E 	PUNTERIAS VALVE COVER VS-3115-1R 	CARTER OIL PAN N/A	
DISTRIBUCIÓN TIMING COVER TC-6115 	RETÉN CIGÜEÑAL CRANK SEAL BS-7115 	SELLOS DE VALVULA STEM SEALS SS-8115-V 	JUNTAS VARIAS MISCELLANEOUS N/A	N/A		



2.0L	MOTOR	MODELOS	DESDE / A	JUNTA DE CABEZA	MULTIPLE DE ADMISIÓN O PLENO
ENGINE	MODELS	FROM / TO	HEAD GASKET	INTAKE	
4L OHV 8V 122"	CAVALIER USA, BERTTA, CORSICA.	1987/1991	CA-108-G 	MS-4108 	
FS-108 			MULTIPLE DE ESCAPE EXHAUST MS-4108-E 	PUNTERIAS VALVE COVER VS-3108-R 	CARTER OIL PAN OS-1108
DISTRIBUCIÓN TIMING COVER TC-6108 	RETÉN CIGÜEÑAL CRANK SEAL BS-7140-R 	SELLOS DE VALVULA STEM SEALS SS-8108-V 	JUNTAS VARIAS MISCELLANEOUS 		

2.2L	MOTOR	MODELOS	DESDE / A	JUNTA DE CABEZA	MULTIPLE DE ADMISIÓN O PLENO
ENGINE	MODELS	FROM / TO	HEAD GASKET	INTAKE	
4L SOHC 8V MOTOR ISUZU	MEXICO PICK-UP LUV PONTIAC BRASIL.	1998/2005	CA-107-G 	MS-4107-1 	
FS-107-1 			MULTIPLE DE ESCAPE EXHAUST MS-4107-E 	PUNTERIAS VALVE COVER VS-3107 	CARTER OIL PAN OS-1107-1
DISTRIBUCIÓN TIMING COVER TC-6107-1 	RETÉN CIGÜEÑAL CRANK SEAL BS-7107-1 	SELLOS DE VALVULA STEM SEALS SS-8100-V 	JUNTAS VARIAS MISCELLANEOUS N/A		



2.2L	MOTOR	MODELOS	DESDE / A	JUNTA DE CABEZA		MÚLTIPLE DE ADMISIÓN O PLENO
ENGINE	MODELS	FROM / TO	HEAD GASKET		INTAKE	
4L OHV 8V 134"	CAVALIER USA, BERETTA, CORSICA.	1990/1991	CA-108-G		MS-4108	
DISTRIBUCIÓN		RETÉN CIGÜEÑAL	SELLOS DE VALVULA		JUNTAS VARIAS	
TIMING COVER		CRANK SEAL	STEM SEALS		MISCELLANEOUS	
TC-6108		BS-7140-R	SS-8108-V			





2.2L	MOTOR	MODELOS	DESDE / A	JUNTA DE CABEZA		MÚLTIPLE DE ADMISIÓN O PLENO
ENGINE	MODELS	FROM / TO	HEAD GASKET		INTAKE	
4L OHV 8V 134"	CAVALIER AMERICANO, CUTTLAS, CENTURY.	1992/1993	CA-108-G		MS-4108-1	
DISTRIBUCIÓN		RETÉN CIGÜEÑAL	SELLOS DE VALVULA		JUNTAS VARIAS	N/A
TIMING COVER		CRANK SEAL	STEM SEALS		MISCELLANEOUS	
TC-6108		BS-7140-R	SS-8140-12P		N/A	



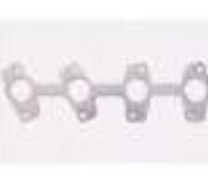
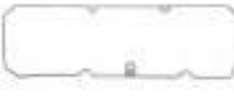

2.2L	MOTOR	MODELOS	DESDE / A	JUNTA DE CABEZA	MULTIPLE DE ADMISIÓN O PLENO
ENGINE	MODELS	FROM / TO	HEAD GASKET	INTAKE	
4L OHV 8V 134"	CAVALIER, BUICK CENTURY, PONTIAC SUNFIRE SE.	1994/1997	CA-108-G 	MS-4108-1 	
FS-108-2 			MULTIPLE DE ESCAPE EXHAUST MS-4108-E 	PUNTERIAS VALVE COVER VS-3108-R 	CARTER OIL PAN OS-1108
DISTRIBUCIÓN TIMING COVER TC-6108 	RETÉN CIGÜEÑAL CRANK SEAL BS-7140-R 	SELLOS DE VALVULA STEM SEALS SS-8108-V 	JUNTAS VARIAS MISCELLANEOUS N/A	N/A	

2.2L	MOTOR	MODELOS	DESDE / A	JUNTA DE CABEZA	MULTIPLE DE ADMISIÓN O PLENO
ENGINE	MODELS	FROM / TO	HEAD GASKET	INTAKE	
4L OHV 8V 134"	PICK UP S-10, SONOMA, ISUZU HOMBRE.	1994/1997	CA-112-G 	MS-4108-1 	
FS-112 			MULTIPLE DE ESCAPE EXHAUST MS-4108-E 	PUNTERIAS VALVE COVER VS-3108-R 	CARTER OIL PAN OS-1108
DISTRIBUCIÓN TIMING COVER TC-6108 	RETÉN CIGÜEÑAL CRANK SEAL BS-7140-R 	SELLOS DE VALVULA STEM SEALS SS-8108-V 	JUNTAS VARIAS MISCELLANEOUS 	N/A	

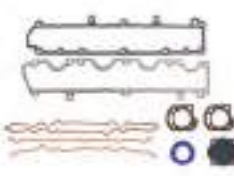
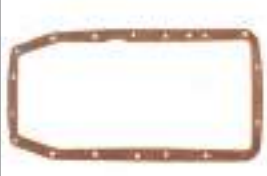

2.2L	MOTOR	MODELOS	DESDE / A	JUNTA DE CABEZA		MÚLTIPLE DE ADMISIÓN O PLENO
ENGINE	MODELS	FROM / TO	HEAD GASKET		INTAKE	
4L OHV 8V 134" VIN 4	CAVALIER, S-10, SONOMA.	1998/2002	CA-112-G 		MS-4112 	
FS-112-1			MÚLTIPLE DE ESCAPE EXHAUST MS-4112-E 		PUNTERIAS VALVE COVER VS-3112-R 	CARTER OIL PAN OS-1108 
DISTRIBUCIÓN TIMING COVER	RETÉN CIGÜEÑAL CRANK SEAL	SELLOS DE VALVULA STEM SEALS	JUNTAS VARIAS MISCELLANEOUS		N/A	
TC-6108	BS-7140-R	SS-8112-V	N/A		N/A	

2.3L	MOTOR	MODELOS	DESDE / A	JUNTA DE CABEZA		MÚLTIPLE DE ADMISIÓN O PLENO
ENGINE	MODELS	FROM / TO	HEAD GASKET		INTAKE	
4L DOHC 16V QUAD4 VIN A, D.	BERETTA, PONTIAC GRAND AM, GRAND PRIX, CLUTLASS, SKYLARK.	1987/1991	CA-109-G 		MS-4109 	
FS-109			MÚLTIPLE DE ESCAPE EXHAUST MS-4109-1E 		PUNTERIAS VALVE COVER VS-3109-1R 	CARTER OIL PAN OS-1109 
DISTRIBUCIÓN TIMING COVER	RETÉN CIGÜEÑAL CRANK SEAL	SELLOS DE VALVULA STEM SEALS	JUNTAS VARIAS MISCELLANEOUS		N/A	
TC-6109-3	BS-7109	SS-8109-1V	N/A		N/A	



2.4L	MOTOR	MODELOS	DESDE / A	JUNTA DE CABEZA	MULTIPLE DE ADMISIÓN O PLENO
ENGINE	MODELS	FROM / TO	HEAD GASKET	INTAKE	
4L DOHC 16V VIN T.	PONTIAC SUNFIRE, GRAND AM, CAVALIER, MALIBU.	1997/2002	CA-109-1G 	MS-4109-1NS 	
FS-109-1 			MULTIPLE DE ESCAPE EXHAUST MS-4109-E 	PUNTERIAS VALVE COVER VS-3109-2R 	CARTER OIL PAN OS-1109-1
DISTRIBUCIÓN TIMING COVER TC-6109 	RETÉN CIGÜEÑAL CRANK SEAL BS-7109 	SELLOS DE VALVULA STEM SEALS SS-8109-1V 	JUNTAS VARIAS MISCELLANEOUS N/A	N/A	

2.5L	MOTOR	MODELOS	DESDE / A	JUNTA DE CABEZA	MULTIPLE DE ADMISIÓN O PLENO
ENGINE	MODELS	FROM / TO	HEAD GASKET	INTAKE	
4L OHV 8V 151" VIN E	S10, ASTRO, CELEBRITY, S15, SAFARI, CUTLASS.	1988/1990	CA-105-G 	MS-4105-1 	
FS-105-2 			MULTIPLE DE ESCAPE EXHAUST MS-4105-1E 	PUNTERIAS VALVE COVER VS-3105-2 	CARTER OIL PAN OS-1105
DISTRIBUCIÓN TIMING COVER TC-6130 	RETÉN CIGÜEÑAL CRANK SEAL BS-7105 	SELLOS DE VALVULA STEM SEALS SS-8105-V 	JUNTAS VARIAS MISCELLANEOUS N/A	N/A	



2.5L	MOTOR	MODELOS	DESDE / A	JUNTA DE CABEZA		MÚLTIPLE DE ADMISIÓN O PLENO
ENGINE	MODELS	FROM / TO	HEAD GASKET		INTAKE	
4L OHV 8V 151" VIN A R	CELEBRITY, CENTURY, CUTLASS, SONOMA, S10, LUMINA.	1990/1993	CA-105-G		MS-4105-3	
FS-105-3						
			MÚLTIPLE DE ESCAPE	PUNTERIAS	CARTER	
			EXHAUST	VALVE COVER	OIL PAN	
			MS-4105-1E	VS-3105-2	OS-1105	
DISTRIBUCIÓN		RETÉN CIGÜEÑAL	SELLOS DE VALVULA	JUNTAS VARIAS	N/A	
TIMING COVER		CRANK SEAL	STEM SEALS	MISCELLANEOUS		
TC-6130		BS-7105	SS-8105-V	N/A		

2.8L	MOTOR	MODELOS	DESDE / A	JUNTA DE CABEZA		MÚLTIPLE DE ADMISIÓN O PLENO
ENGINE	MODELS	FROM / TO	HEAD GASKET		INTAKE	
4L DOHC 169" 16V VIN 8 MOTOR LK5 16V VIN 8	COLORADO, CANYON.	2004/2006	CA-126-ML		MS-4126	
FS-126-ML						
			MÚLTIPLE DE ESCAPE	PUNTERIAS	CARTER	
			EXHAUST	VALVE COVER	OIL PAN	
			MS-4126-E			
DISTRIBUCIÓN		RETÉN CIGÜEÑAL	SELLOS DE VALVULA	JUNTAS VARIAS		
TIMING COVER		CRANK SEAL	STEM SEALS	MISCELLANEOUS		
TC-6153-1		BS-7126-T				



2.8L	MOTOR	MODELOS	DESDE / A	JUNTA DE CABEZA		MÚLTIPLE DE ADMISIÓN O PLENO	
ENGINE	MODELS	FROM / TO	HEAD GASKET		INTAKE		
V6 OHV 12V 173" VIN B X Z 1 7	CELEBRITY, CITATION, S10, PONTIAC FIREBIRD.	1980/1984	CA-140-G		MS-4140-A		
FS-140-1			MÚLTIPLE DE ESCAPE		PUNTERIAS	CARTER	
			EXHAUST		VALVE COVER	OIL PAN	
			MS-4140-E	VS-3140	OS-1140-1C		
DISTRIBUCIÓN		RETÉN CIGÜEÑAL		SELLOS DE VALVULA		JUNTAS VARIAS	
TIMING COVER		CRANK SEAL		STEM SEALS		MISCELLANEOUS	
TC-6140		BS-7140-1R		SS-8140-12P			

2.8L	MOTOR	MODELOS	DESDE / A	JUNTA DE CABEZA		MÚLTIPLE DE ADMISIÓN O PLENO	
ENGINE	MODELS	FROM / TO	HEAD GASKET		INTAKE		
V6 OHV 12V 173" VIN W	CUTLASS, CAVALIER, CELEBRITY, CITATION, COMANCHE, WAGONEER.	1985/1986	CA-140-G		MS-4140-A		
FS-140-2			MÚLTIPLE DE ESCAPE		PUNTERIAS	CARTER	
			EXHAUST		VALVE COVER	OIL PAN	
			MS-4140-E	VS-3140-1	OS-1140-1C		
DISTRIBUCIÓN		RETÉN CIGÜEÑAL		SELLOS DE VALVULA		JUNTAS VARIAS	
TIMING COVER		CRANK SEAL		STEM SEALS		MISCELLANEOUS	
TC-6140		BS-7140-R		SS-8141-V			



2.8L	MOTOR	MODELOS	DESDE / A	JUNTA DE CABEZA	MULTIPLE DE ADMISIÓN O PLENO
ENGINE	MODELS	FROM / TO	HEAD GASKET	INTAKE	
V6 OHV 12V 173" VIN R	CAMIONETA S-10, SONOMA, CELEBRITY.	1987/1993	CA-140-G	MS-4140-A	
FS-140-4					
			MULTIPLE DE ESCAPE	PUNTERIAS	CARTER
DISTRIBUCIÓN			EXHAUST	VALVE COVER	OIL PAN
TIMING COVER			MS-4140-E	VS-3140-1	OS-1140-1R
TC-6140-1		RETÉN CIGÜEÑAL			
		CRANK SEAL	SELLOS DE VALVULA	JUNTAS VARIAS	
	BS-7140-R		STEM SEALS	MISCELLANEOUS	
			SS-8140-12P		

2.8L	MOTOR	MODELOS	DESDE / A	JUNTA DE CABEZA	MULTIPLE DE ADMISIÓN O PLENO
ENGINE	MODELS	FROM / TO	HEAD GASKET	INTAKE	
V6 OHV 12V	MPFI 2a GENERACION, CAVALIER, CUTLASS, EUROSPORT, CENTURY.	1988/1994	CA-141-G	MS-4141-A	
FS-141					
			MULTIPLE DE ESCAPE	PUNTERIAS	CARTER
DISTRIBUCIÓN			EXHAUST	VALVE COVER	OIL PAN
TIMING COVER			MS-4141-E	VS-3141-R	OS-1140-1R
TC-6140-1		RETÉN CIGÜEÑAL			
		CRANK SEAL	SELLOS DE VALVULA	JUNTAS VARIAS	
	BS-7140-R		STEM SEALS	MISCELLANEOUS	
			SS-8141-V		



3.1L	MOTOR	MODELOS	DESDE / A	JUNTA DE CABEZA	MULTIPLE DE ADMISIÓN O PLENO	
ENGINE	MODELS	FROM / TO	HEAD GASKET	INTAKE		
V6 OHV 12V VIN T	CAVALIER, CUT-LASS, CENTURY.	1988/1995	CA-141-G 	MS-4141-A 		
FS-141						
DISTRIBUCIÓN		RETÉN CIGÜEÑAL		MULTIPLE DE ESCAPE	PUNTERIAS	CARTER
TIMING COVER		CRANK SEAL		EXHAUST	VALVE COVER	OIL PAN
TC-6140-1		BS-7140-R	SS-8141-V 	MS-4141-E 	VS-3141-R 	OS-1140-1R
				JUNTAS VARIAS	N/A	
				MISCELLANEOUS	N/A	





3.1L	MOTOR	MODELOS	DESDE / A	JUNTA DE CABEZA	MULTIPLE DE ADMISIÓN O PLENO	
ENGINE	MODELS	FROM / TO	HEAD GASKET	INTAKE		
V6 OHV 12V 189" VIN J	LUMINA SEDAN, MALIBU.	2000/2003	CA-145-G 	MS-4145-2 		
FS-145-1						
DISTRIBUCIÓN		RETÉN CIGÜEÑAL		MULTIPLE DE ESCAPE	PUNTERIAS	CARTER
TIMING COVER		CRANK SEAL		EXHAUST	VALVE COVER	OIL PAN
TC-6140-1		BS-7140-R	SS-8145-V 	MS-4145-E 	VS-3145-R 	OS-1145-R
				JUNTAS VARIAS	N/A	
				MISCELLANEOUS	N/A	





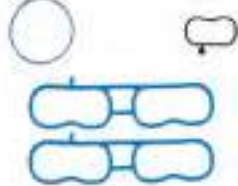

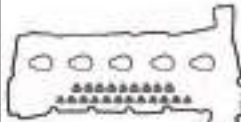

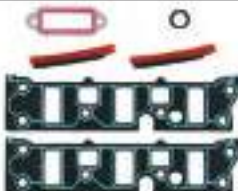

3.1L	MOTOR	MODELOS	DESDE / A	JUNTA DE CABEZA	MULTIPLE DE ADMISIÓN O PLENO
ENGINE	MODELS	FROM / TO	HEAD GASKET	INTAKE	
V6 OHV 12V 189" VIN M	CENTURY, LUMINA, MALIBU, GRAND PRIX.	1995/1999	CA-145-G 	MS-4145-2 	
FS-145-2 			MULTIPLE DE ESCAPE EXHAUST	PUNTERIAS VALVE COVER	CARTER OIL PAN
			MS-4145-E 	VS-3145-R 	OS-1145-R
DISTRIBUCIÓN TIMING COVER		RETÉN CIGÜEÑAL CRANK SEAL		SELLOS DE VALVULA STEM SEALS	
TC-6140-1		BS-7140-R		SS-8145-V	JUNTAS VARIAS MISCELLANEOUS
					N/A

3.4L	MOTOR	MODELOS	DESDE / A	JUNTA DE CABEZA	MULTIPLE DE ADMISIÓN O PLENO
ENGINE	MODELS	FROM / TO	HEAD GASKET	INTAKE	
V6 OHV 12V VIN E.	VENTURE, IMPALA, MONTE CARLO, TRANS SPORT, AZTEK, GRAND AM.	1996/2003	CA-173-G 	MS-4145-2 	
FS-173-1 			MULTIPLE DE ESCAPE EXHAUST	PUNTERIAS VALVE COVER	CARTER OIL PAN
			MS-4145-E 	VS-3145-R 	OS-1145-R
DISTRIBUCIÓN TIMING COVER		RETÉN CIGÜEÑAL CRANK SEAL		SELLOS DE VALVULA STEM SEALS	
TC-6140-1		BS-7140-R		SS-8145-V	JUNTAS VARIAS MISCELLANEOUS



3.5L	MOTOR	MODELOS	DESDE / A	JUNTA DE CABEZA	MULTIPLE DE ADMISIÓN O PLENO
ENGINE	MODELS	FROM / TO	HEAD GASKET	INTAKE	
5L DOHC 20 V 211" VIN 6	COLORADO, CANYON, H3, i-350.	2004/2006	CA-128-ML 	MS-4128 	
FS-128-ML 			MULTIPLE DE ESCAPE EXHAUST MS-4154-E 	PUNTERIAS VALVE COVER VS-3154-R 	CARTER OIL PAN
DISTRIBUCIÓN TIMING COVER		RETÉN CIGÜEÑAL CRANK SEAL BS-7126-1 	SELLOS DE VALVULA STEM SEALS	JUNTAS VARIAS MISCELLANEOUS	

3.8L	MOTOR	MODELOS	DESDE / A	JUNTA DE CABEZA	MULTIPLE DE ADMISIÓN O PLENO
ENGINE	MODELS	FROM / TO	HEAD GASKET	INTAKE	
V6 OHV 12V 231" VIN K	GRAND PRIX, MONTE CARLO, LUMINA, IMPALA, BONNEVILLE.	1997/2005	CA-148-G y CA-149-G PARA VER IMAGEN DIRIGIRSE A SECCIÓN DE JUNTAS DE CABEZA. TO SEE IMAGE GO TO SECTION HEAD GASKETS	MS-4148-NS1 	
FS-148 			MULTIPLE DE ESCAPE EXHAUST MS-4148-E 	PUNTERIAS VALVE COVER VS-3148-R 	CARTER OIL PAN OS-1148-R 
DISTRIBUCIÓN TIMING COVER TC-6148 		RETÉN CIGÜEÑAL CRANK SEAL BS-7148 	SELLOS DE VALVULA STEM SEALS SS-8141-V 	JUNTAS VARIAS MISCELLANEOUS N/A	N/A



4.1L	MOTOR	MODELOS	DESDE / A	JUNTA DE CABEZA	MÚLTIPLE DE ADMISIÓN O PLENO
ENGINE	MODELS	FROM / TO	HEAD GASKET	INTAKE	
6L OHV 12V	AUTOS Y CAMIONES CARBURADOS & TBI.	1963/1992	CA-130-G 	MS-4130-1 	
FS-130 			MÚLTIPLE DE ESCAPE EXHAUST ** N/A ** N/A	PUNTERIAS VALVE COVER VS-3130 	CARTER OIL PAN OS-1130
DISTRIBUCIÓN TIMING COVER TC-6130 	RETÉN CIGÜEÑAL CRANK SEAL BS-7130-2 	SELLOS DE VALVULA STEM SEALS SS-8110 	JUNTAS VARIAS MISCELLANEOUS 		

4.2L	MOTOR	MODELOS	DESDE / A	JUNTA DE CABEZA	MÚLTIPLE DE ADMISIÓN O PLENO
ENGINE	MODELS	FROM / TO	HEAD GASKET	INTAKE	
6L DOHC 24V 256" MOTOR VORTEC VIN S	TRAILBLAZER, ENVOY, ASCENDER, BRAVADA (CABEZA DE GRAFITO).	2002/2006	CA-153-G 	MS-4153 	
FS-153 			MÚLTIPLE DE ESCAPE EXHAUST MS-4153-E 	PUNTERIAS VALVE COVER VS-3153-R 	CARTER OIL PAN N/A
DISTRIBUCIÓN TIMING COVER TC-6153 	RETÉN CIGÜEÑAL CRANK SEAL BS-7153-NT 	SELLOS DE VALVULA STEM SEALS SS-8153-V 	JUNTAS VARIAS MISCELLANEOUS N/A		



4.3L	MOTOR	MODELOS	DESDE / A	JUNTA DE CABEZA	MULTIPLE DE ADMISIÓN O PLENO
ENGINE	MODELS	FROM / TO	HEAD GASKET	INTAKE	
V6 OHV 12V VIN Z	ASTRO, PICKUP C10, C20, C1500, C2500, SAFARI, CAPRICE, EL CAMINO.	1985/1990	CA-144-G 	MS-4144 	
FS-144 			MULTIPLE DE ESCAPE EXHAUST	PUNTERIAS VALVE COVER	CARTER OIL PAN
			MS-4144-E 	VS-3144 	OS-1143
DISTRIBUCIÓN TIMING COVER		RETÉN CIGÜEÑAL CRANK SEAL		SELLOS DE VALVULA STEM SEALS	
TC-6150-5		BS-7130-2		SS-8140-12P 	JUNTAS VARIAS MISCELLANEOUS

4.3L	MOTOR	MODELOS	DESDE / A	JUNTA DE CABEZA	MULTIPLE DE ADMISIÓN O PLENO
ENGINE	MODELS	FROM / TO	HEAD GASKET	INTAKE	
V6 OHV 12V TBI VIN W Z	ASTRO, PICK UP S10, S15, C1500, C2500, G10, G20, G30, JIMMY, SAFARI (MOTOR TBI).	1986/1992	CA-144-G 	MS-4144-1 	
FS-144-1 			MULTIPLE DE ESCAPE EXHAUST	PUNTERIAS VALVE COVER	CARTER OIL PAN
			MS-4144-E 	VS-3144 	OS-1144-R
DISTRIBUCIÓN TIMING COVER		RETÉN CIGÜEÑAL CRANK SEAL		SELLOS DE VALVULA STEM SEALS	
TC-6150-5		BS-7160		SS-8140-12P 	JUNTAS VARIAS MISCELLANEOUS N/A



4.3L	MOTOR	MODELOS	DESDE / A	JUNTA DE CABEZA	MULTIPLE DE ADMISIÓN O PLENO	
ENGINE	MODELS	FROM / TO	HEAD GASKET	INTAKE		
V6 OHV 12V VIN VIN B W Z	ASTRO, SAFARI.	1986/1992	CA-144-G 	MS-4144-1 		
FS-144-2 			MULTIPLE DE ESCAPE EXHAUST	PUNTERIAS VALVE COVER	CARTER OIL PAN	
			MS-4144-E 	VS-3144-R 	OS-1144-R 	
DISTRIBUCIÓN TIMING COVER		RETÉN CIGÜEÑAL CRANK SEAL		SELLOS DE VALVULA STEM SEALS	JUNTAS VARIAS MISCELLANEOUS	N/A
TC-6150-5		BS-7160	SS-8140-12P 			

4.3L	MOTOR	MODELOS	DESDE / A	JUNTA DE CABEZA	MULTIPLE DE ADMISIÓN O PLENO	
ENGINE	MODELS	FROM / TO	HEAD GASKET	INTAKE		
V6 OHV 12V VIN W Z	SONOMA, S-10, S-15, ASTRO, SAFARI, C1500, C2500, K1500, K2500.	1993	CA-144-G 	MS-4144-2 		
FS-144-3 			MULTIPLE DE ESCAPE EXHAUST	PUNTERIAS VALVE COVER	CARTER OIL PAN	
			MS-4144-E 	VS-3144 	OS-1144-R 	
DISTRIBUCIÓN TIMING COVER		RETÉN CIGÜEÑAL CRANK SEAL		SELLOS DE VALVULA STEM SEALS	JUNTAS VARIAS MISCELLANEOUS	N/A
TC-6150-5		BS-7160	SS-8140-12P 			



4.3L	MOTOR	MODELOS	DESDE / A	JUNTA DE CABEZA	MULTIPLE DE ADMISIÓN O PLENO
ENGINE	MODELS	FROM / TO	HEAD GASKET	INTAKE	
V6 OHV 12V VIN W Z	ASTRO, SAFARI, SONOMA, C1500, C2500, G1500, G2500, G3500, JIMMY.	1994/1995	CA-144-G 	MS-4144-2 	
FS-144-4 			MULTIPLE DE ESCAPE EXHAUST MS-4144-E 	PUNTERIAS VALVE COVER VS-3144-1R 	CARTER OIL PAN OS-1144-R
DISTRIBUCIÓN TIMING COVER TC-6150-5 	RETÉN CIGÜEÑAL CRANK SEAL BS-7160 	SELLOS DE VALVULA STEM SEALS SS-8140-12P 	JUNTAS VARIAS MISCELLANEOUS N/A	N/A	

4.3L	MOTOR	MODELOS	DESDE / A	JUNTA DE CABEZA	MULTIPLE DE ADMISIÓN O PLENO
ENGINE	MODELS	FROM / TO	HEAD GASKET	INTAKE	
V6 OHV 12V VIN W VOR-TEC	ASTRO, S10, BLAZER, SAFARI, SONOMA, S-15, JIMMY.	1992/1993	CA-144-G 	MS-4144-3 	
FS-144-5 			MULTIPLE DE ESCAPE EXHAUST MS-4144-E 	PUNTERIAS VALVE COVER VS-3144 	CARTER OIL PAN OS-1144-R
DISTRIBUCIÓN TIMING COVER TC-6144 	RETÉN CIGÜEÑAL CRANK SEAL BS-7160 	SELLOS DE VALVULA STEM SEALS SS-8140-12P 	JUNTAS VARIAS MISCELLANEOUS N/A	N/A	



4.3L	MOTOR	MODELOS	DESDE / A	JUNTA DE CABEZA	MULTIPLE DE ADMISIÓN O PLENO
ENGINE	MODELS	FROM / TO	HEAD GASKET	INTAKE	
V6 OHV 12V VIN W Z VORTEC	ASTRO, SAFARI, S-10, BLAZER, JIMMY.	1994/1995	CA-144-G 	MS-4144-3 	
FS-144-6 			MULTIPLE DE ESCAPE EXHAUST	PUNTERIAS VALVE COVER	CARTER OIL PAN
			MS-4144-E 	VS-3144-1R 	OS-1144-R
DISTRIBUCIÓN TIMING COVER		RETÉN CIGÜEÑAL CRANK SEAL		SELLOS DE VALVULA STEM SEALS	
TC-6144		BS-7160		SS-8140-12P	JUNTAS VARIAS MISCELLANEOUS
					N/A

4.3L	MOTOR	MODELOS	DESDE / A	JUNTA DE CABEZA	MULTIPLE DE ADMISIÓN O PLENO
ENGINE	MODELS	FROM / TO	HEAD GASKET	INTAKE	
V6 OHV 12V VIN VIN W X MOTOR VORTEC	SAFARI, ASTRO, SONOMA, S-10, JIMMY, SAVANA 1500, SIERRA 1500, SILVERADO 1500, SONORA, EXPRESS VAN, C1500.	1996/2011	CA-144-G 	MS-4144-4 	
FS-144-7 			MULTIPLE DE ESCAPE EXHAUST	PUNTERIAS VALVE COVER	CARTER OIL PAN
			MS-4144-1E 	VS-3144-1R 	OS-1144-1R
DISTRIBUCIÓN TIMING COVER		RETÉN CIGÜEÑAL CRANK SEAL		SELLOS DE VALVULA STEM SEALS	
TC-6150-5		BS-7160		SS-8160-12V	JUNTAS VARIAS MISCELLANEOUS
					N/A



4.3L	MOTOR	MODELOS	DESDE / A	JUNTA DE CABEZA	MULTIPLE DE ADMISIÓN O PLENO
ENGINE	MODELS	FROM / TO	HEAD GASKET	INTAKE	
V8 V8 OHV 16V 265" MOTOR VORTEC	CAPRICE.	1994/1996	CA-151-G 	MS-4151 	
FS-151 			MULTIPLE DE ESCAPE EXHAUST MS-4151-E 	PUNTERIAS VALVE COVER VS-3150-1R 	CARTER OIL PAN OS-1150-1R
DISTRIBUCIÓN TIMING COVER TC-6150-6 	RETÉN CIGÜEÑAL CRANK SEAL BS-7160 	SELLOS DE VALVULA STEM SEALS SS-8160-16V 	JUNTAS VARIAS MISCELLANEOUS N/A	N/A	

4.8L	MOTOR	MODELOS	DESDE / A	JUNTA DE CABEZA	MULTIPLE DE ADMISIÓN O PLENO
ENGINE	MODELS	FROM / TO	HEAD GASKET	INTAKE	
6L OHV 12V	AUTOS Y CAMIONES CARBURADOS & TBI.	1963/1992	CA-130-G 	MS-4130-1 	
FS-130 			MULTIPLE DE ESCAPE EXHAUST N/A	PUNTERIAS VALVE COVER VS-3130 	CARTER OIL PAN OS-1130
DISTRIBUCIÓN TIMING COVER TC-6130 	RETÉN CIGÜEÑAL CRANK SEAL BS-7130-2 	SELLOS DE VALVULA STEM SEALS SS-8110 	JUNTAS VARIAS MISCELLANEOUS		



4.8L	MOTOR	MODELOS	DESDE / A	JUNTA DE CABEZA	MULTIPLE DE ADMISIÓN O PLENO
ENGINE	MODELS	FROM / TO	HEAD GASKET	INTAKE	
V8 OHV 16V VORTEC VIN VT	CHEYENNE, SILVERADO 1500, 2500, SUBURBAN, YUKON, SIERRA 1500, 2500, TAHOE (CABEZAS DE GRAFITO).	1999/2001	CA-175-G 	MS-4175-NS 	
FS-175-G			MULTIPLE DE ESCAPE EXHAUST MS-4175-E 	PUNTERIAS VALVE COVER VS-3175-R 	CARTER OIL PAN OS-1175
DISTRIBUCIÓN TIMING COVER TC-6175 	RETÉN CIGÜEÑAL CRANK SEAL BS-7175-NT 	SELLOS DE VALVULA STEM SEALS SS-8152-V 	JUNTAS VARIAS MISCELLANEOUS N/A		

4.8L	MOTOR	MODELOS	DESDE / A	JUNTA DE CABEZA	MULTIPLE DE ADMISIÓN O PLENO
ENGINE	MODELS	FROM / TO	HEAD GASKET	INTAKE	
V8 OHV 16V VIN TV	CHEYENNE, SILVERADO 1500, 2500, SUBURBAN, YUKON, SIERRA 1500, 2500, TAHOE (CABEZAS DE MLS).	1999/2001	CA-175-ML 	MS-4175-NS 	
FS-175-ML			MULTIPLE DE ESCAPE EXHAUST MS-4175-E 	PUNTERIAS VALVE COVER VS-3175-R 	CARTER OIL PAN OS-1175-1R
DISTRIBUCIÓN TIMING COVER TC-6175-LS 	RETÉN CIGÜEÑAL CRANK SEAL BS-7175-NT 	SELLOS DE VALVULA STEM SEALS SS-8152-V 	JUNTAS VARIAS MISCELLANEOUS N/A		



4.8L	MOTOR	MODELOS	DESDE / A	JUNTA DE CABEZA	MULTIPLE DE ADMISIÓN O PLENO
ENGINE	MODELS	FROM / TO	HEAD GASKET	INTAKE	
V8 OHV 16V VORTEC VIN T Z V	SUBURBAN, SILVERADO 1500, 2500, SIERRA 1500, 2500, YUKON, AVALANCHE, SAVANA, EXPRESS VAN 1500, 2500, SONORA.	2002/2009	CA-175-G 	MS-4175-1NS 	
FS-175-1G 			MULTIPLE DE ESCAPE EXHAUST MS-4175-E 	PUNTERIAS VALVE COVER VS-3175-R 	CARTER OIL PAN OS-1175
DISTRIBUCIÓN TIMING COVER TC-6175 	RETÉN CIGÜEÑAL CRANK SEAL BS-7175-NT 	SELLOS DE VALVULA STEM SEALS SS-8152-1V 	JUNTAS VARIAS MISCELLANEOUS N/A	N/A	

5.0L	MOTOR	MODELOS	DESDE / A	JUNTA DE CABEZA	MULTIPLE DE ADMISIÓN O PLENO
ENGINE	MODELS	FROM / TO	HEAD GASKET	INTAKE	
V8 OHV 16V 305" VORTEC VIN M	EXPRESS VAN 1500, 2500, C1500, C2500, K1500, K500, SAVANA.	1996/2002	CA-160-G 	MS-4150-9 	
FS-160-2 			MULTIPLE DE ESCAPE EXHAUST MS-4150-2E 	PUNTERIAS VALVE COVER VS-3150-1R 	CARTER OIL PAN OS-1150-1R
DISTRIBUCIÓN TIMING COVER TC-6150-5 	RETÉN CIGÜEÑAL CRANK SEAL BS-7160-1T 	SELLOS DE VALVULA STEM SEALS SS-8160-16V 	JUNTAS VARIAS MISCELLANEOUS N/A	N/A	



5.0L	MOTOR	MODELOS	DESDE / A	JUNTA DE CABEZA	MULTIPLE DE ADMISIÓN O PLENO		
ENGINE	MODELS	FROM / TO	HEAD GASKET	INTAKE			
V8 OHV 16V 305" VIN H, E, Y, 9	CAPRICE, MONTE CARLO, C1500, C2500, CAMARO, PONTIAC GRAND PRIX, FIREBIRD, MOTOR TBI.	1987/1995	CA-160-G 	MS-4150-6 			
FS-160-5			MULTIPLE DE ESCAPE EXHAUST	PUNTERIAS VALVE COVER	CARTER OIL PAN		
			MS-4150-E 	VS-3150-1R 	OS-1150-1R 		
DISTRIBUCIÓN TIMING COVER		RETÉN CIGÜEÑAL CRANK SEAL		SELLOS DE VALVULA STEM SEALS		JUNTAS VARIAS MISCELLANEOUS	
TC-6150-5		BS-7160		SS-8140-16P	N/A	N/A	





5.0L	MOTOR	MODELOS	DESDE / A	JUNTA DE CABEZA	MULTIPLE DE ADMISIÓN O PLENO		
ENGINE	MODELS	FROM / TO	HEAD GASKET	INTAKE			
V8 OHV 16V 305" VORTEC VIN F H	CAMARO, FIRE-BIRD.	1987/1992	CA-160-G 	MS-4150-6 			
FS-160-6			MULTIPLE DE ESCAPE EXHAUST	PUNTERIAS VALVE COVER	CARTER OIL PAN		
			MS-4150-E 	VS-3150-1R 	OS-1150-1R 		
DISTRIBUCIÓN TIMING COVER		RETÉN CIGÜEÑAL CRANK SEAL		SELLOS DE VALVULA STEM SEALS		JUNTAS VARIAS MISCELLANEOUS	
TC-6150-5		BS-7160		SS-8140-16P	N/A	N/A	





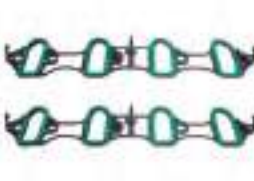

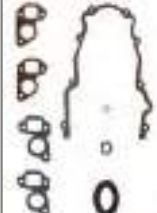
5.3L	MOTOR	MODELOS	DESDE / A	JUNTA DE CABEZA	MULTIPLE DE ADMISIÓN O PLENO
ENGINE	MODELS	FROM / TO	HEAD GASKET	INTAKE	
V8 OHV 16V VIN VT	CHEYENNE, SILVERADO 1500, 2500, SUBURBAN, YUKON, SIERRA 1500, 2500, TAHOE (CABEZAS DE GRAFITO).	1999/2001	CA-175-G 	MS-4175-NS 	
FS-175-G 			MULTIPLE DE ESCAPE EXHAUST MS-4175-E 	PUNTERIAS VALVE COVER VS-3175-R 	CARTER OIL PAN OS-1175
DISTRIBUCIÓN TIMING COVER TC-6175 	RETÉN CIGÜEÑAL CRANK SEAL BS-7175-NT 	SELLOS DE VALVULA STEM SEALS SS-8152-V 	JUNTAS VARIAS MISCELLANEOUS N/A	N/A	

5.3L	MOTOR	MODELOS	DESDE / A	JUNTA DE CABEZA	MULTIPLE DE ADMISIÓN O PLENO
ENGINE	MODELS	FROM / TO	HEAD GASKET	INTAKE	
V8 OHV 16V VIN TV	CHEYENNE, SILVERADO 1500, 2500, SUBURBAN, YUKON, SIERRA 1500, 2500, TAHOE (CABEZAS DE MLS).	1999/2001	CA-175-ML 	MS-4175-NS 	
FS-175-ML 			MULTIPLE DE ESCAPE EXHAUST MS-4175-E 	PUNTERIAS VALVE COVER VS-3175-R 	CARTER OIL PAN OS-1175-1R
DISTRIBUCIÓN TIMING COVER TC-6175-LS 	RETÉN CIGÜEÑAL CRANK SEAL BS-7175-NT 	SELLOS DE VALVULA STEM SEALS SS-8152-V 	JUNTAS VARIAS MISCELLANEOUS N/A	N/A	

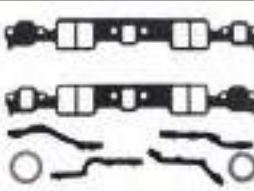

5.3L	MOTOR	MODELOS	DESDE / A	JUNTA DE CABEZA		MÚLTIPLE DE ADMISIÓN O PLENO
ENGINE	MODELS	FROM / TO	HEAD GASKET		INTAKE	
V8 OHV 16V VORTEC VIN T ZV 3	SUBURBAN, SILVERADO 1500, 2500, SIERRA 1500, 2500, YUKON, AVALANCHE, SAVANA, EXPRESS VAN 1500, 2500, SONORA.	2002/2009	CA-175-G 		MS-4175-1NS 	
FS-175-1G 						
DISTRIBUCIÓN		RETÉN CIGÜEÑAL	SELLOS DE VALVULA	JUNTAS VARIAS	N/A	
TIMING COVER		CRANK SEAL	STEM SEALS	MISCELLANEOUS		
TC-6175 	BS-7175-NT 	SS-8152-1V 	N/A			

5.7L	MOTOR	MODELOS	DESDE / A	JUNTA DE CABEZA		MÚLTIPLE DE ADMISIÓN O PLENO
ENGINE	MODELS	FROM / TO	HEAD GASKET		INTAKE	
V8 OHV 16V VORTEC MEXICO TBI	MICROBUS, SUBURBAN, C-2500, C-3500, PICK-UP SOLO MEXICO.	1992/1998	CA-150-G 		MS-4150-6 	
FS-150-M 						
DISTRIBUCIÓN		RETÉN CIGÜEÑAL	SELLOS DE VALVULA	JUNTAS VARIAS	N/A	
TIMING COVER		CRANK SEAL	STEM SEALS	MISCELLANEOUS		
TC-6150-5 	BS-7150-R 	SS-8140-16P 				



5.7L	MOTOR	MODELOS	DESDE / A	JUNTA DE CABEZA	MULTIPLE DE ADMISIÓN O PLENO
ENGINE	MODELS	FROM / TO	HEAD GASKET	INTAKE	
V8 OHV 16V VORTEC VIN R K	SUBURBAN, YUKON, EXPRESS VAN 1500, 2500, 3500, SILVERADO 1500, 2500, SONORA, TAHOE, ESCALADE.	1996/2002	CA-150-G 	MS-4150-8 	
FS-150-10 			MULTIPLE DE ESCAPE EXHAUST MS-4150-3E 	PUNTERIAS VALVE COVER VS-3150-1R 	CARTER OIL PAN OS-1150-1R
DISTRIBUCIÓN TIMING COVER TC-6150-5 	RETÉN CIGÜEÑAL CRANK SEAL BS-7160-1T 	SELLOS DE VALVULA STEM SEALS SS-8160-16V 	JUNTAS VARIAS MISCELLANEOUS N/A	N/A	

5.7L	MOTOR	MODELOS	DESDE / A	JUNTA DE CABEZA	MULTIPLE DE ADMISIÓN O PLENO
ENGINE	MODELS	FROM / TO	HEAD GASKET	INTAKE	
V8 OHV 16V 350"	MALIBU, MONTE CARLO, IMPALA, CHEVELLE, CORVETTE, CAPRICE, CAMARO, PICK UP C10, C20, C30, SUBURBAN.	1973/1991	CA-150-G 	MS-4150-3 	
FS-150-5 			MULTIPLE DE ESCAPE EXHAUST MS-4150-E 	PUNTERIAS VALVE COVER VS-3150 	CARTER OIL PAN OS-1150
DISTRIBUCIÓN TIMING COVER TC-6150-5 	RETÉN CIGÜEÑAL CRANK SEAL BS-7150-R 	SELLOS DE VALVULA STEM SEALS SS-8140-16P 	JUNTAS VARIAS MISCELLANEOUS N/A	N/A	



5.7L	MOTOR	MODELOS	DESDE / A	JUNTA DE CABEZA	MULTIPLE DE ADMISIÓN O PLENO
ENGINE	MODELS	FROM / TO	HEAD GASKET	INTAKE	
V8 OHV 16V 350"	PICK UP K10, K20, K30, C10, C20, C30, SUBURBAN, IMPALA, MICRO-BUS.	1981/1986	CA-150-G	MS-4150-3	
FS-150-6					
			MULTIPLE DE ESCAPE	PUNTERIAS	CARTER
			EXHAUST	VALVE COVER	OIL PAN
			MS-4150-E	VS-3150	OS-1150-1R
DISTRIBUCIÓN	RETÉN CIGÜEÑAL		SELLOS DE VALVULA	JUNTAS VARIAS	N/A
TIMING COVER	CRANK SEAL		STEM SEALS	MISCELLANEOUS	
TC-6150-5	BS-7160		SS-8140-16P	N/A	

5.7L	MOTOR	MODELOS	DESDE / A	JUNTA DE CABEZA	MULTIPLE DE ADMISIÓN O PLENO
ENGINE	MODELS	FROM / TO	HEAD GASKET	INTAKE	
V8 OHV 16V 350"	AUTOS Y CAMIONES USA.	1987/1988	CA-150-G	MS-4150-3	
FS-150-7					
			MULTIPLE DE ESCAPE	PUNTERIAS	CARTER
			EXHAUST	VALVE COVER	OIL PAN
			MS-4150-E	VS-3150-1R	OS-1150-1R
DISTRIBUCIÓN	RETÉN CIGÜEÑAL		SELLOS DE VALVULA	JUNTAS VARIAS	N/A
TIMING COVER	CRANK SEAL		STEM SEALS	MISCELLANEOUS	
TC-6150-5	BS-7160		SS-8140-16P	N/A	



5.7L	MOTOR	MODELOS	DESDE / A	JUNTA DE CABEZA	MULTIPLE DE ADMISIÓN O PLENO
ENGINE	MODELS	FROM / TO	HEAD GASKET	INTAKE	
V8 OHV 16V TBI	CAMIONETAS "TBI" C1500, C2500, C3500, V1500, V2500, V3500, K1500, K2500, K3500, YUKON, TAHOE, BLAZER.	1989/1996	CA-150-G 	MS-4150-6 	
FS-150-8 			MULTIPLE DE ESCAPE EXHAUST MS-4150-E 	PUNTERIAS VALVE COVER VS-3150-1R 	CARTER OIL PAN OS-1150-1R
DISTRIBUCIÓN TIMING COVER TC-6150-5 	RETÉN CIGÜEÑAL CRANK SEAL BS-7160 	SELLOS DE VALVULA STEM SEALS SS-8140-16P 	JUNTAS VARIAS MISCELLANEOUS N/A	N/A	

5.7L	MOTOR	MODELOS	DESDE / A	JUNTA DE CABEZA	MULTIPLE DE ADMISIÓN O PLENO
ENGINE	MODELS	FROM / TO	HEAD GASKET	INTAKE	
V8 OHV 16V VIN P.	FIREBIRD, CAMA-RO Z28, CAPRICE.	1992/1997	CA-151-1G 	MS-4151 	
FS-151-1 			MULTIPLE DE ESCAPE EXHAUST MS-4151-E 	PUNTERIAS VALVE COVER VS-3150-1R 	CARTER OIL PAN OS-1150-1R
DISTRIBUCIÓN TIMING COVER TC-6150-6 	RETÉN CIGÜEÑAL CRANK SEAL BS-7160 	SELLOS DE VALVULA STEM SEALS SS-8160-16V 	JUNTAS VARIAS MISCELLANEOUS N/A	N/A	



6.0L	MOTOR	MODELOS	DESDE / A	JUNTA DE CABEZA	MÚLTIPLE DE ADMISIÓN O PLENO
ENGINE	MODELS	FROM / TO	HEAD GASKET	INTAKE	
V8 OHV 16V VORTEC VIN U	SILVERADO 2500, SIERRA 2500, YUKON, EXPRESS VAN, CARGO VAN, SUBURBAN (CABEZA DE GRAFITO).	1999/2001	CA-176-G 	MS-4175-NS 	
FS-176-G 			MÚLTIPLE DE ESCAPE EXHAUST MS-4175-E 	PUNTERIAS VALVE COVER VS-3175-R 	CARTER OIL PAN OS-1175
DISTRIBUCIÓN TIMING COVER TC-6175 	RETÉN CIGÜEÑAL CRANK SEAL BS-7175-NT 	SELLOS DE VALVULA STEM SEALS SS-8152-V 	JUNTAS VARIAS MISCELLANEOUS N/A	N/A	

6.0L	MOTOR	MODELOS	DESDE / A	JUNTA DE CABEZA	MÚLTIPLE DE ADMISIÓN O PLENO
ENGINE	MODELS	FROM / TO	HEAD GASKET	INTAKE	
V8 OHV 16V VORTEC VIN U	SILVERADO 2500, SIERRA 2500, YUKON, EXPRESS VAN, CARGO VAN, SUBURBAN (CABEZAS DE MLS).	1999/2001	CA-176-ML 	MS-4175-NS 	
FS-176-ML 			MÚLTIPLE DE ESCAPE EXHAUST MS-4175-E 	PUNTERIAS VALVE COVER VS-3175-R 	CARTER OIL PAN OS-1175-1R
DISTRIBUCIÓN TIMING COVER TC-6175-LS 	RETÉN CIGÜEÑAL CRANK SEAL BS-7175-NT 	SELLOS DE VALVULA STEM SEALS SS-8152-V 	JUNTAS VARIAS MISCELLANEOUS N/A	N/A	



6.0L	MOTOR	MODELOS	DESDE / A	JUNTA DE CABEZA	MULTIPLE DE ADMISIÓN O PLENO
ENGINE	MODELS	FROM / TO	HEAD GASKET	INTAKE	
V8 OHV 16V VIN VORTEC N U Y K	SUBURBAN, YUKON, SIERRA 2500, SILVERADO 1500, 2500, 3500, EXPRESS VAN 2500, 3500, CORVETTE, AVALANCHE.	2001/2007	CA-176-G 	MS-4175-1NS 	
FS-176-1G 			MULTIPLE DE ESCAPE EXHAUST MS-4175-E 	PUNTERIAS VALVE COVER VS-3175-R 	CARTER OIL PAN OS-1175
DISTRIBUCIÓN TIMING COVER TC-6175 	RETÉN CIGÜEÑAL CRANK SEAL BS-7175-NT 	SELLOS DE VALVULA STEM SEALS SS-8152-1V 	JUNTAS VARIAS MISCELLANEOUS N/A	N/A	

6.2L	MOTOR	MODELOS	DESDE / A	JUNTA DE CABEZA	MULTIPLE DE ADMISIÓN O PLENO
ENGINE	MODELS	FROM / TO	HEAD GASKET	INTAKE	
V8 OHV 16V VIN C X J	SUBURBAN 1500, 2500, 3500, PICK UP K1500, 2500, 3500, C1500, C2500, C3500, HUMMER, (DIESEL).	1982/1993	CA-179-G 	MS-4180-AD 	
FS-179 			MULTIPLE DE ESCAPE EXHAUST MS-4180-E 	PUNTERIAS VALVE COVER VS-3180 	CARTER OIL PAN OS-1180-1
DISTRIBUCIÓN TIMING COVER TC-6180 	RETÉN CIGÜEÑAL CRANK SEAL BS-7179 	SELLOS DE VALVULA STEM SEALS SS-8180-V 	JUNTAS VARIAS MISCELLANEOUS N/A	N/A	



6.5L	MOTOR	MODELOS	DESDE / A	JUNTA DE CABEZA		MÚLTIPLE DE ADMISIÓN O PLENO
ENGINE	MODELS	FROM / TO	HEAD GASKET		INTAKE	
V8 OHV 16V VIN F P S Y Z	PICK UP C1500, C2500, C3500, K1500, K2500, K3500, EXPRESS 2500, 3500, SAVANA, YUKON, TAHOE, HUMMER H1, (DIESEL).	1994/2005	CA-180-GD 		MS-4180-1 	
FS-180						
			MÚLTIPLE DE ESCAPE EXHAUST MS-4180-E 	PUNTERIAS VALVE COVER VS-3180 	CARTER OIL PAN OS-1180-A 	
DISTRIBUCIÓN TIMING COVER TC-6180 	RETÉN CIGÜEÑAL CRANK SEAL BS-7180-1 	SELLOS DE VALVULA STEM SEALS SS-8180-V 	JUNTAS VARIAS MISCELLANEOUS N/A			

7.4L	MOTOR	MODELOS	DESDE / A	JUNTA DE CABEZA		MÚLTIPLE DE ADMISIÓN O PLENO
ENGINE	MODELS	FROM / TO	HEAD GASKET		INTAKE	
V8 OHV 16V VIN N	C1500, C2500, C3500, K2500, K3500.	1991/1996	CA-168-G 		MS-4167 	
FS-168-2						
			MÚLTIPLE DE ESCAPE EXHAUST MS-4167-E 	PUNTERIAS VALVE COVER VS-3168-R 	CARTER OIL PAN OS-1168-R 	
DISTRIBUCIÓN TIMING COVER TC-6167 	RETÉN CIGÜEÑAL CRANK SEAL BS-7168 	SELLOS DE VALVULA STEM SEALS ** N/A **	JUNTAS VARIAS MISCELLANEOUS N/A			



7.4L	MOTOR	MODELOS	DESDE / A	JUNTA DE CABEZA	MULTIPLE DE ADMISIÓN O PLENO
ENGINE	MODELS	FROM / TO	HEAD GASKET	INTAKE	
V8 OHV 16V 454" VORTEC VIN J	KODIAK C2500, C3500, K2500, K3500.	1996/2000	CA-169-G	MS-4169	
FS-169 			MULTIPLE DE ESCAPE EXHAUST MS-4169-E 	PUNTERIAS VALVE COVER VS-3168-R 	CARTER OIL PAN OS-1168-R
DISTRIBUCIÓN TIMING COVER TC-6169 	RETÉN CIGÜEÑAL CRANK SEAL BS-7168 	SELLOS DE VALVULA STEM SEALS SS-8167-NV 	JUNTAS VARIAS MISCELLANEOUS N/A	N/A	

8.1L	MOTOR	MODELOS	DESDE / A	JUNTA DE CABEZA	MULTIPLE DE ADMISIÓN O PLENO
ENGINE	MODELS	FROM / TO	HEAD GASKET	INTAKE	
V8 OHV 16V	SILVERADO, 2500HD, 3500, SIERRA 2500, 3500, YUKON, SUBURBAN, AVALANCHE, EXPRESS VAN.	2001/2007	CA-181-G Y CA-182-G	MS-1181	
FS-181 			PARA VER IMAGEN DIRIGIRSE A SECCIÓN DE JUNTAS DE CABEZA. TO SEE IMAGE GO TO SECTION HEAD GASKETS 		
DISTRIBUCIÓN TIMING COVER TC-6181 	RETÉN CIGÜEÑAL CRANK SEAL BS-7181-PT 	SELLOS DE VALVULA STEM SEALS SS-8181-V 	JUNTAS VARIAS MISCELLANEOUS N/A	N/A	

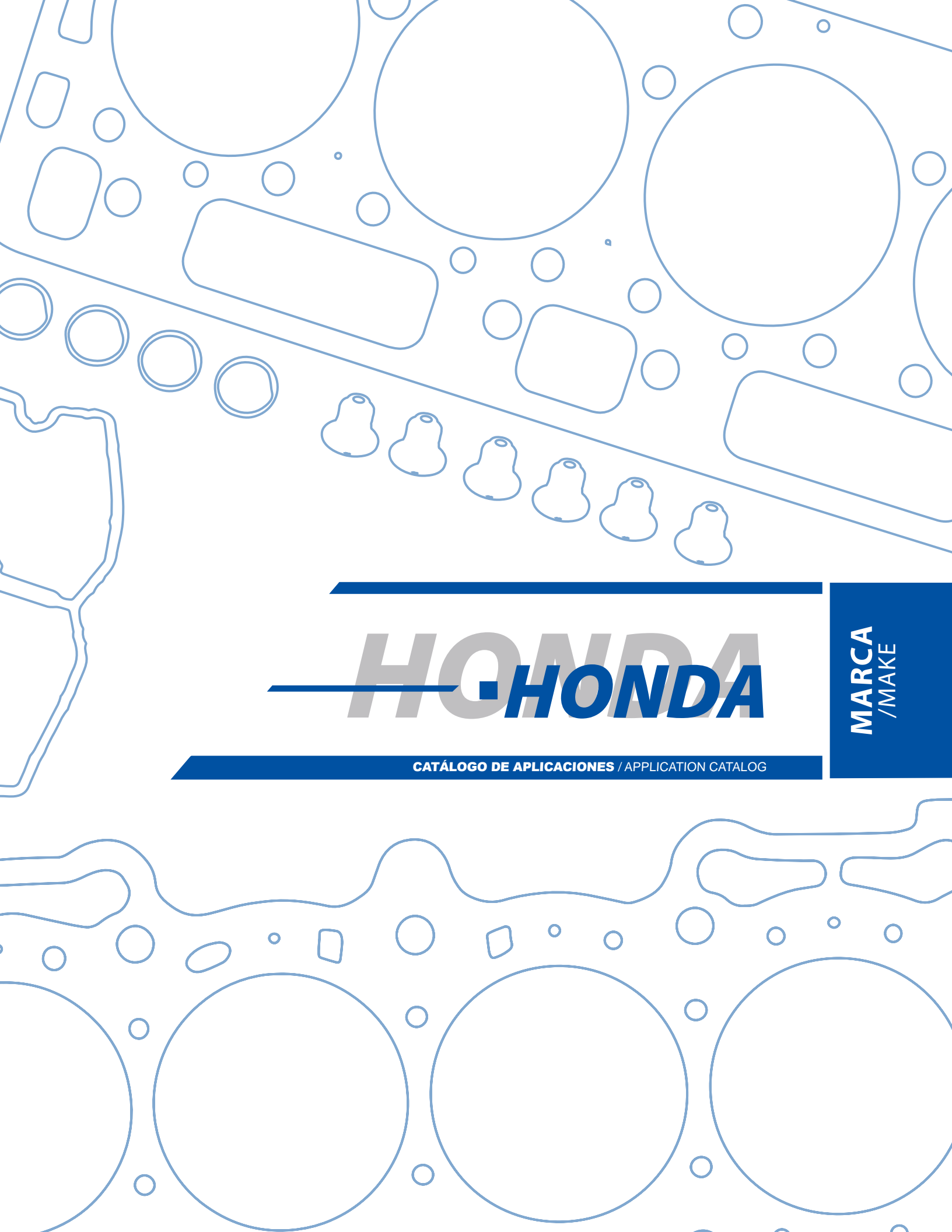

HONDA

**MARCA
/MAKE**

CATÁLOGO DE APLICACIONES / APPLICATION CATALOG

HONDA





LITROS	MODELO	AÑO	PÁGINA
LITERS	MODEL	YEAR	PAGE
1.2L	CIVIC.	1973/1979	*
1.3L	CIVIC.	1984/1987	*
1.5L	CIVIC.	1984/1991	*
1.5L	CIVIC.	1975/1983	*
1.5L	CIVIC (CABEZA DE GRAFITO).	1988/1995	*
1.5L	CIVIC (CABEZA DE MLS).	1992/1995	137
1.6L	CIVIC DEL SOL.	1994/2000	*
1.6L	CIVIC. ACURA EL (CABEZA DE GRAFITO).	1996/2000	*
1.6L	CIVIC , ACURA EL (CABEZA DE MLS).	1996/2000	137
1.7L	CIVIC, ACURA EL.	2001/2005	*
1.8L	ACURA INTEGRA.	1994/2001	*
1.8L	ACURA INTEGRA.	1990/1995	138
1.8L	CIVIC EX, DX, LXS.	2006/2009	*
2.0L	ACCORD, PRELUDE.	1985/1989	*
2.0L	CR-V.	1997/2001	*
2.2L	ACCORD, PRELUDE.	1990/1997	*
2.2L	ACCORD.	1990/1991	138
2.3L	ACCORD, ODYSSEY, ACURA CL.	1998/2002	*
2.3L	PRELUDE.	1992/1996	*
2.4L	CR-V.	2002/2006	*
2.4L	CR-V, ACCORD, ELEMENT, ACURA TSX.	2004/2010	*
2.7L	ACCORD.	1995/1997	*
3.0L	ACCORD , ACURA CL.	1997/2002	*
3.2L	ACURA LEGEND, TL.	1991/1998	*
3.2L	ACURA CL, TL.	1999/2003	*
3.2L	ACURA TL.	2004/2008	*
3.5L	PILOT, RIDGELINE, ODYSSEY, ACURA MDX.	2001/2009	*
3.5L	ACURA RL.	1996/2004	*
3.5L	ODYSSEY, PILOT, ACURA MDX.	1999/2004	*
3.5L	PILOT, ODYSSEY, RIDGELINE, ACURA MDX, SATURN VUE.	2003/2010	*
3.5L	ACCORD, ACCORD CROSSTOUR, PILOT, RIDGELINE, ODYSSEY, ACURA RDX, TSX, TL.	2008/2013	*







1.5L	MOTOR	MODELOS	DESDE / A	JUNTA DE CABEZA	MULTIPLE DE ADMISIÓN O PLENO
ENGINE	MODELS	FROM / TO	HEAD GASKET	INTAKE	
4L SOHC 8V y 16V D15B7, D15B8.	CIVIC (CABEZA DE MLS).	1992/1995	CA-1455-ML 	MS-41452-3 	
FS-1456 			MULTIPLE DE ESCAPE EXHAUST MS-41452-1E 	PUNTERIAS VALVE COVER VS-31452-2R 	CARTER OIL PAN OS-11450-R
DISTRIBUCIÓN TIMING COVER TC-61452 	RETÉN CIGÜEÑAL CRANK SEAL BS-71452 	SELLOS DE VALVULA STEM SEALS SS-81452-V 	JUNTAS VARIAS MISCELLANEOUS		

1.6L	MOTOR	MODELOS	DESDE / A	JUNTA DE CABEZA	MULTIPLE DE ADMISIÓN O PLENO
ENGINE	MODELS	FROM / TO	HEAD GASKET	INTAKE	
4L SOHC 16V MOTOR VTEC D16Y5, D16Y7, D16Y8.	CIVIC , ACURA EL (CABEZA DE MLS).	1996/2000	CA-1455-ML 	MS-41455 	
FS-1455 			MULTIPLE DE ESCAPE EXHAUST MS-41452-1E 	PUNTERIAS VALVE COVER VS-31455 	CARTER OIL PAN OS-11455-1R
DISTRIBUCIÓN TIMING COVER TC-61455-1 	RETÉN CIGÜEÑAL CRANK SEAL BS-71452 	SELLOS DE VALVULA STEM SEALS SS-81452-V 	JUNTAS VARIAS MISCELLANEOUS		

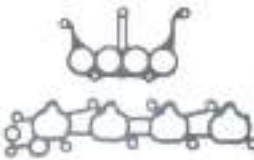

1.8L	MOTOR	MODELOS	DESDE / A	JUNTA DE CABEZA	MÚLTIPLE DE ADMISIÓN O PLENO		
ENGINE	MODELS	FROM / TO	HEAD GASKET	INTAKE			
4L DOHC 16V B18A, B18C1.	ACURA INTEGRA.	1990/1995	CA-1458-ML 	MS-41451 			
FS-1458							
DISTRIBUCIÓN		RETÉN CIGÜEÑAL		SELLOS DE VALVULA		JUNTAS VARIAS	
TIMING COVER		CRANK SEAL		STEM SEALS		MISCELLANEOUS	
TC-61454		BS-71452		SS-81452-V			
							

2.2L	MOTOR	MODELOS	DESDE / A	JUNTA DE CABEZA	MÚLTIPLE DE ADMISIÓN O PLENO		
ENGINE	MODELS	FROM / TO	HEAD GASKET	INTAKE			
4L SOHC 16V F22A4, F22A6, F22A1.	ACCORD.	1990/1991	CA-1457-ML 	MS-41457 			
FS-1457							
DISTRIBUCIÓN		RETÉN CIGÜEÑAL		SELLOS DE VALVULA		JUNTAS VARIAS	
TIMING COVER		CRANK SEAL		STEM SEALS		MISCELLANEOUS	
TC-61457		BS-71452		SS-81452-V			
							

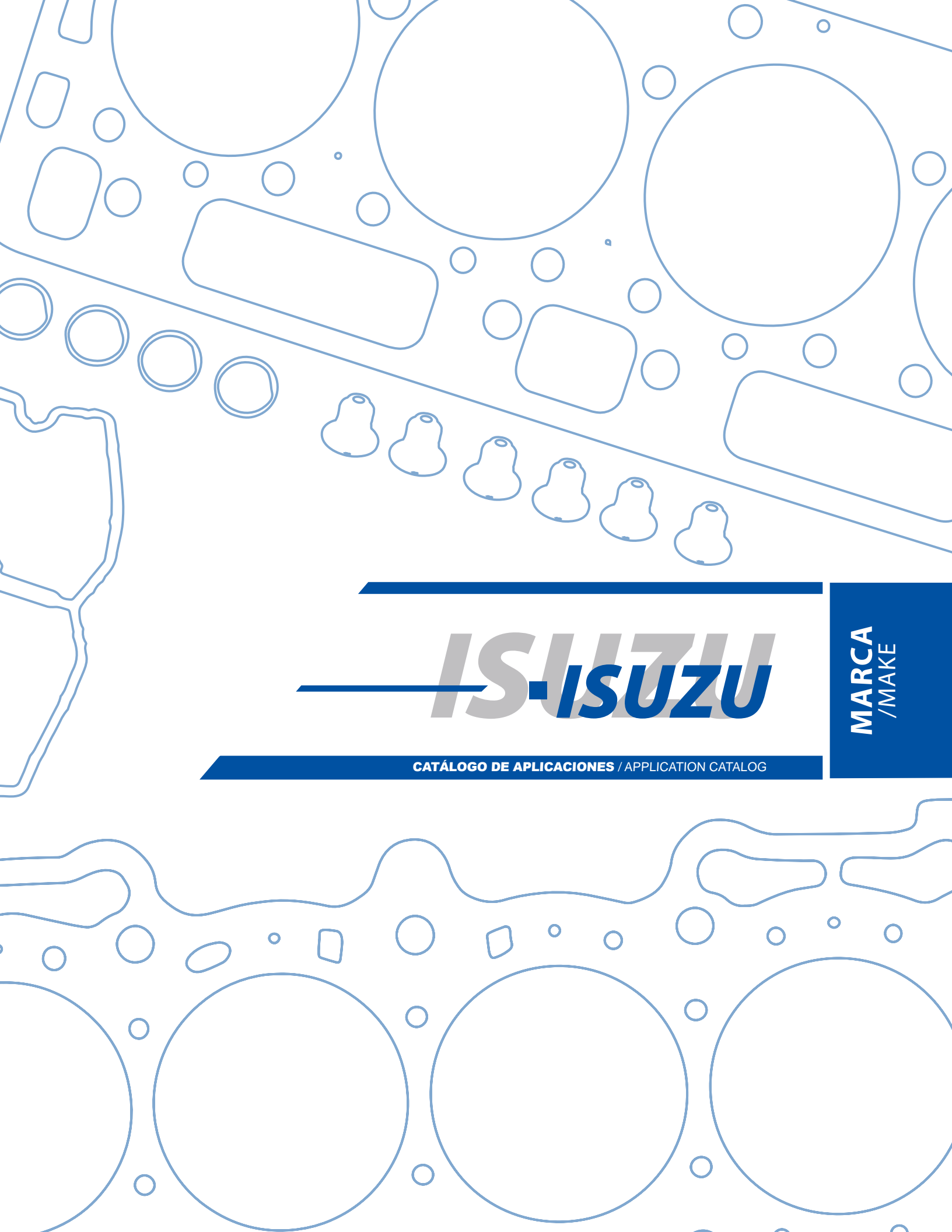

ISUZU

**MARCA
/MAKE**

CATÁLOGO DE APLICACIONES / APPLICATION CATALOG

ISUZU







LITROS	MODELO	AÑO	PÁGINA
LITERS	MODEL	YEAR	PAGE
2.3L	AMIGO, TROOPER, IMPULSE, PICK UP.	1986/1995	143
2.6L	RODEO, TROOPER, AMIGO.	1988/1997	143
3.0L	ISUZU ELF SERIES 200/300.	2008/2013	*
3.2L	RODEO, TROOPER, HONDA PASSPORT.	1992/1995	144
3.2L	RODEO, AMIGO, TROOPER, AXIOM, VehiCROSS, HONDA PASSPORT.	1988/2003	*
3.5L	RODEO, AMIGO, TROOPER, AXIOM, VehiCROSS, HONDA PASSPORT.	1998/2003	*

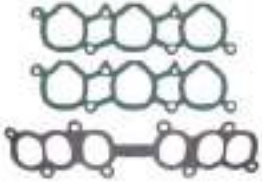

2.3L	MOTOR	MODELOS	DESDE / A	JUNTA DE CABEZA	MULTIPLE DE ADMISIÓN O PLENO
ENGINE	MODELS	FROM / TO	HEAD GASKET	INTAKE	
4L SOHC 8V MOTOR 4ZD1 VIN L	AMIGO, TROOPER, IMPULSE, PICK UP.	1986/1995	CA-1710-G	MS-41710	
FS-1710 					
			MULTIPLE DE ESCAPE	PUNTERIAS	CARTER
			EXHAUST	VALVE COVER	OIL PAN
			MS-41710-E	VS-31710-R	OS-11710-R
DISTRIBUCIÓN	RETÉN CIGÜEÑAL		SELLOS DE VALVULA	JUNTAS VARIAS	
TIMING COVER	CRANK SEAL		STEM SEALS	MISCELLANEOUS	
TC-61710-1	BS-71710		SS-81218		

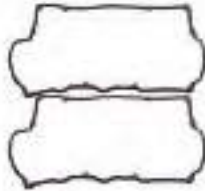
2.6L	MOTOR	MODELOS	DESDE / A	JUNTA DE CABEZA	MULTIPLE DE ADMISIÓN O PLENO
ENGINE	MODELS	FROM / TO	HEAD GASKET	INTAKE	
4L SOHC 8V 4ZE1 VIN E.	RODEO, TROOPER, AMIGO.	1988/1997	CA-1720-G	MS-41710	
FS-1720 					
			MULTIPLE DE ESCAPE	PUNTERIAS	CARTER
			EXHAUST	VALVE COVER	OIL PAN
			MS-41710-E	VS-31710-R	OS-11710-R
DISTRIBUCIÓN	RETÉN CIGÜEÑAL		SELLOS DE VALVULA	JUNTAS VARIAS	
TIMING COVER	CRANK SEAL		STEM SEALS	MISCELLANEOUS	
TC-61710-1	BS-71710		SS-81218		



3.2L	MOTOR	MODELOS	DESDE / A	JUNTA DE CABEZA		MÚLTIPLE DE ADMISIÓN O PLENO	
ENGINE		MODELS	FROM / TO	HEAD GASKET		INTAKE	
V6 SOHC 24V VIN V		RODEO, TROOPER, HONDA PASSPORT.	1992/1995	CA-1750-G 		MS-41750-A 	
FS-1750-G							
				MÚLTIPLE DE ESCAPE	PUNTERIAS	CARTER	
				EXHAUST	VALVE COVER	OIL PAN	
				MS-41750-E 	VS-31750-R 	OS-11750 	
DISTRIBUCIÓN		RETÉN CIGÜEÑAL		SELLOS DE VALVULA		JUNTAS VARIAS	
TIMING COVER		CRANK SEAL		STEM SEALS		MISCELLANEOUS	
TC-61750		BS-71750		SS-8319-V			

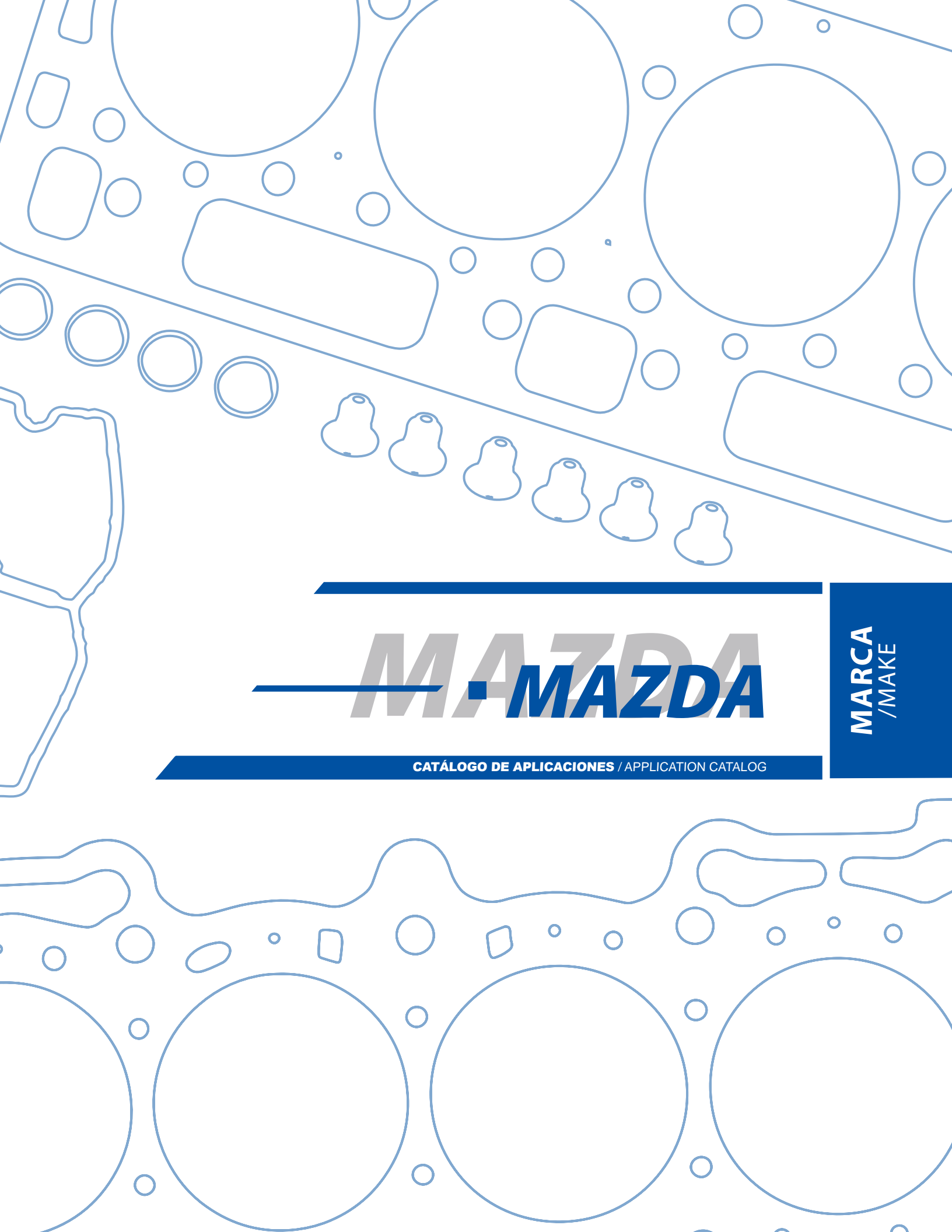

MAZDA

MARCA
/MAKE

CATÁLOGO DE APLICACIONES / APPLICATION CATALOG

MAZDA

LITROS	MODELO	AÑO	PÁGINA
LITERS	MODEL	YEAR	PAGE
1.3L	MODELOS GLC.	1980/1987	149
1.5L	MODELOS GLC.	1980/1987	149
1.6L	MIATA, CAPRI, 323, MX-5.	1988/1994	*
1.6L	323, MERCURY TRACER.	1986/1989	*
1.8L	MIATA.	2001/2005	*
2.0L	PICK UP B2000, 626.	1983/1987	150
2.0L	626, PROTEGE, PROBE, MX-6.	1993/1997	150
2.2L	626, MX-6, FORD PROBE.	1988/1992	151
2.6L	PICK-UP B2600, MPV.	1989/1994	151
3.0L	929, MPV.	1989/1998	152



1.3L	MOTOR	MODELOS	DESDE / A	JUNTA DE CABEZA		MULTIPLE DE ADMISIÓN O PLENO
ENGINE	MODELS	FROM / TO	HEAD GASKET		INTAKE	
4L SOHC 8V MOTOR E3	MODELOS GLC.	1980/1987				
FS-1105						
				MULTIPLE DE ESCAPE	PUNTERIAS	CARTER
				EXHAUST	VALVE COVER	OIL PAN
					VS-31105-R	
DISTRIBUCIÓN		RETÉN CIGÜEÑAL		SELLOS DE VALVULA	JUNTAS VARIAS	
TIMING COVER		CRANK SEAL		STEM SEALS	MISCELLANEOUS	
				SS-81108		

1.5L	MOTOR	MODELOS	DESDE / A	JUNTA DE CABEZA		MULTIPLE DE ADMISIÓN O PLENO
ENGINE	MODELS	FROM / TO	HEAD GASKET		INTAKE	
4L SOHC 8V MOTOR E5	MODELOS GLC.	1980/1987				
FS-1105						
				MULTIPLE DE ESCAPE	PUNTERIAS	CARTER
				EXHAUST	VALVE COVER	OIL PAN
					VS-31105-R	
DISTRIBUCIÓN		RETÉN CIGÜEÑAL		SELLOS DE VALVULA	JUNTAS VARIAS	
TIMING COVER		CRANK SEAL		STEM SEALS	MISCELLANEOUS	
				SS-81108		



2.0L	MOTOR	MODELOS	DESDE / A	JUNTA DE CABEZA	MULTIPLE DE ADMISIÓN O PLENO	
ENGINE	MODELS	FROM / TO	HEAD GASKET	INTAKE		
4L SOHC 8V MOTOR "FE" y "F8"	PICK UP B2000, 626.	1983/1987	CA-1110-G	MS-41110		
FS-1110 			MULTIPLE DE ESCAPE EXHAUST MS-41110-E	PUNTERIAS VALVE COVER VS-31110-R	CARTER OIL PAN OS-11110	
DISTRIBUCIÓN TIMING COVER TC-61110		RETÉN CIGÜEÑAL CRANK SEAL BS-71110		SELLOS DE VALVULA STEM SEALS SS-8304-V		JUNTAS VARIAS MISCELLANEOUS

2.0L	MOTOR	MODELOS	DESDE / A	JUNTA DE CABEZA	MULTIPLE DE ADMISIÓN O PLENO	
ENGINE	MODELS	FROM / TO	HEAD GASKET	INTAKE		
4L DOHC 16V	626 , PROTEGE, PROBE, MX-6.	1993/1997	CA-1112-ML	MS-41112		
FS-1112 			MULTIPLE DE ESCAPE EXHAUST MS-41112-E	PUNTERIAS VALVE COVER VS-31112-R	CARTER OIL PAN OS-11112	
DISTRIBUCIÓN TIMING COVER TC-6319		RETÉN CIGÜEÑAL CRANK SEAL BS-71112		SELLOS DE VALVULA STEM SEALS SS-8109-S		JUNTAS VARIAS MISCELLANEOUS



2.2L	MOTOR	MODELOS	DESDE / A	JUNTA DE CABEZA	MULTIPLE DE ADMISIÓN O PLENO
ENGINE	MODELS	FROM / TO	HEAD GASKET	INTAKE	
4L SOHC 12V MOTOR F2	626, MX-6, FORD PROBE.	1988/1992	CA-1120-G 		
FS-1120 					
			MULTIPLE DE ESCAPE EXHAUST MS-41120-E 	PUNTERIAS VALVE COVER VS-31120-R 	CARTER OIL PAN OS-11110
DISTRIBUCIÓN TIMING COVER		RETÉN CIGÜEÑAL CRANK SEAL BS-71110 	SELLOS DE VALVULA STEM SEALS SS-81120-V 	JUNTAS VARIAS MISCELLANEOUS	

2.6L	MOTOR	MODELOS	DESDE / A	JUNTA DE CABEZA	MULTIPLE DE ADMISIÓN O PLENO
ENGINE	MODELS	FROM / TO	HEAD GASKET	INTAKE	
4L SOHC 12V MOTOR G6	PICK-UP B2600, MPV.	1989/1994	CA-1125-G 	MS-41125-A 	
FS-1125 					
			MULTIPLE DE ESCAPE EXHAUST MS-41125-E 	PUNTERIAS VALVE COVER VS-31125-R 	CARTER OIL PAN OS-11125
DISTRIBUCIÓN TIMING COVER		RETÉN CIGÜEÑAL CRANK SEAL	SELLOS DE VALVULA STEM SEALS SS-81125 	JUNTAS VARIAS MISCELLANEOUS	



3.0L	MOTOR	MODELOS	DESDE / A	JUNTA DE CABEZA		MÚLTIPLE DE ADMISIÓN O PLENO
ENGINE		MODELS	FROM / TO	HEAD GASKET		INTAKE
V6 SOHC 24V		929, MPV.	1989/1998	CA-1130-ML / CA-1131-ML PARA VER IMAGEN DIRIGIRSE A SECCIÓN DE JUNTAS DE CABEZA. TO SEE IMAGE GO TO SECTION HEAD GASKETS		
FS-1130						
				MÚLTIPLE DE ESCAPE	PUNTERIAS	CARTER
				EXHAUST	VALVE COVER	OIL PAN
DISTRIBUCIÓN		RETÉN CIGÜEÑAL		SELLOS DE VALVULA		JUNTAS VARIAS
TIMING COVER		CRANK SEAL		STEM SEALS		MISCELLANEOUS

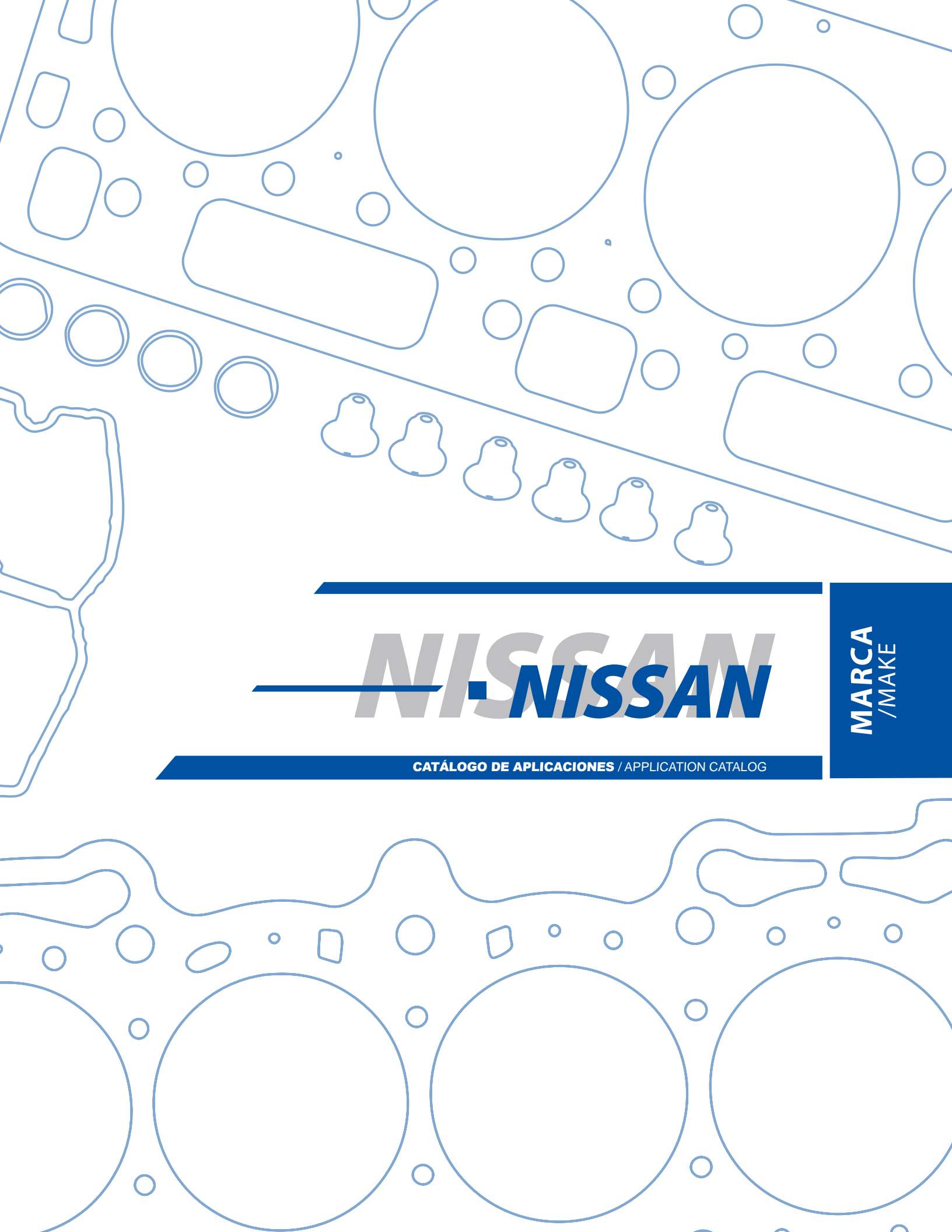

NISSAN

**MARCA
/MAKE**

CATÁLOGO DE APLICACIONES / APPLICATION CATALOG



LITROS	MODELO	AÑO	PÁGINA
LITERS	MODEL	YEAR	PAGE
1.2L	AUTOS & CAMIONETAS.	1959/1969	157
1.2L	AUTOS AMERICANOS.	1980/1982	*
1.3L	AUTOS & CAMIONETAS.	1959/1969	*
1.4L	AUTOS AMERICANOS.	1979/1982	157
1.5L	DATSUN PICK UP, VAGONETA, SEDAN.	1970/1983	158
1.5L	AUTOS AMERICANOS.	1979/1982	158
1.5L	TSURU I.	1983/1987	159
1.6L	DATSUN PICK UP, VAGONETA, SEDAN.	1970/1984	159
1.6L	TSURU II.	1984/1992	160
1.6L	TSURU III, TSUBAME, 200SX, SENTRA, LUCINO.	1991/1996	160
1.6L	TSURU III GSI, GSII, SENTRA MEXICO, TSUBAME.	1997/2014	161
1.6L	SENTRA AMERICANO, PULSAR NX.	1989/1990	161
1.6L	MARCH, VERSA.	2012/2014	162
1.8L	200SX, STANZA.	1982/1988	*
1.8L	SAKURA, ESTAQUITAS, PICK- UP, ICHIVAN (USA).	1980/1994	162
1.8L	PICK-UP, ESTAQUITAS, SAKURA (MEXICO).	1981/1993	163
1.8L	SENTRA, (CABEZA DE GRAFITO).	2000/2003	163
1.8L	SENTRA (CABEZA DE MLS).	2000/2003	*
1.8L	ALMERA, SENTRA.	2000/2006	164
1.8L	TIIDA, SENTRA, VERSA.	2007/2011	164
2.0L	200SX, STANZA.	1982/1988	*
2.0L	200SX, PICK UP 720, 710, 620, 510.	1977/1980	165
2.0L	200SX, PICK UP 510.	1980/1981	165
2.0L	PICK UP 720.	1983/1986	166
2.0L	200SX, LUCINO, SENTRA, TSURU 2000 GSR.	1992/2000	166
2.0L	SENTRA.	2007/2009	167
2.2L	PICK UP 720, 200SX.	1981/1983	167
2.4L	CAMIONETAS VAN, PICK-UP 720, D21.	1983/1989	168
2.4L	ICHI VAN, PICK-UP D21, ESTAQUITAS.	1990/1998	168
2.4L	FRONTIER, PICK UP, URVAN.	2000/2006	169
2.4L	SOLO AUTOS ALTIMA.	1993/1999	169
2.5L	X-TRAIL, ALTIMA, SENTRA (CABEZA DE GRAFITO).	2002/2006	170
2.5L	X-TRAIL, ALTIMA, SENTRA (CABEZA DE MLS).	2002/2006	170
2.5L	CABSTAR TDI.	2008/2010	171
2.5L	ALTIMA, SENTRA, URVAN, FRONTIER, ROGUE.	2007/2009	*
2.5L	URVAN, FRONTIER, EQUATOR.	2005/2012	*
3.0L	QUEST, MERCURY VILLAGER.	1993/1998	171
3.0L	MAXIMA, INFINITI I30.	2000/2001	*
3.0L	URVAN TURBODIESEL.	2001/2009	*
3.0L	MAXIMA, INFINITI I30.	1995/1999	*
3.3L	PATHFINDER, FRONTIER, X-TERRA.	1996/2004	172
3.5L	MAXIMA, ALTIMA, MURANO, QUEST, 350Z, INFINITI G35, I35.	2002/2008	*
3.5L	PATHFINDER, INFINITI, QX4, FX35.	2001/2004	*
5.6L	ARMADA, TITAN, PATHFINDER (CABEZA DE GRAFITO).	2004/2010	*
5.6L	TITAN, ARMADA, PATHFINDER (CABEZA DE GRAFITO).	2004/2010	172



1.2L	MOTOR	MODELOS	DESDE / A	JUNTA DE CABEZA	MULTIPLE DE ADMISIÓN O PLENO
ENGINE	MODELS	FROM / TO	HEAD GASKET	INTAKE	
4L OHV 8V MOTOR J	AUTOS & CAMIONETAS.	1959/1969	CA-1200-G 	MS-41200 	
FS-1200 			MULTIPLE DE ESCAPE EXHAUST N/A	PUNTERIAS VALVE COVER VS-31200 	CARTER OIL PAN OS-11200
DISTRIBUCIÓN TIMING COVER TC-61200 	RETÉN CIGÜEÑAL CRANK SEAL BS-71200 	SELLOS DE VALVULA STEM SEALS N/A	JUNTAS VARIAS MISCELLANEOUS		

1.4L	MOTOR	MODELOS	DESDE / A	JUNTA DE CABEZA	MULTIPLE DE ADMISIÓN O PLENO
ENGINE	MODELS	FROM / TO	HEAD GASKET	INTAKE	
4L OHV 8V MOTOR A14	AUTOS AMERICANOS.	1979/1982	CA-1213-G 	MS-41213 	
FS-1213 			MULTIPLE DE ESCAPE EXHAUST N/A	PUNTERIAS VALVE COVER VS-31213 	CARTER OIL PAN OS-11213
DISTRIBUCIÓN TIMING COVER TC-61213 	RETÉN CIGÜEÑAL CRANK SEAL BS-71213 	SELLOS DE VALVULA STEM SEALS SS-81215 	JUNTAS VARIAS MISCELLANEOUS		



1.5L	MOTOR	MODELOS	DESDE / A	JUNTA DE CABEZA		MÚLTIPLE DE ADMISIÓN O PLENO
ENGINE	MODELS	FROM / TO	HEAD GASKET		INTAKE	
4L OHV 8V MOTOR J15	DATSUN PICK UP, VAGONETA, SEDAN.	1970/1983	CA-1210-GX		MS-41200	
FS-1210 						
DISTRIBUCIÓN		RETÉN CIGÜEÑAL	SELLOS DE VALVULA		JUNTAS VARIAS	
TIMING COVER		CRANK SEAL	STEM SEALS		MISCELLANEOUS	
TC-61200-1		BS-71200		SS-81210		

1.5L	MOTOR	MODELOS	DESDE / A	JUNTA DE CABEZA		MÚLTIPLE DE ADMISIÓN O PLENO
ENGINE	MODELS	FROM / TO	HEAD GASKET		INTAKE	
4L OHV 8V MOTOR A15	AUTOS AMERICANOS.	1979/1982	CA-1213-G		MS-41213	
FS-1213 						
DISTRIBUCIÓN		RETÉN CIGÜEÑAL	SELLOS DE VALVULA		JUNTAS VARIAS	
TIMING COVER		CRANK SEAL	STEM SEALS		MISCELLANEOUS	
TC-61213		BS-71213		SS-81215		



1.5L	MOTOR	MODELOS	DESDE / A	JUNTA DE CABEZA	MULTIPLE DE ADMISIÓN O PLENO
ENGINE	MODELS	FROM / TO	HEAD GASKET	INTAKE	
4L SOHC 8V E15	TSURU I.	1983/1987	CA-1216-G 	MS-41216-A 	
FS-1216 			MULTIPLE DE ESCAPE EXHAUST MS-41216-E 	PUNTERIAS VALVE COVER VS-31216-R 	CARTER OIL PAN OS-11216
DISTRIBUCIÓN TIMING COVER TC-61216 	RETÉN CIGÜEÑAL CRANK SEAL BS-71216 	SELLOS DE VALVULA STEM SEALS SS-81216 	JUNTAS VARIAS MISCELLANEOUS 		

1.6L	MOTOR	MODELOS	DESDE / A	JUNTA DE CABEZA	MULTIPLE DE ADMISIÓN O PLENO
ENGINE	MODELS	FROM / TO	HEAD GASKET	INTAKE	
4L OHV 8V MOTOR J16	DATSUN PICK UP, VAGONETA, SEDAN.	1970/1984	CA-1210-GX 	MS-41200 	
FS-1210-1 			MULTIPLE DE ESCAPE EXHAUST	PUNTERIAS VALVE COVER VS-31210 	CARTER OIL PAN OS-11200
DISTRIBUCIÓN TIMING COVER TC-61200-1 	RETÉN CIGÜEÑAL CRANK SEAL BS-71200 	SELLOS DE VALVULA STEM SEALS SS-81210 	JUNTAS VARIAS MISCELLANEOUS		



1.6L	MOTOR	MODELOS	DESDE / A	JUNTA DE CABEZA	MULTIPLE DE ADMISIÓN O PLENO
ENGINE	MODELS	FROM / TO	HEAD GASKET	INTAKE	
4L SOHC 8V E16	TSURU II.	1984/1992	CA-1216-G 	MS-41216-A 	
FS-1216 			MULTIPLE DE ESCAPE EXHAUST MS-41216-1E 	PUNTERIAS VALVE COVER VS-31216-1R 	CARTER OIL PAN OS-11216
DISTRIBUCIÓN TIMING COVER TC-61216 	RETÉN CIGÜEÑAL CRANK SEAL BS-71216 	SELLOS DE VALVULA STEM SEALS SS-81216 	JUNTAS VARIAS MISCELLANEOUS 1216 		

1.6L	MOTOR	MODELOS	DESDE / A	JUNTA DE CABEZA	MULTIPLE DE ADMISIÓN O PLENO
ENGINE	MODELS	FROM / TO	HEAD GASKET	INTAKE	
4L DOHC 16V GA16DE MOTOR JAPONES	TSURU III, TSU-BAME, 200SX, SENTRA, LUCINO.	1991/1996	CA-1226-G 	MS-41226 	
FS-1226 			MULTIPLE DE ESCAPE EXHAUST MS-41226-E 	PUNTERIAS VALVE COVER VS-31226-R 	CARTER OIL PAN OS-11226
DISTRIBUCIÓN TIMING COVER TC-61226 	RETÉN CIGÜEÑAL CRANK SEAL BS-71226 	SELLOS DE VALVULA STEM SEALS SS-81226-V 	JUNTAS VARIAS MISCELLANEOUS 1226 		



1.6L	MOTOR	MODELOS	DESDE / A	JUNTA DE CABEZA	MULTIPLE DE ADMISIÓN O PLENO
ENGINE	MODELS	FROM / TO	HEAD GASKET	INTAKE	
4L DOHC 16V GA16DE GA16DNE	TSURU III GSI, GSII, SENTRA MEXICO, TSUBAME.	1997/2014	CA-1226-1G 	MS-41226-1 	
FS-1226-1 			MULTIPLE DE ESCAPE EXHAUST	PUNTERIAS VALVE COVER	CARTER OIL PAN
DISTRIBUCIÓN TIMING COVER			SELLOS DE VALVULA STEM SEALS	JUNTAS VARIAS MISCELLANEOUS	
TC-61226 	RETÉN CIGÜEÑAL CRANK SEAL	BS-71226 	SS-81226-V 		OS-11216

1.6L	MOTOR	MODELOS	DESDE / A	JUNTA DE CABEZA	MULTIPLE DE ADMISIÓN O PLENO
ENGINE	MODELS	FROM / TO	HEAD GASKET	INTAKE	
4L SOHC 12 V MOTOR GA16I	SENTRA AMERICANO, PULSAR NX.	1989/1990	CA-1227-G 	MS-41227 	
FS-1227 			MULTIPLE DE ESCAPE EXHAUST	PUNTERIAS VALVE COVER	CARTER OIL PAN
DISTRIBUCIÓN TIMING COVER			SELLOS DE VALVULA STEM SEALS	JUNTAS VARIAS MISCELLANEOUS	
TC-61226 	RETÉN CIGÜEÑAL CRANK SEAL	BS-71226 	SS-81227 		OS-11226



1.6L	MOTOR	MODELOS	DESDE / A	JUNTA DE CABEZA	MÚLTIPLE DE ADMISIÓN O PLENO
ENGINE	MODELS	FROM / TO	HEAD GASKET	INTAKE	
4L DOHC 16 V 98" HR16DE	MARCH, VERSA.	2012/2014	<p>CA-1242-2ML</p>		
<p>FS-1242-ML</p>			<p>MÚLTIPLE DE ESCAPE</p> <p>EXHAUST</p>	<p>PUNTERIAS</p> <p>VALVE COVER</p>	<p>CARTER</p> <p>OIL PAN</p>
				<p>VS-31242-R</p>	
<p>DISTRIBUCIÓN</p> <p>TIMING COVER</p>		<p>RETÉN CIGÜEÑAL</p> <p>CRANK SEAL</p>	<p>SELLOS DE VALVULA</p> <p>STEM SEALS</p>	<p>JUNTAS VARIAS</p> <p>MISCELLANEOUS</p>	
		<p>BS-71242-V</p>			

1.8L	MOTOR	MODELOS	DESDE / A	JUNTA DE CABEZA	MÚLTIPLE DE ADMISIÓN O PLENO
ENGINE	MODELS	FROM / TO	HEAD GASKET	INTAKE	
4L OHV 8V MOTOR J18	SAKURA, ESTAQUITAS, PICK-UP, ICHIVAN (USA).	1980/1994	<p>CA-1215-G</p>	<p>MS-41215</p>	
<p>FS-1215</p>			<p>MÚLTIPLE DE ESCAPE</p> <p>EXHAUST</p>	<p>PUNTERIAS</p> <p>VALVE COVER</p>	<p>CARTER</p> <p>OIL PAN</p>
			<p>** N/A **</p> <p>N/A</p>	<p>VS-31210</p>	<p>OS-11200</p>
<p>DISTRIBUCIÓN</p> <p>TIMING COVER</p>		<p>RETÉN CIGÜEÑAL</p> <p>CRANK SEAL</p>	<p>SELLOS DE VALVULA</p> <p>STEM SEALS</p>	<p>JUNTAS VARIAS</p> <p>MISCELLANEOUS</p>	
		<p>BS-71200</p>	<p>SS-81215</p>		
<p>TC-61200-1</p>					



1.8L	MOTOR	MODELOS	DESDE / A	JUNTA DE CABEZA	MULTIPLE DE ADMISIÓN O PLENO
ENGINE	MODELS	FROM / TO	HEAD GASKET	INTAKE	
4L OHV 8V MOTOR J18 MEXICO	PICK-UP, ESTAQUITAS, SAKURA (MEXICO).	1981/1993	CA-1215-G 	MS-41215 	
FS-1215-1 			MULTIPLE DE ESCAPE EXHAUST ** N/A ** N/A	PUNTERIAS VALVE COVER VS-31210 	CARTER OIL PAN OS-11200
DISTRIBUCIÓN TIMING COVER TC-61200-1 	RETÉN CIGÜEÑAL CRANK SEAL BS-71200 	SELLOS DE VALVULA STEM SEALS SS-81215 	JUNTAS VARIAS MISCELLANEOUS		

1.8L	MOTOR	MODELOS	DESDE / A	JUNTA DE CABEZA	MULTIPLE DE ADMISIÓN O PLENO
ENGINE	MODELS	FROM / TO	HEAD GASKET	INTAKE	
4L DOHC 16V QG18DE	SENTRA, (CABEZA DE GRAFITO).	2000/2003	CA-1234-G 	MS-41234 	
FS-1234 			MULTIPLE DE ESCAPE EXHAUST MS-41234-E 	PUNTERIAS VALVE COVER VS-31234-R 	CARTER OIL PAN OS-11226
DISTRIBUCIÓN TIMING COVER ** N/A **	RETÉN CIGÜEÑAL CRANK SEAL BS-71226 	SELLOS DE VALVULA STEM SEALS SS-81226-V 	JUNTAS VARIAS MISCELLANEOUS		



1.8L	MOTOR	MODELOS	DESDE / A	JUNTA DE CABEZA		MÚLTIPLE DE ADMISIÓN O PLENO
ENGINE	MODELS	FROM / TO	HEAD GASKET		INTAKE	
4L DOHC 16V QG18DE	ALMERA, SENTRA.	2000/2006	CA-1234-G		MS-41234	
FS-1234-1						
DISTRIBUCIÓN		RETÉN CIGÜEÑAL	SELLOS DE VALVULA		JUNTAS VARIAS	
TIMING COVER		CRANK SEAL	STEM SEALS		MISCELLANEOUS	
N/A	N/A	BS-71226	SS-81226-V			

1.8L	MOTOR	MODELOS	DESDE / A	JUNTA DE CABEZA		MÚLTIPLE DE ADMISIÓN O PLENO
ENGINE	MODELS	FROM / TO	HEAD GASKET		INTAKE	
4L DOHC 16V MR18DE	TIIDA, SENTRA, VERSA.	2007/2011	CA-1238-ML		MS-41238	
FS-1238						
DISTRIBUCIÓN		RETÉN CIGÜEÑAL	SELLOS DE VALVULA		JUNTAS VARIAS	
TIMING COVER		CRANK SEAL	STEM SEALS		MISCELLANEOUS	
N/A	N/A		N/A			



2.0L	MOTOR	MODELOS	DESDE / A	JUNTA DE CABEZA	MULTIPLE DE ADMISIÓN O PLENO
ENGINE	MODELS	FROM / TO	HEAD GASKET	INTAKE	
4L SOHC 8 VALV MOTOR L20B	200SX, PICK UP 720, 710, 620, 510.	1977/1980	CA-1218-G 	MS-41218-1 	
FS-1218 			MULTIPLE DE ESCAPE EXHAUST ** N/A ** N/A	PUNTERIAS VALVE COVER VS-31218 	CARTER OIL PAN OS-11218
DISTRIBUCIÓN TIMING COVER TC-61218 	RETÉN CIGÜEÑAL CRANK SEAL BS-71218 	SELLOS DE VALVULA STEM SEALS SS-81218 	JUNTAS VARIAS MISCELLANEOUS		

2.0L	MOTOR	MODELOS	DESDE / A	JUNTA DE CABEZA	MULTIPLE DE ADMISIÓN O PLENO
ENGINE	MODELS	FROM / TO	HEAD GASKET	INTAKE	
4L SOHC 8V Z20E	200SX, PICK UP 510.	1980/1981	CA-1222-G 	MS-41222 	
FS-1222 			MULTIPLE DE ESCAPE EXHAUST MS-41222-E 	PUNTERIAS VALVE COVER VS-31222 	CARTER OIL PAN OS-11218
DISTRIBUCIÓN TIMING COVER TC-61218 	RETÉN CIGÜEÑAL CRANK SEAL BS-71218 	SELLOS DE VALVULA STEM SEALS SS-81218 	JUNTAS VARIAS MISCELLANEOUS 		



2.0L	MOTOR	MODELOS	DESDE / A	JUNTA DE CABEZA	MÚLTIPLE DE ADMISIÓN O PLENO
ENGINE	MODELS	FROM / TO	HEAD GASKET	INTAKE	
4L SOHC 8V Z20E	PICK UP 720.	1983/1986	CA-1222-G 	MS-41222 	
FS-1222-1 			MÚLTIPLE DE ESCAPE EXHAUST MS-41222-E 	PUNTERIAS VALVE COVER VS-31222-1R 	CARTER OIL PAN OS-11218
DISTRIBUCIÓN TIMING COVER TC-61218 	RETÉN CIGÜEÑAL CRANK SEAL BS-71218 	SELLOS DE VALVULA STEM SEALS SS-81218 	JUNTAS VARIAS MISCELLANEOUS		

2.0L	MOTOR	MODELOS	DESDE / A	JUNTA DE CABEZA	MÚLTIPLE DE ADMISIÓN O PLENO
ENGINE	MODELS	FROM / TO	HEAD GASKET	INTAKE	
4L DOHC 16V 122" SR20DE	200SX, LUCINO, SENTRA, TSURU 2000 GSR.	1992/2000	CA-1228-G 	MS-41228-A 	
FS-1228 			MÚLTIPLE DE ESCAPE EXHAUST MS-41228-E 	PUNTERIAS VALVE COVER VS-31228-R 	CARTER OIL PAN OS-11228
DISTRIBUCIÓN TIMING COVER N/A	RETÉN CIGÜEÑAL CRANK SEAL N/A	SELLOS DE VALVULA STEM SEALS SS-81227 	JUNTAS VARIAS MISCELLANEOUS		



2.0L	MOTOR	MODELOS	DESDE / A	JUNTA DE CABEZA	MULTIPLE DE ADMISIÓN O PLENO
ENGINE	MODELS	FROM / TO	HEAD GASKET	INTAKE	
4L DOHC 16V MR20DE	SENTRA.	2007/2009	CA-1238-ML 	MS-41238 	
FS-1238 			MULTIPLE DE ESCAPE EXHAUST MS-41238-E 	PUNTERIAS VALVE COVER VS-31238-R 	CARTER OIL PAN
DISTRIBUCIÓN TIMING COVER		RETÉN CIGÜEÑAL CRANK SEAL BS-71242-V 	SELLOS DE VALVULA STEM SEALS	JUNTAS VARIAS MISCELLANEOUS	

2.2L	MOTOR	MODELOS	DESDE / A	JUNTA DE CABEZA	MULTIPLE DE ADMISIÓN O PLENO
ENGINE	MODELS	FROM / TO	HEAD GASKET	INTAKE	
4L SOHC 8V Z22S	PICK UP 720, 200SX.	1981/1983	CA-1224-G 	MS-41222 	
FS-1223 			MULTIPLE DE ESCAPE EXHAUST MS-41222-E 	PUNTERIAS VALVE COVER VS-31322-R 	CARTER OIL PAN OS-11218
DISTRIBUCIÓN TIMING COVER TC-61218 		RETÉN CIGÜEÑAL CRANK SEAL BS-71218 	SELLOS DE VALVULA STEM SEALS SS-81218 	JUNTAS VARIAS MISCELLANEOUS	



2.4L	MOTOR	MODELOS	DESDE / A	JUNTA DE CABEZA	MULTIPLE DE ADMISIÓN O PLENO	
ENGINE	MODELS	FROM / TO	HEAD GASKET	INTAKE		
4L SOHC 8V Z24I Z24S	CAMIONETAS VAN, PICK-UP 720, D21.	1983/1989	CA-1224-G	MS-41224		
FS-1224			MULTIPLE DE ESCAPE	PUNTERIAS	CARTER	
			EXHAUST	VALVE COVER	OIL PAN	
			MS-41222-E	VS-31222-1R	OS-11218	
DISTRIBUCIÓN	RETÉN CIGÜEÑAL		SELLOS DE VALVULA		JUNTAS VARIAS	
TIMING COVER	CRAK SEAL		STEM SEALS		MISCELLANEOUS	
TC-61224	BS-71218		SS-81218			

2.4L	MOTOR	MODELOS	DESDE / A	JUNTA DE CABEZA	MULTIPLE DE ADMISIÓN O PLENO	
ENGINE	MODELS	FROM / TO	HEAD GASKET	INTAKE		
4L SOHC 12V KA24E KA24S	ICHI VAN, PICK-UP D21, ESTAQUITAS.	1990/1998	CA-1225-G	MS-41225		
FS-1225			MULTIPLE DE ESCAPE	PUNTERIAS	CARTER	
			EXHAUST	VALVE COVER	OIL PAN	
			MS-41225-E	VS-31225-R	OS-11225	
DISTRIBUCIÓN	RETÉN CIGÜEÑAL		SELLOS DE VALVULA		JUNTAS VARIAS	
TIMING COVER	CRAK SEAL		STEM SEALS		MISCELLANEOUS	
TC-61225	BS-71216		SS-81225-1			



2.4L	MOTOR	MODELOS	DESDE / A	JUNTA DE CABEZA	MULTIPLE DE ADMISIÓN O PLENO
ENGINE	MODELS	FROM / TO	HEAD GASKET	INTAKE	
4L DOHC 16V MOTOR KA24DE	FRONTIER, PICK UP, URVAN.	2000/2006	CA-1232-G 	MS-41232 	
FS-1232 			MULTIPLE DE ESCAPE EXHAUST MS-41232-E 	PUNTERIAS VALVE COVER VS-31232-R 	CARTER OIL PAN OS-11232
DISTRIBUCIÓN TIMING COVER N/A	N/A	RETÉN CIGÜEÑAL CRANK SEAL BS-71226 	SELLOS DE VALVULA STEM SEALS SS-81225-1 	JUNTAS VARIAS MISCELLANEOUS	



2.4L	MOTOR	MODELOS	DESDE / A	JUNTA DE CABEZA	MULTIPLE DE ADMISIÓN O PLENO
ENGINE	MODELS	FROM / TO	HEAD GASKET	INTAKE	
4L DOHC 16V MOTOR KA24DE	SOLO AUTOS ALTIMA.	1993/1999	CA-1233-G 	MS-41233-A 	
FS-1233 			MULTIPLE DE ESCAPE EXHAUST MS-41232-E 	PUNTERIAS VALVE COVER VS-31233-R 	CARTER OIL PAN OS-11233
DISTRIBUCIÓN TIMING COVER N/A	N/A	RETÉN CIGÜEÑAL CRANK SEAL BS-71216 	SELLOS DE VALVULA STEM SEALS SS-81225-1 	JUNTAS VARIAS MISCELLANEOUS	







2.5L	MOTOR	MODELOS	DESDE / A	JUNTA DE CABEZA	MULTIPLE DE ADMISIÓN O PLENO
ENGINE	MODELS	FROM / TO	HEAD GASKET	INTAKE	
4L DOHC 16 V QR25DE	X-TRAIL, ALTIMA, SENTRA (CABEZA DE GRAFITO).	2002/2006	CA-1235-G 	MS-41235-A 	
FS-1235-G 			MULTIPLE DE ESCAPE EXHAUST MS-41235-E 	PUNTERIAS VALVE COVER VS-31235-R 	CARTER OIL PAN N/A
DISTRIBUCIÓN TIMING COVER N/A	N/A	RETÉN CIGÜEÑAL CRANK SEAL BS-71226 	SELLOS DE VALVULA STEM SEALS SS-81236-V 	JUNTAS VARIAS MISCELLANEOUS 1235	

2.5L	MOTOR	MODELOS	DESDE / A	JUNTA DE CABEZA	MULTIPLE DE ADMISIÓN O PLENO
ENGINE	MODELS	FROM / TO	HEAD GASKET	INTAKE	
4L DOHC 16V QR25DE	X-TRAIL, ALTIMA, SENTRA (CABEZA DE MLS).	2002/2006	CA-1235-ML 	MS-41235-A 	
FS-1235-ML 			MULTIPLE DE ESCAPE EXHAUST MS-41235-E 	PUNTERIAS VALVE COVER VS-31235-R 	CARTER OIL PAN N/A
DISTRIBUCIÓN TIMING COVER N/A	N/A	RETÉN CIGÜEÑAL CRANK SEAL BS-71226 	SELLOS DE VALVULA STEM SEALS SS-81236-V 	JUNTAS VARIAS MISCELLANEOUS 1235	

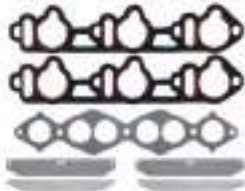

2.5L	MOTOR	MODELOS	DESDE / A	JUNTA DE CABEZA	MULTIPLE DE ADMISIÓN O PLENO
ENGINE	MODELS	FROM / TO	HEAD GASKET	INTAKE	
4L DOHC 16V YD25DDTI TURBODIESEL	CABSTAR TDI.	2008/2010	CA-1241-GX 	MS-41241-HD 	
FS-1241-ML					
					
DISTRIBUCIÓN		RETÉN CIGÜEÑAL		SELLOS DE VALVULA	JUNTAS VARIAS
TIMING COVER		CRANK SEAL		STEM SEALS	MISCELLANEOUS

3.0L	MOTOR	MODELOS	DESDE / A	JUNTA DE CABEZA	MULTIPLE DE ADMISIÓN O PLENO
ENGINE	MODELS	FROM / TO	HEAD GASKET	INTAKE	
V6 SOHC 12V VG30 VG30E	QUEST, MERCURY VILLAGER.	1993/1998	CA-1229-G 	MS-41229 	
FS-1229					
					
DISTRIBUCIÓN		RETÉN CIGÜEÑAL		SELLOS DE VALVULA	JUNTAS VARIAS
TIMING COVER	N/A	CRANK SEAL		STEM SEALS	MISCELLANEOUS
N/A		BS-71226		SS-81229	
					



3.3L	MOTOR	MODELOS	DESDE / A	JUNTA DE CABEZA		MÚLTIPLE DE ADMISIÓN O PLENO
ENGINE	MODELS	FROM / TO	HEAD GASKET		INTAKE	
V6 SOHC 12V VG33DE	PATHFINDER, FRONTIER, X-TERRA.	1996/2004	CA-1229-1G		MS-41229	
FS-1229-1						
				MÚLTIPLE DE ESCAPE	PUNTERIAS	CARTER
				EXHAUST	VALVE COVER	OIL PAN
				MS-41229-E	VS-31229-R	OS-11229-R
DISTRIBUCIÓN	N/A	RETÉN CIGÜEÑAL		SELLOS DE VALVULA		JUNTAS VARIAS
TIMING COVER		CRANK SEAL		STEM SEALS		MISCELLANEOUS
N/A		BS-71226		SS-81229		

5.6L	MOTOR	MODELOS	DESDE / A	JUNTA DE CABEZA		MÚLTIPLE DE ADMISIÓN O PLENO
ENGINE	MODELS	FROM / TO	HEAD GASKET		INTAKE	
V8 DOHC 32V VK56DE	TITAN, ARMADA, PATHFINDER (CABEZA DE GRATITO).	2004/2010	CA-1256-G / CA-1256-1G			
<p>PARA VER IMAGEN DIRIGIRSE A SECCIÓN DE JUNTAS DE CABEZA. TO SEE IMAGE GO TO SECTION HEAD GASKETS</p>						
FS-1256-ML						
				MÚLTIPLE DE ESCAPE	PUNTERIAS	CARTER
				EXHAUST	VALVE COVER	OIL PAN
DISTRIBUCIÓN		RETÉN CIGÜEÑAL		SELLOS DE VALVULA		JUNTAS VARIAS
TIMING COVER		CRANK SEAL		STEM SEALS		MISCELLANEOUS

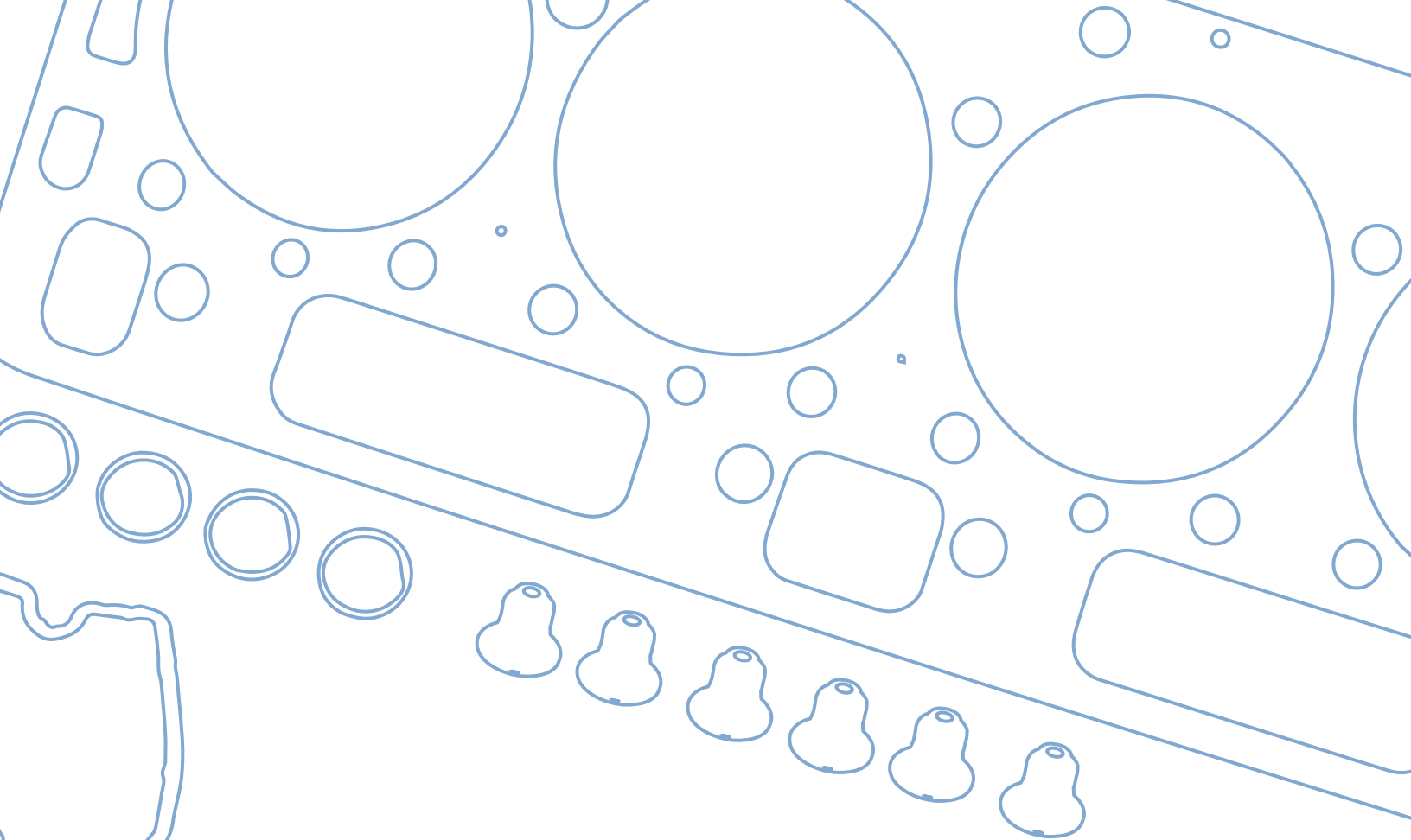

— RENAIULT —

**MARCA
/MAKE**

CATÁLOGO DE APLICACIONES / APPLICATION CATALOG

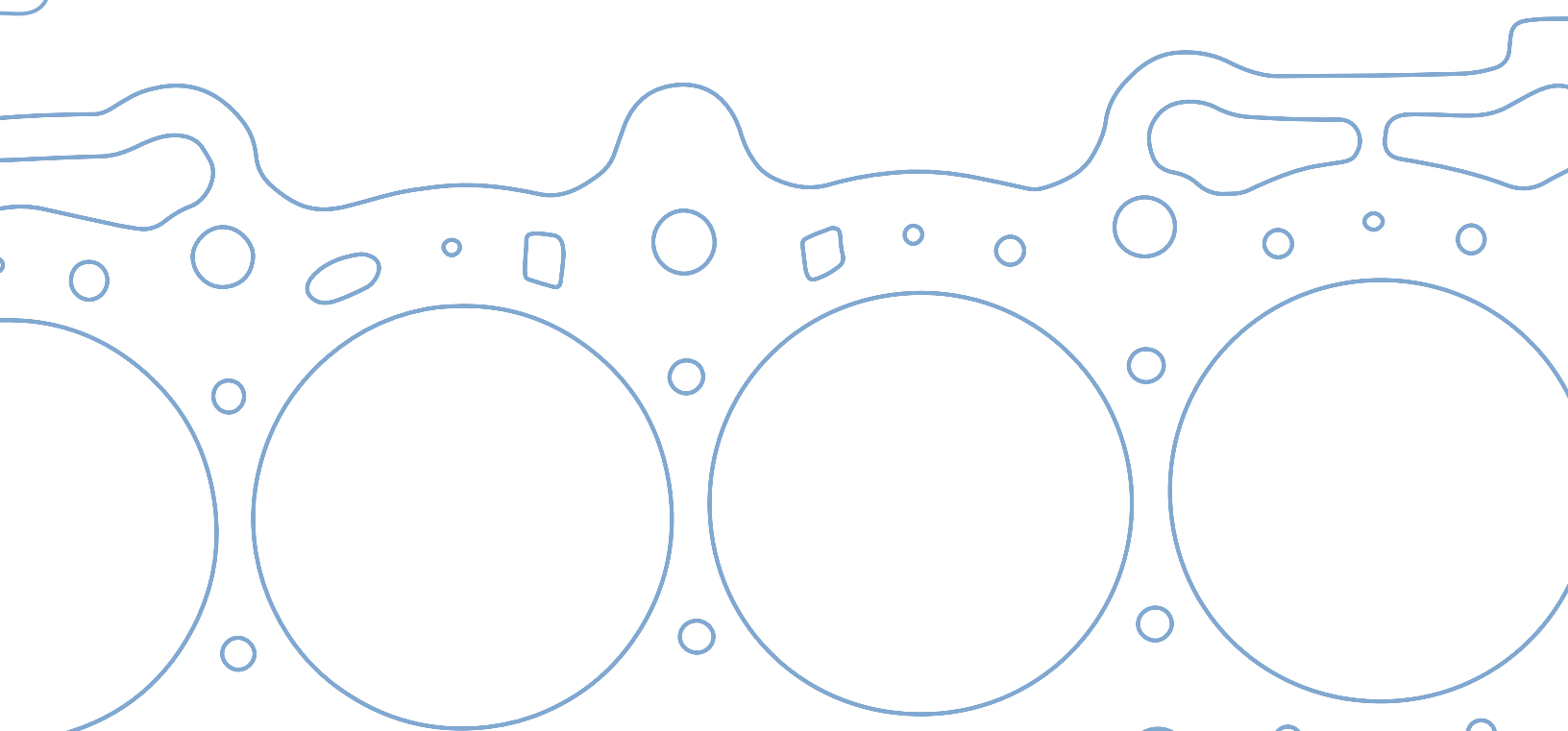





LITROS	MODELO	AÑO	PÁGINA
LITERS	MODEL	YEAR	PAGE
1.1L	R8, R10, MAJOR	1963/1969	177
1.3L	R5, R8, TL, TX, MIRAGE, 12 TL	1975/1984	177
1.6L	R12, R18, TS	1975/1984	178
1.6L	PLATINA, CLIO, KANGOO (CABEZA DE GRAFITO)	2002/2009	*
1.6L	PLATINA, CLIO, KANGOO	2002/2009	178



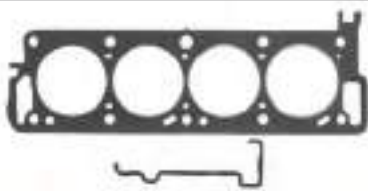

1.1L	MOTOR	MODELOS	DESDE / A	JUNTA DE CABEZA		MULTIPLE DE ADMISIÓN O PLENO	
ENGINE	MODELS	FROM / TO	HEAD GASKET		INTAKE		
4L OHV 8V	R8, R10, MAJOR	1963/1969	CA-1510-T		MS-41510-1		
FS-1510-1R			MULTIPLE DE ESCAPE		PUNTERIAS	CARTER	
			EXHAUST		VALVE COVER	OIL PAN	
			N/A		N/A	OS-11510-1	
			N/A		N/A		
DISTRIBUCIÓN		RETÉN CIGÜEÑAL		SELLOS DE VALVULA	N/A	JUNTAS VARIAS	
TIMING COVER		CRANK SEAL		STEM SEALS		MISCELLANEOUS	
TC-61510		BS-71800		N/A			

1.3L	MOTOR	MODELOS	DESDE / A	JUNTA DE CABEZA		MULTIPLE DE ADMISIÓN O PLENO	
ENGINE	MODELS	FROM / TO	HEAD GASKET		INTAKE		
4L OHV	R5, R8, TL, TX, MIRAGE, 12 TL	1975/1984	CA-1520-G		MS-41520		
FS-1520-1R			MULTIPLE DE ESCAPE		PUNTERIAS	CARTER	
			EXHAUST		VALVE COVER	OIL PAN	
					VS-31510-R	OS-11510	
DISTRIBUCIÓN		RETÉN CIGÜEÑAL		SELLOS DE VALVULA		JUNTAS VARIAS	
TIMING COVER		CRANK SEAL		STEM SEALS		MISCELLANEOUS	
TC-61510		BS-71300					



1.6L	MOTOR	MODELOS	DESDE / A	JUNTA DE CABEZA	MULTIPLE DE ADMISIÓN O PLENO
ENGINE	MODELS	FROM / TO	HEAD GASKET	INTAKE	
4L OHV	R12, R18, TS	1975/1984	CA-1530-G 	MS-41530 	
FS-1530					
DISTRIBUCIÓN		RETÉN CIGÜEÑAL	SELLOS DE VALVULA	JUNTAS VARIAS	
TIMING COVER		CRANK SEAL	STEM SEALS	MISCELLANEOUS	
TC-61530		BS-71300			

1.6L	MOTOR	MODELOS	DESDE / A	JUNTA DE CABEZA	MULTIPLE DE ADMISIÓN O PLENO
ENGINE	MODELS	FROM / TO	HEAD GASKET	INTAKE	
4L DOHC 16V K4M-690	PLATINA, CLIO, KANGOO	2002/2009	CA-1550-ML 	MS-41550 	
FS-1550					
DISTRIBUCIÓN		RETÉN CIGÜEÑAL	SELLOS DE VALVULA	JUNTAS VARIAS	
TIMING COVER		CRANK SEAL	STEM SEALS	MISCELLANEOUS	
		BS-71216	SS-81550-V		

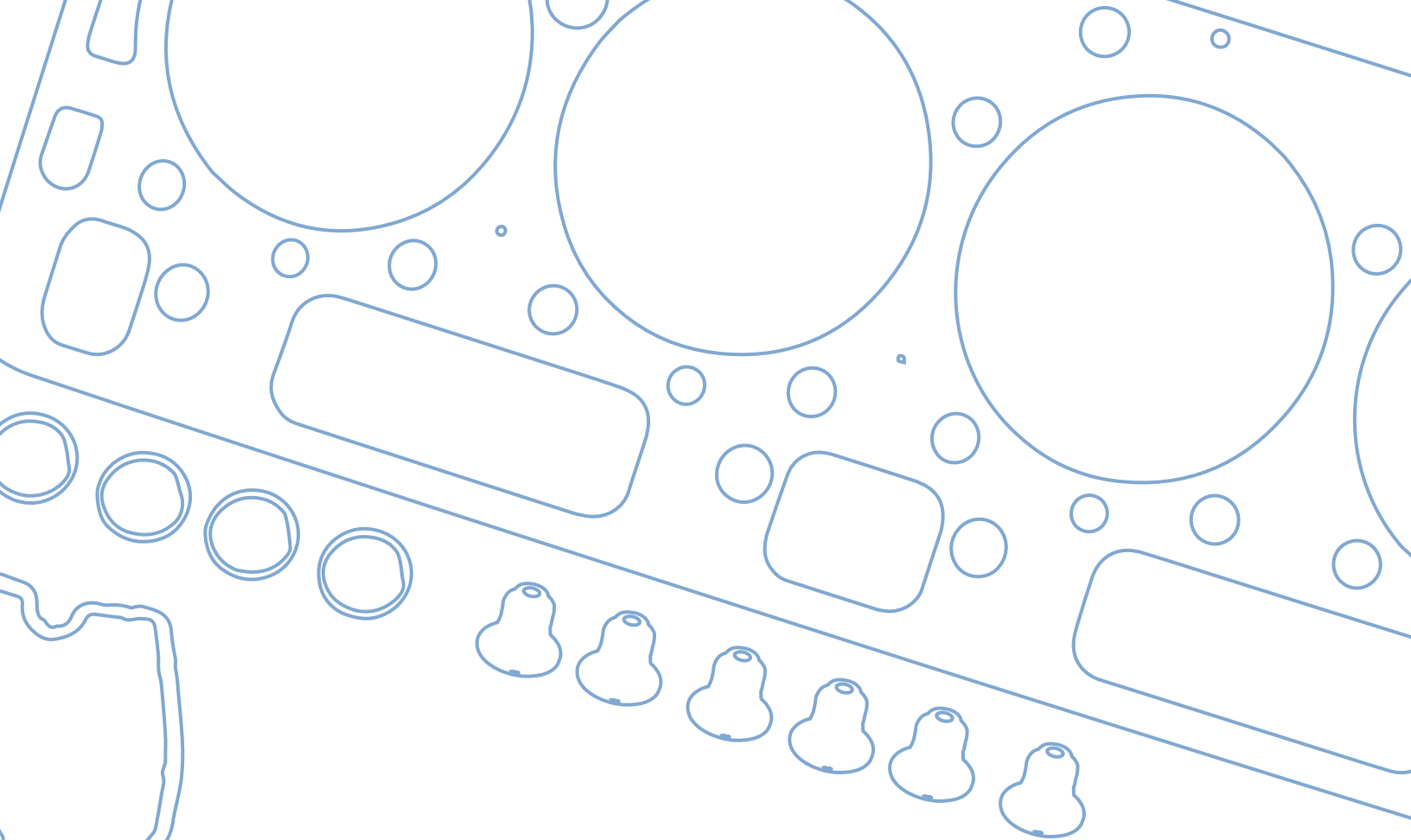

TOYOTA

**MARCA
/MAKE**

CATÁLOGO DE APLICACIONES / APPLICATION CATALOG

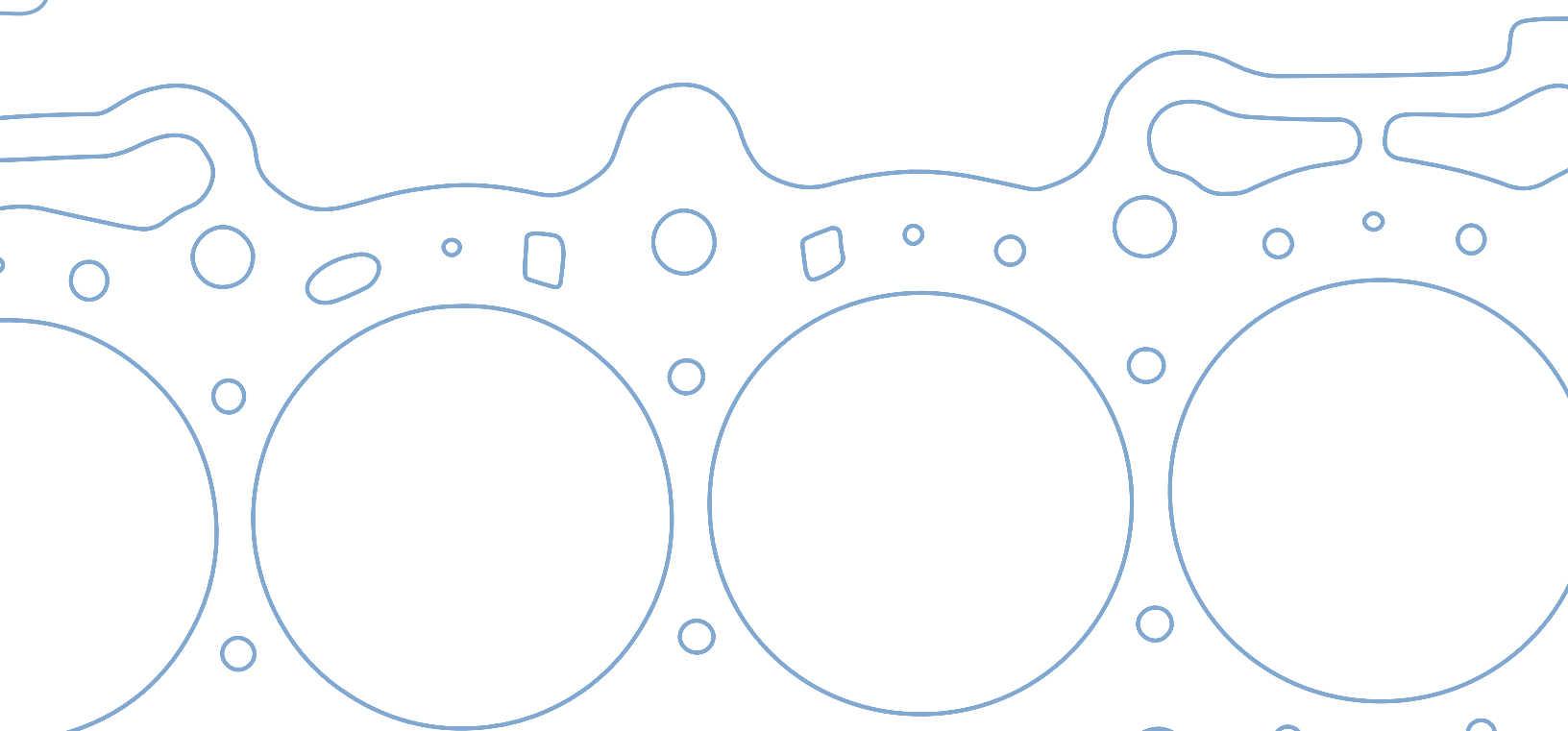

TOYOTA







LITROS	MODELO	AÑO	PÁGINA
LITERS	MODEL	YEAR	PAGE
1.5L	TERCEL.	1980/1988	*
1.5L	TERCEL.	1987/1994	*
1.5L	TERCEL, PASEO.	1992/1995	*
1.5L	TERCEL, PASEO.	1995/1999	*
1.6L	COROLLA, CARINA.	1977/1979	183
1.6L	COROLLA, CELICA, GEO PRIZM.	1988/1993	*
1.6L	COROLLA, PRIZM.	1993/1997	*
1.8L	CELICA, COROLLA, MR2, MATRIX, PONTIAC VIBE, PRIZM.	1998/2009	*
1.8L	COROLLA, CELICA, GEO PRIZM.	1993/1997	*
2.0L	CELICA, CAMRY.	1983/1986	*
2.0L	VAN CARGA.	1984/1985	*
2.0L	CAMRY, CELICA, MR2.	1987/1991	183
2.0L	RAV4.	2001/2003	184
2.2L	CELICA, CORONA PICK-UP.	1975/1980	184
2.2L	MR2 TURBO.	1991	*
2.2L	VAN CARGA / PASAJEROS.	1986/1989	185
2.2L	CAMRY, CELICA, MR2.	1991/1995	185
2.4L	PICK-UP, CORONA, CELICA.	1981/1982	186
2.4L	PICK UP, CELICA, 4RUNNER.	1983/1984	186
2.4L	PICK UP, CELICA, 4RUNNER.	1985/1995	187
2.4L	PREVIA.	1991/1997	*
2.4L	RAV4, CAMRY, HIGHLANDER.	2002/2007	*
2.4L	TACOMA.	1994/2004	*
2.7L	TACOMA, T-100, 4RUNNER.	1994/2004	*
2.7L	HIACE, HILUX, VENZA,	2005/2010	187
3.0L	4RUNNER, PICK-UP, T100.	1988/1995	188
3.0L	SUPRA, LEXUS SC300, IS300, GS300.	1993/1998	*
3.0L	CAMRY, LEXUS ES300.	1992/1993	*
3.0L	CAMRY, AVALON, SIENNA, SOLARA.	1994/2000	*
3.4L	TACOMA, 4RUNNER, T-100, TUNDRA.	1995/2004	188
4.0L	LEXUS LS400, SC400.	1990/1997	*
4.0L	LEXUS GS400, LS400, SC400.	1998/2000	*
4.0L	LAND CRUISER.	1988/1992	*
4.2L	LAND CRUISER.	1985/1987	*
4.7L	HINO SERIE 500.	2009/2014	189











1.6L	MOTOR	MODELOS	DESDE / A	JUNTA DE CABEZA	MULTIPLE DE ADMISIÓN O PLENO
ENGINE	MODELS	FROM / TO	HEAD GASKET	INTAKE	
4L OHV 8V.	COROLLA, CARINA.	1977/1979	CA-1301-B 	MS-41301 	
FS-1301 			MULTIPLE DE ESCAPE EXHAUST N/A	PUNTERIAS VALVE COVER VS-31301 	CARTER OIL PAN OS-11301
DISTRIBUCIÓN TIMING COVER TC-61301 	RETÉN CIGÜEÑAL CRANK SEAL BS-71301 	SELLOS DE VALVULA STEM SEALS SS-8250-N 	JUNTAS VARIAS MISCELLANEOUS N/A	N/A	

2.0L	MOTOR	MODELOS	DESDE / A	JUNTA DE CABEZA	MULTIPLE DE ADMISIÓN O PLENO
ENGINE	MODELS	FROM / TO	HEAD GASKET	INTAKE	
4L DOHC 16V, 3SFE.	CAMRY, CELICA, MR2.	1987/1991	CA-1322-ML 	MS-41322 	
FS-1324 			MULTIPLE DE ESCAPE EXHAUST MS-41322-E 	PUNTERIAS VALVE COVER VS-31322-R 	CARTER OIL PAN OS-11321
DISTRIBUCIÓN TIMING COVER TC-61322 	RETÉN CIGÜEÑAL CRANK SEAL BS-71321 	SELLOS DE VALVULA STEM SEALS SS-8109-S 	JUNTAS VARIAS MISCELLANEOUS		



2.0L	MOTOR	MODELOS	DESDE / A	JUNTA DE CABEZA	MULTIPLE DE ADMISIÓN O PLENO
ENGINE	MODELS	FROM / TO	HEAD GASKET	INTAKE	
4L DOHC 16V MOTOR1AZ-FE	RAV 4	2001/2003	CA-1325-ML 	MS-41325 	
FS-1325-ML 					
			MULTIPLE DE ESCAPE EXHAUST	PUNTERIAS VALVE COVER	CARTER OIL PAN
			MS-41325-E 	VS-31325-R 	OS-11325 
DISTRIBUCIÓN TIMING COVER		RETÉN CIGÜEÑAL CRANK SEAL	SELLOS DE VALVULA STEM SEALS	JUNTAS VARIAS MISCELLANEOUS	N/A
		BS-71325 		N/A	

2.2L	MOTOR	MODELOS	DESDE / A	JUNTA DE CABEZA	MULTIPLE DE ADMISIÓN O PLENO
ENGINE	MODELS	FROM / TO	HEAD GASKET	INTAKE	
4L SOHC 8V 20R	CELICA, CORONA PICK-UP.	1975/1980	CA-1310-G 	MS-41310 	
FS-1310 					
			MULTIPLE DE ESCAPE EXHAUST	PUNTERIAS VALVE COVER	CARTER OIL PAN
			MS-41310-E 	VS-31310-1R 	OS-11310 
DISTRIBUCIÓN TIMING COVER		RETÉN CIGÜEÑAL CRANK SEAL	SELLOS DE VALVULA STEM SEALS	JUNTAS VARIAS MISCELLANEOUS	N/A
TC-61310 		BS-71310 	SS-81310-N 	N/A	



2.2L	MOTOR	MODELOS	DESDE / A	JUNTA DE CABEZA	MULTIPLE DE ADMISIÓN O PLENO
ENGINE	MODELS	FROM / TO	HEAD GASKET	INTAKE	
4L SOHC 8V 4YEC "Y"	VAN CARGA / PASAJEROS.	1986/1989	CA-1326-G 	MS-41326 	
FS-1326-1G 			MULTIPLE DE ESCAPE EXHAUST N/A	PUNTERIAS VALVE COVER VS-31326-R 	CARTER OIL PAN OS-11301
DISTRIBUCIÓN TIMING COVER TC-61323 	RETÉN CIGÜEÑAL CRANK SEAL BS-71304 	SELLOS DE VALVULA STEM SEALS SS-81310-N 	JUNTAS VARIAS MISCELLANEOUS N/A	N/A	

2.2L	MOTOR	MODELOS	DESDE / A	JUNTA DE CABEZA	MULTIPLE DE ADMISIÓN O PLENO
ENGINE	MODELS	FROM / TO	HEAD GASKET	INTAKE	
4L DOHC 16V 5SFE.	CAMRY, CELICA, MR2.	1991/1995	CA-1322-ML 	MS-41322 	
FS-1324 			MULTIPLE DE ESCAPE EXHAUST MS-41322-E 	PUNTERIAS VALVE COVER VS-31322-R 	CARTER OIL PAN OS-11321
DISTRIBUCIÓN TIMING COVER TC-61322 	RETÉN CIGÜEÑAL CRANK SEAL BS-71321 	SELLOS DE VALVULA STEM SEALS SS-8109-S 	JUNTAS VARIAS MISCELLANEOUS		



2.4L	MOTOR	MODELOS	DESDE / A
ENGINE		MODELS	FROM / TO
4L SOHC 8V 22R,22REC		PICK-UP, CORONA, CELICA.	1981/1982



JUNTA DE CABEZA		MULTIPLE DE ADMISIÓN O PLENO
HEAD GASKET		INTAKE
CA-1320-GX		MS-41320

MULTIPLE DE ESCAPE	PUNTERIAS	CARTER
EXHAUST	VALVE COVER	OIL PAN
MS-41310-E	VS-31310-1R	OS-11310

DISTRIBUCIÓN
TIMING COVER
TC-61310

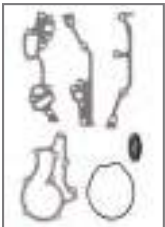

RETÉN CIGÜEÑAL
CRANK SEAL
BS-71310



SELLOS DE VALVULA
STEM SEALS
SS-81310-N



JUNTAS VARIAS
MISCELLANEOUS



2.4L	MOTOR	MODELOS	DESDE / A
ENGINE		MODELS	FROM / TO
4L SOHC 8V 22R,22REC.		PICK UP, CELICA, 4RUNNER.	1983/1984

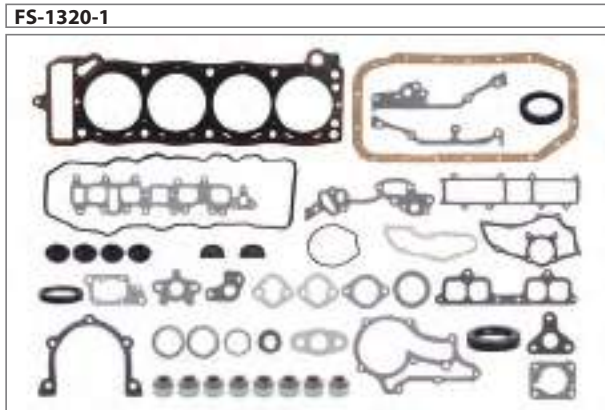

JUNTA DE CABEZA		MULTIPLE DE ADMISIÓN O PLENO
HEAD GASKET		INTAKE
CA-1320-GX		MS-41320-1

MULTIPLE DE ESCAPE	PUNTERIAS	CARTER
EXHAUST	VALVE COVER	OIL PAN
MS-41320-E	VS-31310-2R	OS-11310

DISTRIBUCIÓN
TIMING COVER
TC-61310

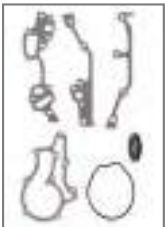

RETÉN CIGÜEÑAL
CRANK SEAL
BS-71310



SELLOS DE VALVULA
STEM SEALS
SS-81310-N



JUNTAS VARIAS
MISCELLANEOUS





2.4L	MOTOR	MODELOS	DESDE / A	JUNTA DE CABEZA	MULTIPLE DE ADMISIÓN O PLENO
ENGINE	MODELS	FROM / TO	HEAD GASKET	INTAKE	
4L SOHC 8V 22R,22REC.	PICK UP, CELICA, 4RUNNER.	1985/1995	CA-1320-GX 	MS-41320-1 	
FS-1320-2 			MULTIPLE DE ESCAPE EXHAUST MS-41320-1E 	PUNTERIAS VALVE COVER VS-31310-1R 	CARTER OIL PAN OS-11310
DISTRIBUCIÓN TIMING COVER TC-61310-1 	RETÉN CIGÜEÑAL CRANK SEAL BS-71310 	SELLOS DE VALVULA STEM SEALS SS-81310-N 	JUNTAS VARIAS MISCELLANEOUS 		

2.7L	MOTOR	MODELOS	DESDE / A	JUNTA DE CABEZA	MULTIPLE DE ADMISIÓN O PLENO
ENGINE	MODELS	FROM / TO	HEAD GASKET	INTAKE	
4L DOHC 16V 1ARFE, 2TRFE.	HIACE, HILUX, VENZA,	2005/2010	CA-1354-ML 		
FS-1354-ML 			MULTIPLE DE ESCAPE EXHAUST	PUNTERIAS VALVE COVER	CARTER OIL PAN
DISTRIBUCIÓN TIMING COVER	RETÉN CIGÜEÑAL CRANK SEAL	SELLOS DE VALVULA STEM SEALS	JUNTAS VARIAS MISCELLANEOUS		



3.0L	MOTOR	MODELOS	DESDE / A	JUNTA DE CABEZA	MULTIPLE DE ADMISIÓN O PLENO
ENGINE	MODELS	FROM / TO	HEAD GASKET	INTAKE	
V6 SOHC 12V 3VZE.	4RUNNER, PICK-UP, T100.	1988/1995	CA-1350-G / CA-1351-G	MS-41350	
<p>FS-1350</p>			<p>PARA VER IMAGEN DIRIGIRSE A SECCIÓN DE JUNTAS DE CABEZA.</p> <p>TO SEE IMAGE GO TO SECTION HEAD GASKETS</p>		
DISTRIBUCIÓN		RETÉN CIGÜEÑAL	SELLOS DE VALVULA	JUNTAS VARIAS	N/A
TIMING COVER		CRANK SEAL	STEM SEALS	MISCELLANEOUS	
TC-61350	BS-71350	SS-81350-V	N/A		

3.4L	MOTOR	MODELOS	DESDE / A	JUNTA DE CABEZA	MULTIPLE DE ADMISIÓN O PLENO
ENGINE	MODELS	FROM / TO	HEAD GASKET	INTAKE	
V6 DOHC 24V 5VZFE.	TACOMA, 4RUNNER, T-100, TUNDRA.	1995/2004	CA-1357-G / CA-1358-G	MS-41357	
<p>FS-1357</p>			<p>PARA VER IMAGEN DIRIGIRSE A SECCIÓN DE JUNTAS DE CABEZA.</p> <p>TO SEE IMAGE GO TO SECTION HEAD GASKETS</p>		
DISTRIBUCIÓN		RETÉN CIGÜEÑAL	SELLOS DE VALVULA	JUNTAS VARIAS	N/A
TIMING COVER		CRANK SEAL	STEM SEALS	MISCELLANEOUS	
	BS-71350	SS-81357-S	N/A		



4.7L	MOTOR	MODELOS	DESDE / A	JUNTA DE CABEZA		MULTIPLE DE ADMISIÓN O PLENO
ENGINE	MODELS	FROM / TO	HEAD GASKET	INTAKE		
4L HINO DIESEL 16V J05D-TG.	HINO SERIE 500.	2009/2014				
FS-1382						
			MULTIPLE DE ESCAPE EXHAUST		PUNTERIAS VALVE COVER	CARTER OIL PAN
DISTRIBUCIÓN TIMING COVER		RETÉN CIGÜEÑAL CRANK SEAL		SELLOS DE VALVULA STEM SEALS		JUNTAS VARIAS MISCELLANEOUS

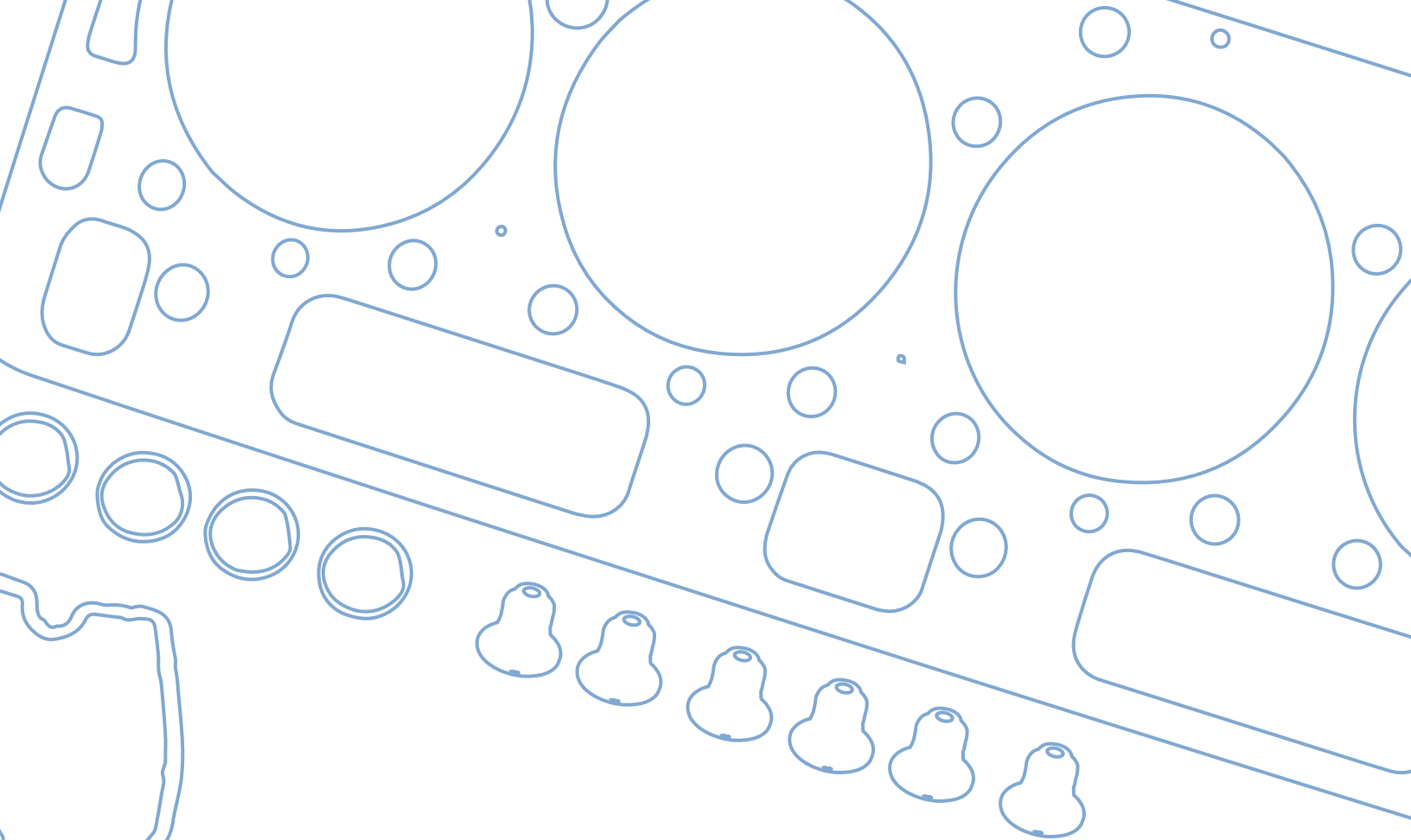

VOLKSWAGEN

VOLKSWAGEN

MARCA
/MAKE

CATÁLOGO DE APLICACIONES / APPLICATION CATALOG

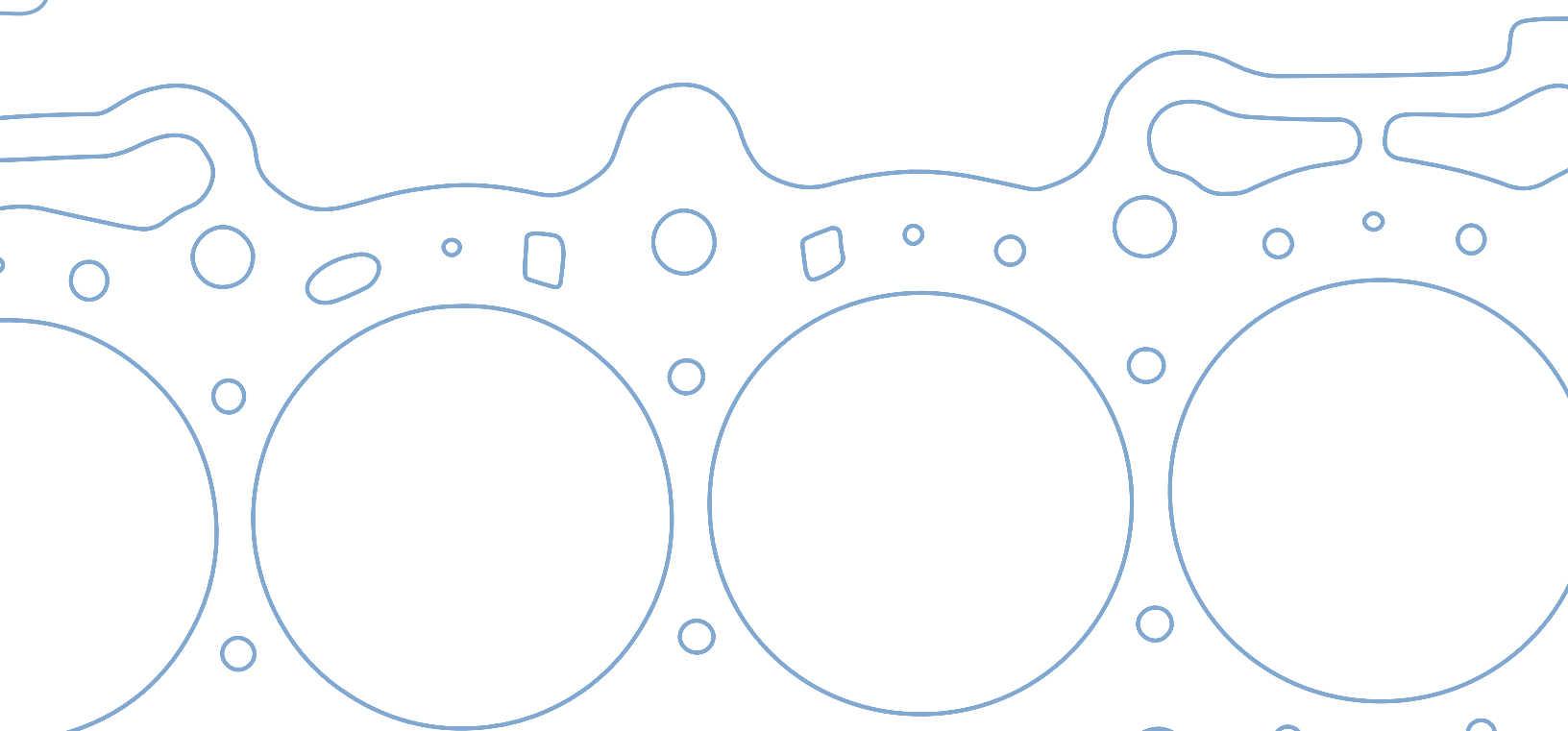

VOLKSWAGEN

LITROS	MODELO	AÑO	PÁGINA
LITERS	MODEL	YEAR	PAGE
1.2L	SEDAN	1963/1965	*
1.2L	SEDAN, COMBI	1961/1965	*
1.5L	SEDAN, COMBI	1969/1972	*
1.6L	SEDAN, COMBI	1968/1985	195
1.6L	SEDAN, COMBI, BRASILIA	1986/2003	195
1.6L	VARIANT, ATLANTIC, CARIBE	1977/1986	196
1.6L	LUPO, POLO, CROSSFOX, SPORT VAN, GOL	2003/2014	196
1.7L	ATLANTIC, CARIBE, VARIANT	1977/1986	197
1.7L	CARIBE, ATLANTIC, RABBIT, SCIROCCO	1978/1987	197
1.8L	JETTA A2, GOLF, CORSAR, CABRIOLET, RABBIT	1983/1998	198
1.8L	POINTER, POINTER PICK UP	1998/2002	198
1.8L	PASSAT, BEETLE, SHARAN, JETTA GLI, AUDI A4, A3	2001/2012	199
1.8L	PASSAT, BEETLE, AUDI A4, A3	1995/2000	199
1.8L	PASSAT, AUDI A4, GOLF, BEETLE,	1996/2005	*
1.9L	EUROVAN, TRANSPORTER	2006/2009	*
2.0L	JETTA A3, GOLF, CABRIO	1993/1999	200
2.0L	JETTA A3, GOLF, CABRIO (CABEZA EN MLS)	1993/1999	*
2.0L	JETTA A3, GOLF, POINTER GTI	1999/2000	200
2.0L	JETTA A4, GOLF, BEETLE, IBIZA (CABEZA EN GRAFITO)	2000/2007	201
2.0L	JETTA A4, GOLF, BEETLE, IBIZA (CABEZA EN MLS)	2000/2007	201
2.0L	PASSAT, JETTA GLI	2010/2013	*
2.5L	EUROVAN	2001/2004	202
2.5L	BORA, BEETLE	2005/2010	202
2.5L	EUROVAN, TRANSPORTER	2001/2004	*
2.8L	PASSAT, AUDI A4 y A6	1997/2001	*
2.8L	JETTA VR6, TRANSPORTER, SHARAN, GOLF GTI	1992/2003	*



1.6L	MOTOR	MODELOS	DESDE / A	JUNTA DE CABEZA	MULTIPLE DE ADMISIÓN O PLENO
ENGINE	MODELS	FROM / TO	HEAD GASKET	INTAKE	
H4 8V BOXER	SEDAN, COMBI	1968/1985			MS-41812
FS-1820					
			MULTIPLE DE ESCAPE	PUNTERIAS	CARTER
			EXHAUST	VALVE COVER	OIL PAN
			MS-41810	VS-31810	OS-11810
DISTRIBUCIÓN		RETÉN CIGÜEÑAL	SELLOS DE VALVULA	JUNTAS VARIAS	
TIMING COVER		CRANK SEAL	STEM SEALS	MISCELLANEOUS	
RE-16077		BS-71800			

1.6L	MOTOR	MODELOS	DESDE / A	JUNTA DE CABEZA	MULTIPLE DE ADMISIÓN O PLENO
ENGINE	MODELS	FROM / TO	HEAD GASKET	INTAKE	
H4 8V BOXER	SEDAN, COMBI, BRASILIA	1986/2003			MS-41812
FS-1820-1					
			MULTIPLE DE ESCAPE	PUNTERIAS	CARTER
			EXHAUST	VALVE COVER	OIL PAN
			MS-41810	VS-31810	OS-11810
DISTRIBUCIÓN		RETÉN CIGÜEÑAL	SELLOS DE VALVULA	JUNTAS VARIAS	
TIMING COVER		CRANK SEAL	STEM SEALS	MISCELLANEOUS	
RE-16077		BS-71800			



1.6L	MOTOR	MODELOS	DESDE / A	JUNTA DE CABEZA	MÚLTIPLE DE ADMISIÓN O PLENO
ENGINE	MODELS	FROM / TO	HEAD GASKET	INTAKE	
4L SOHC 8V CARB	VARIANT, ATLANTIC, CARIBE	1977/1986	<p>CA-1830-G</p>	<p>MS-41830-A</p>	
<p>FS-1830-1</p>			<p>MÚLTIPLE DE ESCAPE</p> <p>EXHAUST</p> <p>MS-41830-E</p>	<p>PUNTERIAS</p> <p>VALVE COVER</p> <p>VS-31830</p>	<p>CARTER</p> <p>OIL PAN</p> <p>OS-11830</p>
<p>DISTRIBUCIÓN</p> <p>TIMING COVER</p> <p>TC-61830-2</p>	<p>RETÉN CIGÜEÑAL</p> <p>CRANK SEAL</p> <p>BS-71830</p>	<p>SELLOS DE VALVULA</p> <p>STEM SEALS</p> <p>SS-81830</p>	<p>JUNTAS VARIAS</p> <p>MISCELLANEOUS</p>		

1.6L	MOTOR	MODELOS	DESDE / A	JUNTA DE CABEZA	MÚLTIPLE DE ADMISIÓN O PLENO
ENGINE	MODELS	FROM / TO	HEAD GASKET	INTAKE	
4L SOHC 8V	LUPO, POLO, CROSSFOX, SPORT VAN, GOL	2003/2014	<p>CA-1835-G</p>	<p>MS-41835-A</p>	
<p>FS-1835-G</p>			<p>MÚLTIPLE DE ESCAPE</p> <p>EXHAUST</p> <p>MS-41835-E</p>	<p>PUNTERIAS</p> <p>VALVE COVER</p>	<p>CARTER</p> <p>OIL PAN</p>
<p>DISTRIBUCIÓN</p> <p>TIMING COVER</p> <p>TC-61835</p>	<p>RETÉN CIGÜEÑAL</p> <p>CRANK SEAL</p> <p>BS-71835-AT</p>	<p>SELLOS DE VALVULA</p> <p>STEM SEALS</p> <p>SV-81852-V</p>	<p>JUNTAS VARIAS</p> <p>MISCELLANEOUS</p>		



1.7L	MOTOR	MODELOS	DESDE / A	JUNTA DE CABEZA	MULTIPLE DE ADMISIÓN O PLENO
ENGINE	MODELS	FROM / TO	HEAD GASKET	INTAKE	
4L SOHC 8V CARB	ATLANTIC, CARIBE, VARIANT	1977/1986	CA-1830-G 	MS-41830-A 	
FS-1830-1 			MULTIPLE DE ESCAPE EXHAUST MS-41830-E 	PUNTERIAS VALVE COVER VS-31830 	CARTER OIL PAN OS-11830
DISTRIBUCIÓN TIMING COVER TC-61830-2 	RETÉN CIGÜEÑAL CRANK SEAL BS-71830 	SELLOS DE VALVULA STEM SEALS SS-81830 	JUNTAS VARIAS MISCELLANEOUS 		

1.7L	MOTOR	MODELOS	DESDE / A	JUNTA DE CABEZA	MULTIPLE DE ADMISIÓN O PLENO
ENGINE	MODELS	FROM / TO	HEAD GASKET	INTAKE	
4L SOHC 8V CARB	CARIBE, ATLANTIC, RABBIT, SCIROCCO	1978/1987	CA-1830-G 	MS-41830-1 	
FS-1830-2 			MULTIPLE DE ESCAPE EXHAUST MS-41830-E 	PUNTERIAS VALVE COVER VS-31830 	CARTER OIL PAN OS-11830
DISTRIBUCIÓN TIMING COVER TC-61830-1 	RETÉN CIGÜEÑAL CRANK SEAL BS-71830 	SELLOS DE VALVULA STEM SEALS SS-81830 	JUNTAS VARIAS MISCELLANEOUS 		



1.8L	MOTOR	MODELOS	DESDE / A
ENGINE		MODELS	FROM / TO
4L SOHC 8V CARB & FI		JETTA A2, GOLF, CORSAR, CABRIO-LET, RABBIT	1983/1998

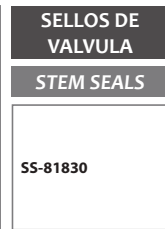
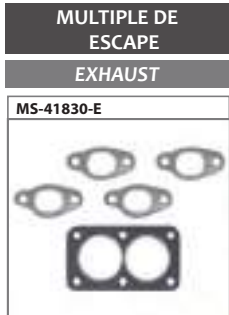

1.8L	MOTOR	MODELOS	DESDE / A
ENGINE		MODELS	FROM / TO
4L SOHC 8V AVH AZG		POINTER, POINTER PICK UP	1998/2002

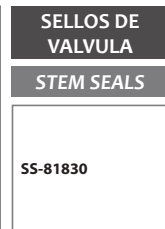
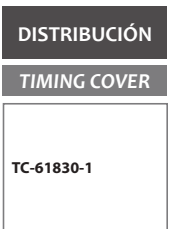
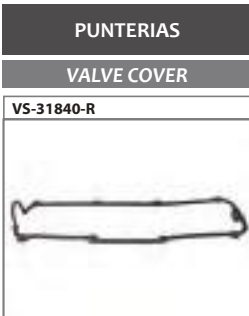
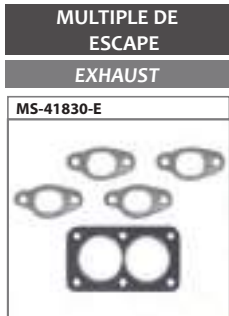
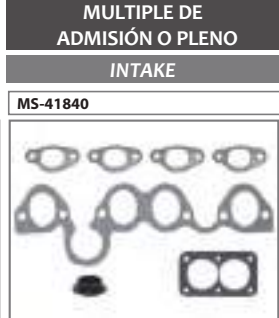
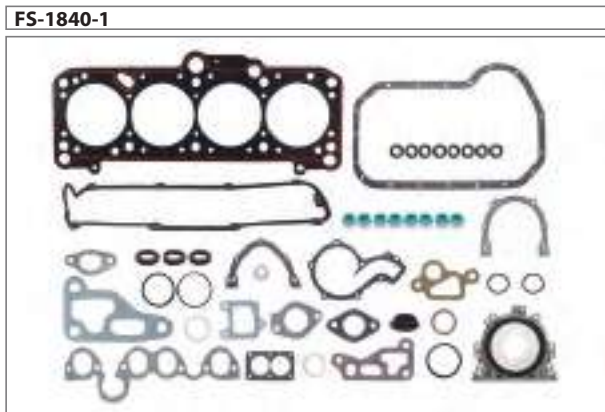



1.8L	MOTOR	MODELOS	DESDE / A	JUNTA DE CABEZA	MULTIPLE DE ADMISIÓN O PLENO
ENGINE	MODELS	FROM / TO	HEAD GASKET	INTAKE	
4L DOHC 20V TURBO ADR ANB AFY	PASSAT, BEETLE, SHARAN, JETTA GLI, AUDI A4, A3	2001/2012	CA-1852-ML 	MS-41852-A 	
FS-1852 			MULTIPLE DE ESCAPE EXHAUST	PUNTERIAS VALVE COVER	CARTER OIL PAN
DISTRIBUCIÓN TIMING COVER	RETÉN CIGÜEÑAL CRANK SEAL	SELLOS DE VALVULA STEM SEALS	JUNTAS VARIAS MISCELLANEOUS	MS-41852-E 	VS-31852-R
TC-61830-1 	BS-71840-AT 	SV-81852-V 		OS-11852-1 	

1.8L	MOTOR	MODELOS	DESDE / A	JUNTA DE CABEZA	MULTIPLE DE ADMISIÓN O PLENO
ENGINE	MODELS	FROM / TO	HEAD GASKET	INTAKE	
4L DOHC 20V TURBO AEB APH	PASSAT, BEETLE, AUDI A4, A3	1995/2000	CA-1852-1ML 	MS-41852-1A 	
FS-1852-1 			MULTIPLE DE ESCAPE EXHAUST	PUNTERIAS VALVE COVER	CARTER OIL PAN
DISTRIBUCIÓN TIMING COVER	RETÉN CIGÜEÑAL CRANK SEAL	SELLOS DE VALVULA STEM SEALS	JUNTAS VARIAS MISCELLANEOUS	MS-41852-E 	VS-31852-R
TC-61830-1 	BS-71840-AT 	SV-81852-V 		OS-11852-1 	



2.0L	MOTOR	MODELOS	DESDE / A	JUNTA DE CABEZA	MULTIPLE DE ADMISIÓN O PLENO
ENGINE	MODELS	FROM / TO	HEAD GASKET	INTAKE	
4L SOHC 8V ABA	JETTA A3, GOLF, CABRIO	1993/1999	CA-1845-G 	MS-41845 	
FS-1845 			MULTIPLE DE ESCAPE EXHAUST	PUNTERIAS VALVE COVER	CARTER OIL PAN
			MS-41845-E 	VS-31830 	OS-11830
DISTRIBUCIÓN TIMING COVER		RETÉN CIGÜEÑAL CRANK SEAL		SELLOS DE VALVULA STEM SEALS	JUNTAS VARIAS MISCELLANEOUS
TC-61830-3		BS-071845-AT		SS-81845 	

2.0L	MOTOR	MODELOS	DESDE / A	JUNTA DE CABEZA	MULTIPLE DE ADMISIÓN O PLENO
ENGINE	MODELS	FROM / TO	HEAD GASKET	INTAKE	
4L SOHC 8V	JETTA A3, GOLF, POINTER GTI	1999/2000	CA-1845-G 	MS-41845 	
FS-1845-1 			MULTIPLE DE ESCAPE EXHAUST	PUNTERIAS VALVE COVER	CARTER OIL PAN
			MS-41845-E 	VS-31840-R 	OS-11830
DISTRIBUCIÓN TIMING COVER		RETÉN CIGÜEÑAL CRANK SEAL		SELLOS DE VALVULA STEM SEALS	JUNTAS VARIAS MISCELLANEOUS
TC-61830-3		BS-71845-AT		SS-81845 	



2.0L	MOTOR	MODELOS	DESDE / A	JUNTA DE CABEZA	MULTIPLE DE ADMISIÓN O PLENO
ENGINE	MODELS	FROM / TO	HEAD GASKET	INTAKE	
4L SOHC 8V AEG AVH AZG	JETTA A4, GOLF, BEETLE, IBIZA (CABEZA EN GRAFITO)	2000/2007	CA-1850-G	MS-41850	
FS-1850-G 			 	 	
			MULTIPLE DE ESCAPE	PUNTERIAS	CARTER
			EXHAUST	VALVE COVER	OIL PAN
			MS-41845-E	VS-31850-R	OS-11850
DISTRIBUCIÓN	RETÉN CIGÜEÑAL	SELLOS DE VALVULA	JUNTAS VARIAS	 	
TIMING COVER	CRANK SEAL	STEM SEALS	MISCELLANEOUS		
TC-61850	BS-71840-AT	SV-81845-V			

2.0L	MOTOR	MODELOS	DESDE / A	JUNTA DE CABEZA	MULTIPLE DE ADMISIÓN O PLENO
ENGINE	MODELS	FROM / TO	HEAD GASKET	INTAKE	
4L SOHC 8V AEG AVH AZG	JETTA A4, GOLF, BEETLE, IBIZA (CABEZA EN MLS)	2000/2007	CA-1850-ML	MS-41850-R	
FS-1850-ML 			 	 	
			MULTIPLE DE ESCAPE	PUNTERIAS	CARTER
			EXHAUST	VALVE COVER	OIL PAN
			MS-41845-E	VS-31850-R	OS-11850
DISTRIBUCIÓN	RETÉN CIGÜEÑAL	SELLOS DE VALVULA	JUNTAS VARIAS	 	
TIMING COVER	CRANK SEAL	STEM SEALS	MISCELLANEOUS		
TC-61850	BS-71840-AT	SV-81845-V			



2.5L	MOTOR	MODELOS	DESDE / A	JUNTA DE CABEZA	MULTIPLE DE ADMISIÓN O PLENO
ENGINE	MODELS	FROM / TO	HEAD GASKET	INTAKE	
5L, SOHC 20V	EUROVAN	2001/2004	CA-1851-B 	MS-41851 	
FS-1851 			MULTIPLE DE ESCAPE EXHAUST MS-41851-E 	PUNTERIAS VALVE COVER VS-31851-R 	CARTER OIL PAN OS-11851
DISTRIBUCIÓN TIMING COVER TC-61850 	RETÉN CIGÜEÑAL CRANK SEAL BS-71830 	SELLOS DE VALVULA STEM SEALS SS-81830 	JUNTAS VARIAS MISCELLANEOUS		

2.5L	MOTOR	MODELOS	DESDE / A	JUNTA DE CABEZA	MULTIPLE DE ADMISIÓN O PLENO
ENGINE	MODELS	FROM / TO	HEAD GASKET	INTAKE	
5L DOHC 20V CBTA CBUA BGP	BORA, BEETLE	2005/2010	CA-1856-ML 	MS-41856-A 	
FS-1856-ML 			MULTIPLE DE ESCAPE EXHAUST MS-41856-E 	PUNTERIAS VALVE COVER VS-31856-R 	CARTER OIL PAN
DISTRIBUCIÓN TIMING COVER TC-61856 	RETÉN CIGÜEÑAL CRANK SEAL BS-71856-PT 	SELLOS DE VALVULA STEM SEALS SS-81856-V 	JUNTAS VARIAS MISCELLANEOUS		

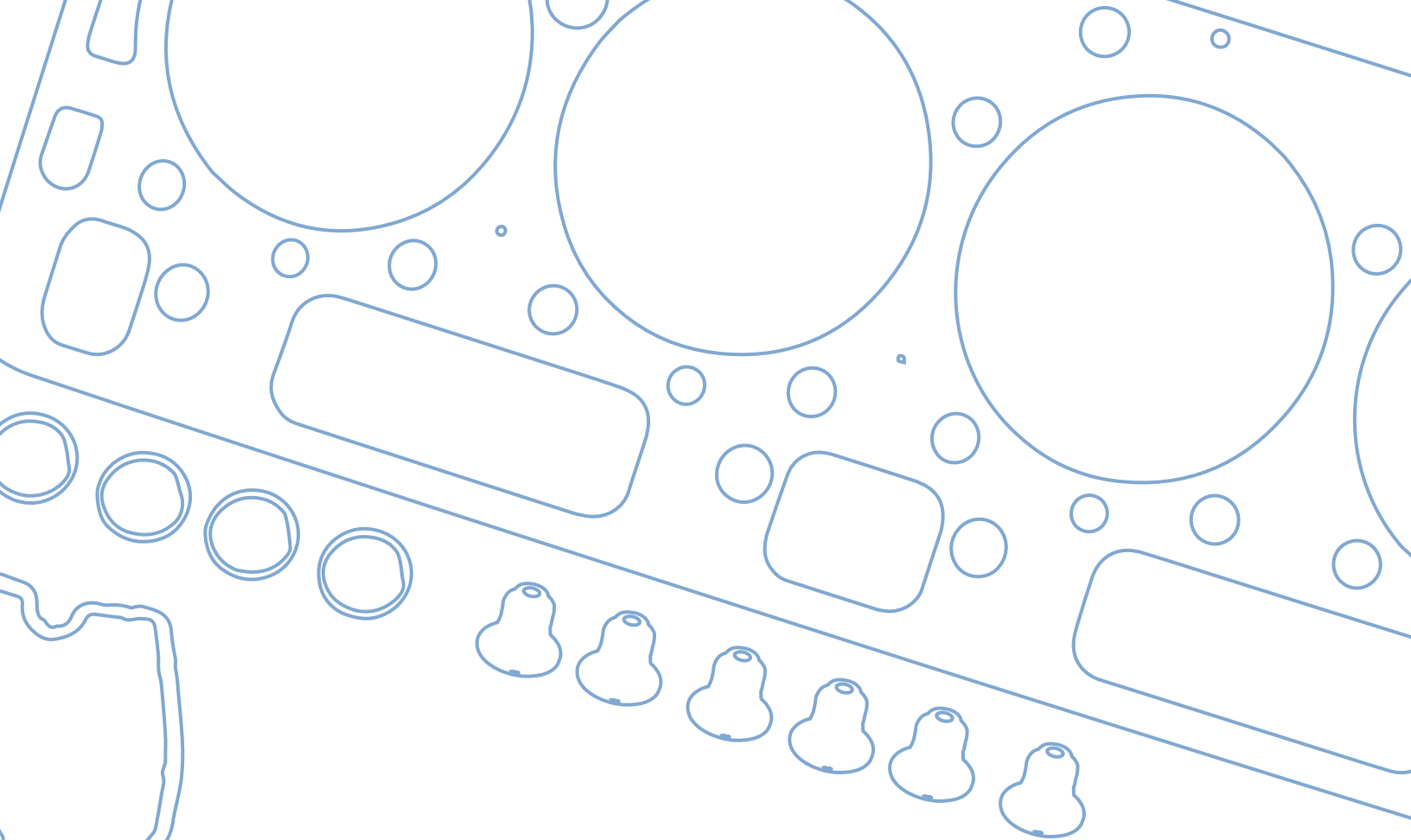

— ■ **JUNTAS DE CABEZA**
/ HEAD GASKETS

SECCIÓN
/SECTION

CATÁLOGO DE APLICACIONES / APPLICATION CATALOG

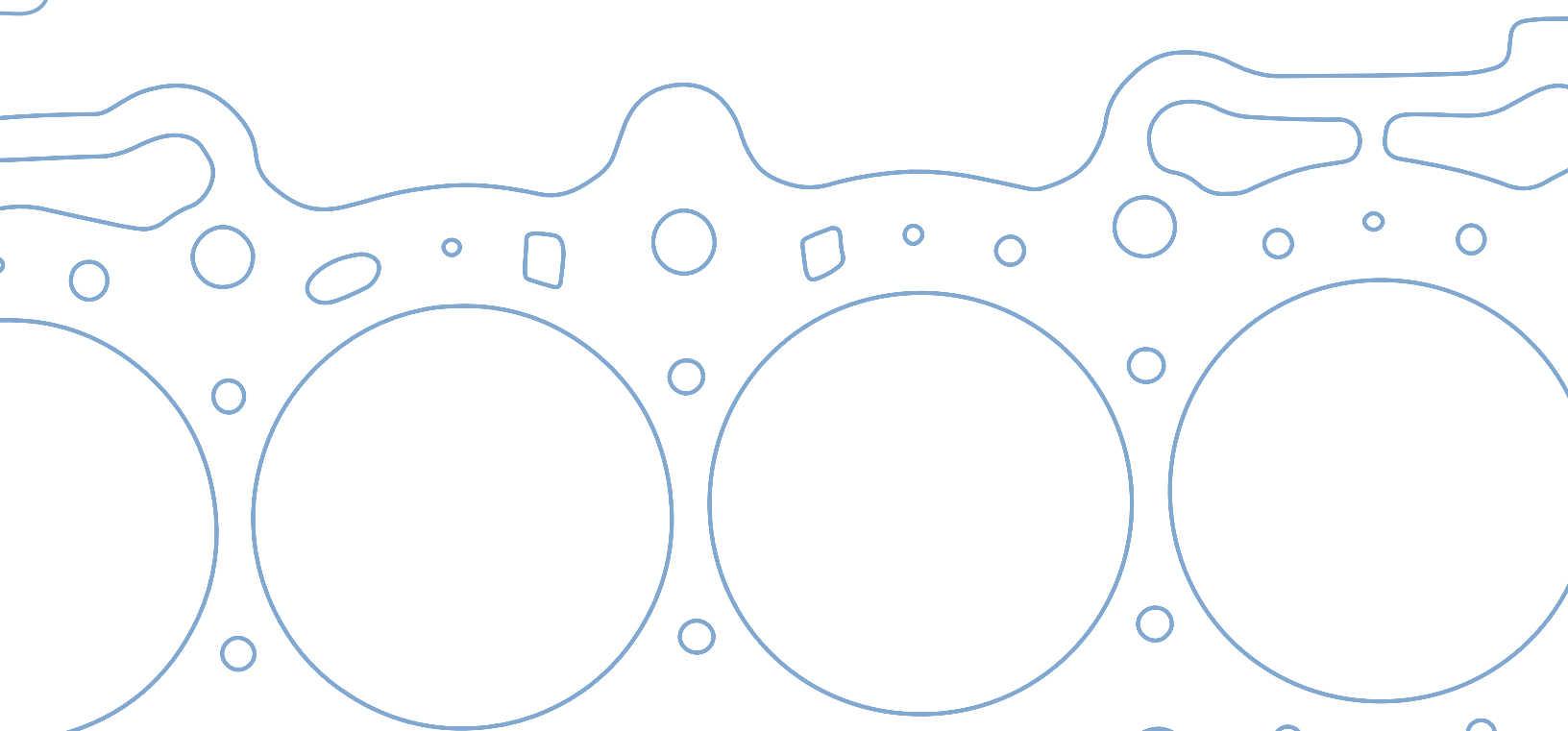

LITROS	Numero DC	MODELO	AÑO	PÁGINA
LITERS	DC Number	MODEL	YEAR	PAGE
1.0L	CA-95-G	SPRINT, FIREFLY, FORSA.	1985/1988	*
1.0L	CA-95-1G	GEO METRO, SWIFT.	1989/1997	1
1.0L	CA-116-G	MATIZ G2.	2004/2010	1
1.0L	CA-201-G	ATOS.	2000/2003	1
1.1L	CA-201-1G	ATOS.	2004/2009	1
1.2L	CA-119-ML	SPARK.	2011/2013	1
1.2L	CA-207-ML	i 10.	2012/2014	1
1.2L	CA-1200-G	AUTOS & CAMIONETAS.	1959/1969	*
1.2L	CA-1213-G	AUTOS AMERICANOS.	1980/1982	1
1.3L	CA-302-G	FIESTA.	1997/2001	1
1.3L	CA-1200-G	AUTOS & CAMIONETAS.	1959/1969	*
1.3L	CA-1450-G	CIVIC.	1984/1987	*
1.4L	CA-100-G	CHEVY POP, JOY, SWING.	1994/2001	1
1.4L	CA-101-G	PONTIAC ACADIAN, T1000, CHEVETTE.	1976/1987	*
1.4L	CA-204-ML	ATTITUDE.	2006/2011	1
1.4L	CA-230-G	COLT, MIRAGE, EXCEL.	1979/1991	1
1.4L	CA-307-ML	FIESTA.	1998/2001	*
1.4L	CA-307-G	FIESTA.	1998/2000	1
1.4L	CA-1213-G	AUTOS AMERICANOS.	1979/1982	1
1.4L	CA-1901-G	PEUGEOT 206,PARTNER.	2000/2007	1
1.5L	CA-203-ML	VERNA.	2000/2006	1
1.5L	CA-209-ML	MIRAGE.	1997/2002	*
1.5L	CA-230-G	COLT, MIRAGE, EXCEL.	1979/1984	1
1.5L	CA-1210-G	DATSUN PICK UP, VAGONETA, SEDAN.	1970/1983	*
1.5L	CA-1213-G	AUTOS AMERICANOS.	1979/1982	1
1.5L	CA-1216-G	TSURU I.	1984/1987	1
1.5L	CA-1304-G	TERCEL.	1987/1994	*
1.5L	CA-1305-ML	TERCEL, PASEO.	1992/1995	*
1.5L	CA-1305-1G	TERCEL, PASEO.	1995/1999	*
1.5L	CA-1450-G	CIVIC.	1984/1991	*
1.5L	CA-1452-G	CIVIC (CABEZA DE GRAFITO).	1988/1995	*
1.6L	CA-100-1G	CHEVY MONZA, PICK-UP.	1996/2010	1
1.6L	CA-101-G	PONTIAC ACADIAN, T1000, CHEVETTE.	1976/1987	*
1.6L	CA-102-1G	AVEO, PONTIAC G3 (CABEZA DE GRAFITO).	2008/2012	1
1.6L	CA-102-1ML	AVEO, PONTIAC G3 (CABEZA DE MLS).	2008/2012	1
1.6L	CA-103-G	CHEVY NOVA.	1986/1988	*
1.6L	CA-317-G	FIESTA, IKON, Ka, COURIER.	2001/2010	1
1.6L	CA-324-ML	MAZDA 3.	2006/2007	1
1.6L	CA-402-G	TRACKER, SIDEKICK, SWIFT.	1989/2002	1
1.6L	CA-1107-G	MIATA, CAPRI, 323, MX-5.	1988/1994	*
1.6L	CA-1216-G	TSURU II.	1987/1991	1
1.6L	CA-1226-G	200S SX, SENTRA , TSURU GS1, TSUBAME, LUCINO.	1991/1996	1
1.6L	CA-1226-1G	TSURU GSI, GSII, SENTRA MEXICO, TSUBAME.	1997/2014	1
1.6L	CA-1227-G	SENTRA AMERICANO, PULSAR NX.	1989/1990	1
1.6L	CA-1242-2ML	MARCH, VERSA.	2012/2014	1
1.6L	CA-1307-G	COROLLA , PRIZM.	1993/1997	*
1.6L	CA-1454-G	CIVIC DEL SOL.	1994/2000	*
1.6L	CA-1455-ML	CIVIC , ACURA EL (CABEZA DE MLS).	1996/2000	1

LITROS	Numero DC	MODELO	AÑO	PÁGINA
LITERS	DC Number	MODEL	YEAR	PAGE
1.6L	CA-1455-G	CIVIC. ACURA EL (CABEZA DE GRAFITO).	1996/2000	*
1.6L	CA-1530-G	R12, R18, TS.	1975/1984	1
1.6L	CA-1550-ML	PLATINA, CLIO, KANGOO CABEZA DE MLS).	2002/2009	1
1.6L	CA-1550-G	PLATINA, CLIO, KANGOO, (CABEZA DE GRAFITO).	2002/2009	1
1.6L	CA-1835-G	LUPO, POLO, CROSSFOX, SPORT VAN, GOL.	2003/2014	1
1.6L	CA-1835-ML	LUPO, POLO, CROSSFOX, (CABEZA MLS).	2005/2012	*
1.6L	CA-1900-ML	PEUGEOT 206.	2000/2008	1
1.7L	CA-1459-G	CIVIC, ACURA EL.	2001/2005	*
1.8L	CA-102-G	S10, PICK-UP, BLAZER, TROOPER.	1972/1982	*
1.8L	CA-104-G	CAVALIER, FIRENZA, SKYHAWK, SUNBIRD.	1982	*
1.8L	CA-107-G	SUNBIRD, FIRENZA, J2000.	1982/1986	*
1.8L	CA-114-G	ASTRA, ZAFIRA, (CABEZA DE GRAFITO).	2000/2008	*
1.8L	CA-114-ML	ASTRA HATCHBACK (CABEZA DE MLS).	2000/2008	*
1.8L	CA-118-G	CORSA, PICK-UP TORNADO.	2003/2006	1
1.8L	CA-122-ML	CRUZE, (CABEZA DE MLS).	2011/2013	1
1.8L	CA-122-G	CRUZE (CABEZA DE GRAFITO).	2011/2013	1
1.8L	CA-205-ML	MIRAGE	1997/2002	*
1.8L	CA-205-G	EXPO, COLT, MIRAGE	1993/1996	*
1.8L	CA-208-ML	ELANTRA, TIBURON	1998/2002	*
1.8L	CA-237-G	ECLIPSE, TALON, COLT, LASER.	1989/1994	1
1.8L	CA-303-2ML	ESCORT, TRACER.	1991/1996	1
1.8L	CA-1111-2ML	MIATA.	2001/2005	*
1.8L	CA-1214-G	200SX, STANZA.	1982/1988	*
1.8L	CA-1215-G	SAKURA, ESTAQUITAS, PICK-UP USA, ICHIVAN.	1981/1993	1
1.8L	CA-1234-ML	SENTRA (CABEZA DE MLS).	2000/2003	*
1.8L	CA-1234-G	SENTRA, (CABEZA DE GRAFITO).	2000/2003	1
1.8L	CA-1238-G	TIIDA, SENTRA, VERSA.	2007/2011	1
1.8L	CA-1302-ML	CELICA, COROLLA, MR2, MATRIX, PONTIAC VIBE, PRIZM.	1998/2009	*
1.8L	CA-1307-ML	COROLLA, CELICA, GEO PRIZM.	1993/1997	*
1.8L	CA-1454-G	ACURA INTEGRA.	1994/2001	*
1.8L	CA-1458-ML	ACURA INTEGRA.	1990/1995	1
1.8L	CA-1480-ML	CIVIC EX, DX, LXS.	2006/2009	*
1.8L	CA-1840-G	JETTA A2, GOLF, CORSAR, CABRIOLET, RABBIT.	1983/1998	1
1.8L	CA-1852-ML	PASSAT, BEETLE, SHARAN, JETTA GLI, AUDI A4, A3.	2001/2012	1
1.8L	CA-1852-G	PASSAT, AUDI A4, GOLF, BEETLE.	1996/2005	*
1.9L	CA-102-G	S10, PICK-UP, BLAZER, TROOPER.	1982/1985	*
1.9L	CA-111-G	SATURN.	1991/2002	1
1.9L	CA-115-G	SATURN SC2, SL2, SC, SL2.	1991/1995	1
1.9L	CA-303-G	MERCURY TRACER, ESCORT.	1981/1999	1
1.9L	CA-303-2G	ESCORT TRACER.	1991/1996	1
1.9L	CA-1860-ML	EUROVAN, TRANSPORTER.	2006/2009	*
2.0L	CA-104-G	CAVALIER, FIRENZA, SKYHAWK, SUNBIRD.	1983/1987	*
2.0L	CA-107-G	J2000, SUNBIRD.	1982/1986	*
2.0L	CA-108-G	CAVALIER USA, PICK-UP S10, BLAZER, BERETTA, CORSICA.	1987/1989	1
2.0L	CA-117-ML	OPTRA, ASTRA, FORENZA.	2004/2010	*
2.0L	CA-117-G	ASTRA, OPTRA.	2004/2008	1
2.0L	CA-133-ML	TRACKER, VITARA (CABEZA DE MLS).	1999/2003	*
2.0L	CA-215-G	SPORTAGE.	1995/2002	*

* Escanear código QR para consultar en catálogo electrónico o diríjase a catalogo.dcp.com.mx.

LITROS	Numero DC	MODELO	AÑO	PÁGINA
LITERS	DC Number	MODEL	YEAR	PAGE
2.0L	CA-235-1G	COLT, VISTA, GALANT, 2000GTX, STELLAR.	1984/1990	1
2.0L	CA-235-G	COLT, VISTA, GALANT, 2000GTX, STELLAR.	1984/1990	1
2.0L	CA-242-G	NEON, SEBRING.	1995/1999	*
2.0L	CA-242-ML	NEON, STRATUS ,BREEZE.	1996/2000	*
2.0L	CA-242-1ML	NEON.	1996/1999	1
2.0L	CA-303-1G	ESCORT, TRACER, FOCUS.	1981/2004	1
2.0L	CA-303-1ML	FOCUS.	2000/2004	*
2.0L	CA-304-G	MAZDA B2000, COURIER.	1970/1984	1
2.0L	CA-306-G	RANGER.	1983/1986	1
2.0L	CA-313-ML	CONTOUR, MYSTIQUE, ESCORT,	1995/1999	*
2.0L	CA-313-G	CONTOUR, ESCORT, FOCUS, ZX2.	1995/1997	1
2.0L	CA-348-ML	ECOSPORT, MEXICO.	2005/2009	*
2.0L	CA-348-G	ECOSPORT, FOCUS.	2001/2010	1
2.0L	CA-1110-G	PICK UP B2000, 626.	1983/1987	1
2.0L	CA-1112-ML	626 , PROTEGE, PROBE, MX-6.	1993/1997	1
2.0L	CA-1214-G	200SX, STANZA.	1982/1988	*
2.0L	CA-1218-G	200SX, PICK UP 720, 710, 620, 510.	1977/1980	1
2.0L	CA-1222-G	200SX, PICK UP, 510.	1980/1981	1
2.0L	CA-1228-G	200SX, LUCINO, SENTRA, TSURU 2000 GSR.	1992/2000	1
2.0L	CA-1238-ML	SENTRA.	2007/2011	*
2.0L	CA-1321-G	CELICA, CAMRY.	1983/1986	*
2.0L	CA-1323-G	VAN CARGA.	1984/1985	*
2.0L	CA-1324-G	CAMRY, CELICA, MR2.	1987/1995	1
2.0L	CA-1322-G	CAMRY, CELICA, MR2.	1987/1995	1
2.0L	CA-1325-ML	RAV4.	2001/2003	1
2.0L	CA-1453-G	ACCORD, PRELUDE.	1985/1989	*
2.0L	CA-1461-ML	CR-V.	1997/2001	*
2.0L	CA-1845-ML	JETTA A3, GOLF, CABRIO (CABEZA EN MLS).	1993/1999	*
2.0L	CA-1845-G	JETTA A3, GOLF, CABRIO.	1993/1999	1
2.0L	CA-1850-G	JETTA A4, GOLF, BEETLE, IBIZA (CABEZA EN GRAFITO).	2000/2007	1
2.0L	CA-1850-ML1	JETTA A4, GOLF, BEETLE, IBIZA (CABEZA EN MLS).	2000/2007	1
2.0L	CA-1850-ML	JETTA A4, GOLF, BEETLE, IBIZA (CABEZA EN MLS).	2000/2007	1
2.0L	CA-1855-ML	PASSAT, JETTA GLI.	2010/2013	*
2.0L	CA-1855-1ML	PASSAT, JETTA GLI.	2010/2013	*
2.2L	CA-108-G	CAVALIER USA, PICK-UP S10, BLAZER, BERETTA, CORSICA.	1990/1991	1
2.2L	CA-112-G	S-10, BLAZER, SONOMA, ISUZU HOMBRE.	1994/1997	1
2.2L	CA-113-G	ASTRA, ZAFIRA, SUNFIRE, CAVALIER, HHR (CABEZA DE GRAFITO).	2001/2008	1
2.2L	CA-113-ML	ASTRA, ZAFIRA, SUNFIRE, CAVALIER, HHR (CABEZA DE MLS).	2001/2008	*
2.2L	CA-240-G	VOYAGER, DART K, SHADOW, SPIRIT, DAYTONA, LeBARON.	1981/1988	1
2.2L	CA-321-ML	TRANSIT VAN.	2008/2012	*
2.2L	CA-1120-G	626, MX-6, FORD PROBE.	1988/1992	1
2.2L	CA-1310-G	CELICA, CORONA PICK-UP.	1975/1980	1
2.2L	CA-1322-ML	MR2 TURBO.	1991	*
2.2L	CA-1322-G	CAMRY, CELICA, MR2.	1987/1995	1
2.2L	CA-1324-G	CAMRY, CELICA, MR2.	1987/1995	1
2.2L	CA-1457-ML	ACCORD.	1990/1991	1
2.2L	CA-1457-G	ACCORD, PRELUDE.	1990/1997	*
2.3L	CA-109-G	PONTIAC SUNFIRE, CUTLASS, BERETTA, GRAND AM, GRAND PRIX,	1987/1991	1

LITROS LITERS	Numero DC DC Number	MODELO MODEL	AÑO YEAR	PÁGINA PAGE
		CALAIS, SKYLARK.		
2.3L	CA-300-G	TEMPO, TOPAZ.	1984/1994	1
2.3L	CA-305-G	RANGER.	1974/2002	1
2.3L	CA-346-ML	FUSION, MILAN, MAZDA 3.	2006/2009	*
2.3L	CA-1463-ML	ACCORD, ODYSSEY, ACURA CL.	1998/2002	*
2.3L	CA-1473-ML	PRELUDE.	1992/1996	*
2.3L	CA-1710-G	AMIGO, TROOPER, IMPULSE, PICK UP.	1986/1995	1
2.4L	CA-109-1G	PONTIAC SUNFIRE, GRAND AM, CAVALIER.	1997/2002	1
2.4L	CA-109-2G	ALERO ,CAVALIER, MALIBU, PONTIAC GRAND AM, SUNFIRE.	1999/2002	*
2.4L	CA-117-ML	PONTIAC G4, ASTRA.	2004/2006	*
2.4L	CA-202-G	H-100.	2003/2005	1
2.4L	CA-226-G	PATRIOT, JOURNEY, COMPASS, CALIBER, AVENGER (CABEZA EN GRAFITO).	2007/2013	1
2.4L	CA-226-ML	PATRIOT, JOURNEY, COMPASS, CALIBER, AVENGER (CABEZA EN MLS).	2007/2013	1
2.4L	CA-243-ML	PT CRUISER.	2001	*
2.4L	CA-245-G	STRATUS, CIRRUS, VOYAGER, SEBRING.	1995/2000	1
2.4L	CA-245-1ML	PT CRUISER (CABEZA EN MLS).	2002/2007	1
2.4L	CA-245-1G	PT CRUISER (CABEZA EN GRAFITO).	2002/2007	1
2.4L	CA-247-ML	ECLIPSE, GALANT, OUTLANDER, LANCER.	2005/2009	1
2.4L	CA-248-ML	OPTIMA, SANTA FE, MAGENTIS.	2001/2006	*
2.4L	CA-251-ML	ECLIPSE, GALANT, SEBRING.	2001/2005	*
2.4L	CA-251-1G	ECLIPSE, GALANT.	1993/1996	*
2.4L	CA-320-G	FALCON, MAVERICK, CUSTOM ECONOLINE.	1960/1983	*
2.4L	CA-1224-G	CAMIONETAS VAN, PICK-UP 720, D21.	1983/1989	1
2.4L	CA-1225-G	ICHI VAN, PICK-UP D21, ESTAQUITAS.	1989/1993	1
2.4L	CA-1232-G	FRONTIER, PICK UP, URVAN.	2000/2006	1
2.4L	CA-1233-G	SOLO AUTOS ALTIMA.	1993/1999	1
2.4L	CA-1327-G	PREVIA.	1991/1997	*
2.4L	CA-1328-ML	RAV4, CAMRY, HIGHLANDER.	2002/2007	*
2.4L	CA-1330-G	TACOMA.	1994/2004	*
2.4L	CA-1466-ML	CR-V.	2002/2006	*
2.4L	CA-1469-ML	CR-V, ACCORD, ELEMENT, ACURA TSX.	2004/2010	*
2.5L	CA-105-G	PONTIAC SPIRIT USA, AMX MEXICO, CAMARO, CELEBRITY, CITATION, CJ5, CJ7.	1979/1983	*
2.5L	CA-106-G	CENTURY, SKYLARK , GRAND AM.	1985/1986	*
2.5L	CA-206-D	H-100.	2005/2009	1
2.5L	CA-240-G	VOYAGER, DART K, SHADOW, SPIRIT, DAYTONA, LeBARON.	1981/1988	1
2.5L	CA-252-ML	STRATUS, CIRRUS, SEBRING (CABEZAS DE MLS).	1995/2000	*
2.5L	CA-252-G	STRATUS, CIRRUS, SEBRING (CABEZAS DE GRAFITO).	1995/2000	1
2.5L	CA-311-ML	CONTOUR, MYSTIQUE, MAZDA MPV.	1995/2000	1
2.5L	CA-312-ML	CONTOUR, MYSTIQUE.	1995/2000	1
2.5L	CA-319-ML	PROBE, 626, MILLENIA.	1993/1997	*
2.5L	CA-319-ML1	PROBE, 626, MILLENIA.	1993/1997	*
2.5L	CA-328-1ML	COUGAR, MAZDA MPV.	2001/2002	*
2.5L	CA-328-ML	COUGAR, MAZDA MPV.	2001/2002	*
2.5L	CA-703-G	EAGLE, WAGONEER, CHEROKEE, WRANGLER.	1983/1984	1
2.5L	CA-1235-G	X-TRAIL, ALTIMA, SENTRA (CABEZA DE GRAFITO).	2002/2006	1
2.5L	CA-1235-ML	X-TRAIL, ALTIMA, SENTRA (CABEZA DE MLS).	2002/2006	1

* Escanear código QR para consultar en catálogo electrónico o dirígase a catalogo.dcp.com.mx.

LITROS	Numero DC	MODELO	AÑO	PÁGINA
LITERS	DC Number	MODEL	YEAR	PAGE
2.5L	CA-1245-G	ALTIMA, SENTRA, URVAN, FRONTIER, ROGUE (CABEZA DE GRAFITO).	2007/2009	*
2.5L	CA-1245-ML	ALTIMA, SENTRA, URVAN, FRONTIER, ROGUE (CABEZA DE MLS).	2007/2009	*
2.5L	CA-1255-ML	URVAN, FRONTIER, EQUATOR (CABEZA DE MLS).	2005/2012	*
2.5L	CA-1255-G	URVAN, FRONTIER, EQUATOR (CABEZA DE GRAFITO).	2005/2012	*
2.5L	CA-1632-ML	VOLVO C30, C70, S40, V50.	2001/2011	1
2.5L	CA-1856-ML	BORA, BEETLE.	2005/2010	1
2.5L	CA-1870-ML	EUROVAN, TRANSPORTER.	2001/2004	*
2.6L	CA-250-G	CARAVAN, VOYAGER, LeBARON, RAM 50.	1981/1989	1
2.6L	CA-1125-G	PICK-UP B2600 , MPV.	1989/1994	1
2.6L	CA-1720-G	RODEO, TROOPER, AMIGO.	1988/1997	1
2.7L	CA-123-G	VITARA, GRAND VITARA.	2006/2010	*
2.7L	CA-123-1G	VITARA, GRAND VITARA.	2006/2010	*
2.7L	CA-280-G	INTREPID, CONCORDE, CIRRUS, SEBRING.	1998/2010	*
2.7L	CA-280-ML	INTREPID, CONCORDE.	1998/2000	1
2.7L	CA-281-ML	INTREPID, CONCORDE.	1998/2000	1
2.7L	CA-1352-G	TACOMA, T-100, 4RUNNER.	1994/2004	*
2.7L	CA-1354-ML	HIACE, HILUX, VENZA,	2005/2010	1
2.7L	CA-1465-G	ACCORD.	1995/1997	*
2.8L	CA-140-G	CITATION, CELEBRITY, CENTURY, CAMARO, JEEP, EAGLE (USA), PONTIAC FIERO,CAMION.	1980/1995	*
2.8L	CA-141-G	MPFI 2a GENERACION, CAVALIER, CUTLASS, EUROSPOOT, CENTURY.	1988/1994	1
2.8L	CA-315-G	AEROSTAR, BRONCO II, RANGER.	1974/1986	1
2.8L	CA-316-G	BRONCO II, RANGER.	1974/1986	*
2.8L	CA-320-G	FALCON, MAVERICK, CUSTOM ECONOLINE,	1960/1972	*
2.8L	CA-1853-ML	PASSAT, AUDI A4, A6,	1997/2001	*
2.8L	CA-1854-G	JETTA VR6, TRANSPORTER, SHARAN, GOLF GTI,	1992/2003	*
2.9L	CA-127-ML	COLORADO PICK-UP.	2007/2009	*
2.9L	CA-308-G	RANGER, BRONCO II, SCORPIO	1986/1992	1
2.9L	CA-309-G	EXPLORER, RANGER.	1986/1992	*
3.0L	CA-253-G	CARAVAN, VOYAGER, LeBARON, DYNASTY.	1987/1995	1
3.0L	CA-318-G	RANGER, AEROSTAR, TAURUS.	1986/1990	1
3.0L	CA-322-G	AEROSTAR, B3000.	1986/1990	1
3.0L	CA-323-G	AEROSTAR, B3000.	1986/1995	*
3.0L	CA-326-G	TAURUS , SABLE.	1999/2004	1
3.0L	CA-326-ML	TAURUS.	2001/2004	1
3.0L	CA-327-G	ESCAPE, TAURUS, SABLE.	2001/2004	*
3.0L	CA-327-ML	TAURUS, TRIBUTE, SABLE.	1999/2004	*
3.0L	CA-1130-ML	929, MPV.	1989/1998	1
3.0L	CA-1229-G	FRONTIER, QUEST, X TERRA, MERCURY VILLAGER.	1986/1999	1
3.0L	CA-1237-1ML	MAXIMA, INFINITI I30.	2000/2001	*
3.0L	CA-1240-ML	URVAN.	2001/2009	1
3.0L	CA-1243-ML	URVAN TURBODIESEL.	2001/2009	*
3.0L	CA-1244-ML	MAXIMA, INFINITI I30.	1995/1999	*
3.0L	CA-1350-G	4RUNNER , PICK-UP , T100.	1988/1995	1
3.0L	CA-1351-G	4RUNNER , PICK-UP , T100.	1988/1995	1
3.0L	CA-1353-G	SUPRA, LEXUS SC300, IS300, GS300.	1993/1998	*
3.0L	CA-1355-G	CAMRY, LEXUS ES300.	1992/1993	*
3.0L	CA-1356-G	CAMRY, AVALON, SIENNA, SOLARA.	1994/2000	*

LITROS	Numero DC	MODELO	AÑO	PÁGINA
LITERS	DC Number	MODEL	YEAR	PAGE
3.0L	CA-1467-ML	ACCORD , ACURA CL.	1997/2002	*
3.1L	CA-141-G	CAVALIER, GRAND AM, CUTLASS.	1988/2001	1
3.1L	CA-145-G	CUTLASS, BERETTA, MONTE CARLO, LUMINA.	1993/2007	*
3.2L	CA-225-G	AUTOS Y CAMIONES.	1960/1991	*
3.2L	CA-266-ML	INTREPID, CONCORDE.	1998/2001	*
3.2L	CA-710-G	EAGLE, RAMBLER AMERICAN, PACER, AMBASSADOR, JAVELIN.	1965/1983	1
3.2L	CA-1470-G	ACURA LEGEND, TL.	1991/1998	*
3.2L	CA-1471-ML	ACURA CL, TL.	1999/2003	*
3.2L	CA-1471-1ML	ACURA TL.	2004/2008	*
3.2L	CA-1750-G	RODEO, TROOPER , HONDA PASSPORT.	1992/1995	1
3.2L	CA-1752-ML	RODEO, AMIGO, TROOPER, AXIOM, VehiCROSS, HONDA PASSPORT.	1998/2003	*
3.2L	CA-1752-1ML	RODEO, AMIGO, TROOPER, AXIOM, VehiCROSS, HONDA PASSPORT.	1998/2003	*
3.3L	CA-146-G	PONTIAC GRAND AM, BUICK CENTURY, OLDSMOBILE CUTLAS CIERA, PONTIAC BONNEVILLE, BUICK LESABRE, REGAL, RIVERA, CHEVROLET LUMINA APV.	1990/1991	*
3.3L	CA-254-G	GRAND CARAVAN, GRAND VOYAGER.	1990/2000	1
3.3L	CA-263-ML	TOWN & COUNTRY, CARAVAN, VOYAGER.	2001/2010	*
3.3L	CA-263-ML	GRAND CARAVAN, VOYAGER.	2001/2009	*
3.3L	CA-264-ML	TOWN & COUNTRY, CARAVAN, VOYAGER.	2001/2010	*
3.3L	CA-264-ML	GRAND CARAVAN, VOYAGER.	2001/2009	*
3.3L	CA-255-ML	TOWN & COUNTRY, CARAVAN, VOYAGER.	2001/2010	*
3.3L	CA-255-ML	GRAND CARAVAN, VOYAGER.	2001/2009	*
3.3L	CA-254-ML	TOWN & COUNTRY, CARAVAN, VOYAGER.	2001/2010	*
3.3L	CA-254-ML	GRAND CARAVAN, VOYAGER.	2001/2009	*
3.3L	CA-1229-1G	PATHFINDER, FRONTIER, X-TERRA.	1996/2004	1
3.4L	CA-172-G	MONTE CARLO, OLDSMOBILE CUTLASS SUPREME, PONTIAC GRAND PRIX.	1991/1995	1
3.4L	CA-173-G	VENTURE, GRAND AM, IMPALA.	1996/2003	*
3.4L	CA-1357-G	TACOMA, 4RUNNER, T-100, TUNDRA.	1995/2004	1
3.5L	CA-110-S	BEL AIR, FLEETMASTER, TWO-TEN SERIES, AUTOS Y CAMIONES TODOS.	1937/1953	*
3.5L	CA-128-ML	COLORADO, CANYON, H3, i-350.	2004/2006	*
3.5L	CA-156-G	AURORA, INTRIGUE.	1999/2002	*
3.5L	CA-262-ML	CONCORDE, INTREPID (CABEZAS DE MLS).	1993/1997	*
3.5L	CA-261-ML	CONCORDE, INTREPID (CABEZAS DE MLS).	1993/1997	*
3.5L	CA-261-G	INTREPID, CONCORDE, NEW YORKER.	1993/1997	1
3.5L	CA-268-ML	JOURNEY, AVENGER, SEBRING, CHARGER, CHALLENGER.	2007/2010	1
3.5L	CA-268-1ML	JOURNEY, AVENGER, SEBRING, CHARGER, CHALLENGER.	2007/2010	1
3.5L	CA-310-G	CUSTOM, WAGON PICK-UP.	1954-1964	1
3.5L	CA-1236-ML	MAXIMA, ALTIMA, MURANO, QUEST, 350Z, INFINITI G35, I35.	2002/2008	*
3.5L	CA-1239-ML	PATHFINDER, INFINITI, QX4, FX35.	2001/2004	*
3.5L	CA-1470-G	ACURA RL.	1996/2004	*
3.5L	CA-1471-ML	ODYSSEY, PILOT, ACURA MDX.	1999/2004	*
3.5L	CA-1471-1ML	PILOT, ODYSSEY, RIDGELINE, ACURA MDX, SATURN VUE.	2003/2010	*
3.5L	CA-1476-ML	ACCORD, ACCORD CROSSTOUR, PILOT, RIDGELINE, ODYSSEY, ACURA RDX, TSX, TL.	2008/2013	*
3.5L	CA-1476-1ML	ACCORD, ACCORD CROSSTOUR, PILOT, RIDGELINE, ODYSSEY, ACURA RDX, TSX, TL.	2008/2013	*
3.5L	CA-1752-1ML	RODEO, AMIGO, TROOPER, AXIOM, VehiCROSS, HONDA PASSPORT.	1998/2003	*

* Escanear código QR para consultar en catálogo electrónico o diríjase a catalogo.dcp.com.mx.

LITROS LITERS	Numero DC DC Number	MODELO MODEL	AÑO YEAR	PÁGINA PAGE
3.5L	CA-1752-ML	RODEO, AMIGO, TROOPER, AXIOM, VehiCROSS, HONDA PASSPORT.	1998/2003	*
3.6L	CA-183-ML	ACADIA, EQUINOX, MALIBU, G6, G8, TORRENT, CADILLAC CTS, SRX Y STS.	2004/2011	*
3.6L	CA-183-1ML	EQUINOX, MALIBU, TORRENT.	2008/2010	*
3.6L	CA-269-1ML	TOWN & COUNTRY, CARAVAN, AVENGER, JOURNEY, CHALLENGER, RAM 1500, 200.	2011/2013	1
3.6L	CA-269-ML	TOWN & COUNTRY, CARAVAN, AVENGER, JOURNEY, CHALLENGER, RAM 1500, 200.	2011/2013	1
3.7L	CA-129-ML	COLORADO, CANYON, ISUZU I-370, HUMMER H3.	2007/2012	*
3.7L	CA-271-ML	DAKOTA, RAM 1500, JEEP LIBERTY (CABEZA EN MLS).	2002/2005	1
3.7L	CA-271-G	DAKOTA, RAM 1500, JEEP LIBERTY (CABEZA EN GRAFITO).	2002/2005	1
3.8L	CA-120-S	BEL AIR, AUTOS & CAMIONES.	1953/1962	*
3.8L	CA-142-G	AUTOS BUICK, CUTLASS, MONTE CARLO, MALIBU.	1977/1982	*
3.8L	CA-143-G	MALIBU, IMPALA, CAPRICE, PONTIAC LeMANS.	1980/1984	*
3.8L	CA-146-G	PONTIAC GRAND AM, BUICK CENTURY, OLDSMOBILE CUTLAS CIERA, PONTIAC BONNEVILLE, BUICK LESABRE, REGAL, RIVERA, CHEVRO- LET LUMINA APV.	1991/1993	*
3.8L	CA-147-G	ELECTRA, LE SABRE, REATTA, RIVERA.	1988/1990	*
3.8L	CA-148-G	GRAND PRIX, LeSABRE, MONTE CARLO, LUMINA, REGAL, BONNEVILLE.	1997/2005	1
3.8L	CA-149-G	BUICK LE SABRE, REGAL, RIVIERA, PONTIAC GRAND PRIX, LUMINA, MONTE CARLO, IMPALA.	1995/2005	*
3.8L	CA-149-1G	PARK AVENUE, REGAL, RIVIERA, IMPALA, GRAND PRIX (SUPERCAR- GADOS).	1997/2005	*
3.8L	CA-210-S	AUTOS Y CAMIONES.	1949/1960	*
3.8L	CA-254-1G	TOWN & COUNTRY, GRAND CARAVAN, GRAND VOYAGER (CARTER Y PUNTERIAS DE SILICON).	1998/2000	1
3.8L	CA-255-1G	TOWN & COUNTRY, GRAND CARAVAN, PACIFICA.	2002/2008	*
3.8L	CA-263-G	TOWN & COUNTRY, CARAVAN, VOYAGER (CARTER Y PUNTERIAS DE CORCHO).	1998/2001	1
3.8L	CA-330-G	FORD FAIRMONT.	1982/1983	1
3.8L	CA-332-1G	WINDSTAR.	1994/1995	1
3.8L	CA-332-G	WINDSTAR.	1994/1995	1
3.8L	CA-341-ML	MUSTANG, WINDSTAR, LOBO F-150.	1995/2003	*
3.8L	CA-341-G	WINDSTAR, ECONOLINE.	1997/1998	1
3.8L	CA-342-ML	LOBO, E-150, F-150, PICK-UP.	1998/2004	1
3.8L	CA-342-G	WINDSTAR, F-150, LOBO.	1995/2003	*
3.8L	CA-710-G	EAGLE, RAMBLER AMERICAN, PACER, AMBASSADOR, JAVELIN.	1965/1983	1
3.9L	CA-265-G	DAKOTA AMERICANAS, B150, B250	1987/1989	1
3.9L	CA-270-G	DAKOTA, RAM 1500, RAM VAN.	1992/1997	1
3.9L	CA-325-G	AUTOS Y CAMIONETAS.	1965/1986	*
4.0L	CA-139-1G	AURORA, OLDSMOBILE ;SHELBY.	1995/2003	*
4.0L	CA-139-1G	AURORA, OLDSMOBILE ;SHELBY	1995/2003	*
4.0L	CA-139-G	AURORA, OLDSMOBILE ;SHELBY.	1995/2003	*
4.0L	CA-139-G	AURORA, OLDSMOBILE ;SHELBY	1995/2003	*
4.0L	CA-335-G	EXPLORER, RANGER.	1990/1994	1
4.0L	CA-336-G	AEROSTAR, EXPLORER, RANGER.	1997/2000	*
4.0L	CA-337-ML	EXPLORER, MONTAINNER.	1997/2010	*
4.0L	CA-337-G	EXPLORER, MONTAINNER.	1997/2001	1

LITROS	Numero DC	MODELO	AÑO	PÁGINA
LITERS	DC Number	MODEL	YEAR	PAGE
4.0L	CA-338-G	EXPLORER, RANGER.	1997/2010	*
4.0L	CA-338-ML	EXPLORER, RANGER.	1997/2010	*
4.0L	CA-715-G	EAGLE, CHEROKEE, WAGONEER, COMANCHE.	1987/1990	1
4.0L	CA-1361-G	LEXUS LS400, SC400.	1990/1997	*
4.0L	CA-1361-1ML	LEXUS GS400, LS400, SC400.	1998/2000	*
4.0L	CA-1361-ML	LEXUS GS400, LS400, SC400.	1998/2000	*
4.0L	CA-1367-G	LAND CRUISER.	1988/1992	*
4.1L	CA-130-G	AUTOS Y CAMIONES.	1963/1992	1
4.1L	CA-132-G	SERIES C10, C20, C30, K10, K20.	1979	*
4.1L	CA-200-S	NEWPORT, TOWN & COUNTRY, WINDSOR	1954/1960	*
4.2L	CA-153-ML	TRAILBLAZER, ENVOY, ASCENDER, BRAVADA (CABEZA DE MLS).	2002/2006	*
4.2L	CA-153-G	TRAILBLAZER, ENVOY, ASCENDER, BRAVADA (CABEZA DE GRAFITO).	2002/2006	1
4.2L	CA-340-L	AUTOS MERCURY.	1949/1954	*
4.2L	CA-340-R	AUTOS MERCURY.	1949/1954	*
4.2L	CA-710-G	EAGLE, RAMBLER AMERICAN, PACER, AMBASSADOR, JAVELIN.	1965/1983	1
4.2L	CA-1367-G	LAND CRUISER.	1985/1987	*
4.3L	CA-144-G	ASTRO, PICKUP S-10, C10, C20, C1500, C2500, SAFARI, CAPRICE, EL CAMINO.	1985/1990	1
4.3L	CA-151-G	CAPRICE.	1994/1996	1
4.3L	CA-162-G	CUTLASS, BROGHAM, CALAIS, CRUSIER, SALON, DELTA 88, OMEGA.	1977/1982	*
4.5L	CA-260-G	VALIANT, DART, CHARGER, BARRACUDA, MONACO, CORONET.	1964/1969	*
4.6L	CA-174-G	CADILLAC DEVILLE, ELDORADO, SEVILLE, PONTIAC BONEVILLE.	2000/2001	*
4.6L	CA-356-G	C.VICTORIA, CONTINENTAL, GRAND MARQUIS.	1991/1994	1
4.6L	CA-356-1G	MUSTANG, GRAND MARQUIS.	1995/1998	1
4.6L	CA-357-ML	GRAND MARQUIS, F-150, F250, LOBO.	1991/2007	1
4.6L	CA-357-ML1	GRAND MARQUIS, F-150, F250, LOBO.	1991/2007	1
4.6L	CA-357-G	GRAND MARQUIS, F-150, F250, LOBO.	1991/2007	1
4.6L	CA-710-G	EAGLE, RAMBLER AMERICAN, PACER, WAGONEER, JAVELIN.	1965/1987	1
4.7L	CA-272-ML	RAM 1500, 2500, GRAND CHEROKEE, DURANGO, DAKOTA (CABEZA EN MLS).	1999/2005	1
4.7L	CA-272-G	RAM 1500, 2500, GRAND CHEROKEE, DURANGO, DAKOTA (CABEZA EN GRAFITO).	1999/2005	1
4.8L	CA-130-G	AUTOS Y CAMIONES.	1963/1992	1
4.8L	CA-175-G	CHEYENNE, SILVERADO 1500, 2500, SUBURBAN, YUKON, SIERRA 1500, 2500, TAHOE (CABEZAS DE GRAFITO).	1999/2001	1
4.8L	CA-175-ML	CHEYENNE, SILVERADO 1500, 2500, SUBURBAN, YUKON, SIERRA 1500, 2500, TAHOE (CABEZAS DE MLS).	1999/2001	1
5.0L	CA-160-G	AUTOS Y CAMIONES.	1976/1980	*
5.0L	CA-360-G	AUTOS Y CAMIONES.	1962/1997	*
5.2L	CA-256-G	CORONET, CHARGER, SERIES D100, D200, D300.	1959/1966	*
5.2L	CA-260-G	VALIANT, DART, CHARGER, BARRACUDA, MONACO, CORONET.	1964/1969	*
5.2L	CA-275-G	B150, B250, B350, W150, W250, RAMCHARGER, DAKOTA.	1989/1992	1
5.3L	CA-175-ML	CHEYENNE, SILVERADO 1500, 2500, SUBURBAN, YUKON, SIERRA 1500, 2500, TAHOE (CABEZAS DE MLS).	1999/2001	1
5.3L	CA-175-G	CHEYENNE, SILVERADO 1500, 2500, SUBURBAN, YUKON, SIERRA 1500, 2500, TAHOE (CABEZAS DE GRAFITO).	1999/2001	1
5.4L	CA-355-G	AUTOS Y CAMIONES.	1961/1976	1
5.4L	CA-356-ML1	F-250, F-150, LOBO, G, MARQUIS.	1991/2007	*

* Escanear código QR para consultar en catálogo electrónico o diríjase a catalogo.dcp.com.mx.

LITROS	Numero DC	MODELO	AÑO	PÁGINA
LITERS	DC Number	MODEL	YEAR	PAGE
5.4L	CA-356-ML1	F-250, F-150, LOBO , G, MARQUIS.	1991/2007	*
5.4L	CA-356-ML	F-250, F-150, LOBO, G, MARQUIS.	1991/2007	*
5.4L	CA-356-ML	F-250, F-150, LOBO , G, MARQUIS.	1991/2007	*
5.4L	CA-357-G	F-150, F250, LOBO.	1991/2009	1
5.4L	CA-357-1G	EXPEDITION , LOBO, F-150, F-250 NAVIGATOR.	2004/2010	*
5.6L	CA-718-G	AMBASSADOR, JAVELIN, RAMBLER.	1967/1974	*
5.6L	CA-1256-G	ARMADA ,TITAN, PATHFINDER (CABEZA DE GRAFITO).	2004/2010	*
5.6L	CA-1256-1G	TITAN, ARMADA, PATHFINDER (CABEZA DE GRAFITO).	2004/2010	1
5.7L	CA-150-G	MICROBUS, SUBURBAN, C-2500, C-3500, PICK-UP SOLO MEXICO.	1992/1998	1
5.7L	CA-151-1G	FIREBIRD, CAMARO Z28, CAPRICE.	1992/1997	1
5.7L	CA-164-G	APOLLO, OMEGA, CENTURY, ELECTRA, LE SABRE, OLDSMOBILE, BUICK.	1968/1980	*
5.7L	CA-273-ML	RAM 1500, 2500, 3500, DURANGO, GRAND CHEROKEE, COMANDER	2003/2009	1
5.7L	CA-273-G	300C, CHALLENGER, CHARGER.	2005/2012	1
5.8L	CA-365-G	TRUCKS, GALAXIE, GRAND MARQUIS.	1969/1983	1
5.8L	CA-370-G	F-150, PICK-UP, TRUCKS.	1970/1982	1
5.9L	CA-249-ML	RAM 2500,3500 CUMMINS TURBO	2003/2008	*
5.9L	CA-718-G	AMBASSADOR, JAVELIN, MATADOR, CHEROKEE, WAGONEER, GRAND WAGONNER.	1971/1991	1
6.0L	CA-176-G	SILVERADO 2500, SIERRA 2500, YUKON, EXPRESS VAN,CARGO VAN, SUBURBAN (CABEZA DE GRAFITO).	1999/2000	1
6.0L	CA-176-ML	SILVERADO 2500, SIERRA 2500, YUKON, EXPRESS VAN,CARGO VAN, SUBURBAN (CABEZAS DE MLS).	1999/2000	1
6.1L	CA-380-G	CAMIONES.	1979/1989	1
6.2L	CA-179-G	SUBURBAN 1500, 2500, 3500, PICK UP K1500, 2500, 3500, C1500, C2500, C3500, HUMMER.	1982/1993	1
6.4L	CA-718-G	AMBASSADOR, JAVELIN, RAMBLER,	1971/1978	*
6.5L	CA-180-GD	PICK UP C1500, C2500, C3500, K1500, K2500, K3500, EXPRESS 2500, 3500, SAVANA, YUKON, TAHOE, HUMMER H1.	1994/2005	1
6.6L	CA-155-G	MONTE CARLO, IMPALA, CHEVELLE NOMAD, CAPRICE, BEL AIR, CAMARO, EL CAMINO, PONTIAC FIREBIRD, BONNEVILLE.	1970/1976	*
6.6L	CA-718-G	AMBASSADOR, JAVELIN, MATADOR, CHEROKEE, WAGONNER	1971/1983	*
6.8L	CA-390-ML	TRUCKS, F-450 SUPER DUTY, EXCURSION.	1997/2003	*
6.8L	CA-390-G	TRUCKS, F-450 SUPER DUTY.	1997/1999	1
6.8L	CA-391-ML	ECONOLINE, SUPER DUTY , F-450.	1997/2003	*
6.8L	CA-391-G	F-450,SUPER DUTY.	1999/2007	1
7.0L	CA-167-G	CAMARO, CORVETTE, CAPRICE, IMPALA.	1965/1969	*
7.0L	CA-375-G	GALAXIE, CUSTOM 500, F-350, F-600.	1968/1985	1
7.2L	CA-258-G	CHARGER, CORONET, BARRACUDA, CHALLENGER, MONACO, CORONET, FURY	1966/1978	*
7.3L	CA-376-G	F SUPER DUTY ,F-250-E250-E-350	1988/1995	*
7.3L	CA-396-1G	E-250, E-350, ECONOLINE.	1994/2003	1
7.4L	CA-167-G	AUTOS Y CAMIONES.	1970/1980	*
7.4L	CA-168-G	PICK UP C1500, C2500, C3500.	1980/1985	*
7.4L	CA-169-G	KODIAK C2500, C3500, K2500, K3500.	1996/2000	1
7.5L	CA-375-G	GALAXIE, CUSTOM 500, F-350, F-700.	1968/1985	1
8.0L	CA-282-G	RAM 2500, 3500, VIPER.	1992/2003	1
8.1L	CA-181-G	SILVERADO, 2500HD, 3500, SIERRA 2500, 3500, YUKON, SUBURBAN, AVALANCHE, EXPRESS VAN.	2001/2007	1



2.5L		MOTOR	MODELOS	DESDE / A	
		ENGINE	MODELS	FROM / TO	
CA-703-G	4L OHV 8V 3L SOHC 6V 61" SA310 4L AMC OHV 8V VIN U,C	4L OHV 8V 3L SOHC 6V 61" SA310 4L AMC OHV 8V VIN U,C	EAGLE, WAGONEER, CHEROKEE, WRANGLER.	1983/1984	
3.2L		MOTOR	MODELOS	DESDE / A	
		ENGINE	MODELS	FROM / TO	
CA-710-G	3L SOHC 6v 61" L6 OHV 12V 199"	3L SOHC 6v 61" L6 OHV 12V 199"	EAGLE, RAMBLER AMERICAN, PACER, AMBASSADOR, JAVELIN.	1965/1983	
3.8L		MOTOR	MODELOS	DESDE / A	
		ENGINE	MODELS	FROM / TO	
CA-710-G	L6 OHV 12V 232"	L6 OHV 12V 232"	EAGLE, RAMBLER AMERICAN, PACER, AMBASSADOR, JAVELIN.	1965/1983	
4.0L		MOTOR	MODELOS	DESDE / A	
		ENGINE	MODELS	FROM / TO	
CA-715-G	L6 AMC OHV 12V 242"	L6 AMC OHV 12V 242"	EAGLE, CHEROKEE, WAGONEER, COMANCHE.	1987/1990	
4.2L		MOTOR	MODELOS	DESDE / A	
		ENGINE	MODELS	FROM / TO	
CA-710-G	L6 OHV 12V 258"	L6 OHV 12V 258"	EAGLE, RAMBLER AMERICAN, PACER, AMBASSADOR, JAVELIN.	1965/1983	
4.2L		MOTOR	MODELOS	DESDE / A	
		ENGINE	MODELS	FROM / TO	
CA-710-G	L6 OHV 12V 258"	L6 OHV 12V 258"	EAGLE, RAMBLER AMERICAN, PACER, AMBASSADOR, JAVELIN.	1965/1983	
4.6L		MOTOR	MODELOS	DESDE / A	
		ENGINE	MODELS	FROM / TO	
CA-710-G	L6 OHV 12V 282"	L6 OHV 12V 282"	EAGLE, RAMBLER AMERICAN, PACER, WAGONEER, JAVELIN.	1965/1987	



1.0L		MOTOR	MODELOS	DESDE / A	
		ENGINE	MODELS	FROM / TO	
CA-201-G		4L SOHC.12 V G4HC	ATOS.	2000/2003	
1.1L		MOTOR	MODELOS	DESDE / A	
		ENGINE	MODELS	FROM / TO	
CA-201-1G		4L SOHC 12 V G4HC	ATOS.	2004/2009	
1.4L		MOTOR	MODELOS	DESDE / A	
		ENGINE	MODELS	FROM / TO	
CA-204-ML		4L, DOHC 16V G4EE G4KF	ATTITUDE.	2006/2011	
1.4L		MOTOR	MODELOS	DESDE / A	
		ENGINE	MODELS	FROM / TO	
CA-230-G		4L, SOHC 8V MOTOR MITSUBISHI G15B	COLT, MIRAGE, EXCEL.	1979/1991	
1.5L		MOTOR	MODELOS	DESDE / A	
		ENGINE	MODELS	FROM / TO	
CA-203-ML		4L, SOHC 12V G4EK	VERNA.	2000/2006	
1.5L		MOTOR	MODELOS	DESDE / A	
		ENGINE	MODELS	FROM / TO	
CA-230-G		4L, SOHC 8V MOTOR MITSUBISHI G15B	COLT, MIRAGE, EXCEL.	1979/1984	
1.8L		MOTOR	MODELOS	DESDE / A	
		ENGINE	MODELS	FROM / TO	
CA-205-G		4L SOHC 4G93	EXPO, COLT, MIRAGE	1993/1996	
1.8L		MOTOR	MODELOS	DESDE / A	
		ENGINE	MODELS	FROM / TO	
CA-237-G		4L, SOHC 8V MOTOR MITSUBISHI 4G37 VIN T	ECLIPSE, TALON, COLT, LASER.	1989/1994	



2.0L	MOTOR	MODELOS	DESDE / A	
	ENGINE	MODELS	FROM / TO	
CA-235-1G	4L, SOHC 8V MOTOR MITSUBISHI G63B 4G63 VIN V	COLT, VISTA, GALANT, 2000GTX, STELLAR.	1984/1990	
2.0L	MOTOR	MODELOS	DESDE / A	
	ENGINE	MODELS	FROM / TO	
CA-235-G	4L, SOHC 8V MOTOR MITSUBISHI G63B 4G63 VIN V	COLT, VISTA, GALANT, 2000GTX, STELLAR.	1984/1990	
2.0L	MOTOR	MODELOS	DESDE / A	
	ENGINE	MODELS	FROM / TO	
CA-242-G	4L, DOHC 16V VIN C, Y	NEON, SEBRING.	1995/1999	
2.0L	MOTOR	MODELOS	DESDE / A	
	ENGINE	MODELS	FROM / TO	
CA-242-ML	4L SOHC 16V	NEON, STRATUS ,BREEZE.	1996/2000	
2.0L	MOTOR	MODELOS	DESDE / A	
	ENGINE	MODELS	FROM / TO	
CA-242-1ML	4L, SOHC 16V VIN C	NEON.	1996/1999	
2.2L	MOTOR	MODELOS	DESDE / A	
	ENGINE	MODELS	FROM / TO	
CA-240-G	4L, SOHC 8V VIN K C D EXCEPTO TURBO	VOYAGER, DART K, SHADOW, SPIRIT, DAYTONA, LeBARON.	1981/1988	
2.4L	MOTOR	MODELOS	DESDE / A	
	ENGINE	MODELS	FROM / TO	
CA-202-G	4L, SOHC 8V G64B 464B	H-100.	2003/2005	
2.4L	MOTOR	MODELOS	DESDE / A	
	ENGINE	MODELS	FROM / TO	
CA-226-G	4L, DOHC 16V MOTOR GEMA VIN W, B	PATRIOT, JOURNEY, COMPASS, CALIBER, AVENGER (CABEZA EN GRAFITO).	2007/2013	









2.4L	MOTOR	MODELOS	DESDE / A	
	ENGINE	MODELS	FROM / TO	
CA-226-ML	4L, DOHC 16V MOTOR GEMA VIN W, B	PATRIOT, JOURNEY, COMPASS, CALIBER, AVENGER (CABEZA EN MLS).	2007/2013	
2.4L	MOTOR	MODELOS	DESDE / A	
	ENGINE	MODELS	FROM / TO	
CA-243-ML	4L, DOHC 16V VIN B	PT CRUISER.	2001	
2.4L	MOTOR	MODELOS	DESDE / A	
	ENGINE	MODELS	FROM / TO	
CA-245-G	4L, DOHC 16V VIN X, B	STRATUS, CIRRUS, VOYAGER, SEBRING.	1995/2000	
2.4L	MOTOR	MODELOS	DESDE / A	
	ENGINE	MODELS	FROM / TO	
CA-245-1ML	4L, DOHC 16V VIN X, B	PT CRUISER (CABEZA EN MLS).	2002/2007	
2.4L	MOTOR	MODELOS	DESDE / A	
	ENGINE	MODELS	FROM / TO	
CA-245-1G	4L, DOHC 16V VIN X, B	PT CRUISER (CABEZA EN GRAFITO).	2002/2007	
2.4L	MOTOR	MODELOS	DESDE / A	
	ENGINE	MODELS	FROM / TO	
CA-251-ML	4L, SOHC 16V MOTOR 4G64	ECLIPSE, GALANT, SEBRING.	2001/2005	
2.4L	MOTOR	MODELOS	DESDE / A	
	ENGINE	MODELS	FROM / TO	
CA-251-1G	4L SOHC 16V "4G64"	ECLIPSE, GALANT.	1993/1996	
2.5L	MOTOR	MODELOS	DESDE / A	
	ENGINE	MODELS	FROM / TO	
CA-206-D	4L, SOHC 8V TDI MOTOR MITSUBISHI 4D56T	H-100.	2005/2009	

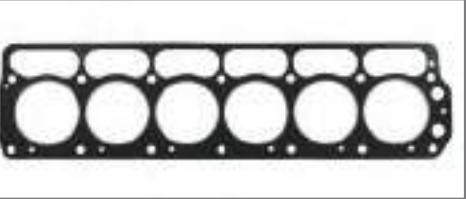

2.5L	MOTOR	MODELOS	DESDE / A	
	ENGINE	MODELS	FROM / TO	
CA-240-G	4L, SOHC 8V VIN K C D EXCEPTO TURBO	VOYAGER, DART K, SHADOW, SPIRIT, DAYTONA, LeBARON.	1981/1988	
2.5L	MOTOR	MODELOS	DESDE / A	
	ENGINE	MODELS	FROM / TO	
CA-252-ML	V6, SOHC 24V	STRATUS, CIRRUS, SEBRING (CABEZAS DE MLS).	1995/2000	
2.5L	MOTOR	MODELOS	DESDE / A	
	ENGINE	MODELS	FROM / TO	
CA-252-G	V6, SOHC 24V MOTOR MITSUBISHI 6G73 VIN H	STRATUS, CIRRUS, SEBRING (CABEZAS DE GRAFITO).	1995/2000	
2.6L	MOTOR	MODELOS	DESDE / A	
	ENGINE	MODELS	FROM / TO	
CA-250-G	4L, SOHC 8V MOTOR G54B VIN G, E	CARAVAN, VOYAGER, LeBARON, RAM 50.	1981/1989	
2.7L	MOTOR	MODELOS	DESDE / A	
	ENGINE	MODELS	FROM / TO	
CA-280-G	V6, SOHC 24V	INTREPID, CONCORDE, CIRRUS, SEBRING. (IZQUIERDA)	1998/2010	
2.7L	MOTOR	MODELOS	DESDE / A	
	ENGINE	MODELS	FROM / TO	
CA-281-G	V6, SOHC 24V	INTREPID, CONCORDE, CIRRUS, SEBRING. (DERECHA)	1998/2010	
2.7L	MOTOR	MODELOS	DESDE / A	
	ENGINE	MODELS	FROM / TO	
CA-280-ML	V6, DOHC 24V VIN R	INTREPID, CONCORDE. (IZQUIERDA)	1998/2000	
2.7L	MOTOR	MODELOS	DESDE / A	
	ENGINE	MODELS	FROM / TO	
CA-281-ML	V6, DOHC 24V VIN R	INTREPID, CONCORDE. (DERECHA)	1998/2000	







3.0L	MOTOR	MODELOS	DESDE / A	
	ENGINE	MODELS	FROM / TO	
CA-253-G	V6, SOHC 12V MOTOR MITSUBISHI 6G72 MULT. ESCAPE S/ DEFLECTOR	CARAVAN, VOYAGER, LeBARON, DYNASTY.	1987/1995	
3.2L	MOTOR	MODELOS	DESDE / A	
	ENGINE	MODELS	FROM / TO	
CA-225-G	6L OHV VIN "A"	AUTOS Y CAMIONES.	1960/1991	
3.2L	MOTOR	MODELOS	DESDE / A	
	ENGINE	MODELS	FROM / TO	
CA-266-ML	V6 SOHC 24V	INTREPID, CONCORDE. (IZQUIERDA)	1998/2001	
3.2L	MOTOR	MODELOS	DESDE / A	
	ENGINE	MODELS	FROM / TO	
CA-266-1ML	V6 SOHC 24V	INTREPID, CONCORDE. (DERECHA)	1998/2001	
3.3L	MOTOR	MODELOS	DESDE / A	
	ENGINE	MODELS	FROM / TO	
CA-254-G	V6, OHV 12V NO INCLUYE CONCHA DE ADMISION. (IZQUIERDA)	GRAND CARAVAN, GRAND VOYAGER. (IZQUIERDA)	1990/2000	
3.3L	MOTOR	MODELOS	DESDE / A	
	ENGINE	MODELS	FROM / TO	
CA-255-G	V6, OHV 12V NO INCLUYE CONCHA DE ADMISION. (DERECHA)	GRAND CARAVAN, GRAND VOYAGER. (DERECHA)	1990/2000	
3.3L	MOTOR	MODELOS	DESDE / A	
	ENGINE	MODELS	FROM / TO	
CA-255-ML	V6, OHV 12V VIN R, 3, H, E	TOWN & COUNTRY, CARAVAN, VOYAGER. (DERECHA)	2001/2010	
3.3L	MOTOR	MODELOS	DESDE / A	
	ENGINE	MODELS	FROM / TO	
CA-254-ML	V6, OHV 12V VIN R, 3, H, E	TOWN & COUNTRY, CARAVAN, VOYAGER. (IZQUIERDA)	2001/2010	

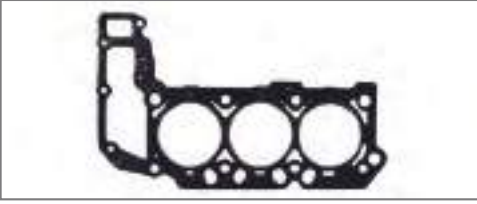
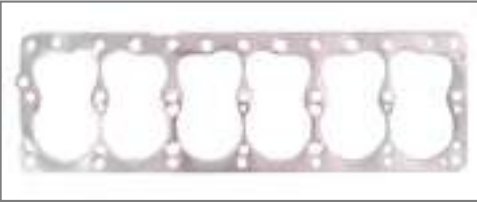
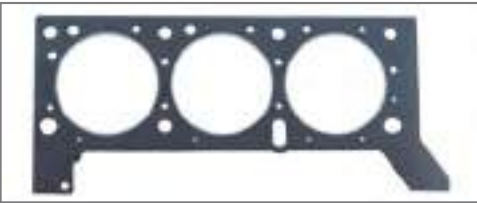
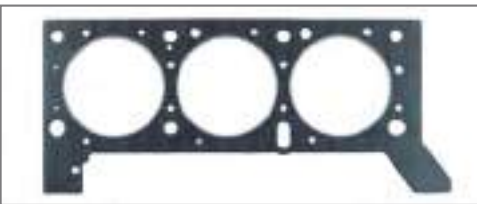

3.5L	MOTOR	MODELOS	DESDE / A	
	ENGINE	MODELS	FROM / TO	
CA-262-ML	V6 SOHC 24V VIN "F,G"	CONCORDE, INTREPID (CABEZAS DE MLS). (DERECHA)	1993/1997	
3.5L	MOTOR	MODELOS	DESDE / A	
	ENGINE	MODELS	FROM / TO	
CA-261-ML	V6 SOHC 24V VIN "F,G"	CONCORDE, INTREPID (CABEZAS DE MLS). (IZQUIERDA)	1993/1997	
3.5L	MOTOR	MODELOS	DESDE / A	
	ENGINE	MODELS	FROM / TO	
CA-261-G	V6, SOHC 24V VIN F	INTREPID, CONCORDE, NEW YORKER. (IZQUIERDA)	1993/1997	
3.5L	MOTOR	MODELOS	DESDE / A	
	ENGINE	MODELS	FROM / TO	
CA-262-G	V6, SOHC 24V VIN F	INTREPID, CONCORDE, NEW YORKER. (DERECHA)	1993/1997	
3.5L	MOTOR	MODELOS	DESDE / A	
	ENGINE	MODELS	FROM / TO	
CA-268-ML	V6, SOHC 24V	JOURNEY, AVENGER, SEBRING, CHARGER, CHALLENGER. (IZQUIERDA)	2007/2010	
3.5L	MOTOR	MODELOS	DESDE / A	
	ENGINE	MODELS	FROM / TO	
CA-268-1ML	V6, SOHC 24V	JOURNEY, AVENGER, SEBRING, CHARGER, CHALLENGER. (DERECHA)	2007/2010	
3.6L	MOTOR	MODELOS	DESDE / A	
	ENGINE	MODELS	FROM / TO	
CA-269-1ML	V6, DOHC 24V MOTOR PENTASTAR VIN G	TOWN & COUNTRY, CARAVAN, AVENGER, JOURNEY, CHALLENGER, RAM 1500, 200. (IZQUIERDA)	2011/2013	
3.6L	MOTOR	MODELOS	DESDE / A	
	ENGINE	MODELS	FROM / TO	
CA-269-ML	V6, DOHC 24V MOTOR PENTASTAR VIN G	TOWN & COUNTRY, CARAVAN, AVENGER, JOURNEY, CHALLENGER, RAM 1500, 200. (DERECHA)	2011/2013	



3.7L	MOTOR	MODELOS	DESDE / A	
	ENGINE	MODELS	FROM / TO	
CA-271-ML	V6, SOHC 12V VIN K CABEZA DE MLS	DAKOTA, RAM 1500, JEEP LIBERTY (CABEZA EN MLS).	2002/2005	
3.7L	MOTOR	MODELOS	DESDE / A	
	ENGINE	MODELS	FROM / TO	
CA-271-G	V6, SOHC 12V VIN K CABEZA DE GRAFITO	DAKOTA, RAM 1500, JEEP LIBERTY (CABEZA EN GRAFITO).	2002/2005	
3.8L	MOTOR	MODELOS	DESDE / A	
	ENGINE	MODELS	FROM / TO	
CA-210-S	6L 218",230" ENGINES	AUTOS Y CAMIONES.	1949/1960	
3.8L	MOTOR	MODELOS	DESDE / A	
	ENGINE	MODELS	FROM / TO	
CA-254-1G	V6, OHV 12V VIN P, L NO INCLUYE VALLE DE ADMISION	TOWN & COUNTRY, GRAND CARAVAN, GRAND VOYAGER (CARTER Y PUNTERIAS DE SILICON). (IZQUIERDA)	1998/2000	
3.8L	MOTOR	MODELOS	DESDE / A	
	ENGINE	MODELS	FROM / TO	
CA-255-1G	V6 OHV 12V VIN L, P	TOWN & COUNTRY, GRAND CARAVAN, PACIFICA. (DERECHA)	2002/2008	
3.8L	MOTOR	MODELOS	DESDE / A	
	ENGINE	MODELS	FROM / TO	
CA-263-G	V6, OHV 12V VIN L NO INCLUYE ADMISION	TOWN & COUNTRY, CARAVAN, VOYAGER (CARTER Y PUNTERIAS DE CORCHO). (DERECHA).	1998/2001	
3.8L	MOTOR	MODELOS	DESDE / A	
	ENGINE	MODELS	FROM / TO	
CA-263-ML	V6, OHV 12V VIN R, 3, H, E	TOWN & COUNTRY, CARAVAN, VOYAGER.	2001/2010	
3.8L	MOTOR	MODELOS	DESDE / A	
	ENGINE	MODELS	FROM / TO	
CA-264-G	V6, OHV 12V VIN L NO INCLUYE ADMISION	TOWN & COUNTRY, CARAVAN, VOYAGER (CARTER Y PUNTERIAS DE CORCHO). (IZQUIERDA).	1998/2001	



3.8L	MOTOR	MODELOS	DESDE / A	
	ENGINE	MODELS	FROM / TO	
CA-264-ML	V6 OHV 12V VIN "R"	GRAND CARAVAN, VOYAGER.	2001/2009	
3.9L	MOTOR	MODELOS	DESDE / A	
	ENGINE	MODELS	FROM / TO	
CA-265-G	V6, OHV 12V VIN X	DAKOTA AMERICANAS, B150, B250	1987/1989	
3.9L	MOTOR	MODELOS	DESDE / A	
	ENGINE	MODELS	FROM / TO	
CA-270-G	V6, OHV 12V VIN X MOTOR MAGNUM	DAKOTA, RAM 1500, RAM VAN.	1992/1997	
4.1L	MOTOR	MODELOS	DESDE / A	
	ENGINE	MODELS	FROM / TO	
CA-200-S	L6, OHV MOTOR "251"	NEWPORT, TOWN & COUNTRY, WINDSOR	1954/1960	
4.5L	MOTOR	MODELOS	DESDE / A	
	ENGINE	MODELS	FROM / TO	
CA-260-G	V8, OHV 16V	VALIANT, DART, CHARGER, BARRACUDA, MONACO, CORONET.	1964/1969	
4.7L	MOTOR	MODELOS	DESDE / A	
	ENGINE	MODELS	FROM / TO	
CA-272-ML	V8, SOHC 16V VIN J, P, N MOTOR POWER TECH CABEZA DE MLS	RAM 1500, 2500, GRAND CHEROKEE, DURANGO, DAKOTA (CABEZA EN MLS).	1999/2005	
4.7L	MOTOR	MODELOS	DESDE / A	
	ENGINE	MODELS	FROM / TO	
CA-272-G	V8, SOHC 16V VIN J, P, N MOTOR POWER TECH CABEZA DE GRAFITO	RAM 1500, 2500, GRAND CHEROKEE, DURANGO, DAKOTA (CABEZA EN GRAFITO).	1999/2005	
5.2L	MOTOR	MODELOS	DESDE / A	
	ENGINE	MODELS	FROM / TO	
CA-256-G	V8, OHV 16V	CORONET, CHARGER, SERIES D100, D200, D300.	1959/1966	



5.2L	MOTOR	MODELOS	DESDE / A	
	ENGINE	MODELS	FROM / TO	
CA-260-G	V8, OHV 16V	VALIANT, DART, CHARGER, BARRACUDA, MONACO, CORONET.	1964/1969	
5.2L	MOTOR	MODELOS	DESDE / A	
	ENGINE	MODELS	FROM / TO	
CA-275-G	V8, OHV 16V VIN Y	B150, B250, B350, W150, W250, RAMCHARGER, DAKOTA.	1989/1992	
5.6L	MOTOR	MODELOS	DESDE / A	
	ENGINE	MODELS	FROM / TO	
CA-718-G	V8 OHV 16V 343"	AMBASSADOR, JAVELIN, RAMBLER.	1967/1974	
5.7L	MOTOR	MODELOS	DESDE / A	
	ENGINE	MODELS	FROM / TO	
CA-273-ML	V8, OHV 16V MOTOR HEMI CABEZA DE MLS	RAM 1500, 2500, 3500, DURANGO, GRAND CHEROKEE, COMANDER. (IZQUIERDA)	2003/2009	
5.7L	MOTOR	MODELOS	DESDE / A	
	ENGINE	MODELS	FROM / TO	
CA-273-G	V8, OHV 16V MOTOR HEMI CABEZA DE GRAFITO	300C, CHALLENGER, CHARGER. (IZQUIERDA)	2005/2012	
5.9L	MOTOR	MODELOS	DESDE / A	
	ENGINE	MODELS	FROM / TO	
CA-249-ML	6L, OHV 12V Y 24V MOTOR CUMMINS	RAM 2500,3500 CUMMINS TURBO	2003/2008	
5.9L	MOTOR	MODELOS	DESDE / A	
	ENGINE	MODELS	FROM / TO	
CA-718-G	V8 OHV 16V 360"	AMBASSADOR, JAVELIN, MATA-DOR, CHEROKEE, WAGONEER, GRAND WAGONNER.	1971/1991	
6.4L	MOTOR	MODELOS	DESDE / A	
	ENGINE	MODELS	FROM / TO	
CA-718-G	V8 OHV 16V 390"	AMBASSADOR, JAVELIN, RAMBLER.	1971/1978	



6.6L	MOTOR	MODELOS	DESDE / A
	ENGINE	MODELS	FROM / TO
CA-718-G	V8 OHV 16V 401"	AMBASSADOR, JAVELIN, MATA-DOR, CHEROKEE, WAGONNER	1971/1983

7.2L	MOTOR	MODELOS	DESDE / A
	ENGINE	MODELS	FROM / TO
CA-258-G	V8, OHV 16V	CHARGER, CORONET, BARRA-CUDA, CHALLENGER, MONACO, CORONET, FURY	1966/1978

8.0L	MOTOR	MODELOS	DESDE / A
	ENGINE	MODELS	FROM / TO
CA-282-G	V10, OHV 20 V VIN W,E	RAM 2500, 3500, VIPER.	1992/2003

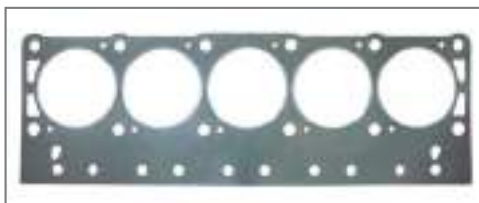



1.3L	MOTOR	MODELOS	DESDE / A	
	ENGINE	MODELS	FROM / TO	
CA-302-G	4L OHV 8V ENDURA	FIESTA.	1997/2001	
1.4L	MOTOR	MODELOS	DESDE / A	
	ENGINE	MODELS	FROM / TO	
CA-307-ML	4L DOHC 16V FHA FHD FHE FHF	FIESTA.	1998/2001	
1.4L	MOTOR	MODELOS	DESDE / A	
	ENGINE	MODELS	FROM / TO	
CA-307-G	4L SOHC 8V ZETEC SE	FIESTA.	1998/2000	
1.6L	MOTOR	MODELOS	DESDE / A	
	ENGINE	MODELS	FROM / TO	
CA-317-G	4L SOHC 8V ZETEC ROCAM	FIESTA, IKON, Ka, COURIER.	2001/2010	
1.8L	MOTOR	MODELOS	DESDE / A	
	ENGINE	MODELS	FROM / TO	
CA-303-2ML	4L DOHC 16V	ESCORT, TRACER.	1991/1996	
1.9L	MOTOR	MODELOS	DESDE / A	
	ENGINE	MODELS	FROM / TO	
CA-303-G	4L SOHC 8V	MERCURY TRACER, ESCORT.	1981/1999	
1.9L	MOTOR	MODELOS	DESDE / A	
	ENGINE	MODELS	FROM / TO	
CA-303-2G	4L SOHC 8V	ESCORT TRACER.	1991/1996	
2.0L	MOTOR	MODELOS	DESDE / A	
	ENGINE	MODELS	FROM / TO	
CA-303-1G	4L SOHC 8V	ESCORT, TRACER, FOCUS.	1981/2004	



2.0L	MOTOR	MODELOS	DESDE / A	
	ENGINE	MODELS	FROM / TO	
CA-303-1ML	4L SOHC 8V SPI VIN P	FOCUS.	2000/2004	
2.0L	MOTOR	MODELOS	DESDE / A	
	ENGINE	MODELS	FROM / TO	
CA-304-G	4L OHV	MAZDA B2000, COURIER.	1970/1984	
2.0L	MOTOR	MODELOS	DESDE / A	
	ENGINE	MODELS	FROM / TO	
CA-306-G	4L SOHC 8V CARB	RANGER.	1983/1986	
2.0L	MOTOR	MODELOS	DESDE / A	
	ENGINE	MODELS	FROM / TO	
CA-313-ML	4L DOHC 16V VIN 3 VIN Z	CONTOUR, MYSTIQUE, ESCORT,	1995/1999	
2.0L	MOTOR	MODELOS	DESDE / A	
	ENGINE	MODELS	FROM / TO	
CA-313-G	4L DOHC 16V	CONTOUR, ESCORT, FOCUS, ZX2.	1995/1997	
2.0L	MOTOR	MODELOS	DESDE / A	
	ENGINE	MODELS	FROM / TO	
CA-348-ML	4L DOHC 16V DURATEC	ECOSPORT, MEXICO.	2005/2009	
2.0L	MOTOR	MODELOS	DESDE / A	
	ENGINE	MODELS	FROM / TO	
CA-348-G	4L DOHC 16V VIN D,H	ECOSPORT, FOCUS.	2001/2010	
2.2L	MOTOR	MODELOS	DESDE / A	
	ENGINE	MODELS	FROM / TO	
CA-321-ML	4L DOHC 16V TURBODIESEL	TRANSIT VAN.	2008/2012	











2.3L	MOTOR	MODELOS	DESDE / A	
	ENGINE	MODELS	FROM / TO	
CA-300-G	4L OHV 8V VIN R S X	TEMPO, TOPAZ.	1984/1994	
2.3L	MOTOR	MODELOS	DESDE / A	
	ENGINE	MODELS	FROM / TO	
CA-305-G	4L SOHC 8V	RANGER.	1974/2002	
2.3L	MOTOR	MODELOS	DESDE / A	
	ENGINE	MODELS	FROM / TO	
CA-346-ML	4L DOHC 16V DURATEC VIN Z	FUSION, MILAN, MAZDA 3.	2006/2009	
2.4L	MOTOR	MODELOS	DESDE / A	
	ENGINE	MODELS	FROM / TO	
CA-320-G	6L OHV	FALCON, MAVERICK, CUSTOM ECONOLINE.	1960/1983	
2.5L	MOTOR	MODELOS	DESDE / A	
	ENGINE	MODELS	FROM / TO	
CA-311-ML	V6 DOHC 24V	CONTOUR, MYSTIQUE, MAZDA MPV. (DERECHA)	1995/2000	
2.5L	MOTOR	MODELOS	DESDE / A	
	ENGINE	MODELS	FROM / TO	
CA-312-ML	V6 DOHC 24V	CONTOUR, MYSTIQUE. (IZQUIERDA)	1995/2000	
2.5L	MOTOR	MODELOS	DESDE / A	
	ENGINE	MODELS	FROM / TO	
CA-319-ML	V6 DOHC 24V KL-ZE	PROBE, 626, MILLENIA. (DERECHA)	1993/1997	
2.5L	MOTOR	MODELOS	DESDE / A	
	ENGINE	MODELS	FROM / TO	
CA-319-ML1	V6 DOHC 24V KL-ZE	PROBE, 626, MILLENIA. (IZQUIERDA)	1993/1997	



2.8L	MOTOR	MODELOS	DESDE / A	
	ENGINE	MODELS	FROM / TO	
CA-315-G	V6 OHV 12V	AEROSTAR, BRONCO II, RANGER. (IZQUIERDA)	1974/1986	
2.8L	MOTOR	MODELOS	DESDE / A	
	ENGINE	MODELS	FROM / TO	
CA-316-G	V6 OHV 12V VIN Z	BRONCO II, RANGER. (DERECHA)	1974/1986	
2.8L	MOTOR	MODELOS	DESDE / A	
	ENGINE	MODELS	FROM / TO	
CA-320-G	6L OHV (144,170,200,250)	FALCON, MAVERICK, CUSTOM ECONOLINE	1960/1972	
2.9L	MOTOR	MODELOS	DESDE / A	
	ENGINE	MODELS	FROM / TO	
CA-308-G	V6 OHV 12V	EXPLORER, RANGER. (IZQUIERDA)	1986/1992	
2.9L	MOTOR	MODELOS	DESDE / A	
	ENGINE	MODELS	FROM / TO	
CA-309-G	V6 OHV 12V	EXPLORER, RANGER. (DERECHA)	1986/1992	
3.0L	MOTOR	MODELOS	DESDE / A	
	ENGINE	MODELS	FROM / TO	
CA-318-G	V6 OHV 12V VULCAN F.I.VIN U VIN 1	RANGER, AEROSTAR, TAURUS.	1986/1990	
3.0L	MOTOR	MODELOS	DESDE / A	
	ENGINE	MODELS	FROM / TO	
CA-322-G	V6 OHV 12V VIN U	AEROSTAR, B3000. (IZQUIERDA)	1986/1995	
3.0L	MOTOR	MODELOS	DESDE / A	
	ENGINE	MODELS	FROM / TO	
CA-323-G	V6 OHV 12V VIN U	AEROSTAR, B3000. (DERECHA)	1986/1995	



3.0L	MOTOR	MODELOS	DESDE / A	
	ENGINE	MODELS	FROM / TO	
CA-326-G	V6 DOHC 24V	ESCAPE, TAURUS, SABLE. (IZQUIERDA)	1999/2004	
3.0L	MOTOR	MODELOS	DESDE / A	
	ENGINE	MODELS	FROM / TO	
CA-326-ML	V6 DOHC DURATEC	TAURUS, SABLE. (IZQUIERDA)	2001/2004	
3.0L	MOTOR	MODELOS	DESDE / A	
	ENGINE	MODELS	FROM / TO	
CA-327-G	V6 DOHC 24V	ESCAPE, TAURUS, SABLE. (DERECHA)	2001/2004	
3.0L	MOTOR	MODELOS	DESDE / A	
	ENGINE	MODELS	FROM / TO	
CA-327-ML	V6 DOHC DURATEC	TAURUS, SABLE. (DERECHA)	2001/2004	
3.5L	MOTOR	MODELOS	DESDE / A	
	ENGINE	MODELS	FROM / TO	
CA-310-G	V6 OHV 12V	CUSTOM, WAGON PICK-UP.	1954-1964	
3.8L	MOTOR	MODELOS	DESDE / A	
	ENGINE	MODELS	FROM / TO	
CA-330-G	V6 OHV 12 CARB.	FORD FAIRMONT.	1982/1983	
3.8L	MOTOR	MODELOS	DESDE / A	
	ENGINE	MODELS	FROM / TO	
CA-332-1G	V6 OHV 12V MPFI	WINDSTAR.	1994/1995	
3.8L	MOTOR	MODELOS	DESDE / A	
	ENGINE	MODELS	FROM / TO	
CA-332-G	V6 OHV 12V MPFI	WINDSTAR.	1994/1995	



3.8L	MOTOR	MODELOS	DESDE / A	
	ENGINE	MODELS	FROM / TO	
CA-341-ML	V6 OHV 12V VIN 2,4	MUSTANG, WINDSTAR, LOBO F-150. (IZQUIERDA)	1995/2003	
3.8L	MOTOR	MODELOS	DESDE / A	
	ENGINE	MODELS	FROM / TO	
CA-341-G	V6 OHV 12V VIN 2,4	WINDSTAR, ECONOLINE. (IZQUIERDA)	1997/1998	
3.8L	MOTOR	MODELOS	DESDE / A	
	ENGINE	MODELS	FROM / TO	
CA-342-ML	V6 OHV 12V VIN 2,4	MUSTANG, WINDSTAR, LOBO F-150. (DERECHA)	1995/2003	
3.8L	MOTOR	MODELOS	DESDE / A	
	ENGINE	MODELS	FROM / TO	
CA-342-G	V6 OHV 12V VIN 2,4	WINDSTAR, ECONOLINE. (DERECHA)	1997/1998	
3.9L	MOTOR	MODELOS	DESDE / A	
	ENGINE	MODELS	FROM / TO	
CA-325-G	6L OHV 12V CARB.	AUTOS Y CAMIONETAS.	1965/1986	
4.0L	MOTOR	MODELOS	DESDE / A	
	ENGINE	MODELS	FROM / TO	
CA-335-G	V6 OHV 12V VIN X	AEROSTAR, EXPLORER, RANGER. (IZQUIERDA)	1990/2000	
4.0L	MOTOR	MODELOS	DESDE / A	
	ENGINE	MODELS	FROM / TO	
CA-336-G	V6 OHV 12V VIN X	AEROSTAR, EXPLORER, RANGER. (DERECHA)	1990/2000	
4.0L	MOTOR	MODELOS	DESDE / A	
	ENGINE	MODELS	FROM / TO	
CA-337-G	V6 SOHC 12V VIN E,K	EXPLORER, RANGER. (IZQUIERDA)	1997/2010	



4.0L	MOTOR	MODELOS	DESDE / A	
	ENGINE	MODELS	FROM / TO	
CA-338-G	V6 SOHC 12V VIN E,K	EXPLORER, RANGER. (DERECHA)	1997/2010	
4.0L	MOTOR	MODELOS	DESDE / A	
	ENGINE	MODELS	FROM / TO	
CA-337-ML	V6 OHV 12V VIN E,K	EXPLORER, MONTAINNER. (IZQUIERDA)	1997/2010	
4.0L	MOTOR	MODELOS	DESDE / A	
	ENGINE	MODELS	FROM / TO	
CA-338-ML	V6 OHV 12V VIN E,K	EXPLORER, MONTAINNER. (DERECHA)	1997/2010	
4.2L	MOTOR	MODELOS	DESDE / A	
	ENGINE	MODELS	FROM / TO	
CA-340-L	V8 OHV	AUTOS MERCURY. (IZQUIERDA).	1949/1954	
4.2L	MOTOR	MODELOS	DESDE / A	
	ENGINE	MODELS	FROM / TO	
CA-340-R	V8 OHV	AUTOS MERCURY. (DERECHA).	1949/1954	
4.4L	MOTOR	MODELOS	DESDE / A	
	ENGINE	MODELS	FROM / TO	
CA-350-B	V8 OHV 16V (272-292)	AUTOS Y CAMIONES.	1956/1964	
4.6L	MOTOR	MODELOS	DESDE / A	
	ENGINE	MODELS	FROM / TO	
CA-356-ML	V8 SOHC 16V TRITON	GRAND MARQUIS, F-150, F250, LOBO. (IZQUIERDA)	1991/2007	
4.6L	MOTOR	MODELOS	DESDE / A	
	ENGINE	MODELS	FROM / TO	
CA-357-ML	V8 SOHC 16V TRITON	GRAND MARQUIS, F-150, F250, LOBO. (DERECHA).	1991/2007	



4.6L	MOTOR	MODELOS	DESDE / A	
	ENGINE	MODELS	FROM / TO	
CA-357-ML1	V8 SOHC 16V TRITON	AUTOS Y CAMIONES MLS 4 CAPAS, F-150, F250, LOBO. (DERECHA)	1991/2007	
4.6L	MOTOR	MODELOS	DESDE / A	
	ENGINE	MODELS	FROM / TO	
CA-356-ML1	V8 SOHC 16V TRITON	AUTOS Y CAMIONES MLS 4 CAPAS, F-150, F250, LOBO. (IZQUIERDA)	1991/2007	
4.6L	MOTOR	MODELOS	DESDE / A	
	ENGINE	MODELS	FROM / TO	
CA-356-G	V8 SOHC 16V TRITON ROMEO	C.VICTORIA, CONTINENTAL, GRAND MARQUIS. (IZQUIERDA)	1991/1994	
4.6L	MOTOR	MODELOS	DESDE / A	
	ENGINE	MODELS	FROM / TO	
CA-357-G	V8 SOHC 16V TRITON	GRAND MARQUIS, F-150, F250, LOBO. (DERECHA)	1991/2007	
5.0L	MOTOR	MODELOS	DESDE / A	
	ENGINE	MODELS	FROM / TO	
CA-360-G	V8 OHV 16V 260,289,302,335,351,351W	AUTOS Y CAMIONES. (DERECHA)	1962/1997	
5.4L	MOTOR	MODELOS	DESDE / A	
	ENGINE	MODELS	FROM / TO	
CA-355-G	V8 OHV 16V (332-)-352-360-390-410-427-428	AUTOS Y CAMIONES.	1961/1976	
5.4L	MOTOR	MODELOS	DESDE / A	
	ENGINE	MODELS	FROM / TO	
CA-356-ML1	V8 SOHC 16V TRITON	AUTOS Y CAMIONES MLS 4 CAPAS, F-150, F250, LOBO. (IZQUIERDA)	1991/2007	
5.4L	MOTOR	MODELOS	DESDE / A	
	ENGINE	MODELS	FROM / TO	
CA-357-ML1	V8 SOHC 16V TRITON	AUTOS Y CAMIONES MLS 4 CAPAS, F-150, F250, LOBO. (DERECHA)	1991/2007	



5.4L	MOTOR	MODELOS	DESDE / A	
	ENGINE	MODELS	FROM / TO	
CA-356-ML	V8 SOHC 16V TRITON	F-250, F-150, LOBO , G, MARQUIS. (IZQUIERDA)	1991/2007	
5.4L	MOTOR	MODELOS	DESDE / A	
	ENGINE	MODELS	FROM / TO	
CA-357-ML	V8 SOHC 16V TRITON	F-250, F-150, LOBO , G, MARQUIS. (IZQUIERDA)	1991/2007	
5.4L	MOTOR	MODELOS	DESDE / A	
	ENGINE	MODELS	FROM / TO	
CA-356-G	V8 SOHC 16V TRITON	F-150, F250, LOBO. (DERECHA)	1991/2009	
5.4L	MOTOR	MODELOS	DESDE / A	
	ENGINE	MODELS	FROM / TO	
CA-357-G	V8 SOHC 16V TRITON	F-150, F250, LOBO. (DERECHA)	1991/2009	
5.4L	MOTOR	MODELOS	DESDE / A	
	ENGINE	MODELS	FROM / TO	
CA-356-1G	V8 SOHC 24V TRITON VIN V,5,	EXPEDITION , LOBO, F-150, F-250 NAVIGATOR. (IZQUIERDA)	2004/2010	
5.4L	MOTOR	MODELOS	DESDE / A	
	ENGINE	MODELS	FROM / TO	
CA-357-1G	V8 SOHC 24V TRITON VIN V,5,	EXPEDITION , LOBO, F-150, F-250 NAVIGATOR. (DERECHA)	2004/2010	
5.8L	MOTOR	MODELOS	DESDE / A	
	ENGINE	MODELS	FROM / TO	
CA-365-G	V8 OHV 16V (351W)	TRUCKS, GALAXIE, GRAND MARQUIS.	1969/1983	
5.8L	MOTOR	MODELOS	DESDE / A	
	ENGINE	MODELS	FROM / TO	
CA-370-G	V8 OHV 16V (351C,400) CARB.	F-150, PICK-UP, TRUCKS.	1970/1982	



6.1L	MOTOR	MODELOS	DESDE / A	
	ENGINE	MODELS	FROM / TO	
CA-380-G	V8 OHV 16V (370,389 CID)	CAMIONES.	1979/1989	
6.8L	MOTOR	MODELOS	DESDE / A	
	ENGINE	MODELS	FROM / TO	
CA-390-ML	V10 OHV 16V TRITON (415CID)	TRUCKS, F-450 SUPER DUTY, EXCURSION. (IZQUIERDA)	1997/2003	
6.8L	MOTOR	MODELOS	DESDE / A	
	ENGINE	MODELS	FROM / TO	
CA-391-ML	V10 SOHC 20V TRITON	ECONOLINE, SUPER DUTY , F-450. (DERECHA)	1997/2003	
6.8L	MOTOR	MODELOS	DESDE / A	
	ENGINE	MODELS	FROM / TO	
CA-390-G	V10 OHV 16V TRITON (415CID)	TRUCKS, F-450 SUPER DUTY. (IZQUIERDA)	1997/1999	
6.8L	MOTOR	MODELOS	DESDE / A	
	ENGINE	MODELS	FROM / TO	
CA-391-G	V10 SOHC 20V TRITON	F-450,SUPER DUTY. (DERECHA)	1999/2007	
7.0L	MOTOR	MODELOS	DESDE / A	
	ENGINE	MODELS	FROM / TO	
CA-375-G	V8 OHV 16V (429,460)	GALAXIE, CUSTOM 500, F-350, F-600.	1968/1985	
7.3L	MOTOR	MODELOS	DESDE / A	
	ENGINE	MODELS	FROM / TO	
CA-376-G	V8 OHV 16V (INTERNATIONAL)	F SUPER DUTY ,F-250-E250-E-350	1988/1995	
7.3L	MOTOR	MODELOS	DESDE / A	
	ENGINE	MODELS	FROM / TO	
CA-396-1G	V8 OHV DIESEL INTERNATIO-NAL	E-250, E-350, ECONOLINE.	1994-2003	



7.5L	MOTOR	MODELOS	DESDE / A	
	ENGINE	MODELS	FROM / TO	
CA-375-G	V8 OHV 16V (427,460)	GALAXIE, CUSTOM 500, F-350, F-700.	1968/1985	



1.0L	MOTOR	MODELOS	DESDE / A	
	ENGINE	MODELS	FROM / TO	
CA-95-G	3L SOHC 6V 61" SA310	SPRINT, FIREFLY, FORSA.	1985/1988	
1.0L	MOTOR	MODELOS	DESDE / A	
	ENGINE	MODELS	FROM / TO	
CA-95-1G	3L SOHC 6v 61"	GEO METRO, SWIFT.	1989/1997	
1.0L	MOTOR	MODELOS	DESDE / A	
	ENGINE	MODELS	FROM / TO	
CA-116-G	4L SOHC 8V DAEWOO ENGINE	MATIZ G2.	2004/2010	
1.2L	MOTOR	MODELOS	DESDE / A	
	ENGINE	MODELS	FROM / TO	
CA-119-ML	4L DOHC 16V	SPARK.	2011/2013	
1.4L	MOTOR	MODELOS	DESDE / A	
	ENGINE	MODELS	FROM / TO	
CA-100-G	4L SOHC 8V	CHEVY POP, JOY, SWING.	1994/2001	
1.4L	MOTOR	MODELOS	DESDE / A	
	ENGINE	MODELS	FROM / TO	
CA-101-G	4L SOHC 8V VIN I	PONTIAC ACADIAN, T1000, CHEVETTE.	1976/1987	
1.6L	MOTOR	MODELOS	DESDE / A	
	ENGINE	MODELS	FROM / TO	
CA-100-1G	4L SOHC 8V	CHEVY MONZA, PICK-UP.	1996/2010	
1.6L	MOTOR	MODELOS	DESDE / A	
	ENGINE	MODELS	FROM / TO	
CA-101-G	4L SOHC 8V VIN I	PONTIAC ACADIAN, T1000, CHEVETTE.	1976/1987	



1.6L	MOTOR	MODELOS	DESDE / A	
	ENGINE	MODELS	FROM / TO	
CA-102-1G	4L DOHC 16V VIN 6 E-TEC	AVEO, PONTIAC G3 (CABEZA DE GRAFITO).	2008/2012	
1.6L	MOTOR	MODELOS	DESDE / A	
	ENGINE	MODELS	FROM / TO	
CA-102-1ML	4L DOHC 16V VIN 6 E-TEC	AVEO, PONTIAC G3 (CABEZA DE MLS).	2008/2012	
1.6L	MOTOR	MODELOS	DESDE / A	
	ENGINE	MODELS	FROM / TO	
CA-103-G	4L SOHC 8V 98" VIN 4	CHEVY NOVA.	1986/1988	
1.6L	MOTOR	MODELOS	DESDE / A	
	ENGINE	MODELS	FROM / TO	
CA-402-G	4L SOHC 8V (USA)	TRACKER, SIDEKICK, SWIFT.	1989/2002	
1.8L	MOTOR	MODELOS	DESDE / A	
	ENGINE	MODELS	FROM / TO	
CA-102-G	4L SOHC 8V MOTOR G180Z G200Z	S10, PICK-UP, BLAZER, TROOPER.	1972/1982	
1.8L	MOTOR	MODELOS	DESDE / A	
	ENGINE	MODELS	FROM / TO	
CA-104-G	4L SOHC 8V PRIMER DISEÑO	CAVALIER, FIRENZA, SKYHAWK, SUNBIRD.	1982	
1.8L	MOTOR	MODELOS	DESDE / A	
	ENGINE	MODELS	FROM / TO	
CA-107-G	4L SOHC 8V 112" VIN J	SUNBIRD, FIRENZA, J2000.	1982/1986	
1.8L	MOTOR	MODELOS	DESDE / A	
	ENGINE	MODELS	FROM / TO	
CA-114-G	4L DOHC 16V 110" MOTOR X18XE1	ASTRA, ZAFIRA, (CABEZA DE GRAFITO).	2000/2008	



1.8L	MOTOR	MODELOS	DESDE / A	
	ENGINE	MODELS	FROM / TO	
CA-114-ML	4L DOHC 16V X18XE1	ASTRA HATCHBACK (CABEZA DE MLS).	2000/2008	
1.8L	MOTOR	MODELOS	DESDE / A	
	ENGINE	MODELS	FROM / TO	
CA-118-G	4L SOHC 8V	CORSA, PICK-UP TORNADO.	2003/2006	
1.8L	MOTOR	MODELOS	DESDE / A	
	ENGINE	MODELS	FROM / TO	
CA-122-ML	4L DOHC 16V	CRUZE, SONIC. (CABEZA DE MLS).	2011/2013	
1.8L	MOTOR	MODELOS	DESDE / A	
	ENGINE	MODELS	FROM / TO	
CA-122-G	4L DOHC 16V MOTOR ECOTEC LUW	CRUZE, SONIC. (CABEZA DE GRAFITO).	2011/2013	
1.9L	MOTOR	MODELOS	DESDE / A	
	ENGINE	MODELS	FROM / TO	
CA-102-G	4L SOHC 8V MOTOR G180Z G200Z	S10, PICK-UP, BLAZER, TROOPER.	1982/1985	
1.9L	MOTOR	MODELOS	DESDE / A	
	ENGINE	MODELS	FROM / TO	
CA-111-G	4L SOHC 8V 116" MFI VIN 8 9	SATURN.	1991/2002	
1.9L	MOTOR	MODELOS	DESDE / A	
	ENGINE	MODELS	FROM / TO	
CA-115-G	4L DOHC 16V 116"	SATURN SC2, SL2, SC, SL2.	1991/1995	
2.0L	MOTOR	MODELOS	DESDE / A	
	ENGINE	MODELS	FROM / TO	
CA-104-G	4L SOHC 8V PRIMER DISEÑO	CAVALIER, FIRENZA, SKYHAWK, SUNBIRD.	1983/1987	



2.0L	MOTOR	MODELOS	DESDE / A	
	ENGINE	MODELS	FROM / TO	
CA-107-G	4L SOHC 8V 122"	J2000, SUNBIRD.	1982/1986	
2.0L	MOTOR	MODELOS	DESDE / A	
	ENGINE	MODELS	FROM / TO	
CA-108-G	4L OHV 8V 122"	CAVALIER USA, PICK-UP S10, BLAZER, BERETTA, CORSICA.	1987/1989	
2.0L	MOTOR	MODELOS	DESDE / A	
	ENGINE	MODELS	FROM / TO	
CA-117-ML	4L DOHC 16V	OPTRA, ASTRA, FORENZA.	2004/2010	
2.0L	MOTOR	MODELOS	DESDE / A	
	ENGINE	MODELS	FROM / TO	
CA-117-G	4L SOHC/DOHC 8V;16V	ASTRA, OPTRA.	2004/2008	
2.0L	MOTOR	MODELOS	DESDE / A	
	ENGINE	MODELS	FROM / TO	
CA-133-ML	4L DOHC 16V	TRACKER, VITARA (CABEZA DE MLS).	1999/2003	
2.2L	MOTOR	MODELOS	DESDE / A	
	ENGINE	MODELS	FROM / TO	
CA-108-G	4L OHV 8V 134"	CAVALIER USA, PICK-UP S10, BLAZER, BERETTA, CORSICA.	1990/1991	
2.2L	MOTOR	MODELOS	DESDE / A	
	ENGINE	MODELS	FROM / TO	
CA-112-G	4L OHV 8V 134"	S-10, BLAZER, SONOMA, ISUZU HOMBRE.	1994/1997	
2.2L	MOTOR	MODELOS	DESDE / A	
	ENGINE	MODELS	FROM / TO	
CA-113-G	4L DOHC 16V ECOTEC	ASTRA, ZAFIRA, SUNFIRE, CAVALIER, HHR (CABEZA DE GRAFITO).	2001/2008	



2.2L	MOTOR	MODELOS	DESDE / A	
	ENGINE	MODELS	FROM / TO	
CA-113-ML	4L DOHC 16V ECOTEC	ASTRA, ZAFIRA, SUNFIRE, CAVALIER, HHR (CABEZA DE MLS).	2001/2008	
2.3L	MOTOR	MODELOS	DESDE / A	
	ENGINE	MODELS	FROM / TO	
CA-109-G	4L DOHC 16V QUAD4 VIN A 3	PONTIAC SUNFIRE, CUTLASS, BERETTA, GRAND AM, GRAND PRIX, CALAIS, SKYLARK.	1987/1991	
2.3L	MOTOR	MODELOS	DESDE / A	
	ENGINE	MODELS	FROM / TO	
CA-1710-G	4L SOHC 8V MOTOR 4ZD1 VIN L	AMIGO, TROOPER, IMPULSE, PICK UP. LUV.	1997/1998	
2.4L	MOTOR	MODELOS	DESDE / A	
	ENGINE	MODELS	FROM / TO	
CA-109-1G	4L DOHC 16V QUAD4 VIN T	PONTIAC SUNFIRE, GRAND AM, CAVALIER.	1997/2002	
2.4L	MOTOR	MODELOS	DESDE / A	
	ENGINE	MODELS	FROM / TO	
CA-109-2G	4L DOHC 16V QUAD4 VIN T MOTOR LD9	ALERO, CAVALIER, MALIBU, PONTIAC GRAND AM, SUNFIRE.	1999/2002	
2.4L	MOTOR	MODELOS	DESDE / A	
	ENGINE	MODELS	FROM / TO	
CA-117-ML	4L DOHC 16V	PONTIAC G4, ASTRA.	2004/2006	
2.5L	MOTOR	MODELOS	DESDE / A	
	ENGINE	MODELS	FROM / TO	
CA-105-G	4L OHV 8V 151" VIN 2 R	PONTIAC SPIRIT USA, AMX MEXICO, CAMARO, CELEBRITY, CITATION, CJ5, CJ7.	1979/1983	
2.5L	MOTOR	MODELOS	DESDE / A	
	ENGINE	MODELS	FROM / TO	
CA-106-G	4L OHV 8V 151" VIN R 2	CENTURY, SKYLARK, GRAND AM.	1985/1986	



2.7L	MOTOR	MODELOS	DESDE / A	
	ENGINE	MODELS	FROM / TO	
CA-123-G	V6 DOHC 24V H27A	VITARA, GRAND VITARA.	2006/2010	
2.7L	MOTOR	MODELOS	DESDE / A	
	ENGINE	MODELS	FROM / TO	
CA-123-1G	V6 DOHC 24V H27A	VITARA, GRAND VITARA.	2006/2010	
2.8L	MOTOR	MODELOS	DESDE / A	
	ENGINE	MODELS	FROM / TO	
CA-126-ML	4L DOHC 16V VIN "8" MOTOR LK5	COLORADO	2004/2006.	
2.8L	MOTOR	MODELOS	DESDE / A	
	ENGINE	MODELS	FROM / TO	
CA-140-G	V6 OHV 12V 173" VIN B X Z 1 7	CITATION, CELEBRITY, CENTURY, CAMARO, JEEP, EAGLE (USA), PONTIAC FIERO, CAMION.	1980/1995	
2.8L	MOTOR	MODELOS	DESDE / A	
	ENGINE	MODELS	FROM / TO	
CA-141-G	V6 OHV 12V	MPFI 2a GENERACION, CAVALIER, CUTLASS, EUROSPORT, CENTURY.	1988/1994	
2.9L	MOTOR	MODELOS	DESDE / A	
	ENGINE	MODELS	FROM / TO	
CA-127-ML	DOHC 16V	COLORADO PICK-UP.	2007/2009	
3.1L	MOTOR	MODELOS	DESDE / A	
	ENGINE	MODELS	FROM / TO	
CA-141-G	V6 OHV 12V VIN T	CAVALIER, GRAND AM, CUTLASS.	1988/2001	
3.1L	MOTOR	MODELOS	DESDE / A	
	ENGINE	MODELS	FROM / TO	
CA-145-G	V6 OHV 12V VIN "J"	CUTLASS, BERETTA, MONTE CARLO, LUMINA.	1993/2007	



3.3L	MOTOR	MODELOS	DESDE / A	
	ENGINE	MODELS	FROM / TO	
CA-146-G	V6 OHV 12V 189" VIN N L	PONTIAC GRAND AM, BUICK CENTURY, OLDSMOBILE CUTLAS CIERA, PONTIAC BONNEVILLE, BUICK LESABRE, REGAL, RIVERA, CHEVROLET LUMINA APV.	1990/1991	
3.4L	MOTOR	MODELOS	DESDE / A	
	ENGINE	MODELS	FROM / TO	
CA-172-G	V6 DOHC 24V 207"	MONTE CARLO, OLDSMOBILE CUTLASS SUPREME, PONTIAC GRAND PRIX.	1991/1995	
3.4L	MOTOR	MODELOS	DESDE / A	
	ENGINE	MODELS	FROM / TO	
CA-173-G	V6 OHV 12V VIN "E""S"	VENTURE, GRAND AM, IMPALA.	1996/2003	
3.5L	MOTOR	MODELOS	DESDE / A	
	ENGINE	MODELS	FROM / TO	
CA-110-S	6L OHV 12V 216"	BEL AIR, FLEETMASTER, TWO-TEN SERIES, AUTOS Y CAMIONES TODOS.	1937/1953	
3.5L	MOTOR	MODELOS	DESDE / A	
	ENGINE	MODELS	FROM / TO	
CA-128-ML	5L DOHC 20 V 211" VIN 6	COLORADO, CANYON, H3, i-350.	2004/2006	
3.5L	MOTOR	MODELOS	DESDE / A	
	ENGINE	MODELS	FROM / TO	
CA-156-G	V6 DOHC 24V VIN H	AURORA, INTRIGUE. (IZQUIERDA)	1999/2002	
3.5L	MOTOR	MODELOS	DESDE / A	
	ENGINE	MODELS	FROM / TO	
CA-156-1G	V6 DOHC 24V VIN H	AURORA, INTRIGUE. (DERECHA)	1999/2002	
3.6L	MOTOR	MODELOS	DESDE / A	
	ENGINE	MODELS	FROM / TO	
CA-183-ML	V6 DOHC 24V 217"	ACADIA, EQUINOX, MALIBU, G6, G8, TORRENT, CADILLAC CTS, SRX Y STS.	2004/2011	



3.6L	MOTOR	MODELOS	DESDE / A
	ENGINE	MODELS	FROM / TO
CA-183-1ML	V6 DOHC 24V	EQUINOX, MALIBU, TORRENT.	2008/2010



3.7L	MOTOR	MODELOS	DESDE / A
	ENGINE	MODELS	FROM / TO
CA-129-ML	5L DOHC 20V VIN E	COLORADO, CANYON, ISUZU I-370, HUMMER H3.	2007/2012



3.8L	MOTOR	MODELOS	DESDE / A
	ENGINE	MODELS	FROM / TO
CA-120-S	6L OHV 12V 235"	BEL AIR, AUTOS & CAMIONES.	1953/1962

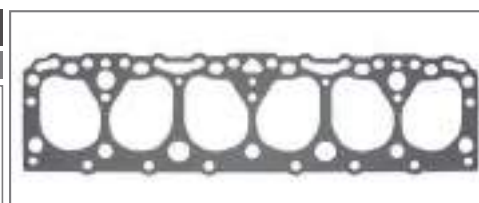

3.8L	MOTOR	MODELOS	DESDE / A
	ENGINE	MODELS	FROM / TO
CA-142-G	V6 OHV 12V VIN A B C 3 4 6 7 8 9	AUTOS BUICK, CUTLASS, MONTE CARLO, MALIBU.	1977/1982



3.8L	MOTOR	MODELOS	DESDE / A
	ENGINE	MODELS	FROM / TO
CA-143-G	V6 OHV 12V VIN K 9	MALIBU, IMPALA, CAPRICE, PONTIAC LeMANS.	1980/1984

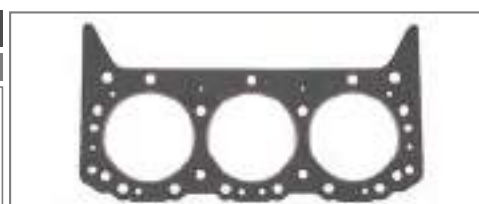

3.8L	MOTOR	MODELOS	DESDE / A
	ENGINE	MODELS	FROM / TO
CA-146-G	V6 OHV 12V VIN L	PONTIAC GRAND AM, BUICK CENTURY, OLDSMOBILE CUTLASS CIERA, PONTIAC BONNEVILLE, BUICK LESABRE, REGAL, RIVERA, CHEVROLET LUMINA APV.	1991/1993



3.8L	MOTOR	MODELOS	DESDE / A
	ENGINE	MODELS	FROM / TO
CA-147-G	V6 OHV 12V 231" VIN C	ELECTRA, LE SABRE, REATTA, RIVERA.	1988/1990



3.8L	MOTOR	MODELOS	DESDE / A
	ENGINE	MODELS	FROM / TO
CA-148-G	V6 OHV 12V 231" VIN K	GRAND PRIX, LeSABRE, MONTE CARLO, LUMINA, REGAL, BONNEVILLE. (IZQUIERDA)	1997/2005

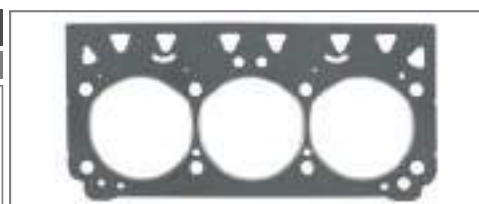



3.8L	MOTOR	MODELOS	DESDE / A		
	ENGINE	MODELS	FROM / TO		
CA-149-G	V6 OHV 12V 231" VIN K	BUICK LE SABRE, REGAL, RIVIERA, PONTIAC GRAND PRIX, LUMINA, MONTE CARLO, IMPALA. (DERECHA)	1995/2005		
3.8L	MOTOR	MODELOS	DESDE / A		
	ENGINE	MODELS	FROM / TO		
CA-149-1G	V6 OHV 12V 231" VIN 1 4 MOTOR L67.	PARK AVENUE, REGAL, RIVIERA, IMPALA, GRAND PRIX (SUPER-CARGADOS).	1997/2005		
4.0L	MOTOR	MODELOS	DESDE / A		
	ENGINE	MODELS	FROM / TO		
CA-139-1G	V8 DOHC 32V 244"	AURORA, OLDSMOBILE ;SHELBY. (DERECHA)	1995/2003		
4.0L	MOTOR	MODELOS	DESDE / A		
	ENGINE	MODELS	FROM / TO		
CA-139-G	V8 DOHC 32V 244"	AURORA, OLDSMOBILE ;SHELBY. (IZQUIERDA)	1995/2003		
4.1L	MOTOR	MODELOS	DESDE / A		
	ENGINE	MODELS	FROM / TO		
CA-130-G	6L OHV 12V	AUTOS Y CAMIONES.	1963/1992		
4.1L	MOTOR	MODELOS	DESDE / A		
	ENGINE	MODELS	FROM / TO		
CA-132-G	6L OHV 12V	SERIES C10, C20, C30, K10, K20.	1979		
4.2L	MOTOR	MODELOS	DESDE / A		
	ENGINE	MODELS	FROM / TO		
CA-153-ML	6L DOHC 24V 256" VIN S	TRAILBLAZER, ENVOY, ASCENDER, BRAVADA (CABEZA DE MLS).	2002/2006		
4.2L	MOTOR	MODELOS	DESDE / A		
	ENGINE	MODELS	FROM / TO		
CA-153-G	6LDOHC 24V 256" MOTOR VORTEC VIN S	TRAILBLAZER, ENVOY, ASCENDER, BRAVADA (CABEZA DE GRAFITO).	2002/2006		



4.3L	MOTOR	MODELOS	DESDE / A	
	ENGINE	MODELS	FROM / TO	
CA-125-B	6L OHV 12V 261"	PICK-UP K10, K20, CAMION.	1954/1962	

4.3L	MOTOR	MODELOS	DESDE / A	
	ENGINE	MODELS	FROM / TO	
CA-144-G	V6 OHV 12V VIN Z	ASTRO, PICKUP S-10, C10, C20, C1500, C2500, SAFARI, CAPRICE, EL CAMINO.	1985/1990	

4.3L	MOTOR	MODELOS	DESDE / A	
	ENGINE	MODELS	FROM / TO	
CA-151-G	V8 V8 OHV 16V 265" MOTOR VORTEC	CAPRICE.	1994/1996	

4.3L	MOTOR	MODELOS	DESDE / A	
	ENGINE	MODELS	FROM / TO	
CA-162-G	V8 OHV 16V VIN 8 F	CUTLASS, BROGHAM, CALAIS, CRUSIER, SALON, DELTA 88, OMEGA.	1977/1982	

4.6L	MOTOR	MODELOS	DESDE / A	
	ENGINE	MODELS	FROM / TO	
CA-174-G	V8 DOHC 32V 279" MOTOR NORTHSTAR VIN A 4 9	CADILLAC DEVILLE, ELDERADO, SEVILLE, PONTIAC BONEVILLE. (DERECHA)	2000/2001	

4.6L	MOTOR	MODELOS	DESDE / A	
	ENGINE	MODELS	FROM / TO	
CA-174-1G	V8 DOHC 32V 279" MOTOR NORTHSTAR VIN A 4 9	CADILLAC DEVILLE, ELDERADO, SEVILLE, PONTIAC BONEVILLE. (IZQUIERDA)	2000/2001	

4.8L	MOTOR	MODELOS	DESDE / A	
	ENGINE	MODELS	FROM / TO	
CA-130-G	6L OHV 12V	AUTOS Y CAMIONES.	1963/1992	

4.8L	MOTOR	MODELOS	DESDE / A	
	ENGINE	MODELS	FROM / TO	
CA-175-G	V8 SOHC 16V VORTEC VIN VT	CHEYENNE, SILVERADO 1500, 2500, SUBURBAN, YUKON, SIERRA 1500, 2500, TAHOE (CABEZAS DE GRAFITO).	1999/2001	





4.8L	MOTOR	MODELOS	DESDE / A	
	ENGINE	MODELS	FROM / TO	
CA-175-ML	V8 OHV 16V VIN B M P T V	CHEYENNE, SILVERADO 1500, 2500, SUBURBAN, YUKON, SIERRA 1500, 2500, TAHOE (CABEZAS DE MLS).	1999/2001	
4.9L	MOTOR	MODELOS	DESDE / A	
	ENGINE	MODELS	FROM / TO	
CA-170-B	V8 OHV 16V 301"	BUICK, ELECTRA, LESABRE, SKYLARK, PONTIAC LEMANS, VENTURA.	1977/1981	
5.0L	MOTOR	MODELOS	DESDE / A	
	ENGINE	MODELS	FROM / TO	
CA-160-G	V8 OHV 16V 305"	AUTOS Y CAMIONES.	1976/1980	
5.0L	MOTOR	MODELOS	DESDE / A	
	ENGINE	MODELS	FROM / TO	
CA-163-T	V8 OHV 16V MOTOR OLDSMOBILE 307"	BUICK, CADILLAC, CHEVROLET, OLDSMOBILE.	1980/1984	
5.3L	MOTOR	MODELOS	DESDE / A	
	ENGINE	MODELS	FROM / TO	
CA-175-ML	V8 OHV 16V VIN B M P T V	CHEYENNE, SILVERADO 1500, 2500, SUBURBAN, YUKON, SIERRA 1500, 2500, TAHOE (CABEZAS DE MLS).	1999/2001	
5.3L	MOTOR	MODELOS	DESDE / A	
	ENGINE	MODELS	FROM / TO	
CA-175-G	V8 SOHC 16V VORTEC VIN V T	CHEYENNE, SILVERADO 1500, 2500, SUBURBAN, YUKON, SIERRA 1500, 2500, TAHOE (CABEZAS DE GRAFITO).	1999/2001	
5.7L	MOTOR	MODELOS	DESDE / A	
	ENGINE	MODELS	FROM / TO	
CA-150-G	V8 OHV 16V VORTEC MEXICO TBI	MICROBUS, SUBURBAN, C-2500, C-3500, PICK-UP SOLO MEXICO.	1992/1998	
5.7L	MOTOR	MODELOS	DESDE / A	
	ENGINE	MODELS	FROM / TO	
CA-151-1G	V8 OHV 16V VIN P LT1	FIREBIRD, CAMARO Z28, CAPRICE.	1992/1997	



5.7L	MOTOR	MODELOS	DESDE / A	
	ENGINE	MODELS	FROM / TO	
CA-164-G	V8 OHV 16V 350"	APOLLO, OMEGA, CENTURY, ELECTRA, LE SABRE, OLDSMOBILE, BUICK.	1968/1980	
5.7L	MOTOR	MODELOS	DESDE / A	
	ENGINE	MODELS	FROM / TO	
CA-165-T	V8 OHV 16V 350" VIN R	CADILLAC SEVILLE.	1976	
6.0L	MOTOR	MODELOS	DESDE / A	
	ENGINE	MODELS	FROM / TO	
CA-176-G	V8 SOHC 16V VORTEC VIN U	SILVERADO 2500, SIERRA 2500, YUKON, EXPRESS VAN, CARGO VAN, SUBURBAN (CABEZA DE GRAFITO).	1999/2000	
6.0L	MOTOR	MODELOS	DESDE / A	
	ENGINE	MODELS	FROM / TO	
CA-176-ML	V8 SOHC 16V VORTEC VIN U	SILVERADO 2500, SIERRA 2500, YUKON, EXPRESS VAN, CARGO VAN, SUBURBAN (CABEZAS DE MLS).	1999/2000	
6.2L	MOTOR	MODELOS	DESDE / A	
	ENGINE	MODELS	FROM / TO	
CA-179-G	V8 OHV 16V VIN C X J	SUBURBAN 1500, 2500, 3500, PICK UP K1500, 2500, 3500, C1500, C2500, C3500, HUMMER.	1982/1993	
6.5L	MOTOR	MODELOS	DESDE / A	
	ENGINE	MODELS	FROM / TO	
CA-180-GD	V8 OHV 16V VIN F P S Y Z	PICK UP C1500, C2500, C3500, K1500, K2500, K3500, EXPRESS 2500, 3500, SAVANA, YUKON, TAHOE, HUMMER H1.	1994/2005	
6.6L	MOTOR	MODELOS	DESDE / A	
	ENGINE	MODELS	FROM / TO	
CA-155-G	V8 OHV 16V "401" BLOCK CHICO	MONTE CARLO, IMPALA, CHEVLE NOMAD, CAPRICE, BEL AIR, CAMARO, EL CAMINO, PONTIAC FIREBIRD, BONNEVILLE.	1970/1976	
7.0L	MOTOR	MODELOS	DESDE / A	
	ENGINE	MODELS	FROM / TO	
CA-167-G	V8 OHV 16V 427"	CAMARO, CORVETTE, CAPRICE, IMPALA.	1965/1969	

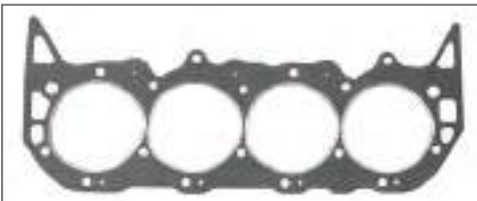

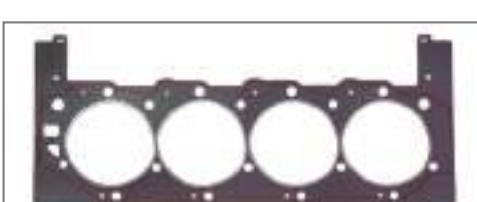
7.4L	MOTOR	MODELOS	DESDE / A	
	ENGINE	MODELS	FROM / TO	
CA-167-G	V8 OHV 16V 454"	AUTOS Y CAMIONES.	1970/1980	
7.4L	MOTOR	MODELOS	DESDE / A	
	ENGINE	MODELS	FROM / TO	
CA-168-G	V8 OHV 16V 454"	PICK UP C1500, C2500, C3500.	1980/1985	
	MOTOR	MODELOS	DESDE / A	
	ENGINE	MODELS	FROM / TO	
CA-169-G	V8 OHV 16V 454" VORTEC VIN C	KODIAK C2500, C3500, K2500, K3500.	1996/2000	
7.5L	MOTOR	MODELOS	DESDE / A	
	ENGINE	MODELS	FROM / TO	
CA-165-T	V8 OHV 16V 455" VIN R	OLDSMOBILE DELTA, CUTLASS, VISTA.	1968/1974	
8.1L	MOTOR	MODELOS	DESDE / A	
	ENGINE	MODELS	FROM / TO	
CA-181-G	V8 OHV 16V	SILVERADO, 2500HD, 3500, SIERRA 2500, 3500, YUKON, SUBURBAN, AVALANCHE, EXPRESS VAN.	2001/2007	



1.3L	MOTOR	MODELOS	DESDE / A	
	ENGINE	MODELS	FROM / TO	
CA-1450-G	4L SOHC 8V D13A1 D13A2 EV1 EV2	CIVIC.	1984/1987	
1.5L	MOTOR	MODELOS	DESDE / A	
	ENGINE	MODELS	FROM / TO	
CA-1450-G	4L SOHC 12V D15A3 EW3 EW4	CIVIC.	1984/1991	
1.5L	MOTOR	MODELOS	DESDE / A	
	ENGINE	MODELS	FROM / TO	
CA-1452-G	4L SOHC 16V D15B7, D15B8.	CIVIC (CABEZA DE GRAFITO).	1988/1995	
1.6L	MOTOR	MODELOS	DESDE / A	
	ENGINE	MODELS	FROM / TO	
CA-1454-G	4L DOHC 16V MOTOR VTE-CB181.	CIVIC DEL SOL.	1994/2000	
1.6L	MOTOR	MODELOS	DESDE / A	
	ENGINE	MODELS	FROM / TO	
CA-1455-ML	4L SOHC 16V MOTOR VTEC D16Y5, D16Y7, D16Y8.	CIVIC , ACURA EL (CABEZA DE MLS).	1996/2000	
1.6L	MOTOR	MODELOS	DESDE / A	
	ENGINE	MODELS	FROM / TO	
CA-1455-G	4L SOHC 16V D16B5 D16Y7 D16Y8 D16Z6	CIVIC. ACURA EL (CABEZA DE GRAFITO).	1996/2000	
1.7L	MOTOR	MODELOS	DESDE / A	
	ENGINE	MODELS	FROM / TO	
CA-1459-G	4L SOHC 16V D17A1, A2, A6, A7.	CIVIC, ACURA EL.	2001/2005	
1.7L	MOTOR	MODELOS	DESDE / A	
	ENGINE	MODELS	FROM / TO	
CA-1459-ML	4L SOHC 16V D17A1, A2, A6, A7.	CIVIC, ACURA EL.	2001/2005	



1.8L	MOTOR	MODELOS	DESDE / A	
	ENGINE	MODELS	FROM / TO	
CA-1454-G	1994/2001 4L DOHC 16V MOTOR VTECB18C1.	ACURA INTEGRA.	1994/2001	
1.8L	MOTOR	MODELOS	DESDE / A	
	ENGINE	MODELS	FROM / TO	
CA-1480-ML	4L SOHC 16V MOTOR i-VTE-CR18A1, A4.	CIVIC EX, DX, LXS.	2006/2009	
2.0L	MOTOR	MODELOS	DESDE / A	
	ENGINE	MODELS	FROM / TO	
CA-1453-G	4L SOHC 12V A20A1, A20A2, A20A3.	ACCORD, PRELUDE.	1985/1989	
2.0L	MOTOR	MODELOS	DESDE / A	
	ENGINE	MODELS	FROM / TO	
CA-1461-ML	4L DOHC 16V B20B4, B20Z2.	CR-V.	1997/2001	
2.2L	MOTOR	MODELOS	DESDE / A	
	ENGINE	MODELS	FROM / TO	
CA-1457-ML	4L SOHC 16V F22A4, F22A6, F22A1.	ACCORD.	1990/1991	
2.2L	MOTOR	MODELOS	DESDE / A	
	ENGINE	MODELS	FROM / TO	
CA-1457-G	4L SOHC 16V F22A4, F22A6, F22A1.	ACCORD, PRELUDE.	1990/1997	
2.3L	MOTOR	MODELOS	DESDE / A	
	ENGINE	MODELS	FROM / TO	
CA-1463-ML	4L SOHC 16V MOTOR VTEC-F23A1, A4, A5, A7.	ACCORD, ODYSSEY, ACURA CL.	1998/2002	
2.3L	MOTOR	MODELOS	DESDE / A	
	ENGINE	MODELS	FROM / TO	
CA-1473-ML	4L DOHC 16V H23A1	PRELUDE.	1992/1996	



2.4L	MOTOR	MODELOS	DESDE / A			
	ENGINE	MODELS	FROM / TO			
CA-1466-ML	4L DOHC 16V K24A1	CR-V.	2002/2006			
2.4L	MOTOR	MODELOS	DESDE / A			
	ENGINE	MODELS	FROM / TO			
CA-1469-ML	4L DOHC 16V i-VTEC K24Z1, K24A8, K24Z6.	CR-V, ACCORD, ELEMENT, ACURA TSX.	2004/2010			
2.7L	MOTOR	MODELOS	DESDE / A			
	ENGINE	MODELS	FROM / TO			
CA-1465-G	V6 SOHC 24V MOTOR C27A4.	ACCORD.	1995/1997			
3.0L	MOTOR	MODELOS	DESDE / A			
	ENGINE	MODELS	FROM / TO			
CA-1467-ML	V6 SOHC 24V MOTOR VTEC-J30A1.	ACCORD , ACURA CL.	1997/2002			
3.2L	MOTOR	MODELOS	DESDE / A			
	ENGINE	MODELS	FROM / TO			
CA-1470-G	V6 SOHC 24V MOTOR VTE-C32A1, A6.	ACURA LEGEND, TL.	1991/1998			
3.2L	MOTOR	MODELOS	DESDE / A			
	ENGINE	MODELS	FROM / TO			
CA-1471-ML	V6 SOHC 24V MOTOR VTEC-J32A1.	ACURA CL, TL.	1999/2003			
3.2L	MOTOR	MODELOS	DESDE / A			
	ENGINE	MODELS	FROM / TO			
CA-1471-1ML	V6 SOHC 24V	ACURA TL.	2004/2008			
3.5L	MOTOR	MODELOS	DESDE / A			
	ENGINE	MODELS	FROM / TO			
CA-1470-G	V6 SOHC 24V MOTOR VTE-C35A1.	ACURA RL. (IZQUIERDA)	1996/2004			



3.5L	MOTOR	MODELOS	DESDE / A	
	ENGINE	MODELS	FROM / TO	
CA-1470-1G	V6 SOHC 24V MOTOR VTE-C35A1.	ACURA RL. (DERECHA)	1996/2004	
3.5L	MOTOR	MODELOS	DESDE / A	
	ENGINE	MODELS	FROM / TO	
CA-1471-ML	V6 SOHC 24V	ODYSSEY, PILOT, ACURA MDX.	1999/2004	
3.5L	MOTOR	MODELOS	DESDE / A	
	ENGINE	MODELS	FROM / TO	
CA-1471-1ML	V6 SOHC 24V MOTOR VTEC-J35A6, A7, A9, Z1.	PILOT, ODYSSEY, RIDGELINE, ACURA MDX, SATURN VUE.	2003/2010	
3.5L	MOTOR	MODELOS	DESDE / A	
	ENGINE	MODELS	FROM / TO	
CA-1476-ML	V6 SOHC 24V MOTOR J35Z2, Z3, Z4, Z5.	ACCORD, ACCORD CROSSTOUR, PILOT, RIDGELINE, ODYSSEY, ACURA RDX, TSX, TL. (DERECHA)	2008/2013	
3.5L	MOTOR	MODELOS	DESDE / A	
	ENGINE	MODELS	FROM / TO	
CA-1476-1ML	V6 SOHC 24V MOTOR J35Z2, Z3, Z4, Z5.	ACCORD, ACCORD CROSSTOUR, PILOT, RIDGELINE, ODYSSEY, ACURA RDX, TSX, TL. (IZQUIERDA)	2008/2013	



2.6L	MOTOR	MODELOS	DESDE / A		
	ENGINE	MODELS	FROM / TO		
CA-1720-G	4L SOHC 8V 4ZE1 VIN E.	RODEO, TROOPER, AMIGO.	1988/1997		
3.2L	MOTOR	MODELOS	DESDE / A		
	ENGINE	MODELS	FROM / TO		
CA-1750-G	V6 SOHC 24V VIN V	RODEO, TROOPER, HONDA PASSPORT.	1992/1995		
3.2L	MOTOR	MODELOS	DESDE / A		
	ENGINE	MODELS	FROM / TO		
CA-1752-ML	V6 SOHC 32V 6VD1	RODEO, AMIGO, TROOPER, AXIOM, VehiCROSS, HONDA PASSPORT. (IZQUIERDA)	1998/2003		
3.2L	MOTOR	MODELOS	DESDE / A		
	ENGINE	MODELS	FROM / TO		
CA-1752-1ML	V6 SOHC 32V 6VD1	RODEO, AMIGO, TROOPER, AXIOM, VehiCROSS, HONDA PASSPORT. (DERECHA)	1998/2003		
3.5L	MOTOR	MODELOS	DESDE / A		
	ENGINE	MODELS	FROM / TO		
CA-1752-1ML	V6 SOHC 32V 6VE1	RODEO, AMIGO, TROOPER, AXIOM, VehiCROSS, HONDA PASSPORT. (DERECHA)	1998/2003		
3.5L	MOTOR	MODELOS	DESDE / A		
	ENGINE	MODELS	FROM / TO		
CA-1752-ML	V6 SOHC 32V 6VE1	RODEO, AMIGO, TROOPER, AXIOM, VehiCROSS, HONDA PASSPORT. (IZQUIERDA)	1998/2003		



1.6L	MOTOR	MODELOS	DESDE / A	
	ENGINE	MODELS	FROM / TO	
CA-324-ML	4L DOHC 16V Z6	MAZDA 3.	2006/2007	
1.6L	MOTOR	MODELOS	DESDE / A	
	ENGINE	MODELS	FROM / TO	
CA-1107-G	4L SOHC 8V y DOHC 16V TURBOCARGADO	MIATA, CAPRI, 323, MX-5.	1988/1994	
1.8L	MOTOR	MODELOS	DESDE / A	
	ENGINE	MODELS	FROM / TO	
CA-1111-2ML	4L DOHC 16V	MIATA.	2001/2005	
2.0L	MOTOR	MODELOS	DESDE / A	
	ENGINE	MODELS	FROM / TO	
CA-1110-G	4L SOHC 8V MOTOR "FE" y "F8"	PICK UP B2000, 626.	1983/1987	
2.0L	MOTOR	MODELOS	DESDE / A	
	ENGINE	MODELS	FROM / TO	
CA-1112-ML	4L DOHC 16V	626 , PROTEGE, PROBE, MX-6.	1993/1997	
2.2L	MOTOR	MODELOS	DESDE / A	
	ENGINE	MODELS	FROM / TO	
CA-1120-G	4L SOHC 12V MOTOR F2	626, MX-6, FORD PROBE.	1988/1992	
2.5L	MOTOR	MODELOS	DESDE / A	
	ENGINE	MODELS	FROM / TO	
CA-328-1ML	V6 DOHC 24V DURATEC VIN G,L	COUGAR, MAZDA MPV. (IZQUIERDA)	2001/2002	
2.5L	MOTOR	MODELOS	DESDE / A	
	ENGINE	MODELS	FROM / TO	
CA-328-ML	V6 DOHC 24V DURATEC VIN G,L	COUGAR, MAZDA MPV. (DERECHA)	2001/2002	



2.6L	MOTOR	MODELOS	DESDE / A
	ENGINE	MODELS	FROM / TO
CA-1125-G	4L SOHC 12V MOTOR G6	PICK-UP B2600 , MPV.	1989/1994











3.0L	MOTOR	MODELOS	DESDE / A
	ENGINE	MODELS	FROM / TO
CA-1130-ML	V6 DOHC 24V	929, MPV. (DERECHO)	1989/1998



3.0L	MOTOR	MODELOS	DESDE / A
	ENGINE	MODELS	FROM / TO
CA-1131-ML	V6 DOHC 24V	929, MPV. (IZQUIERDO).	1989/1998





1.2L	MOTOR	MODELOS	DESDE / A	
	ENGINE	MODELS	FROM / TO	
CA-1213-G	4L OHV 8V MOTOR A12	AUTOS AMERICANOS.	1980/1982	
1.4L	MOTOR	MODELOS	DESDE / A	
	ENGINE	MODELS	FROM / TO	
CA-1213-G	4L OHV 8V MOTOR A14	AUTOS AMERICANOS.	1979/1982	
1.5L	MOTOR	MODELOS	DESDE / A	
	ENGINE	MODELS	FROM / TO	
CA-1213-G	4L OHV 8V MOTOR A15	AUTOS AMERICANOS.	1979/1982	
1.5L	MOTOR	MODELOS	DESDE / A	
	ENGINE	MODELS	FROM / TO	
CA-1216-G	4L SOHC 8V E15	TSURU I.	1984/1987	
1.6L	MOTOR	MODELOS	DESDE / A	
	ENGINE	MODELS	FROM / TO	
CA-1216-G	4L SOHC 8V E16	TSURU II.	1987/1991	
1.6L	MOTOR	MODELOS	DESDE / A	
	ENGINE	MODELS	FROM / TO	
CA-1226-G	4L DOHC 16V GA16DE MOTOR JAPONES	200S SX, SENTRA , TSURU GS1, TSUBAME, LUCINO.	1991/1996	
1.6L	MOTOR	MODELOS	DESDE / A	
	ENGINE	MODELS	FROM / TO	
CA-1226-1G	4L DOHC 16V GA16DE GA16DNE	TSURU GSI, GSII, SENTRA MEXICO, TSUBAME.	1997/2014	
1.6L	MOTOR	MODELOS	DESDE / A	
	ENGINE	MODELS	FROM / TO	
CA-1227-G	4L SOHC 12 V MOTOR GA16I	SENTRA AMERICANO, PULSAR NX.	1989/1990	



1.6L	MOTOR	MODELOS	DESDE / A	
	ENGINE	MODELS	FROM / TO	
CA-1242-2ML	4L DOHC 16 V 98" HR16DE	MARCH, VERSA.	2012/2014	
1.6L	MOTOR	MODELOS	DESDE / A	
	ENGINE	MODELS	FROM / TO	
CA-1550-ML	4L DOHC 16V K4M-690	PLATINA, CLIO, KANGOO CABEZA DE MLS).	2002/2009	
1.6L	MOTOR	MODELOS	DESDE / A	
	ENGINE	MODELS	FROM / TO	
CA-1550-G	4L DOHC 16V K4M-690	PLATINA, CLIO, KANGOO, (CABEZA DE GRAFITO).	2002/2009	
1.8L	MOTOR	MODELOS	DESDE / A	
	ENGINE	MODELS	FROM / TO	
CA-1214-G	4L OHV 8V MOTOR CA18ET	200SX, STANZA.	1982/1988	
1.8L	MOTOR	MODELOS	DESDE / A	
	ENGINE	MODELS	FROM / TO	
CA-1234-ML	4L DOHC 16V QG18DE	SENTRA (CABEZA DE MLS).	2000/2003	
1.8L	MOTOR	MODELOS	DESDE / A	
	ENGINE	MODELS	FROM / TO	
CA-1234-G	4L DOHC 16V QG18DE	SENTRA, (CABEZA DE GRAFITO).	2000/2003	
1.8L	MOTOR	MODELOS	DESDE / A	
	ENGINE	MODELS	FROM / TO	
CA-1238-G	4L DOHC 16V MR18DE	TIIDA, SENTRA, VERSA.	2007/2011	
1.8L	MOTOR	MODELOS	DESDE / A	
	ENGINE	MODELS	FROM / TO	
CA-1238-ML	4L DOHC 16V MR18DE	TIIDA, SENTRA, VERSA.	2007/2011	



2.0L	MOTOR	MODELOS	DESDE / A	
	ENGINE	MODELS	FROM / TO	
CA-1214-G	4L OHV 8V MOTOR CA20E TURBOCARGADO	200SX, STANZA.	1982/1988	
2.0L	MOTOR	MODELOS	DESDE / A	
	ENGINE	MODELS	FROM / TO	
CA-1218-G	4L SOHC 8 VALV MOTOR L20B	200SX, PICK UP 720, 710, 620, 510.	1977/1980	
2.0L	MOTOR	MODELOS	DESDE / A	
	ENGINE	MODELS	FROM / TO	
CA-1222-G	4L SOHC 8V Z20E	200SX, PICK UP, 510.	1980/1981	
2.0L	MOTOR	MODELOS	DESDE / A	
	ENGINE	MODELS	FROM / TO	
CA-1228-G	4L DOHC 16V 122" SR20DE	200SX, LUCINO, SENTRA, TSURU 2000 GSR.	1992/2000	
2.0L	MOTOR	MODELOS	DESDE / A	
	ENGINE	MODELS	FROM / TO	
CA-1238-ML	4L DOHC 16V MR20DE	SENTRA.	2007/2011	
2.4L	MOTOR	MODELOS	DESDE / A	
	ENGINE	MODELS	FROM / TO	
CA-1224-G	4L SOHC 8V Z24I Z24S	CAMIONETAS VAN, PICK-UP 720, D21.	1983/1989	
2.4L	MOTOR	MODELOS	DESDE / A	
	ENGINE	MODELS	FROM / TO	
CA-1225-G	4L SOHC 12V KA24E KA24S	ICHI VAN, PICK-UP D21, ESTA-QUITAS.	1989/1993	
2.4L	MOTOR	MODELOS	DESDE / A	
	ENGINE	MODELS	FROM / TO	
CA-1232-G	4L DOHC 16V MOTOR KA24DE	FRONTIER, PICK UP, URVAN.	2000/2006	



2.4L	MOTOR	MODELOS	DESDE / A	
	ENGINE	MODELS	FROM / TO	
CA-1233-G	4L DOHC 16V MOTOR KA24DE	SOLO AUTOS ALTIMA.	1993/1999	
2.5L	MOTOR	MODELOS	DESDE / A	
	ENGINE	MODELS	FROM / TO	
CA-1235-G	4L DOHC 16 V QR25DE	X-TRAIL, ALTIMA, SENTRA (CABEZA DE GRAFITO).	2002/2006	
2.5L	MOTOR	MODELOS	DESDE / A	
	ENGINE	MODELS	FROM / TO	
CA-1235-ML	4L DOHC 16V "QR25DE"	X-TRAIL, ALTIMA, SENTRA (CABEZA DE MLS).	2002/2006	
2.5L	MOTOR	MODELOS	DESDE / A	
	ENGINE	MODELS	FROM / TO	
CA-1245-G	4L DOHC 16V QR25DE	ALTIMA, SENTRA, URVAN, FRONTIER, ROGUE (CABEZA DE GRAFITO).	2007/2009	
2.5L	MOTOR	MODELOS	DESDE / A	
	ENGINE	MODELS	FROM / TO	
CA-1245-ML	4L DOHC 16V "QR25DE"	ALTIMA, SENTRA, URVAN, FRONTIER, ROGUE (CABEZA DE MLS).	2007/2009	
2.5L	MOTOR	MODELOS	DESDE / A	
	ENGINE	MODELS	FROM / TO	
CA-1255-ML	4L DOHC 16V QR25DE	URVAN, FRONTIER, EQUATOR (CABEZA DE MLS).	2005/2012	
2.5L	MOTOR	MODELOS	DESDE / A	
	ENGINE	MODELS	FROM / TO	
CA-1255-G	4L DOHC 16V QR25DE	URVAN, FRONTIER, EQUATOR (CABEZA DE GRAFITO).	2005/2012	
2.8L	MOTOR	MODELOS	DESDE / A	
	ENGINE	MODELS	FROM / TO	
CA-1221-B	L6 SOHC 16V L28 L28ET	280ZX,	1981/1983	



3.0L	MOTOR	MODELOS	DESDE / A	
	ENGINE	MODELS	FROM / TO	
CA-1229-G	V6 SOHC 12V VG30 VG30E	FRONTIER, QUEST, X TERRA, MERCURY VILLAGER.	1986/1999	
3.0L	MOTOR	MODELOS	DESDE / A	
	ENGINE	MODELS	FROM / TO	
CA-1237-1ML	V6 DOHC 24V VQ30DE	MAXIMA, INFINITI I30.	2000/2001	
3.0L	MOTOR	MODELOS	DESDE / A	
	ENGINE	MODELS	FROM / TO	
CA-1243-ML	4L DOHC 16V, TDI ZD30DDTI	URVAN TURBODIESEL.	2001/2009	
3.0L	MOTOR	MODELOS	DESDE / A	
	ENGINE	MODELS	FROM / TO	
CA-1244-ML	V6 DOHC 24V VQ30DE VIN C	MAXIMA, INFINITI I30.	1995/1999	
3.3L	MOTOR	MODELOS	DESDE / A	
	ENGINE	MODELS	FROM / TO	
CA-1229-1G	V6 SOHC 12V VG33DE	PATHFINDER, FRONTIER, X-TERRA.	1996/2004	
3.5L	MOTOR	MODELOS	DESDE / A	
	ENGINE	MODELS	FROM / TO	
CA-1236-ML	V6 DOHC 24V VQ35DE	MAXIMA, ALTIMA, MURANO, QUEST, 350Z, INFINITI G35, I35. (IZQUIERDA)	2002/2008	
3.5L	MOTOR	MODELOS	DESDE / A	
	ENGINE	MODELS	FROM / TO	
CA-1236-1ML	V6 DOHC 24V VQ35DE	MAXIMA, ALTIMA, MURANO, QUEST, 350Z, INFINITI G35, I35. (DERECHA)	2002/2008	
3.5L	MOTOR	MODELOS	DESDE / A	
	ENGINE	MODELS	FROM / TO	
CA-1239-ML	V6 DOHC 24V VQ35DE	PATHFINDER, INFINITI, QX4, FX35. (IZQUIERDA)	2001/2004	



3.5L	MOTOR	MODELOS	DESDE / A
	ENGINE	MODELS	FROM / TO
CA-1239-1ML	V6 DOHC 24V VQ35DE	PATHFINDER, INFINITI, QX4, FX35. (DERECHA)	2001/2004



5.6L	MOTOR	MODELOS	DESDE / A
	ENGINE	MODELS	FROM / TO
CA-1256-G	V8 DOHC 32V VK56DE	ARMADA, TITAN, PATHFINDER (CABEZA DE GRAFITO). (DERECHA)	2004/2010



5.6L	MOTOR	MODELOS	DESDE / A
	ENGINE	MODELS	FROM / TO
CA-1256-1G	V8 DOHC 32V VK56DE	TITAN, ARMADA, PATHFINDER (CABEZA DE GRAFITO). (IZQUIERDA)	2004/2010



RENAULT ■

1.6L	MOTOR	MODELOS	DESDE / A
	ENGINE	MODELS	FROM / TO
CA-1530-G	4L OHV	R12, R18, TS.	1975/1984

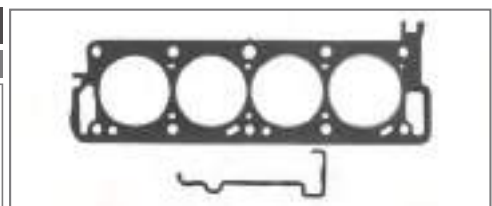



1.5L	MOTOR	MODELOS	DESDE / A	
	ENGINE	MODELS	FROM / TO	
CA-1304-G	4L SOHC 12V 3EE VIN E.	TERCEL.	1987/1994	
1.5L	MOTOR	MODELOS	DESDE / A	
	ENGINE	MODELS	FROM / TO	
CA-1305-ML	4L DOHC 16V.	TERCEL, PASEO.	1992/1995	
1.5L	MOTOR	MODELOS	DESDE / A	
	ENGINE	MODELS	FROM / TO	
CA-1305-1G	4L DOHC 16V.	TERCEL, PASEO.	1995/1999	
1.6L	MOTOR	MODELOS	DESDE / A	
	ENGINE	MODELS	FROM / TO	
CA-1301-B	4L OHV 8V.	COROLLA, CARINA.	1977/1979	
1.6L	MOTOR	MODELOS	DESDE / A	
	ENGINE	MODELS	FROM / TO	
CA-1307-G	4L DOHC 16V MOTOR 4AFE.	COROLLA , PRIZM.	1993/1997	
1.8L	MOTOR	MODELOS	DESDE / A	
	ENGINE	MODELS	FROM / TO	
CA-1307-ML	4L DOHC 16V 7AFE.	COROLLA , CELICA, GEO PRIZM.	1993/1997	
1.9L	MOTOR	MODELOS	DESDE / A	
	ENGINE	MODELS	FROM / TO	
CA-1300-B	4L OHV 8V	CELICA,CORONA,PICK-UP.	1968/1974	
1.8L	MOTOR	MODELOS	DESDE / A	
	ENGINE	MODELS	FROM / TO	
CA-1302-ML	4L DOHC 16V MOTOR 1ZZFE.	CELICA , COROLLA, MR2, MATRIX, PONTIAC VIBE, PRIZM.	1998/2009	



2.0L	MOTOR	MODELOS	DESDE / A	
	ENGINE	MODELS	FROM / TO	
CA-1321-G	4L SOHC 8V 2SELC.	CELICA, CAMRY.	1983/1986	
2.0L	MOTOR	MODELOS	DESDE / A	
	ENGINE	MODELS	FROM / TO	
CA-1323-G	4L SOHC 8V MOTOR 3YEC,	VAN CARGA.	1984/1985	
2.0L	MOTOR	MODELOS	DESDE / A	
	ENGINE	MODELS	FROM / TO	
CA-1324-G	4L DOHC 16V 5SFE, 3SFE.	CAMRY, CELICA, MR2.	1987/1995	
2.0L	MOTOR	MODELOS	DESDE / A	
	ENGINE	MODELS	FROM / TO	
CA-1322-G	4L DOHC 16V 5SFE, 3SFE.	CAMRY, CELICA, MR2.	1987/1995	
2.0L	MOTOR	MODELOS	DESDE / A	
	ENGINE	MODELS	FROM / TO	
CA-1325-ML	4L DOHC 16V MOTOR1AZFE	RAV4.	2001/2003	
2.2L	MOTOR	MODELOS	DESDE / A	
	ENGINE	MODELS	FROM / TO	
CA-1310-G	4L SOHC 8V 20R	CELICA, CORONA PICK-UP.	1975/1980	
2.2L	MOTOR	MODELOS	DESDE / A	
	ENGINE	MODELS	FROM / TO	
CA-1322-ML	4L DOHC 16V MOTOR 3SGTE TURBO.	MR2 TURBO.	1991	
2.2L	MOTOR	MODELOS	DESDE / A	
	ENGINE	MODELS	FROM / TO	
CA-1322-G	4L DOHC 16V 5SFE, 3SFE.	CAMRY, CELICA, MR2.	1987/1995	



2.2L	MOTOR	MODELOS	DESDE / A	
	ENGINE	MODELS	FROM / TO	
CA-1324-G	4L DOHC 16V 5SFE, 3SFE.	CAMRY, CELICA, MR2.	1987/1995	
2.4L	MOTOR	MODELOS	DESDE / A	
	ENGINE	MODELS	FROM / TO	
CA-1327-G	4L DOHC 16V 2TZFE, 2TZFZE.	PREVIA.	1991/1997	
2.4L	MOTOR	MODELOS	DESDE / A	
	ENGINE	MODELS	FROM / TO	
CA-1328-ML	4L DOHC 16V.	RAV4, CAMRY, HIGHLANDER.	2002/2007	
2.4L	MOTOR	MODELOS	DESDE / A	
	ENGINE	MODELS	FROM / TO	
CA-1330-G	4L DOHC 2RZFE	TACOMA.	1994/2004	
2.7L	MOTOR	MODELOS	DESDE / A	
	ENGINE	MODELS	FROM / TO	
CA-1352-G	4L DOHC 16V 3RZFE.	TACOMA, T-100, 4RUNNER.	1994/2004	
2.7L	MOTOR	MODELOS	DESDE / A	
	ENGINE	MODELS	FROM / TO	
CA-1354-ML	4L DOHC 16V 1ARFE, 2TRFE.	HIACE, HILUX, VENZA,	2005/2010	
3.0L	MOTOR	MODELOS	DESDE / A	
	ENGINE	MODELS	FROM / TO	
CA-1350-G	V6 SOHC 12V 3VZE.	4RUNNER, PICK-UP, T100.	1988/1995	
3.0L	MOTOR	MODELOS	DESDE / A	
	ENGINE	MODELS	FROM / TO	
CA-1351-G	V6 SOHC 12V 3VZE.	4RUNNER, PICK-UP, T100.	1988/1995	



3.0L	MOTOR	MODELOS	DESDE / A	
	ENGINE	MODELS	FROM / TO	
CA-1353-G	6L DOHC 24V 2JZGE VIN "J"	SUPRA, LEXUS SC300, IS300, GS300.	1993/1998	
3.0L	MOTOR	MODELOS	DESDE / A	
	ENGINE	MODELS	FROM / TO	
CA-1353-ML	DOHC 24v 2JZGE.	SUPRA, LEXUS, GS300, IS300, SC300	1992/2005	
3.0L	MOTOR	MODELOS	DESDE / A	
	ENGINE	MODELS	FROM / TO	
CA-1355-G	V6 DOHC 24V 3VZFE.	CAMRY, LEXUS ES300. (IZQUIERDA)	1992/1993	
3.0L	MOTOR	MODELOS	DESDE / A	
	ENGINE	MODELS	FROM / TO	
CA-1355-1G	V6 DOHC 24V 3VZFE.	CAMRY, LEXUS ES300. (DERECHA)	1992/1993	
3.0L	MOTOR	MODELOS	DESDE / A	
	ENGINE	MODELS	FROM / TO	
CA-1356-G	V6 DOHC 24V 1MZFE	CAMRY, AVALON, SIENNA, SOLARA.	1994/2000	
3.0L	MOTOR	MODELOS	DESDE / A	
	ENGINE	MODELS	FROM / TO	
CA-1356-1G	V6 DOHC 24V 1MZFE	CAMRY, AVALON, SIENNA, SOLARA.	1994/2000	
3.0L	MOTOR	MODELOS	DESDE / A	
	ENGINE	MODELS	FROM / TO	
CA-1356-ML	V6 DOHC 24V 1MZFE	CAMRY, AVALON, SIENNA, SOLARA. (DERECHA)	1994/2000	
3.0L	MOTOR	MODELOS	DESDE / A	
	ENGINE	MODELS	FROM / TO	
CA-1356-1ML	V6 DOHC 24V 1MZFE	CAMRY, AVALON, SIENNA, SOLARA. (IZQUIERDA)	1994/2000	



3.4L	MOTOR	MODELOS	DESDE / A	
	ENGINE	MODELS	FROM / TO	
CA-1357-G	V6 DOHC 24V 5VZFE.	TACOMA, 4RUNNER, T-100, TUNDRA. (IZQUIERDA)	1995/2004	
3.4L	MOTOR	MODELOS	DESDE / A	
	ENGINE	MODELS	FROM / TO	
CA-1358-G	V6 DOHC 24V 5VZFE.	TACOMA, 4RUNNER, T-100, TUNDRA. (DERECHA)	1995/2004	
4.0L	MOTOR	MODELOS	DESDE / A	
	ENGINE	MODELS	FROM / TO	
CA-1361-G	V8 DOHC 32V 1UZFE.	LEXUS LS400, SC400. (IZQUIERDA)	1990/1997	
4.0L	MOTOR	MODELOS	DESDE / A	
	ENGINE	MODELS	FROM / TO	
CA-1361-1G	V8 DOHC 32V 1UZFE.	LEXUS LS400, SC400. (DERECHA)	1990/1997	
4.0L	MOTOR	MODELOS	DESDE / A	
	ENGINE	MODELS	FROM / TO	
CA-1361-1ML	V8 DOHC 32V 1UZFE	LEXUS GS400, LS400, SC400. (IZQUIERDA)	1998/2000	
4.0L	MOTOR	MODELOS	DESDE / A	
	ENGINE	MODELS	FROM / TO	
CA-1361-ML	V8 DOHC 32V 1UZFE	LEXUS GS400, LS400, SC400. (DERECHA)	1998/2000	
4.0L	MOTOR	MODELOS	DESDE / A	
	ENGINE	MODELS	FROM / TO	
CA-1367-G	L6 OHV 12V.	LAND CRUISER.	1988/1992	
4.2L	MOTOR	MODELOS	DESDE / A	
	ENGINE	MODELS	FROM / TO	
CA-1367-G	6L OHV 12V.	LAND CRUISER.	1985/1987	



4.0L	MOTOR	MODELOS	DESDE / A	
	ENGINE	MODELS	FROM / TO	
CA-1365-ML	V6 4.0L DOHC 24V 1GRFE	4RUNNER (DERECHA)	2004/2006	
3.0L	MOTOR	MODELOS	DESDE / A	
	ENGINE	MODELS	FROM / TO	
CA-1365-1ML	V6 4.0L DOHC 24V 1GRFE	4RUNNER (IZQUIERDA)	2004/2006	
3.0L	MOTOR	MODELOS	DESDE / A	
	ENGINE	MODELS	FROM / TO	
CA-1369-ML	V8 5.7I DOHC 32v ENGINE 1URFSE	TUNDRA, LX570, LAND CRUISER, SEQUOIA. (DERECHA)	1992/1993	
3.0L	MOTOR	MODELOS	DESDE / A	
	ENGINE	MODELS	FROM / TO	
CA-1369-1ML	V8 5.7I DOHC 32v ENGINE 1URFSE	TUNDRA, LX570, LAND CRUISER, SEQUOIA. (DERECHA)	2007/2013	





1.2L	MOTOR	MODELOS	DESDE / A	
	ENGINE	MODELS	FROM / TO	
CA-1810-C	H4 8V BOXER	SEDAN.	1963/1965	
1.6L	MOTOR	MODELOS	DESDE / A	
	ENGINE	MODELS	FROM / TO	
CA-1835-G	4L SOHC 8V	LUPO, POLO, CROSSFOX, SPORT VAN, GOL.	2003/2014	
1.6L	MOTOR	MODELOS	DESDE / A	
	ENGINE	MODELS	FROM / TO	
CA-1835-ML	4L SOHC 8V BRASIL	LUPO, POLO, CROSSFOX, (CABEZA MLS).	2005/2012	
1.8L	MOTOR	MODELOS	DESDE / A	
	ENGINE	MODELS	FROM / TO	
CA-1840-G	4L SOHC 8V CARB & FI	JETTA A2, GOLF, CORSAR, CABRIOLET, RABBIT.	1983/1998	
1.8L	MOTOR	MODELOS	DESDE / A	
	ENGINE	MODELS	FROM / TO	
CA-1852-ML	4L DOHC 20V TURBO ADR ANB AFY	PASSAT, BEETLE, SHARAN, JETTA GLI, AUDI A4, A3.	2001/2012	
1.8L	MOTOR	MODELOS	DESDE / A	
	ENGINE	MODELS	FROM / TO	
CA-1852-G	4L DOHC 20V ADR ANB AFY	PASSAT, AUDI A4, GOLF, BEETLE.	1996/2005	
1.9L	MOTOR	MODELOS	DESDE / A	
	ENGINE	MODELS	FROM / TO	
CA-1860-ML	4L SOHC 8V TDI	EUROVAN, TRANSPORTER.	2006/2009	
2.0L	MOTOR	MODELOS	DESDE / A	
	ENGINE	MODELS	FROM / TO	
CA-1845-ML	4L SOHC	JETTA A3, GOLF, CABRIO (CABEZA EN MLS).	1993/1999	



2.0L	MOTOR	MODELOS	DESDE / A	
	ENGINE	MODELS	FROM / TO	
CA-1845-G	4L SOHC 8V ABA	JETTA A3, GOLF, CABRIO.	1993/1999	
2.0L	MOTOR	MODELOS	DESDE / A	
	ENGINE	MODELS	FROM / TO	
CA-1850-G	4L SOHC 8V AEG AVH AZG	JETTA A4, GOLF, BEETLE, IBIZA (CABEZA EN GRAFITO).	2000/2007	
2.0L	MOTOR	MODELOS	DESDE / A	
	ENGINE	MODELS	FROM / TO	
CA-1850-ML1	4L SOHC 8V AEG AVH AZG	JETTA A4, GOLF, BEETLE, IBIZA (CABEZA EN MLS).	2000/2007	
2.0L	MOTOR	MODELOS	DESDE / A	
	ENGINE	MODELS	FROM / TO	
CA-1850-ML	4L SOHC 8V AEG AVH AZG	JETTA A4, GOLF, BEETLE, IBIZA (CABEZA EN MLS).	2000/2007	
2.0L	MOTOR	MODELOS	DESDE / A	
	ENGINE	MODELS	FROM / TO	
CA-1855-ML	4L DOHC 16V TURBO	PASSAT, JETTA GLI.	2010/2013	
2.0L	MOTOR	MODELOS	DESDE / A	
	ENGINE	MODELS	FROM / TO	
CA-1855-1ML	4L DOHC 16V TURBO	AUDI, A3, TT.	2008/2011	
2.5L	MOTOR	MODELOS	DESDE / A	
	ENGINE	MODELS	FROM / TO	
CA-1851-B	5L SOHC 10V	CARGOVAN, EUROVAN.	2001/2004	
2.5L	MOTOR	MODELOS	DESDE / A	
	ENGINE	MODELS	FROM / TO	
CA-1856-ML	5L DOHC 20V CBTA CBUA BGP	BORA, BEETLE.	2005/2010	



2.5L	MOTOR	MODELOS	DESDE / A	
	ENGINE	MODELS	FROM / TO	
CA-1870-ML	5L SOHC 10V TDI AEN AAF ACU	EUROVAN, TRANSPORTER.	2001/2004	

2.8L	MOTOR	MODELOS	DESDE / A	
	ENGINE	MODELS	FROM / TO	
CA-1853-ML	V6 DOHC 30V	PASSAT, AUDI A4, A6.	1997/2001	

2.8L	MOTOR	MODELOS	DESDE / A	
	ENGINE	MODELS	FROM / TO	
CA-1854-G	V6 SOHC 12V AFP	JETTA VR6, TRANSPORTER, SHARAN, GOLF GTI,	1992/2003	

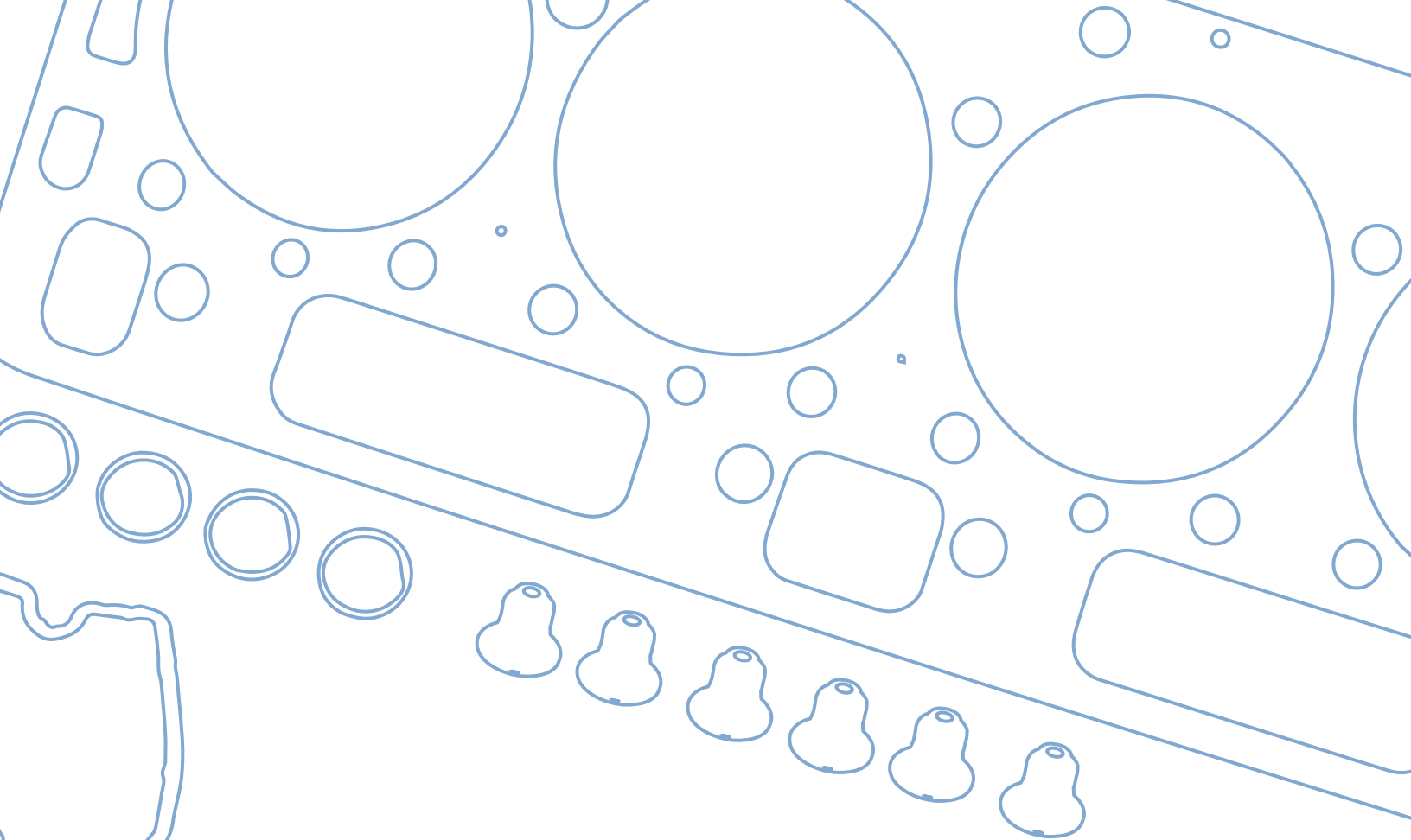

**— ■ JUNTAS EN SOBRE MEDIDA
/ OVER SIZE GASKETS**

**SECCIÓN
/SECTION**

CATÁLOGO DE APLICACIONES / APPLICATION CATALOG

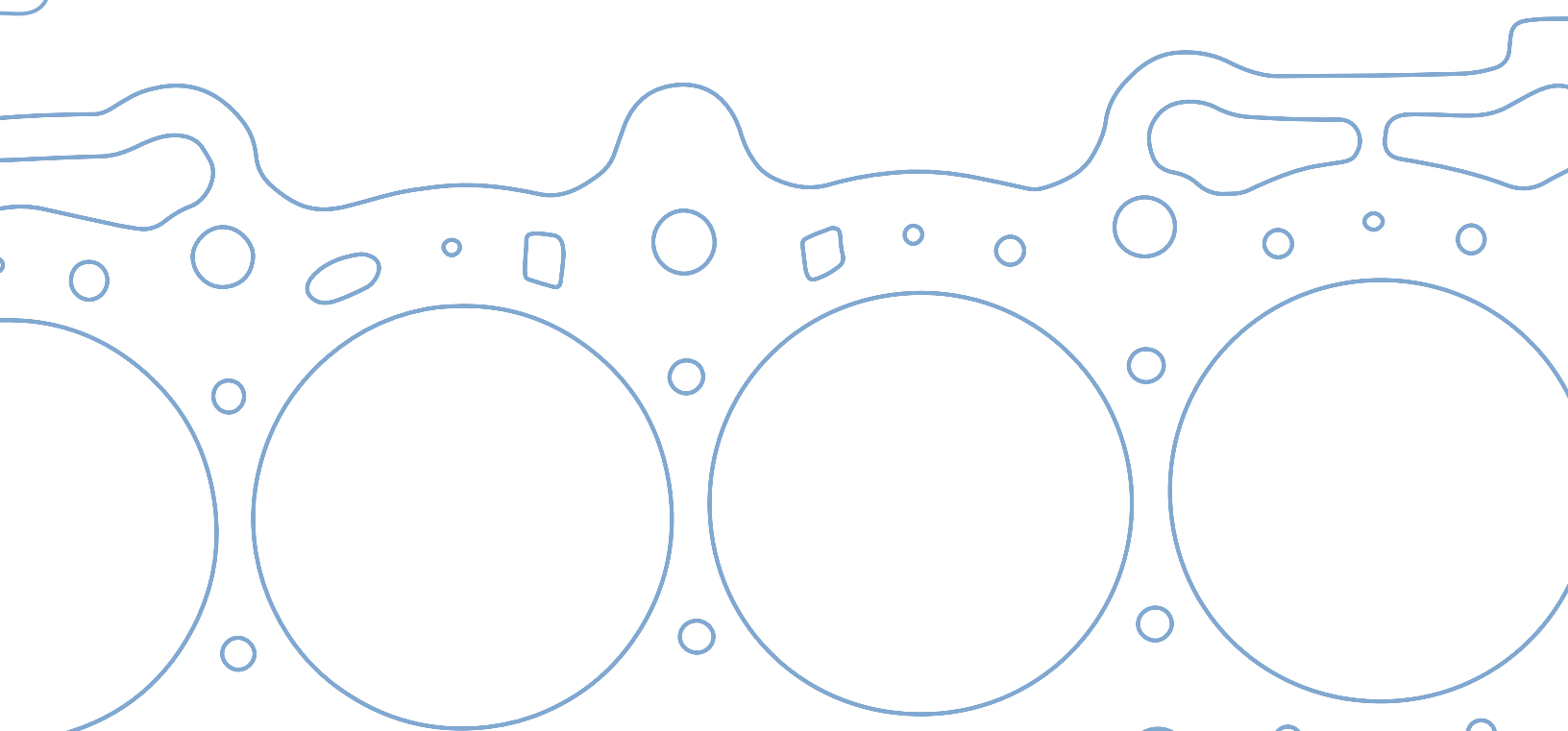









1.5 L	MOTOR	MODELOS	DESDE / A	
	ENGINE	MODELS	FROM / TO	
CA-1452-GX	4L SOHC 16V "D15B1", "D15B6", "D15B12"	HONDA CIVIC MEXICO, (sobremedida+.010").	1997/2001	
1.6 L	MOTOR	MODELOS	DESDE / A	
	ENGINE	MODELS	FROM / TO	
CA-100-1GX	4L SOHC 8V TBI & MPFI	CHEVROLET, CHEVY, CHEVY C2, JOY, MONZA, PICK-UP, (sobremedida+.020")	1996/2010	
1.6 L	MOTOR	MODELOS	DESDE / A	
	ENGINE	MODELS	FROM / TO	
CA-1210-GX	4L OHV 8V MOTOR "J15"; "J16"	DATSUN NISSAN, AUTOS Y CAMIONETAS, (sobremedida+.015").	1970/1983	
1.6 L	MOTOR	MODELOS	DESDE / A	
	ENGINE	MODELS	FROM / TO	
CA-317-GX	4L SOHC 8 V "ZETEC ROCAM"	FORD, FIESTA, IKON, KA, PICK-UP, COURIER, (sobremedida+.010").	2001/2010	
1.6 L	MOTOR	MODELOS	DESDE / A	
	ENGINE	MODELS	FROM / TO	
CA-1455-GX	4L SOHC 16V "B16A2", "B16A3", VTEC	HONDA CIVIC, ACURA, (sobremedida+.010").	1994/2001	
1.6L	MOTOR	MODELOS	DESDE / A	
	ENGINE	MODELS	FROM / TO	
CA-1226-1GX	L4 1.6L 16V DOHC "GA16DE/DNE" MOTOR MEXICO.	TSURU GSI, GSII, SENTRA, (sobremedida+.020").	1995/2010	
1.8 L	MOTOR	MODELOS	DESDE / A	
	ENGINE	MODELS	FROM / TO	
CA-1238-GX	4L DOHC 16 V MR18DE, MR20DE.	NISSAN, TIIDA, SENTRA, (sobremedida+.020").	2007/2011	
2.0 L	MOTOR	MODELOS	DESDE / A	
	ENGINE	MODELS	FROM / TO	
CA-108-XG	4L OHV 8V MOTOR 122", 134".	CHEVROLET CAVALIER, PICK-UP, S10, BLAZER, (sobremedida+.020").	1987/1997	

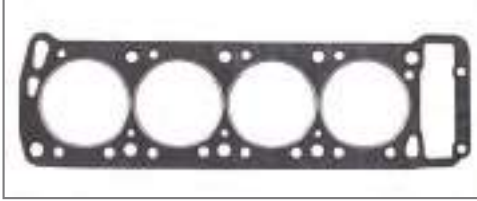

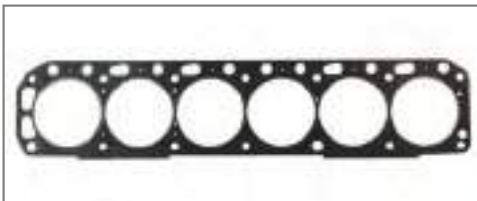
2.0 L	MOTOR	MODELOS	DESDE / A	
	ENGINE	MODELS	FROM / TO	
CA-235-1GX	L4 SOHC, DOHC "G63B", "4G63"	"CHRSYLER, DODGE, MITSUBISHI, COLT, RAM 50, HYUNDAI STELLAR, MITSUBHISH GALANT, (sobremedida+.010")	1983/1998	
2.0 L	MOTOR	MODELOS	DESDE / A	
	ENGINE	MODELS	FROM / TO	
CA-1320-GX	4L SOHC 8V "20R", "22RE", "22RTEC"	TOYOTA, 4RUNNER, CELICA GT, GTS, ST, CORONA, PICKUP, VAN WAGON, (sobremedida+.010")	1980/1995	
2.2 L	MOTOR	MODELOS	DESDE / A	
	ENGINE	MODELS	FROM / TO	
CA-1224-GX	4L SOHC "Z22E" "Z22S"; "Z24I", "Z24S"	NISSAN AUTOS Y CAMIONETAS. (sobremedida+.020")	1981/1989	
2.3 L	MOTOR	MODELOS	DESDE / A	
	ENGINE	MODELS	FROM / TO	
CA-1463-GX	4L SOHC VIN "F22B6"	HONDA ACCORD, ACURA, ODISEY, (sobremedida+.010")	1994/2002	
2.4 L	MOTOR	MODELOS	DESDE / A	
	ENGINE	MODELS	FROM / TO	
CA-1225-GX	4L SOHC 12 V; KA24E, KA24S	NISSAN, ICHI VAN; PICK-UP, ESTAQUITAS, (sobremedida+.020")	1989/2003	
2.4 L	MOTOR	MODELOS	DESDE / A	
	ENGINE	MODELS	FROM / TO	
CA-226-GX	4L DOHC 16V MOTOR "GEMA" VIN "W"	CHRYSLER DODGE, COMPASS, PATRIOT, JOURNEY, AVENGER.	2007/2013	
2.5 L	MOTOR	MODELOS	DESDE / A	
	ENGINE	MODELS	FROM / TO	
CA-1235-GX	4L DOHC 16 V "QR25DE"	NISSAN, ALTIMA, MAXIMA, SENTRA, , X-TRAIL, (sobremedida+.020")	2000/2006	
2.5 L	MOTOR	MODELOS	DESDE / A	
	ENGINE	MODELS	FROM / TO	
CA-1241-GX	4L DOHC 16 V MOTOR YD-25DDTI	NISSAN, CABSTAR, (sobremedida+.020")	2008/2010	



2.5 L	MOTOR	MODELOS	DESDE / A	
	ENGINE	MODELS	FROM / TO	
CA-1245-GX	4L DOHC 16V CODIGO DE MOTOR QR25DE.	NISSAN, ALTIMA, SENTRA, URVAN, ROGUE.	2007/2009	
2.6 L	MOTOR	MODELOS	DESDE / A	
	ENGINE	MODELS	FROM / TO	
CA-250-XG	4L SOHC 8V, VIN 7, E, G, W, G54B	CHRYSLER, MITSUBISHI, MINIVANS, TRUCKS (sobremedida+.020")	1982/1989	
3.0 L	MOTOR	MODELOS	DESDE / A	
	ENGINE	MODELS	FROM / TO	
CA-253-XG	V6 SOHC12V "6G72"	CHRYSLER, DODGE, MITSUBISHI, IMPERIAL, VOYAGER, CARAVAN, (sobremedida+.020")	1987/2000	
4.9 L	MOTOR	MODELOS	DESDE / A	
	ENGINE	MODELS	FROM / TO	
CA-325-XG	L6 OHV 12V 240", 300"	FORD E-150 ECONOLINE, BRONCO, COUNTRY SEDAN, (sobremedida+.010").	1965/1996	
5.4 L	MOTOR	MODELOS	DESDE / A	
	ENGINE	MODELS	FROM / TO	
CA-356-GX	V8 SOHC 16/24V "TRITON"	FORD, LINCOLN, GRAND MARQUIS, F-250, F-350, LOBO. (LADO IZQUIERDO).	1991/2007	
5.4 L	MOTOR	MODELOS	DESDE / A	
	ENGINE	MODELS	FROM / TO	
CA-357-GX	V8 SOHC 16/24V "TRITON"	FORD, LINCOLN, GRAND MARQUIS, F-250, F-350, LOBO; (LADO DERECHO)	1991/2007	
6.5 L	MOTOR	MODELOS	DESDE / A	
	ENGINE	MODELS	FROM / TO	
CA-180-GX	V8 V8 OHV 16V VIN "F" "S" DIESEL	GM CHEVROLET, SUBURBAN, EXPRESS VAN, YUKON, SAVANA 2500, 3500, (sobremedida+.010").	1992/2005	

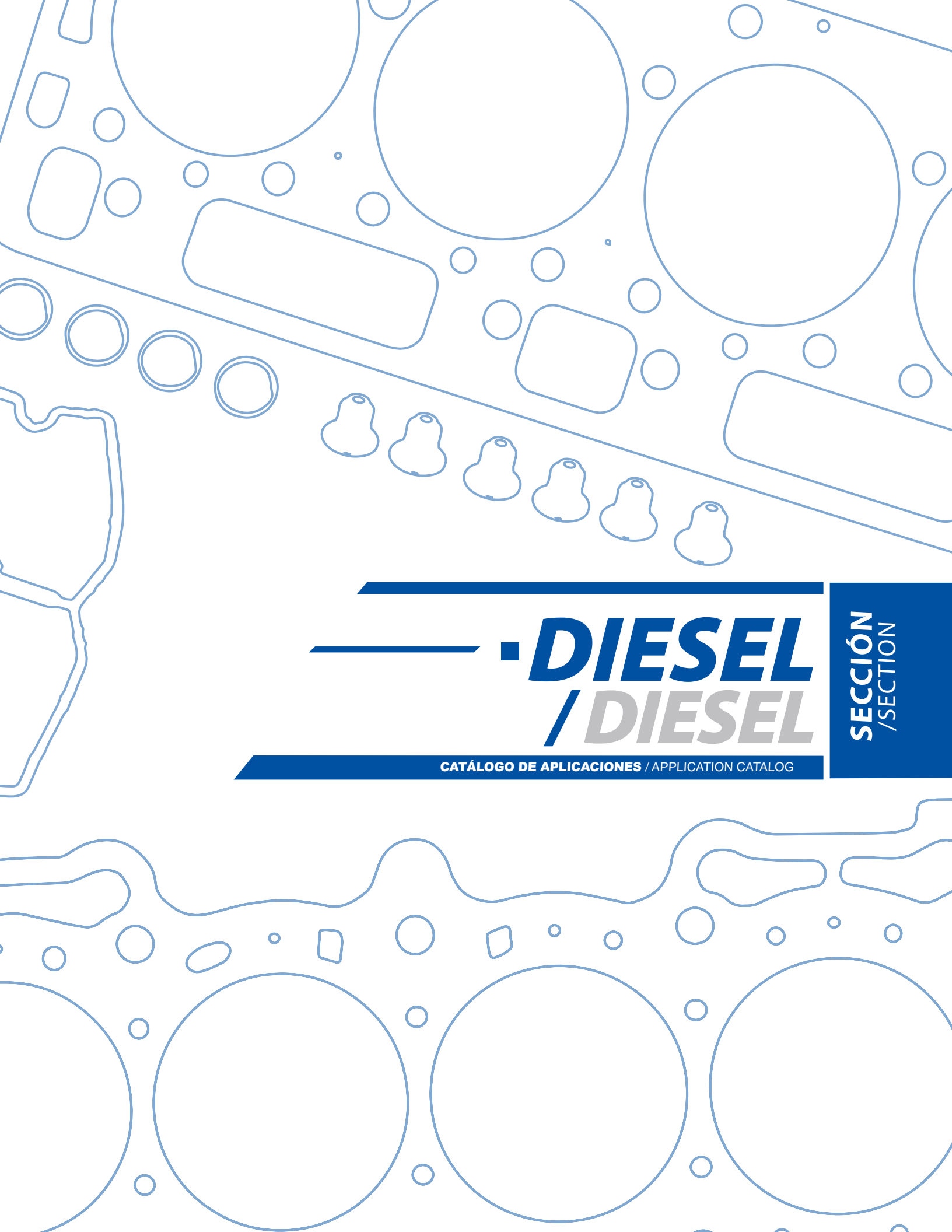

DIESEL **/ DIESEL**

SECCIÓN
/SECTION

CATÁLOGO DE APLICACIONES / APPLICATION CATALOG



DODGE		CA-249-ML	
MOTOR	MODELOS	DESDE / A	
ENGINE	MODELS	FROM / TO	
L6 5.9L OHV 24 V CUMMINS	CAMIONES DIESEL; RAM 2500,RAM 3500	2009/2009	



DODGE		CA-249-B	
MOTOR	MODELOS	DESDE / A	
ENGINE	MODELS	FROM / TO	
L6 5.9L OHV 12 V CUMMINS	CAMIONES DIESEL; RAM 2500,RAM 3500	1984/1993	



FORD		CA-376-G	
MOTOR	MODELOS	DESDE / A	
ENGINE	MODELS	FROM / TO	
V8 7.3L 16V OHV DIESEL VIN F	INTERNATIONAL POWER STROKE VIN "F" E-250,E-350 ECONOLINE F-150 F-250 Y F59	1988/1994	



FORD		CA-396-1G	
MOTOR	MODELOS	DESDE / A	
ENGINE	MODELS	FROM / TO	
V8 7.3L 16V OHV DIESEL VIN F	INTERNATIONAL POWER STROKE VIN "F" E-250,E-350 ECONOLINE F-150 F-250 Y F59	1994/2003	



GM CHEVROLET		CA-179-G	
MOTOR	MODELOS	DESDE / A	
ENGINE	MODELS	FROM / TO	
V8 6.2L 16V OHV DIESEL VIN C, J .	SUBURBAN C1500,C2500,C3500 HEAVY & LIGHT DUTY	1982/1993	



GM CHEVROLET		CA-179-GX	
MOTOR	MODELOS	DESDE / A	
ENGINE	MODELS	FROM / TO	
V8 6.2L 16V OHV DIESEL VIN C, J .	SUBURBAN C1500,C2500,C3500 HEAVY & LIGHT DUTY	1982/1993	



**GM CHEVROLET****CA-180-GD**

MOTOR	MODELOS	DESDE / A
ENGINE	MODELS	FROM / TO
V8 6.5L 16V OHV DIESEL VIN F, P, S, Y, Z,	SUBURBAN, C1500, C2500, C3500 SUBURBAN, EXPRESS 2500, 3500	1994/2005

**GM CHEVROLET****CA-180-GX**

MOTOR	MODELOS	DESDE / A
ENGINE	MODELS	FROM / TO
V8 6.5L 16V OHV DIESEL VIN F, P, S, Y, Z,	SUBURBAN, EXPRESS VAN, YUKON, SAVANA 2500, 3500	1992/2005

**NISSAN****CA-1241-GX**

MOTOR	MODELOS	DESDE / A
ENGINE	MODELS	FROM / TO
4L 2.5L 16V DOHC DIESEL YD-25DDTi	CABSTAR (SOBREMEDIDA 0.60")	2008/2014

**NISSAN****CA-1243-ML**

MOTOR	MODELOS	DESDE / A
ENGINE	MODELS	FROM / TO
4L 3.0L 16V DOHC TURBODIESEL ENGINE ZD30DDTi	NISSAN URVAN (0.028") "OO"	2001/2009

**VOLKSWAGEN****CA-1870-ML**

MOTOR	MODELOS	DESDE / A
ENGINE	MODELS	FROM / TO
5L 2.5L 10V MOTOR AEN, AAF Y ACU.	EUROVAN TRANSPORTER TDI	2001/2004

**VOLKSWAGEN****CA-1860-ML**

MOTOR	MODELOS	DESDE / A
ENGINE	MODELS	FROM / TO
4L 1.9L 8V SOHC TDI	EUROVAN, TRANSPORTER TDI, 0.090" PULG. (2.29 mm)	2006/2009





DODGE, HYUNDAI		FS-206-D
MOTOR	MODELOS	DESDE / A
ENGINE	MODELS	FROM / TO
4L 2.5L 8V SOHC TURBO DIESEL, MOTOR MITSUBISHI "4D56T"	DODGE H-100 (MEXICO)	2005/2009



GM CHEVROLET		FS-179
MOTOR	MODELOS	DESDE / A
ENGINE	MODELS	FROM / TO
V8 6.2L 16V OHV VIN C,X,J (LD/HD)	SUBURBAN ,C1500,C2500,C3500 INCLU- YE VAN 1500,2500,3500	1982/1993



GM CHEVROLET		FS-180
MOTOR	MODELOS	DESDE / A
ENGINE	MODELS	FROM / TO
V8 6.5L/6.2L OHV 16V DIESEL VIN F, P, S, Y, Z.	BLAZER, C1500, C2500, C3500 SUBUR- BAN, EXPRESS 2500, 3500	1994/2005



ISUZU ELF		FS-1780-ML
MOTOR	MODELOS	DESDE / A
ENGINE	MODELS	FROM / TO
4L 3.0L 16V DOHC SERIE 200/300	ISUZU ELF, (4JJ1-TC)138HP	2008/2013



NISSAN		FS-1241-ML
MOTOR	MODELOS	DESDE / A
ENGINE	MODELS	FROM / TO
4L 2.5L 16V DOHC DIESEL YD- 25DDTi	CABSTAR	2008/2014



TOYOTA		FS-1380-ML
MOTOR	MODELOS	DESDE / A
ENGINE	MODELS	FROM / TO
4L 4.0L 16V DIESEL SERIE 300	HINO(CHASIS 514,616,)MEXICO	2009/2014





TOYOTA		FS-1382
MOTOR	MODELOS	DESDE / A
ENGINE	MODELS	FROM / TO
4L 4.7L 16V DIESEL SERIE 500	(CHASIS 1018)(J05D-TG) HINO MEXICO	2009/2014

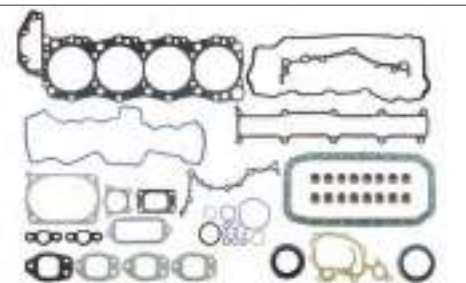

FORD		HS-396-1G
MOTOR	MODELOS	DESDE / A
ENGINE	MODELS	FROM / TO
V8 7.3L 16V OHV DIESEL	TURBO DIESEL SUPER DUTY E-550 ECNOLINE, EXCURSION F-450 SUPER DUTY	1995/2003

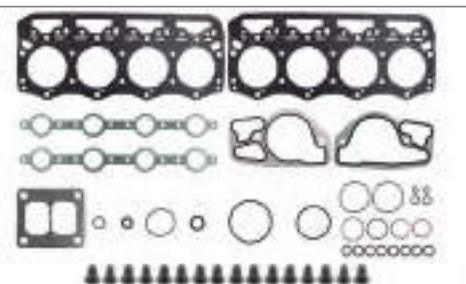

FORD		LS-396
MOTOR	MODELOS	DESDE / A
ENGINE	MODELS	FROM / TO
V8 6.9L/7.3L 16V OHV DIESEL	FORD DIESEL.	1988/1995



FORD		LS-396-1
MOTOR	MODELOS	DESDE / A
ENGINE	MODELS	FROM / TO
V8 7.3L 16V OHV DIESEL VIN F	INTERNATIONAL ENGINE LOWER SET	1994/1995



FORD		LS-396-2
MOTOR	MODELOS	DESDE / A
ENGINE	MODELS	FROM / TO
V8 7.3L 16V OHV DIESEL VIN F	INTERNATIONAL ENGINE LOWER SET	1999/2003



DODGE		VS-3249-R
MOTOR	MODELOS	DESDE / A
ENGINE	MODELS	FROM / TO
L6 5.9L OHV 24 V CUMMINS	CAMIONES DIESEL; RAM 2500, RAM 3500	2003/2011

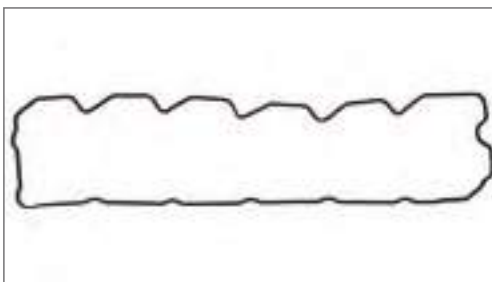



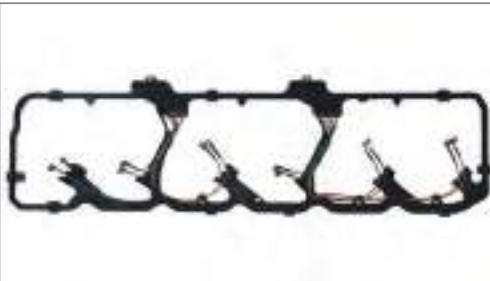

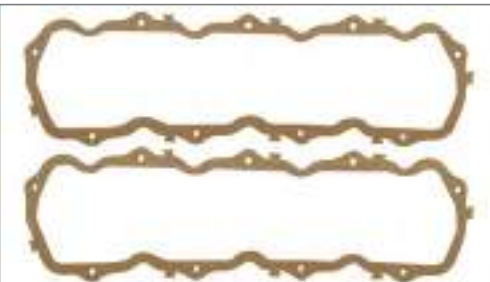
DODGE		VS-3249-NR		
MOTOR	MODELOS	DESDE / A		
ENGINE	MODELS	FROM / TO		
L6 5.9L OHV 24 V CUMMINS	CAMIONES DIESEL; RAM 2500,RAM 3500	2006/2011		

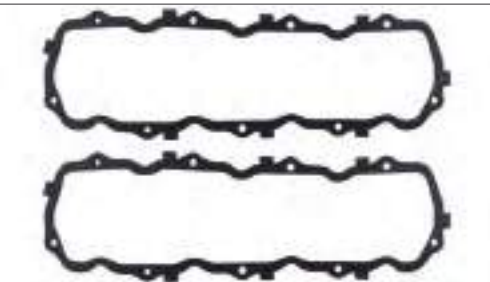
FORD		VS-3396		
MOTOR	MODELOS	DESDE / A		
ENGINE	MODELS	FROM / TO		
V8 6.9L/7.3L 16V OHV DIESEL	FORD DIESEL	1983/1994		

FORD		VS-3396-R		
MOTOR	MODELOS	DESDE / A		
ENGINE	MODELS	FROM / TO		
V8 6.9L/7.3L 16V OHV DIESEL	FORD DIESEL	1983/1994		

FORD		VS-3396-1R		
MOTOR	MODELOS	DESDE / A		
ENGINE	MODELS	FROM / TO		
V8 7.3L 16V OHV DIESEL VIN F	INTERNATIONAL POWER STROKE VIN "F" E-250,E-350 ECONOLINE F-150 F-250.	1994/1997		

FORD		VS-3396-2R		
MOTOR	MODELOS	DESDE / A		
ENGINE	MODELS	FROM / TO		
V8 7.3L 16V OHV DIESEL VIN F	INTERNATIONAL POWER STROKE VIN "F" E-250,E-350 ECONOLINE F-150 F-250.	1998/2003		

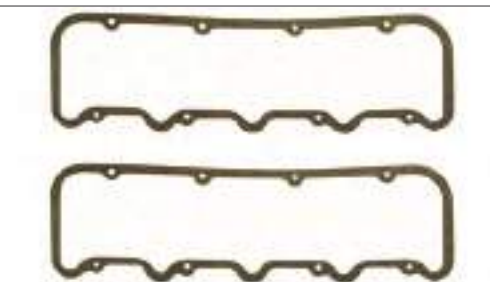
GM CHEVROLET		VS-3180		
MOTOR	MODELOS	DESDE / A		
ENGINE	MODELS	FROM / TO		
V8 6.5L/6.2L OHV 16V DIESEL VIN F, P, S, Y, Z.	SUBURBAN, VAN,C1500,C2500,- C3500,HUMMER	1982/2004		

**FORD****MS-4396-E**

MOTOR	MODELOS	DESDE / A
ENGINE	MODELS	FROM / TO
V8 6.9L/7.3L 16V OHV DIESEL	FORD DIESEL	1983/1994

**FORD****MS-4396-1E**

MOTOR	MODELOS	DESDE / A
ENGINE	MODELS	FROM / TO
V8 7.3L 16V OHV DIESEL VIN F	FORD DIESEL	1994/1999

**FORD****MS-4396-2E**

MOTOR	MODELOS	DESDE / A
ENGINE	MODELS	FROM / TO
V8 7.3L 16V OHV DIESEL VIN F	FORD DIESEL	2001/2003

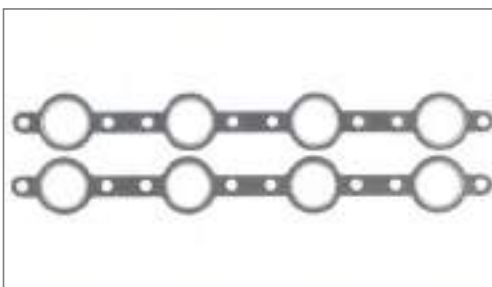
**GM CHEVROLET****MS-4180-1**

MOTOR	MODELOS	DESDE / A
ENGINE	MODELS	FROM / TO
V8 6.5L/6.2L OHV 16V DIESEL VIN J	SUBURBAN C1500, C2500, C3500 LIGHT DUTY	1982/2004

**GM CHEVROLET****MS-4180-AD**

MOTOR	MODELOS	DESDE / A
ENGINE	MODELS	FROM / TO
V8 6.5L/6.2L OHV 16V DIESEL VIN J	SUBURBAN C1500, C2500, C3500 LIGHT DUTY (VENTANA TAPADA)	1982/2004

**GM CHEVROLET****MS-4180-E**

MOTOR	MODELOS	DESDE / A
ENGINE	MODELS	FROM / TO
V8 6.5L/6.2L OHV 16V DIESEL VIN J	SUBURBAN, VAN, C1500, C2500, C3500, HUMMER	1982/2004

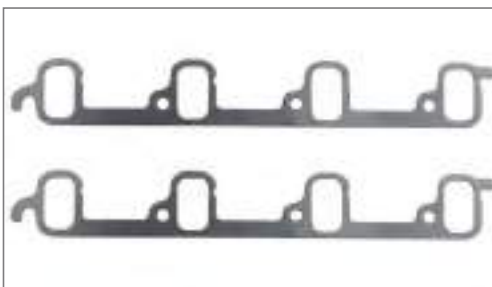



GM CHEVROLET

MS-4180-P

MOTOR	MODELOS	DESDE / A
ENGINE	MODELS	FROM / TO
V8 6.5L/6.2L OHV 16V DIESEL VIN J	SUBURBAN, VAN,C1500,C2500,- C3500,HUMMER	1992/2002



FORD

OS-1396

MOTOR	MODELOS	DESDE / A
ENGINE	MODELS	FROM / TO
V8 420-445 (6.9L-7.3L)	FORD DIESEL	1983/1994

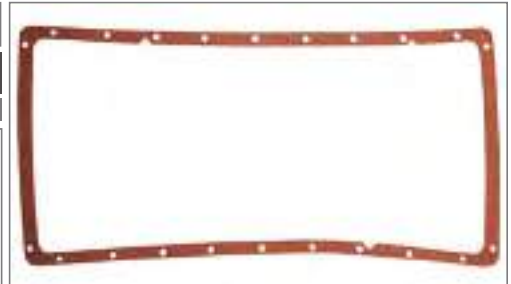

GM CHEVROLET

OS-1180-A

MOTOR	MODELOS	DESDE / A
ENGINE	MODELS	FROM / TO
V8 6.5L/6.2L OHV 16V DIESEL VIN J	CAMIONES DIESEL	1992/2004



FORD

TC-6396

MOTOR	MODELOS	DESDE / A
ENGINE	MODELS	FROM / TO
V8 6.9L/7.3L 16V OHV DIESEL	FORD DIESEL	1983/1994



FORD

TC-6396-1

MOTOR	MODELOS	DESDE / A
ENGINE	MODELS	FROM / TO
V8 6.9L/7.3L 16V OHV DIESEL	FORD DIESEL	1994/1995

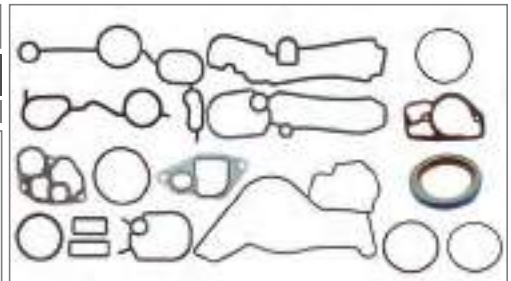

FORD

TC-6396-2

MOTOR	MODELOS	DESDE / A
ENGINE	MODELS	FROM / TO
V8 7.3L 16V OHV DIESEL VIN F	FORD DIESEL	1996/1999

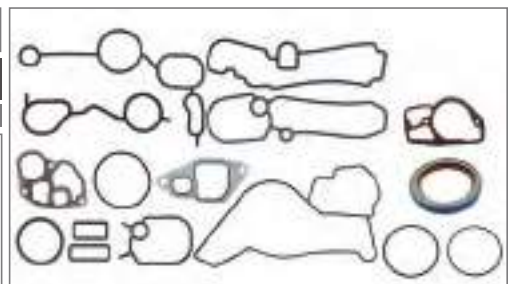



FORD

SS-8396-V

MOTOR	MODELOS	DESDE / A
ENGINE	MODELS	FROM / TO
V8 7.3L 16V OHV DIESEL VIN F	FORD DIESEL	1988/1994



FORD

SS-8396-1V

MOTOR	MODELOS	DESDE / A
ENGINE	MODELS	FROM / TO
V8 7.3L (445 CID) 16V DIESEL VIN F	FORD DIESEL	1994/2001



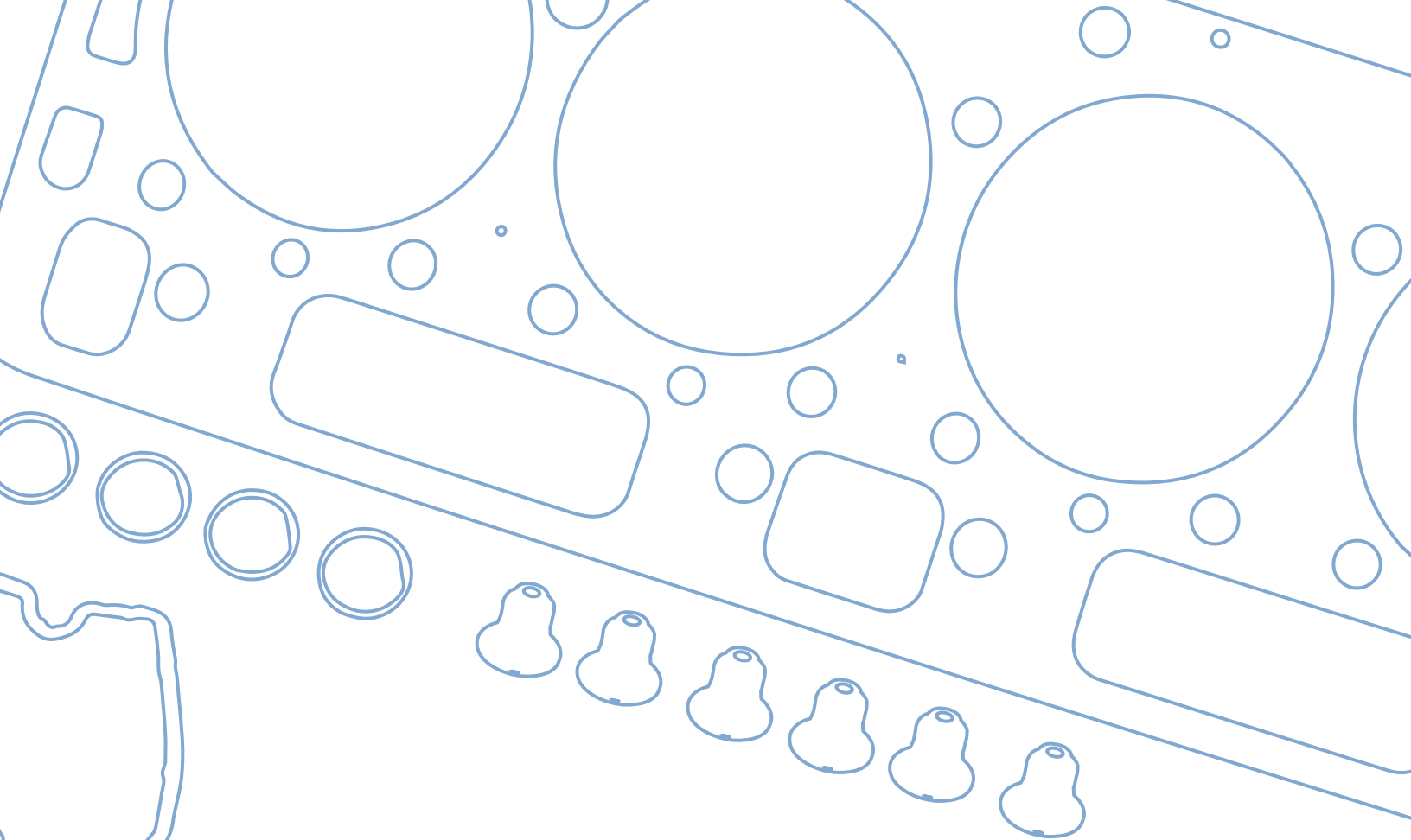

SELLOS DE VÁLVULA **/ VALVE STEM SEALS**

SECCIÓN
/SECTION

CATÁLOGO DE APLICACIONES / APPLICATION CATALOG

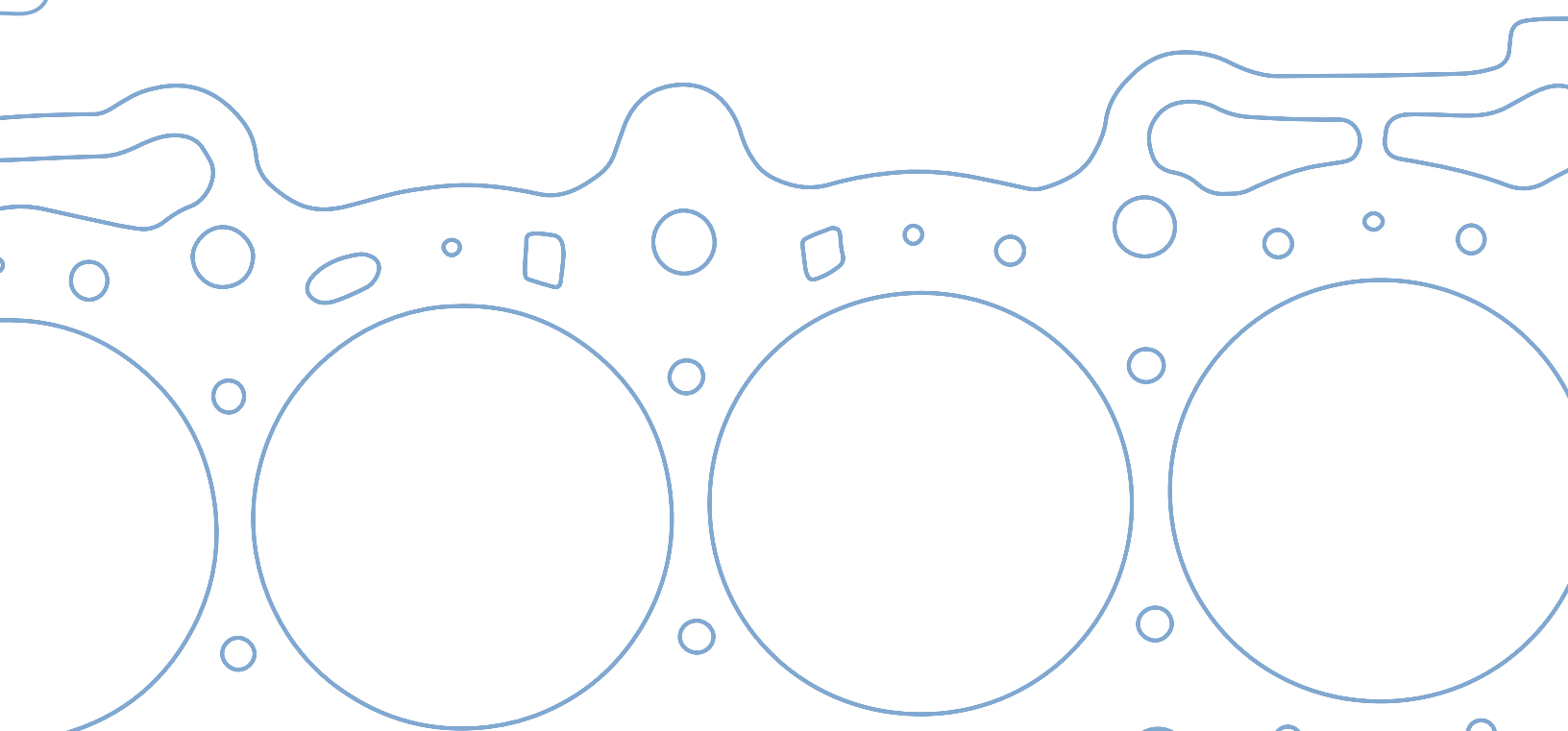



DIÁMETRO DE VÁLVULA (VÁSTAGO)

ALTURA
TOTAL

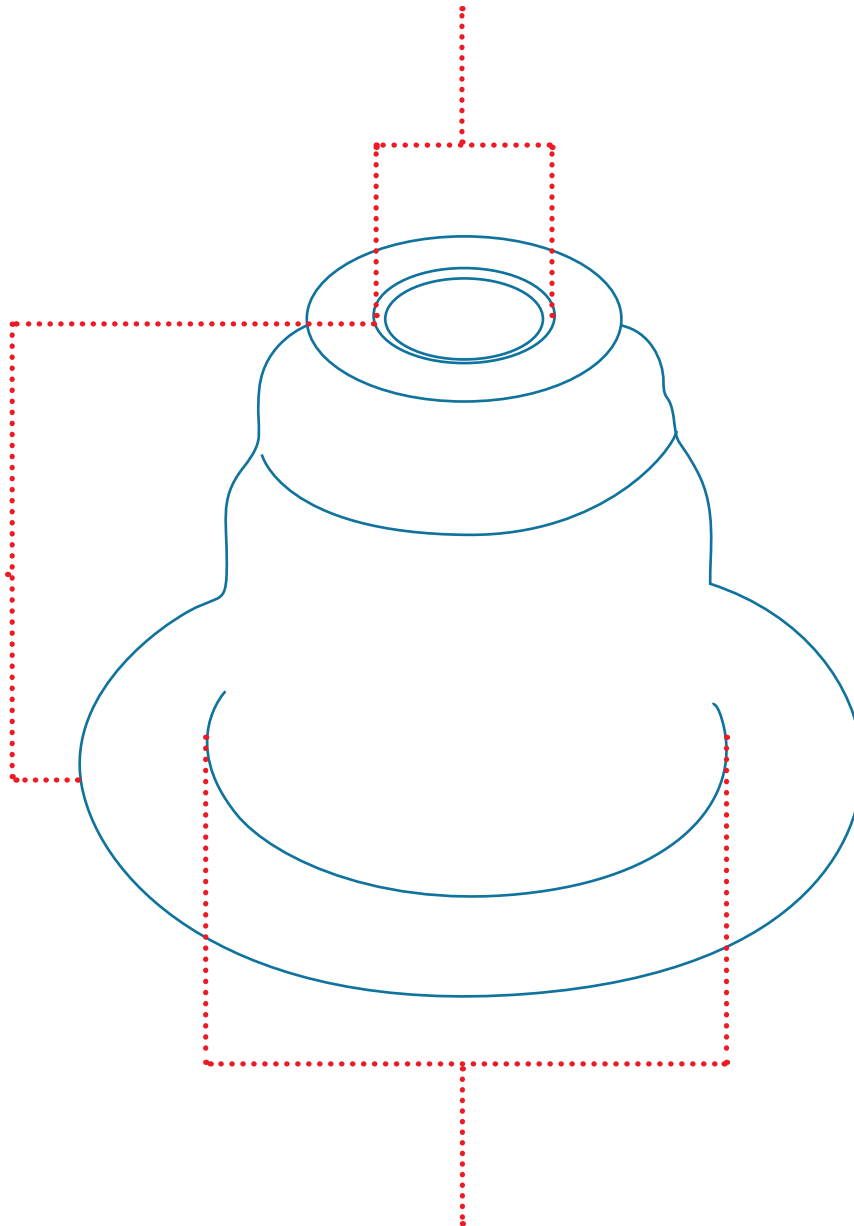



DIÁMETRO DE GUÍA INTERIOR





	SS-8252-1V/SS-8252-V/SV-8252-V/SV-81361-V		
	DIÁMETRO DE VALVULA	DIÁMETRO DE GUÍA	ALTURA
	VALVE DIAMETER	BORE GUIDE	HEIGHT
	5.3 mm.	10.8 mm.	10.7 mm.

	SS-8116-R / SV-8116-S		
	DIÁMETRO DE VALVULA	DIÁMETRO DE GUÍA	ALTURA
	VALVE DIAMETER	BORE GUIDE	HEIGHT
	4.6 mm.	9mm.	9.2 mm.

	SV-8250-N		
	DIÁMETRO DE VALVULA	DIÁMETRO DE GUÍA	ALTURA
	VALVE DIAMETER	BORE GUIDE	HEIGHT
	3.8 mm.	7.4 mm.	8.2mm.

	SS-8348-V/SV-8348-V		
	DIÁMETRO DE VALVULA	DIÁMETRO DE GUÍA	ALTURA
	VALVE DIAMETER	BORE GUIDE	HEIGHT
	4.7 mm.	10.8 mm.	18.1 mm.

	SS-8250-1N / SS-8250-N / SS-8253		
	DIÁMETRO DE VALVULA	DIÁMETRO DE GUÍA	ALTURA
	VALVE DIAMETER	BORE GUIDE	HEIGHT
	4.1 mm.	7.4 mm.	7.5 mm.

	SS-8226-V / SV-8226-V		
	DIÁMETRO DE VALVULA	DIÁMETRO DE GUÍA	ALTURA
	VALVE DIAMETER	BORE GUIDE	HEIGHT
	4.8 mm.	10.5 mm.	19.8 mm

	SV-8114-1V		
	DIÁMETRO DE VALVULA	DIÁMETRO DE GUÍA	ALTURA
	VALVE DIAMETER	BORE GUIDE	HEIGHT
	4.3 mm.	7.7 mm.	7.9 mm.

	SS-81550-V / SV-81550-V		
	DIÁMETRO DE VALVULA	DIÁMETRO DE GUÍA	ALTURA
	VALVE DIAMETER	BORE GUIDE	HEIGHT
	4.8 mm.	10.9 mm.	16.4 mm.

	SS-8119-V / SV-8119-V		
	DIÁMETRO DE VALVULA	DIÁMETRO DE GUÍA	ALTURA
	VALVE DIAMETER	BORE GUIDE	HEIGHT
	4.3 mm.	9.8 mm.	17.8 mm.

	SV-81238		
	DIÁMETRO DE VALVULA	DIÁMETRO DE GUÍA	ALTURA
	VALVE DIAMETER	BORE GUIDE	HEIGHT
	4.9 mm.	9.3 mm.	11.4 mm.

	SS-81226-V / SV-81226-V		
	DIÁMETRO DE VALVULA	DIÁMETRO DE GUÍA	ALTURA
	VALVE DIAMETER	BORE GUIDE	HEIGHT
	4.4 mm.	9.1 mm.	11.4 mm.

	SS-8252-S		
	DIÁMETRO DE VALVULA	DIÁMETRO DE GUÍA	ALTURA
	VALVE DIAMETER	BORE GUIDE	HEIGHT
	5 mm.	10.7 mm.	11.8 mm.
	5 mm.	10.6 mm.	10.7 mm.

	SS-8122-V / SV-8122-V		
	DIÁMETRO DE VALVULA	DIÁMETRO DE GUÍA	ALTURA
	VALVE DIAMETER	BORE GUIDE	HEIGHT
	4.5 mm.	7.5 mm.	15.3 mm.

	SS-8357-1V / SV-8357-1V		
	DIÁMETRO DE VALVULA	DIÁMETRO DE GUÍA	ALTURA
	VALVE DIAMETER	BORE GUIDE	HEIGHT
	5 mm.	10.4 mm	19.1 mm.



SS-81452-V / SV-81452-V		
DIÁMETRO DE VALVULA	DIÁMETRO DE GUÍA	ALTURA
VALVE DIAMETER	BORE GUIDE	HEIGHT
5 mm.	10.9 mm.	10 mm.

SS-81852-V / SV-81852-V		
DIÁMETRO DE VALVULA	DIÁMETRO DE GUÍA	ALTURA
VALVE DIAMETER	BORE GUIDE	HEIGHT
5.1 mm.	8.6 mm.	10 mm.

SS-8102-1V / SV-8102-1V		
DIÁMETRO DE VALVULA	DIÁMETRO DE GUÍA	ALTURA
VALVE DIAMETER	BORE GUIDE	HEIGHT
5.1 mm.	10.8 mm.	15.9 mm.

SS-8114-V / SV-8114-V		
DIÁMETRO DE VALVULA	DIÁMETRO DE GUÍA	ALTURA
VALVE DIAMETER	BORE GUIDE	HEIGHT
5.2 mm.	8.6 mm.	10 mm.

SS-8117-V / SV-8117-V		
DIÁMETRO DE VALVULA	DIÁMETRO DE GUÍA	ALTURA
VALVE DIAMETER	BORE GUIDE	HEIGHT
5.1 mm.	8.4 mm.	10.1 mm.

SS-8153-V / SV-8153-V		
DIÁMETRO DE VALVULA	DIÁMETRO DE GUÍA	ALTURA
VALVE DIAMETER	BORE GUIDE	HEIGHT
5.2 mm.	10 mm.	18.6 mm.

SS-8252-S / SV-8252-S		
DIÁMETRO DE VALVULA	DIÁMETRO DE GUÍA	ALTURA
VALVE DIAMETER	BORE GUIDE	HEIGHT
5.0 mm.	10.6 mm.	10.7 mm.
5.1 mm.	10.7 mm.	11.8 mm.

SS-8183-V		
DIÁMETRO DE VALVULA	DIÁMETRO DE GUÍA	ALTURA
VALVE DIAMETER	BORE GUIDE	HEIGHT
5.2 mm.	10.9 mm.	19.7 mm.

SS-8357-2V / SV-8357-2V		
DIÁMETRO DE VALVULA	DIÁMETRO DE GUÍA	ALTURA
VALVE DIAMETER	BORE GUIDE	HEIGHT
5.1 mm.	10.2 mm.	17.8 mm.

SS-81227 / SV-81227		
DIÁMETRO DE VALVULA	DIÁMETRO DE GUÍA	ALTURA
VALVE DIAMETER	BORE GUIDE	HEIGHT
5.2 mm.	10.8 mm.	11 mm.
5.2 mm.	9.8 mm.	11.5 mm.

SS-81357-S / SV-81357-S		
DIÁMETRO DE VALVULA	DIÁMETRO DE GUÍA	ALTURA
VALVE DIAMETER	BORE GUIDE	HEIGHT
5.1 mm.	11.1 mm.	11.2 mm.

SS-8201-PA / SS-81227/SV-8201-PA/SV-81228		
DIÁMETRO DE VALVULA	DIÁMETRO DE GUÍA	ALTURA
VALVE DIAMETER	BORE GUIDE	HEIGHT
5.2 mm.	9.8 mm.	11.5 mm.

SS-81468-V		
DIÁMETRO DE VALVULA	DIÁMETRO DE GUÍA	ALTURA
VALVE DIAMETER	BORE GUIDE	HEIGHT
5.1 mm.	11 mm.	10.3 mm.

SS-8280-V / SV-8280-V		
DIÁMETRO DE VALVULA	DIÁMETRO DE GUÍA	ALTURA
VALVE DIAMETER	BORE GUIDE	HEIGHT
5.3 mm.	10.7 mm.	18.2 mm.



	SS-8307-V / SV-8307-V		
	DIÁMETRO DE VALVULA	DIÁMETRO DE GUÍA	ALTURA
	VALVE DIAMETER	BORE GUIDE	HEIGHT
	5.3 mm.	10.5 mm.	15.9 mm.

	SS-8115-V		
	DIÁMETRO DE VALVULA	DIÁMETRO DE GUÍA	ALTURA
	VALVE DIAMETER	BORE GUIDE	HEIGHT
	5.5 mm.	11 mm.	13 mm.

	SS-81357-V / SV-81357-V		
	DIÁMETRO DE VALVULA	DIÁMETRO DE GUÍA	ALTURA
	VALVE DIAMETER	BORE GUIDE	HEIGHT
	5.3 mm.	10.8 mm.	9 mm.

	SV-8313-1V		
	DIÁMETRO DE VALVULA	DIÁMETRO DE GUÍA	ALTURA
	VALVE DIAMETER	BORE GUIDE	HEIGHT
	5.5 mm.	11.9 mm.	20.5 mm

	SS-8109-S / SS-8319-V / SV-8109-S		
	DIÁMETRO DE VALVULA	DIÁMETRO DE GUÍA	ALTURA
	VALVE DIAMETER	BORE GUIDE	HEIGHT
	5.4 mm.	10.6 mm.	10.2 mm.

	SS-8100-V / SV-8100-V		
	DIÁMETRO DE VALVULA	DIÁMETRO DE GUÍA	ALTURA
	VALVE DIAMETER	BORE GUIDE	HEIGHT
	5.6 mm.	10.7 mm.	9.5 mm.

	SS-8311-V / SV-8311-V		
	DIÁMETRO DE VALVULA	DIÁMETRO DE GUÍA	ALTURA
	VALVE DIAMETER	BORE GUIDE	HEIGHT
	5.4 mm.	12.2 mm.	18.8 mm.

	SS-8113-V / SV-8113-V		
	DIÁMETRO DE VALVULA	DIÁMETRO DE GUÍA	ALTURA
	VALVE DIAMETER	BORE GUIDE	HEIGHT
	5.7 mm.	9.9 mm.	15.3 mm.

	SS-81236-V		
	DIÁMETRO DE VALVULA	DIÁMETRO DE GUÍA	ALTURA
	VALVE DIAMETER	BORE GUIDE	HEIGHT
	5.4 mm.	9.9 mm.	11.3 mm.

	SS-8133-V		
	DIÁMETRO DE VALVULA	DIÁMETRO DE GUÍA	ALTURA
	VALVE DIAMETER	BORE GUIDE	HEIGHT
	5.7 mm.	10.9 mm.	9.7 mm.

	SS-81305		
	DIÁMETRO DE VALVULA	DIÁMETRO DE GUÍA	ALTURA
	VALVE DIAMETER	BORE GUIDE	HEIGHT
	5.4 mm.	11 mm.	9.1 mm.

	SS-8242-V / SV-8242-V		
	DIÁMETRO DE VALVULA	DIÁMETRO DE GUÍA	ALTURA
	VALVE DIAMETER	BORE GUIDE	HEIGHT
	5.7 mm.	11.1 mm	18.4 mm.

	SS-8103-V / SV-8103-V		
	DIÁMETRO DE VALVULA	DIÁMETRO DE GUÍA	ALTURA
	VALVE DIAMETER	BORE GUIDE	HEIGHT
	5.5 mm.	11.5 mm.	9.5 mm.

	SS-8317-V / SV-8317-V		
	DIÁMETRO DE VALVULA	DIÁMETRO DE GUÍA	ALTURA
	VALVE DIAMETER	BORE GUIDE	HEIGHT
	5.8 mm.	11 mm	18 mm.



	SS-81467-V		
	DIÁMETRO DE VALVULA	DIÁMETRO DE GUÍA	ALTURA
	VALVE DIAMETER	BORE GUIDE	HEIGHT
	6.0 mm.	9.3 mm.	8.6 mm.
	5.8 mm.	11.8 mm.	9.7 mm.

	SS-81225-1 / SS-81229		
	DIÁMETRO DE VALVULA	DIÁMETRO DE GUÍA	ALTURA
	VALVE DIAMETER	BORE GUIDE	HEIGHT
	6 mm.	10.6 mm.	12.6 mm.

	SV-81845-V		
	DIÁMETRO DE VALVULA	DIÁMETRO DE GUÍA	ALTURA
	VALVE DIAMETER	BORE GUIDE	HEIGHT
	5.9 mm.	9.5 mm.	9.9 mm.

	SS-8112-V / SV-8112-V		
	DIÁMETRO DE VALVULA	DIÁMETRO DE GUÍA	ALTURA
	VALVE DIAMETER	BORE GUIDE	HEIGHT
	6.1 mm.	12.7 mm.	20.2 mm.

	SS-8230-PA / SV-8230-PA		
	DIÁMETRO DE VALVULA	DIÁMETRO DE GUÍA	ALTURA
	VALVE DIAMETER	BORE GUIDE	HEIGHT
	6 mm.	11.6 mm.	11.9 mm.

	SS-8249-V / SV-8249-V		
	DIÁMETRO DE VALVULA	DIÁMETRO DE GUÍA	ALTURA
	VALVE DIAMETER	BORE GUIDE	HEIGHT
	6.1 mm.	12.5 mm.	16 mm.

	SS-8268-V / SV-8268-V		
	DIÁMETRO DE VALVULA	DIÁMETRO DE GUÍA	ALTURA
	VALVE DIAMETER	BORE GUIDE	HEIGHT
	6 mm.	11.1 mm.	16.8 mm.

	SS-8302-V		
	DIÁMETRO DE VALVULA	DIÁMETRO DE GUÍA	ALTURA
	VALVE DIAMETER	BORE GUIDE	HEIGHT
	6.1 mm.	9.6 mm.	9.7 mm.

	SS-8341-V / SV-8341-V		
	DIÁMETRO DE VALVULA	DIÁMETRO DE GUÍA	ALTURA
	VALVE DIAMETER	BORE GUIDE	HEIGHT
	6 mm.	12.6 mm.	21.5 mm.

	SS-8337-V / SV-8337-V		
	DIÁMETRO DE VALVULA	DIÁMETRO DE GUÍA	ALTURA
	VALVE DIAMETER	BORE GUIDE	HEIGHT
	6.1 mm.	11.7 mm.	16.3 mm.

	SS-8341-1V / SV-8341-1V (Base grande)		
	DIÁMETRO DE VALVULA	DIÁMETRO DE GUÍA	ALTURA
	VALVE DIAMETER	BORE GUIDE	HEIGHT
	6 mm.	12.7 mm.	21 mm.

	SV-81225-V		
	DIÁMETRO DE VALVULA	DIÁMETRO DE GUÍA	ALTURA
	VALVE DIAMETER	BORE GUIDE	HEIGHT
	6.1 mm.	10.6 mm.	10.7 mm.

	SS-81216 / SV-81216		
	DIÁMETRO DE VALVULA	DIÁMETRO DE GUÍA	ALTURA
	VALVE DIAMETER	BORE GUIDE	HEIGHT
	6 mm.	11.6 mm.	14.8 mm.

	SS-81303-N		
	DIÁMETRO DE VALVULA	DIÁMETRO DE GUÍA	ALTURA
	VALVE DIAMETER	BORE GUIDE	HEIGHT
	6.1 mm.	11.4 mm.	9.5 mm.

** Para ver aplicación dirigirse a catálogo electrónico: catalogo.dcp.com.mx.



	SV-8262-V		
	DIÁMETRO DE VALVULA	DIÁMETRO DE GUÍA	ALTURA
	VALVE DIAMETER	BORE GUIDE	HEIGHT
	6.2 mm.	11 mm.	17 mm.

	SS-8271-12V / SS-8271-1V / SV-8271-V		
	DIÁMETRO DE VALVULA	DIÁMETRO DE GUÍA	ALTURA
	VALVE DIAMETER	BORE GUIDE	HEIGHT
	6.4 mm.	11.7 mm.	18.7 mm.

	SS-81240-PA / SV-81240-PA		
	DIÁMETRO DE VALVULA	DIÁMETRO DE GUÍA	ALTURA
	VALVE DIAMETER	BORE GUIDE	HEIGHT
	6.2 mm.	10.8 mm.	11.7 mm.

	SV-8303-P		
	DIÁMETRO DE VALVULA	DIÁMETRO DE GUÍA	ALTURA
	VALVE DIAMETER	BORE GUIDE	HEIGHT
	6.4 mm.	11.5 mm.	9.1 mm.

	SS-8108-V / SV-8108-V		
	DIÁMETRO DE VALVULA	DIÁMETRO DE GUÍA	ALTURA
	VALVE DIAMETER	BORE GUIDE	HEIGHT
	6.3 mm.	11.4 mm.	12 mm.

	SV-81216-V		
	DIÁMETRO DE VALVULA	DIÁMETRO DE GUÍA	ALTURA
	VALVE DIAMETER	BORE GUIDE	HEIGHT
	6.4 mm.	11.7 mm.	15.2 mm

	SS-8111-S / SV-8111-S		
	DIÁMETRO DE VALVULA	DIÁMETRO DE GUÍA	ALTURA
	VALVE DIAMETER	BORE GUIDE	HEIGHT
	6.3 mm.	11.6 mm.	18.6 mm.

	SS-8111-V		
	DIÁMETRO DE VALVULA	DIÁMETRO DE GUÍA	ALTURA
	VALVE DIAMETER	BORE GUIDE	HEIGHT
	6.5 mm.	11.1 mm.	14.2 mm.

	SS-8356-V / SV-8356-V		
	DIÁMETRO DE VALVULA	DIÁMETRO DE GUÍA	ALTURA
	VALVE DIAMETER	BORE GUIDE	HEIGHT
	6.3 mm.	10.6 mm.	20.5 mm.

	SS-8250-V / SV-8250-V		
	DIÁMETRO DE VALVULA	DIÁMETRO DE GUÍA	ALTURA
	VALVE DIAMETER	BORE GUIDE	HEIGHT
	6.8 mm.	12.8 mm.	12.9 mm.

	SS-8357-V / SV-8357-V		
	DIÁMETRO DE VALVULA	DIÁMETRO DE GUÍA	ALTURA
	VALVE DIAMETER	BORE GUIDE	HEIGHT
	6.3mm.	12 mm.	20.1 mm.

	SV-8335-V		
	DIÁMETRO DE VALVULA	DIÁMETRO DE GUÍA	ALTURA
	VALVE DIAMETER	BORE GUIDE	HEIGHT
	6.8 mm.	11.7 mm.	8.6 mm.

	SS-8109-1V / SS-8109-V / SV-8109-1V		
	DIÁMETRO DE VALVULA	DIÁMETRO DE GUÍA	ALTURA
	VALVE DIAMETER	BORE GUIDE	HEIGHT
	6.4 mm.	12.9 mm.	12.9 mm.

	SS-8110 / SS-8180-V / SV-8110		
	DIÁMETRO DE VALVULA	DIÁMETRO DE GUÍA	ALTURA
	VALVE DIAMETER	BORE GUIDE	HEIGHT
	0.7 mm.		0.2 mm.



	SS-8145-V / SV-8145-V		
	DIÁMETRO DE VALVULA	DIÁMETRO DE GUÍA	ALTURA
	VALVE DIAMETER	BORE GUIDE	HEIGHT
	7 mm.	13.9 mm.	22.9 mm.

	SS-81120-V / SV-81120-V		
	DIÁMETRO DE VALVULA	DIÁMETRO DE GUÍA	ALTURA
	VALVE DIAMETER	BORE GUIDE	HEIGHT
	7.1 mm.	12.7 mm.	9.9 mm.

	SS-8240-1V / SV-8240-1V		
	DIÁMETRO DE VALVULA	DIÁMETRO DE GUÍA	ALTURA
	VALVE DIAMETER	BORE GUIDE	HEIGHT
	7mm.	10.8 mm.	13.7 mm.

	SS-81218 / SS-81225-1 / SS-81229 / SV-81218		
	DIÁMETRO DE VALVULA	DIÁMETRO DE GUÍA	ALTURA
	VALVE DIAMETER	BORE GUIDE	HEIGHT
	7.1 mm.	11.3 mm.	14.3 mm.

	SS-81210 / SV-81210		
	DIÁMETRO DE VALVULA	DIÁMETRO DE GUÍA	ALTURA
	VALVE DIAMETER	BORE GUIDE	HEIGHT
	7 mm.	14.1 mm.	20.9 mm.

	SS-81321-N		
	DIÁMETRO DE VALVULA	DIÁMETRO DE GUÍA	ALTURA
	VALVE DIAMETER	BORE GUIDE	HEIGHT
	7.1 mm.	12.8 mm.	10 mm

	SS-81215 / SV-81215		
	DIÁMETRO DE VALVULA	DIÁMETRO DE GUÍA	ALTURA
	VALVE DIAMETER	BORE GUIDE	HEIGHT
	7 mm.	11.8 mm.	13.5 mm.

	SS-8301-V / SV-8301-V		
	DIÁMETRO DE VALVULA	DIÁMETRO DE GUÍA	ALTURA
	VALVE DIAMETER	BORE GUIDE	HEIGHT
	7.2 mm.	11.9 mm.	17.9 mm.

	SS-81830 / SV-81830		
	DIÁMETRO DE VALVULA	DIÁMETRO DE GUÍA	ALTURA
	VALVE DIAMETER	BORE GUIDE	HEIGHT
	7 mm.	10.6 mm.	10.4 mm.

	SV-8304		
	DIÁMETRO DE VALVULA	DIÁMETRO DE GUÍA	ALTURA
	VALVE DIAMETER	BORE GUIDE	HEIGHT
	7.2 mm.	12.7 mm.	13.2 mm.

	SS-8141-V / SV-8141-V		
	DIÁMETRO DE VALVULA	DIÁMETRO DE GUÍA	ALTURA
	VALVE DIAMETER	BORE GUIDE	HEIGHT
	7.1 mm.	11.4 mm.	12.2 mm.

	SS-81350-V		
	DIÁMETRO DE VALVULA	DIÁMETRO DE GUÍA	ALTURA
	VALVE DIAMETER	BORE GUIDE	HEIGHT
	7.2 mm.	12.6 mm.	10 mm.
	7.9 mm.	12.2 mm.	13.2 mm.

	SS-8304-V / SV-81110		
	DIÁMETRO DE VALVULA	DIÁMETRO DE GUÍA	ALTURA
	VALVE DIAMETER	BORE GUIDE	HEIGHT
	7.1 mm.	13.9 mm.	13 mm.

	SV-50		
	DIÁMETRO DE VALVULA	DIÁMETRO DE GUÍA	ALTURA
	VALVE DIAMETER	BORE GUIDE	HEIGHT
	7.3 mm.	12.5 mm.	11.5 mm.

** Para ver aplicación dirigirse a catálogo electrónico: catalogo.dcp.com.mx.



	SS-8152-V / SV-8152-V		
	DIÁMETRO DE VALVULA	DIÁMETRO DE GUÍA	ALTURA
	VALVE DIAMETER	BORE GUIDE	HEIGHT
	7.3 mm.	12.1 mm.	14 mm.

	SS-8396-1V		
	DIÁMETRO DE VALVULA	DIÁMETRO DE GUÍA	ALTURA
	VALVE DIAMETER	BORE GUIDE	HEIGHT
	7.4 mm.	14 mm.	28.1 mm.

	SS-8240-N / SV-8240-N		
	DIÁMETRO DE VALVULA	DIÁMETRO DE GUÍA	ALTURA
	VALVE DIAMETER	BORE GUIDE	HEIGHT
	7.3 mm.	10.9 mm.	13.7 mm.

	SS-8105-V / SV-8105-V		
	DIÁMETRO DE VALVULA	DIÁMETRO DE GUÍA	ALTURA
	VALVE DIAMETER	BORE GUIDE	HEIGHT
	7.4 mm.	10.5 mm.	11.1 mm.
	7.5 mm.	10.9 mm.	11.2 mm.

	SS-8273-V / SV-8273-V		
	DIÁMETRO DE VALVULA	DIÁMETRO DE GUÍA	ALTURA
	VALVE DIAMETER	BORE GUIDE	HEIGHT
	7.3 mm.	13.7 mm.	26.3 mm.

	SS-8240-S / SV-8240-S		
	DIÁMETRO DE VALVULA	DIÁMETRO DE GUÍA	ALTURA
	VALVE DIAMETER	BORE GUIDE	HEIGHT
	7.5 mm.	11.1 mm.	13.5 mm.

	SS-81310-N / SV-81310-N		
	DIÁMETRO DE VALVULA	DIÁMETRO DE GUÍA	ALTURA
	VALVE DIAMETER	BORE GUIDE	HEIGHT
	7.3 mm.	12.8 mm.	9.7 mm.

	SS-8240-V / SV-8240-V		
	DIÁMETRO DE VALVULA	DIÁMETRO DE GUÍA	ALTURA
	VALVE DIAMETER	BORE GUIDE	HEIGHT
	7.5 mm.	10.9 mm.	13.6 mm.

	SS-8105-V		
	DIÁMETRO DE VALVULA	DIÁMETRO DE GUÍA	ALTURA
	VALVE DIAMETER	BORE GUIDE	HEIGHT
	7.4 mm.	10.5 mm.	11.1 mm.
	7.5 mm.	10.9 mm.	11.2 mm.

	SS-8140-12P/SS-8140-16P/SS-8140-8P/SV-8140-P		
	DIÁMETRO DE VALVULA	DIÁMETRO DE GUÍA	ALTURA
	VALVE DIAMETER	BORE GUIDE	HEIGHT
	7.6 mm.	12 mm.	12.1 mm.

	SS-8152-1V / SV-8152-1V		
	DIÁMETRO DE VALVULA	DIÁMETRO DE GUÍA	ALTURA
	VALVE DIAMETER	BORE GUIDE	HEIGHT
	7.4 mm.	12.5 mm.	22.6 mm.

	SS-8160-12V / SS-8160-16V / SV-8160-V		
	DIÁMETRO DE VALVULA	DIÁMETRO DE GUÍA	ALTURA
	VALVE DIAMETER	BORE GUIDE	HEIGHT
	7.6 mm.	13.9 mm.	13.47 mm.

	SS-8270-V / SV-8270-V		
	DIÁMETRO DE VALVULA	DIÁMETRO DE GUÍA	ALTURA
	VALVE DIAMETER	BORE GUIDE	HEIGHT
	7.4 mm.	13.2 mm.	13 mm.

	SS-8365 / SV-8365		
	DIÁMETRO DE VALVULA	DIÁMETRO DE GUÍA	ALTURA
	VALVE DIAMETER	BORE GUIDE	HEIGHT
	7.7 mm.	17.5 mm.	18.2 mm.



	SS-8220-A / SV-8220-A		
	DIÁMETRO DE VALVULA	DIÁMETRO DE GUÍA	ALTURA
	VALVE DIAMETER	BORE GUIDE	HEIGHT
	7.7 mm.	18 mm.	17.3 mm.

	SS-8310 / SV-8310		
	DIÁMETRO DE VALVULA	DIÁMETRO DE GUÍA	ALTURA
	VALVE DIAMETER	BORE GUIDE	HEIGHT
	8 mm.	18 mm.	10 mm.

	SS-8150-12V/SS-8150-16V/SS-8150-8V/SS-8330-1V/SV-8150-V		
	DIÁMETRO DE VALVULA	DIÁMETRO DE GUÍA	ALTURA
	VALVE DIAMETER	BORE GUIDE	HEIGHT
	7.9 mm.	12 mm.	12 mm.

	SS-8710 / SV-8710		
	DIÁMETRO DE VALVULA	DIÁMETRO DE GUÍA	ALTURA
	VALVE DIAMETER	BORE GUIDE	HEIGHT
	8 mm.	19.8 mm.	17.3 mm.

	SS-8313-V / SV-8313-V		
	DIÁMETRO DE VALVULA	DIÁMETRO DE GUÍA	ALTURA
	VALVE DIAMETER	BORE GUIDE	HEIGHT
	5.7 mm.	11.8 mm.	20.2 mm.

	SV-50-S		
	DIÁMETRO DE VALVULA	DIÁMETRO DE GUÍA	ALTURA
	VALVE DIAMETER	BORE GUIDE	HEIGHT
	8.1 mm.	13.7 mm.	11.5 mm.

	SS-8330 / SV-8330		
	DIÁMETRO DE VALVULA	DIÁMETRO DE GUÍA	ALTURA
	VALVE DIAMETER	BORE GUIDE	HEIGHT
	7.9 mm.	12.4 mm.	13.1 mm.

	SS-8180-V		
	DIÁMETRO DE VALVULA	DIÁMETRO DE GUÍA	ALTURA
	VALVE DIAMETER	BORE GUIDE	HEIGHT
	8.1 mm.	14.8 mm.	10.2 mm.

	SS-8150-1P		
	DIÁMETRO DE VALVULA	DIÁMETRO DE GUÍA	ALTURA
	VALVE DIAMETER	BORE GUIDE	HEIGHT
	8 mm.	16.1 mm.	14 mm.

	SS-8520 / SV-8520		
	DIÁMETRO DE VALVULA	DIÁMETRO DE GUÍA	ALTURA
	VALVE DIAMETER	BORE GUIDE	HEIGHT
	8.1 mm.	16.1 mm.	19 mm.

	SS-8330-V / SV-8330-V		
	DIÁMETRO DE VALVULA	DIÁMETRO DE GUÍA	ALTURA
	VALVE DIAMETER	BORE GUIDE	HEIGHT
	8 mm.	12.3 mm.	13.5 mm.

	SS-8355 / SV-8355		
	DIÁMETRO DE VALVULA	DIÁMETRO DE GUÍA	ALTURA
	VALVE DIAMETER	BORE GUIDE	HEIGHT
	8.1 mm.	18.1 mm.	19.3 mm.

	SV-8250-N		
	DIÁMETRO DE VALVULA	DIÁMETRO DE GUÍA	ALTURA
	VALVE DIAMETER	BORE GUIDE	HEIGHT
	3.8 mm.	7.4	8.2 mm.

	SS-8300 / SS-8330-1V / SV-8300		
	DIÁMETRO DE VALVULA	DIÁMETRO DE GUÍA	ALTURA
	VALVE DIAMETER	BORE GUIDE	HEIGHT
	8.2 mm.	12.5 mm.	11.8 mm.

** Para ver aplicación dirigirse a catálogo electrónico: catalogo.dcp.com.mx.





	SS-8260 / SS-8260-1 / SV-8260		
	DIÁMETRO DE VALVULA	DIÁMETRO DE GUÍA	ALTURA
	VALVE DIAMETER	BORE GUIDE	HEIGHT
	8.2 mm.	13.8 mm.	13.4 mm.
	9.2 mm.	19 mm.	6.3 mm.

	SS-8164-N		
	DIÁMETRO DE VALVULA	DIÁMETRO DE GUÍA	ALTURA
	VALVE DIAMETER	BORE GUIDE	HEIGHT
	8.9 mm.	14.9 mm.	11.3 mm

	SS-8331-1V / SS-8331-V / SV-8305-1V		
	DIÁMETRO DE VALVULA	DIÁMETRO DE GUÍA	ALTURA
	VALVE DIAMETER	BORE GUIDE	HEIGHT
	8.2 mm.	13.8 mm.	15 mm.

	SS-8220-E / SS-8260-1 / SV-8220-E		
	DIÁMETRO DE VALVULA	DIÁMETRO DE GUÍA	ALTURA
	VALVE DIAMETER	BORE GUIDE	HEIGHT
	8.2 mm.	13.8 mm.	13.4 mm.
	9.2 mm.	19 mm.	6.3 mm.

	SS-8305-12V / SS-8305-16V / SS-8305-8V / SV-8305-V		
	DIÁMETRO DE VALVULA	DIÁMETRO DE GUÍA	ALTURA
	VALVE DIAMETER	BORE GUIDE	HEIGHT
	8.2 mm.	13.9 mm.	14.9 mm.

	SS-8396-V		
	DIÁMETRO DE VALVULA	DIÁMETRO DE GUÍA	ALTURA
	VALVE DIAMETER	BORE GUIDE	HEIGHT
	9.2 mm.	19.4 mm.	13.8 mm.
	8.5 mm.	14.2 mm.	12.1 mm.

	SS-86000 / SV-86000		
	DIÁMETRO DE VALVULA	DIÁMETRO DE GUÍA	ALTURA
	VALVE DIAMETER	BORE GUIDE	HEIGHT
	8.2 mm.	15.6 mm.	12.4 mm.

	SS-8167-NV / SS-8167-V / SV-8167-NV		
	DIÁMETRO DE VALVULA	DIÁMETRO DE GUÍA	ALTURA
	VALVE DIAMETER	BORE GUIDE	HEIGHT
	8.3 mm.	19.6 mm.	20.5 mm.

	SS-8261-1V / SV-8261-V		
	DIÁMETRO DE VALVULA	DIÁMETRO DE GUÍA	ALTURA
	VALVE DIAMETER	BORE GUIDE	HEIGHT
	8.6 mm.	15.9 mm.	17.5 mm.

	SS-8181-V / SV-8181-V		
	DIÁMETRO DE VALVULA	DIÁMETRO DE GUÍA	ALTURA
	VALVE DIAMETER	BORE GUIDE	HEIGHT
	8.7 mm.	15.3 mm.	12.9 mm.



NOTAS / NOTES:

A large area of horizontal lines for writing notes or specifications.

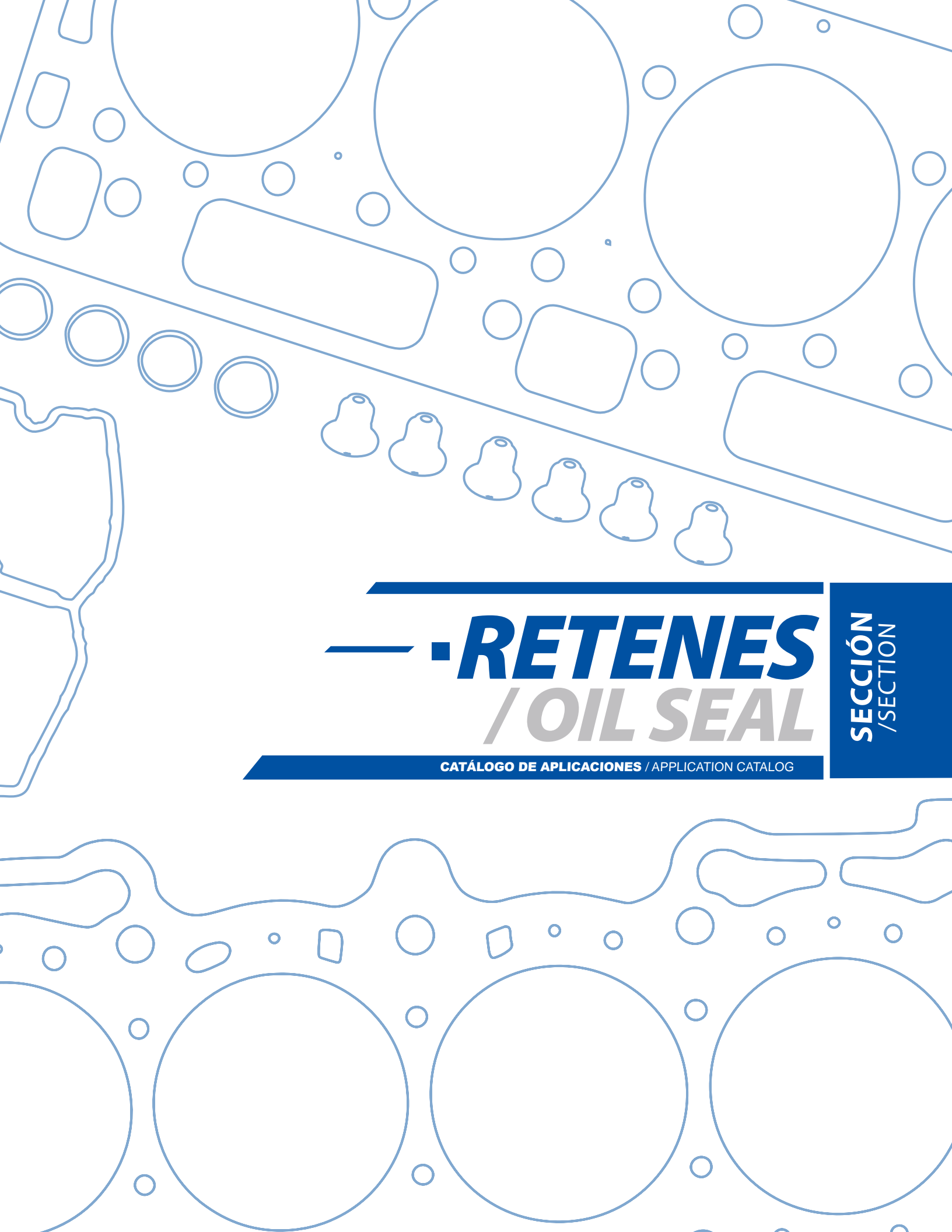

RETENES **/ OIL SEAL**

SECCIÓN
/SECTION

CATÁLOGO DE APLICACIONES / APPLICATION CATALOG



DIÁMETRO EXTERIOR

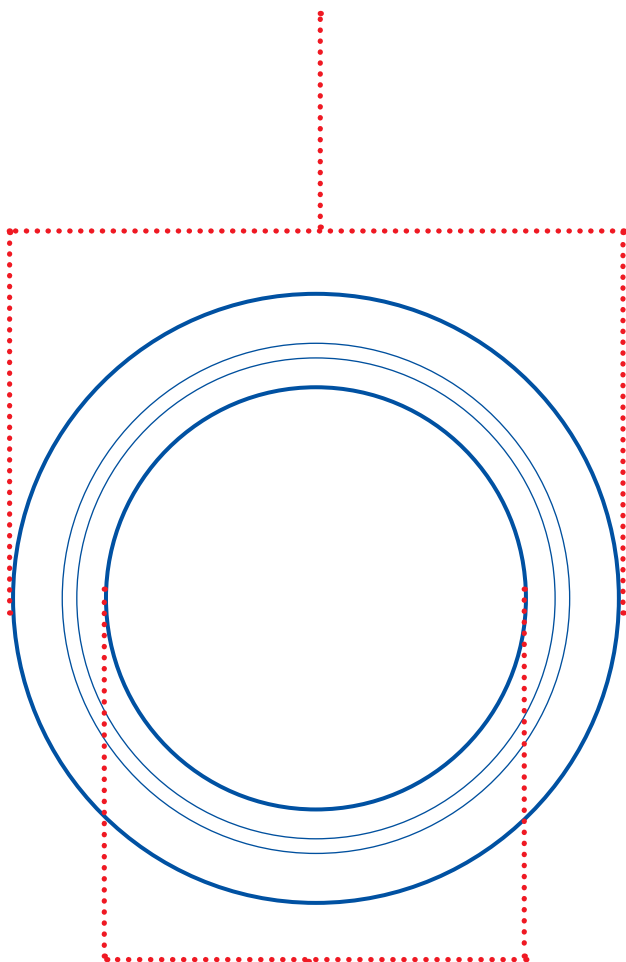

DIÁMETRO INTERIOR

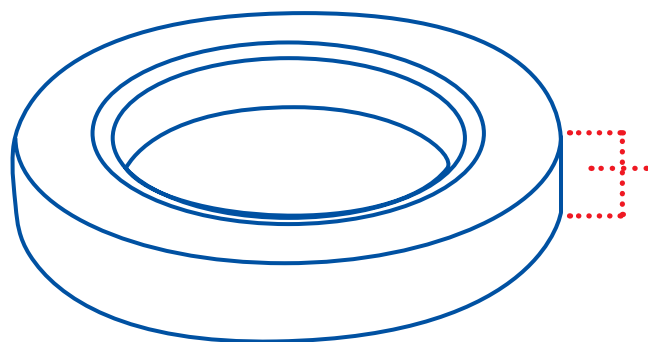

ALTURA



	RE-161550-2		
	DIÁMETRO INTERIOR	DIÁMETRO EXTERIOR	ALTURA
	INSIDE DIAMETER	EXTERNAL DIAMETER	HEIGHT
	0 mm.	43 mm.	9.5 mm.

	RE-16014		
	DIÁMETRO INTERIOR	DIÁMETRO EXTERIOR	ALTURA
	INSIDE DIAMETER	EXTERNAL DIAMETER	HEIGHT
	35 mm.	53.5 mm.	8 mm.

	RE-161550-3		
	DIÁMETRO INTERIOR	DIÁMETRO EXTERIOR	ALTURA
	INSIDE DIAMETER	EXTERNAL DIAMETER	HEIGHT
	0 mm.	57mm.	10.5 mm

	RE-16015		
	DIÁMETRO INTERIOR	DIÁMETRO EXTERIOR	ALTURA
	INSIDE DIAMETER	EXTERNAL DIAMETER	HEIGHT
	35 mm.	52 mm.	8 mm.

	RE-161550		
	DIÁMETRO INTERIOR	DIÁMETRO EXTERIOR	ALTURA
	INSIDE DIAMETER	EXTERNAL DIAMETER	HEIGHT
	28 mm.	42 mm.	6 mm.

	RE-16253-1		
	DIÁMETRO INTERIOR	DIÁMETRO EXTERIOR	ALTURA
	INSIDE DIAMETER	EXTERNAL DIAMETER	HEIGHT
	35 mm.	50 mm.	8 mm.

	RE-16005		
	DIÁMETRO INTERIOR	DIÁMETRO EXTERIOR	ALTURA
	INSIDE DIAMETER	EXTERNAL DIAMETER	HEIGHT
	32 mm.	50 mm.	8 mm.

	RE-16073		
	DIÁMETRO INTERIOR	DIÁMETRO EXTERIOR	ALTURA
	INSIDE DIAMETER	EXTERNAL DIAMETER	HEIGHT
	35 mm.	48 mm.	7 mm.

	RE-16010		
	DIÁMETRO INTERIOR	DIÁMETRO EXTERIOR	ALTURA
	INSIDE DIAMETER	EXTERNAL DIAMETER	HEIGHT
	32 mm.	47 mm.	10 mm.

	RE-161550-1		
	DIÁMETRO INTERIOR	DIÁMETRO EXTERIOR	ALTURA
	INSIDE DIAMETER	EXTERNAL DIAMETER	HEIGHT
	35 mm.	47 mm.	7 mm.

	RE-16116		
	DIÁMETRO INTERIOR	DIÁMETRO EXTERIOR	ALTURA
	INSIDE DIAMETER	EXTERNAL DIAMETER	HEIGHT
	32 mm.	47 mm.	6 mm.

	RE-16110-S		
	DIÁMETRO INTERIOR	DIÁMETRO EXTERIOR	ALTURA
	INSIDE DIAMETER	EXTERNAL DIAMETER	HEIGHT
	35 mm.	49.5 mm.	7 mm.

	RE-16089-R / RE-161229		
	DIÁMETRO INTERIOR	DIÁMETRO EXTERIOR	ALTURA
	INSIDE DIAMETER	EXTERNAL DIAMETER	HEIGHT
	34 mm.	48 mm.	7 mm.

	RE-16313-S1		
	DIÁMETRO INTERIOR	DIÁMETRO EXTERIOR	ALTURA
	INSIDE DIAMETER	EXTERNAL DIAMETER	HEIGHT
	35 mm.	50 mm.	7 mm.



RE-16006		
DIÁMETRO INTERIOR	DIÁMETRO EXTERIOR	ALTURA
INSIDE DIAMETER	EXTERNAL DIAMETER	HEIGHT
36 mm.	49 mm.	9 mm.



RE-16018		
DIÁMETRO INTERIOR	DIÁMETRO EXTERIOR	ALTURA
INSIDE DIAMETER	EXTERNAL DIAMETER	HEIGHT
43.41 mm.	56 mm.	9 mm.



RE-16253		
DIÁMETRO INTERIOR	DIÁMETRO EXTERIOR	ALTURA
INSIDE DIAMETER	EXTERNAL DIAMETER	HEIGHT
37 mm.	50 mm.	6 mm.



RE-16001		
DIÁMETRO INTERIOR	DIÁMETRO EXTERIOR	ALTURA
INSIDE DIAMETER	EXTERNAL DIAMETER	HEIGHT
44.83 mm.	61.26 mm.	9.53 mm.



RE-16007		
DIÁMETRO INTERIOR	DIÁMETRO EXTERIOR	ALTURA
INSIDE DIAMETER	EXTERNAL DIAMETER	HEIGHT
40 mm.	55 mm.	8 mm.



RE-16076-K		
DIÁMETRO INTERIOR	DIÁMETRO EXTERIOR	ALTURA
INSIDE DIAMETER	EXTERNAL DIAMETER	HEIGHT
45 mm.	62 mm.	10 mm.



RE-16077		
DIÁMETRO INTERIOR	DIÁMETRO EXTERIOR	ALTURA
INSIDE DIAMETER	EXTERNAL DIAMETER	HEIGHT
40 mm.	52 mm.	9 mm.



RE-16221-V		
DIÁMETRO INTERIOR	DIÁMETRO EXTERIOR	ALTURA
INSIDE DIAMETER	EXTERNAL DIAMETER	HEIGHT
45 mm.	67 mm.	8 mm.



RE-16317-V		
DIÁMETRO INTERIOR	DIÁMETRO EXTERIOR	ALTURA
INSIDE DIAMETER	EXTERNAL DIAMETER	HEIGHT
40 mm.	62 mm.	7 mm.



RE-161225		
DIÁMETRO INTERIOR	DIÁMETRO EXTERIOR	ALTURA
INSIDE DIAMETER	EXTERNAL DIAMETER	HEIGHT
46 mm.	58 mm.	7 mm.



RE-16031-R		
DIÁMETRO INTERIOR	DIÁMETRO EXTERIOR	ALTURA
INSIDE DIAMETER	EXTERNAL DIAMETER	HEIGHT
42 mm.	56 mm.	7 mm.



RE-16356-N		
DIÁMETRO INTERIOR	DIÁMETRO EXTERIOR	ALTURA
INSIDE DIAMETER	EXTERNAL DIAMETER	HEIGHT
63.65 mm.	47.63 mm.	7.95 mm.



RE-16313-S		
DIÁMETRO INTERIOR	DIÁMETRO EXTERIOR	ALTURA
INSIDE DIAMETER	EXTERNAL DIAMETER	HEIGHT
42 mm.	53 mm.	7 mm.



RE-17001-N		
DIÁMETRO INTERIOR	DIÁMETRO EXTERIOR	ALTURA
INSIDE DIAMETER	EXTERNAL DIAMETER	HEIGHT
121 mm.	159 mm.	15 mm.

** Para ver aplicación dirigirse a catálogo electrónico: catalogo.dcp.com.mx.

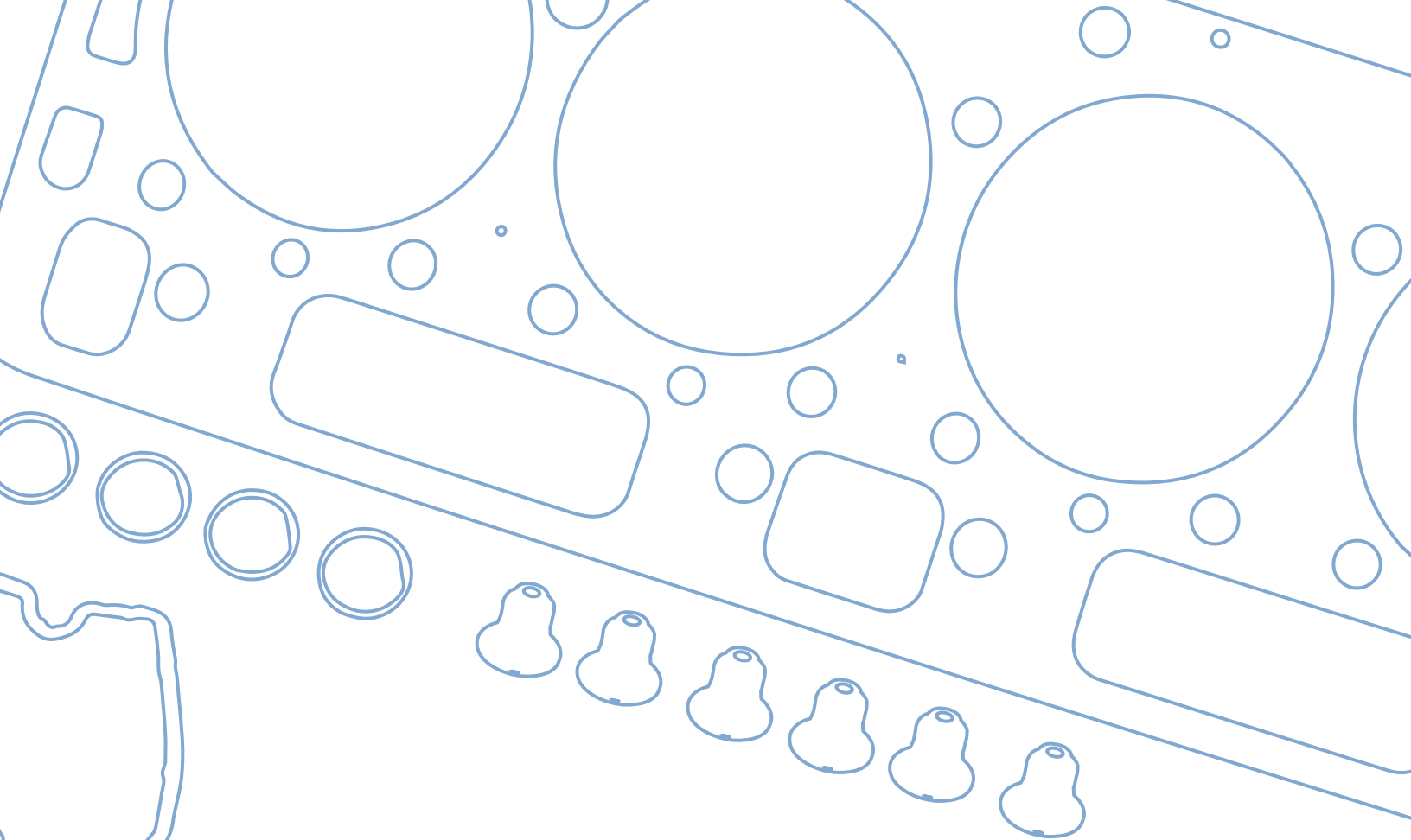

■ ***JUNTAS DE ESCAPE***
/EXHAUST GASKETS

SECCIÓN
/SECTION

CATÁLOGO DE APLICACIONES / APPLICATION CATALOG

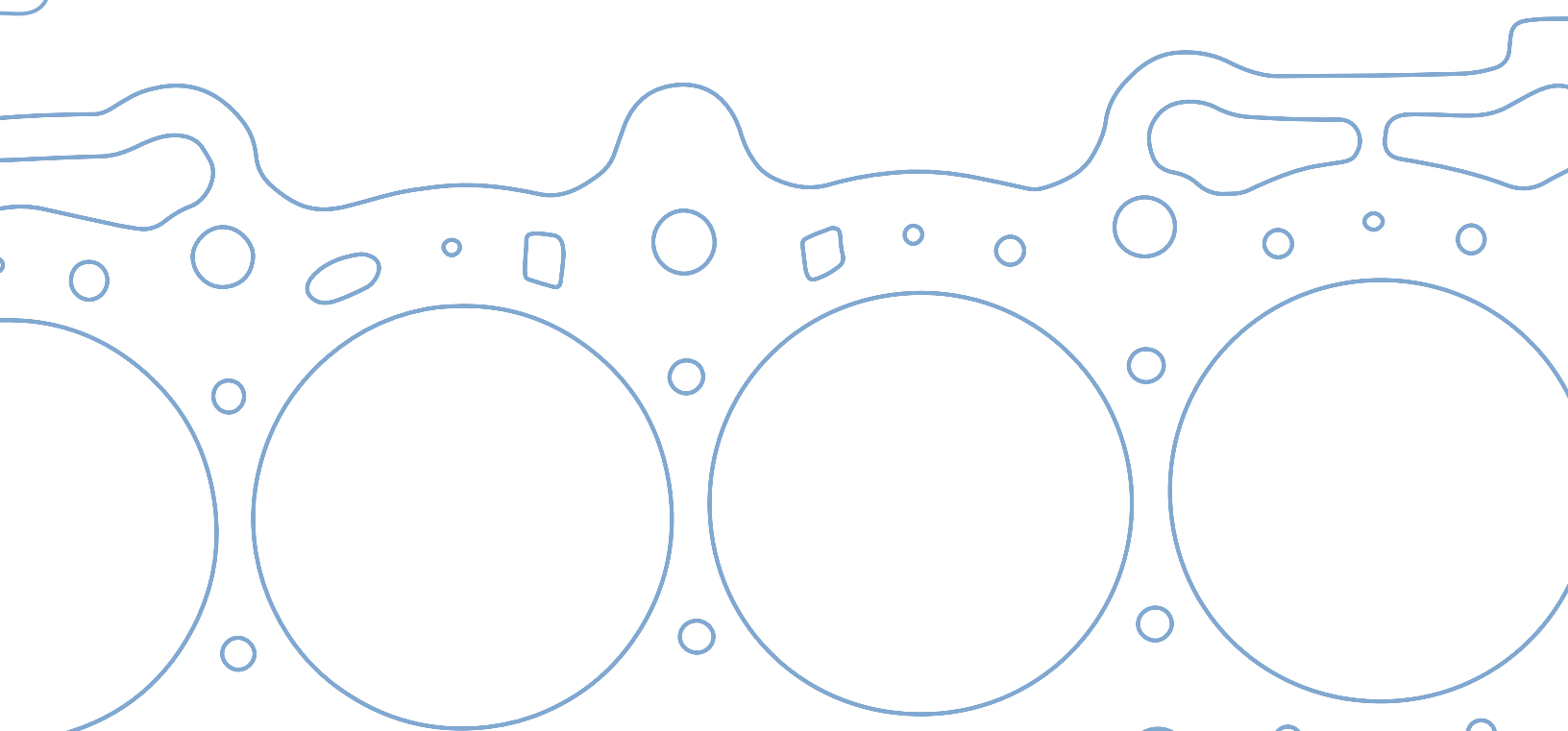



2.5L	MOTOR	MODELOS	DESDE / A
	ENGINE	MODELS	FROM / TO
LA-5105	4L OHV 8V 151" VIN 2 R	CELEBRITY, CITATION, CJ5, CJ7.	1979/1983



2.8L	MOTOR	MODELOS	DESDE / A
	ENGINE	MODELS	FROM / TO
LA-5140	V6 OHV 12V GMC-CHEVROLET	S-10 ,S-15, SONOMA, JIMMY.	1982/1996



2.8L	MOTOR	MODELOS	DESDE / A
	ENGINE	MODELS	FROM / TO
LA-5140-CF	V6 OHV 12V GMC-CHEVROLET	S-10 ,S-15, SONOMA, JIMMY.	1982/1996



3.2L	MOTOR	MODELOS	DESDE / A
	ENGINE	MODELS	FROM / TO
LA-5710	L6 OHV 12V 199"	EAGLE, RAMBLER AMERICAN, PACER, AMBASSADOR, JAVELIN.	1965/1983



3.8L	MOTOR	MODELOS	DESDE / A
	ENGINE	MODELS	FROM / TO
LA-5710	L6 OHV 12V 232"	EAGLE, RAMBLER AMERICAN, PACER, AMBASSADOR, JAVELIN.	1965/1983



4.2L	MOTOR	MODELOS	DESDE / A
	ENGINE	MODELS	FROM / TO
LA-5710	L6 OHV 12V 258"	EAGLE, RAMBLER AMERICAN, PACER, AMBASSADOR, JAVELIN.	1965/1983



4.6L	MOTOR	MODELOS	DESDE / A
	ENGINE	MODELS	FROM / TO
LA-5710	L6 OHV 12V 282"	EAGLE, RAMBLER AMERICAN, PACER, WAGONEER, JAVELIN.	1965/1987





1.0L	MOTOR	MODELOS	DESDE / A
	ENGINE	MODELS	FROM / TO
LB-5201	4L SOHC.12 V G4HC	ATOS.	2000/2003



1.4L	MOTOR	MODELOS	DESDE / A
	ENGINE	MODELS	FROM / TO
LB-5230	4L SOHC 8V MOTOR MITSUBISHI G15B	COLT, MIRAGE, EXCEL.	1979/1991



1.5L	MOTOR	MODELOS	DESDE / A
	ENGINE	MODELS	FROM / TO
LB-5230-1	4L SOHC 12V	COLT, MIRAGE, VISTA	1985/1990



1.5L	MOTOR	MODELOS	DESDE / A
	ENGINE	MODELS	FROM / TO
LB-5230	4L SOHC 8V MOTOR MITSUBISHI G15B	COLT, MIRAGE, EXCEL.	1979/1984



2.0L	MOTOR	MODELOS	DESDE / A
	ENGINE	MODELS	FROM / TO
LA-5242	4L DOHC 16V VIN C, Y	NEON, SEBRING.	1995/1999



2.0L	MOTOR	MODELOS	DESDE / A
	ENGINE	MODELS	FROM / TO
LA-5242-M	4L DOHC 16V VIN C, Y	NEON, SEBRING.	1995/1999



2.0L	MOTOR	MODELOS	DESDE / A
	ENGINE	MODELS	FROM / TO
LB-5243	4L SOHC, DOHC.	NEON, STRATUS, CIRRUS	2000/2007



2.2L	MOTOR	MODELOS	DESDE / A
	ENGINE	MODELS	FROM / TO
LA-5240-G	4L SOHC 8V VIN K C D EXCEPTO TURBO	VOYAGER, DART K, SHADOW, SPIRIT, DAYTONA, LeBARON.	1981/1988





2.2L	MOTOR	MODELOS	DESDE / A
	ENGINE	MODELS	FROM / TO
LA-5240-M	4L SOHC 8V VIN K C D EXCEPTO TURBO	VOYAGER, DART K, SHADOW, SPIRIT, DAYTONA, LeBARON.	1981/1988



2.5L	MOTOR	MODELOS	DESDE / A
	ENGINE	MODELS	FROM / TO
LA-5240-G	4L SOHC 8V VIN K C D EXCEPTO TURBO	VOYAGER, DART K, SHADOW, SPIRIT, DAYTONA, LeBARON.	1981/1988



2.5L	MOTOR	MODELOS	DESDE / A
	ENGINE	MODELS	FROM / TO
LA-5240-M	4L SOHC 8V VIN K C D EXCEPTO TURBO	VOYAGER, DART K, SHADOW, SPIRIT, DAYTONA, LeBARON.	1981/1988



2.8L	MOTOR	MODELOS	DESDE / A
	ENGINE	MODELS	FROM / TO
LB-5220	6L OHV 12V (EXC.ALUMINO)	AUTOS Y CAMIONES	1958/1990



3.0L	MOTOR	MODELOS	DESDE / A
	ENGINE	MODELS	FROM / TO
LB-5253	V6 SOHC 12V MOTOR MITSUBISHI 6G72 MULT. ESCAPE S/DEFLECTOR	CARAVAN, VOYAGER, LeBARON, DYNASTY.	1987/1995



3.7L	MOTOR	MODELOS	DESDE / A
	ENGINE	MODELS	FROM / TO
LB-5200-S	6L OHV	DODGE DART,PICKUP D150,D250	1960/1988



3.7L	MOTOR	MODELOS	DESDE / A
	ENGINE	MODELS	FROM / TO
LB-5200	6L OHV	DODGE DART,PICKUP D150,D250	1960/1988



4.1L	MOTOR	MODELOS	DESDE / A
	ENGINE	MODELS	FROM / TO
LB-5200-S	L6 OHV MOTOR "251"	NEWPORT, TOWN & COUNTRY, WINDSOR	1954/1960





4.1L	MOTOR	MODELOS	DESDE / A
	ENGINE	MODELS	FROM / TO
LB-5200-S	L6 OHV MOTOR "251"	NEWPORT, TOWN & COUNTRY, WINDSOR	1954/1960



4.1L	MOTOR	MODELOS	DESDE / A
	ENGINE	MODELS	FROM / TO
LB-5200	L6 OHV MOTOR "251"	NEWPORT, TOWN & COUNTRY, WINDSOR	1954/1960



4.5L	MOTOR	MODELOS	DESDE / A
	ENGINE	MODELS	FROM / TO
LB-5260	V8 OHV 16V	VALIANT, DART, CHARGER, BARRACUDA, MONACO, CORONET.	1964/1969



5.2L	MOTOR	MODELOS	DESDE / A
	ENGINE	MODELS	FROM / TO
LB-5260	V8 OHV 16V	VALIANT, DART, CHARGER, BARRACUDA, MONACO, CORONET.	1964/1969



5.7L	MOTOR	MODELOS	DESDE / A
	ENGINE	MODELS	FROM / TO
LB-5273	V8 OHV 16V MOTOR HEMI CABEZA DE GRAFITO	300C, CHALLENGER, CHARGER.	2005/2012;





1.6L	MOTOR	MODELOS	DESDE / A	
	ENGINE	MODELS	FROM / TO	
LA-5317	4L SOHC 8V ZETEC ROCAM	FIESTA, IKON, Ka, COURIER.	2001/2010	
1.9L	MOTOR	MODELOS	DESDE / A	
	ENGINE	MODELS	FROM / TO	
LA-5115-M	4L DOHC 16V 116" VIN 7.	SATURN SC, SC2, SL2, SW2.	1991/1995	
1.9L	MOTOR	MODELOS	DESDE / A	
	ENGINE	MODELS	FROM / TO	
LA-5115-G	4L DOHC 16V 116" VIN 7.	SATURN SC, SC2, SL2, SW2.	1991/1995	
2.0L	MOTOR	MODELOS	DESDE / A	
	ENGINE	MODELS	FROM / TO	
LB-5313	4L DOHC 16V	CONTOUR, ESCORT, FOCUS, ZX2.	1995/1997	
2.3L	MOTOR	MODELOS	DESDE / A	
	ENGINE	MODELS	FROM / TO	
LB-5300	4L OHV 8V VIN R S X	TEMPO, TOPAZ.	1984/1994	
2.3L	MOTOR	MODELOS	DESDE / A	
	ENGINE	MODELS	FROM / TO	
LA-5300	4L OHV 8V VIN R S X	TEMPO, TOPAZ.	1984/1994	
2.4L	MOTOR	MODELOS	DESDE / A	
	ENGINE	MODELS	FROM / TO	
LB-5320	6L OHV	FALCON, MAVERICK, CUSTOM ECONO-LINE.	1960/1983	
2.4L	MOTOR	MODELOS	DESDE / A	
	ENGINE	MODELS	FROM / TO	
LA-5320-A	6L OHV	FALCON, MAVERICK, CUSTOM ECONO-LINE.	1960/1983	



2.8L	MOTOR	MODELOS	DESDE / A
	ENGINE	MODELS	FROM / TO
LB-5320	6L OHV (144,170,200,250)	FALCON, MAVERICK, CUSTOM ECONO-LINE,	1960/1972



2.8L	MOTOR	MODELOS	DESDE / A
	ENGINE	MODELS	FROM / TO
LA-5320-A	6L OHV (144,170,200,250)	FALCON, MAVERICK, CUSTOM ECONO-LINE,	1960/1972



2.9L	MOTOR	MODELOS	DESDE / A
	ENGINE	MODELS	FROM / TO
LA-5308	V6 OHV 12V CARB	RANGER, BRONCO II, SCORPIO	1986/1992



3.5L	MOTOR	MODELOS	DESDE / A
	ENGINE	MODELS	FROM / TO
LB-5310	V6 OHV 12V	CUSTOM, WAGON PICK-UP.	1954-1964



3.8L	MOTOR	MODELOS	DESDE / A
	ENGINE	MODELS	FROM / TO
LB-5330	V6 OHV 12 CARB.	COUGAR, THUNDERBIRD	1984/1987



4.0L	MOTOR	MODELOS	DESDE / A
	ENGINE	MODELS	FROM / TO
LB-5335	V6 OHV 12V VIN X	EXPLORER, RANGER.	1990/1994



5.4L	MOTOR	MODELOS	DESDE / A
	ENGINE	MODELS	FROM / TO
LA-5355	V8 OHV 16V (332-)352-360-390-410-427-428	AUTOS Y CAMIONES.	1961/1976



5.8L	MOTOR	MODELOS	DESDE / A
	ENGINE	MODELS	FROM / TO
LB-5365	V8 OHV 16V (351W)	TRUCKS, GALAXIE, GRAND MARQUIS.	1969/1983





1.4L	MOTOR	MODELOS	DESDE / A
	ENGINE	MODELS	FROM / TO
LA-5100	4L SOHC 8V	CHEVY POP, JOY, SWING.	1994/2001



1.6L	MOTOR	MODELOS	DESDE / A
	ENGINE	MODELS	FROM / TO
LB-51310-1	4L DOHC 16V VIN "5"	GEO,PRIZM;CHEVROLET NOVA	1988/1992



1.6L	MOTOR	MODELOS	DESDE / A
	ENGINE	MODELS	FROM / TO
LB-51310-2	4L SOHC	TOYOTA GEO PRIZM	1993/1997



1.8L	MOTOR	MODELOS	DESDE / A
	ENGINE	MODELS	FROM / TO
LB-5122	4L DOHC 16V MOTOR ECOTEC LUW	CRUZE (CABEZA DE GRAFITO).	2011/2013



1.8L	MOTOR	MODELOS	DESDE / A
	ENGINE	MODELS	FROM / TO
LB-5118	4L SOHC 8V	CORSA, PICK-UP TORNADO.	2003/2006



3.0L	MOTOR	MODELOS	DESDE / A
	ENGINE	MODELS	FROM / TO
LA-5161	V6 OHV PONTIAC,BUICK	PARK AVENUE, ELECTRA,SKYLARK	1981/1988



3.0L	MOTOR	MODELOS	DESDE / A
	ENGINE	MODELS	FROM / TO
LA-5142-1	V6 OHV 12V VIN 3	BUICK REGAL, LeSABRE, RIVIERA, CAPRICE, EL CAMINO, PONTIAC BONNEVILLE, CUTLASS.	1982/1985



3.1L	MOTOR	MODELOS	DESDE / A
	ENGINE	MODELS	FROM / TO
LA-5145-1	V6 OHV 12V 189"VIN M J	LUMINA SEDAN, MALIBU.	2000/2003

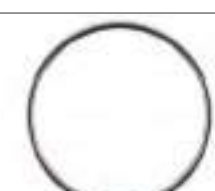



3.1L	MOTOR	MODELOS	DESDE / A
	ENGINE	MODELS	FROM / TO
LA-5145	V6 OHV 12V 189 CID	LUMINA, MONTECARLO, CENTURY.	1993/1996



3.5L	MOTOR	MODELOS	DESDE / A
	ENGINE	MODELS	FROM / TO
LA-5110	6L OHV 12V 216"	BEL AIR, FLEETMASTER, TWO-TEN SERIES, AUTOS Y CAMIONES TODOS.	1937/1953



3.8L	MOTOR	MODELOS	DESDE / A
	ENGINE	MODELS	FROM / TO
LA-5148-G	V6 OHV 12V (231 CID) VIN "K"	CAMARO, FIREBIRD, GRAND PRIX.	1977/2001



3.8L	MOTOR	MODELOS	DESDE / A
	ENGINE	MODELS	FROM / TO
LA-5148-G	V6 OHV 12V 231" VIN K	GRAND PRIX, MONTE CARLO, LUMINA, IMPALA, BONNEVILLE.	1997/2005



3.8L	MOTOR	MODELOS	DESDE / A
	ENGINE	MODELS	FROM / TO
LA-5142	V6 OHV 12V VIN A B C 3 4 6 7 8 9	AUTOS BUICK, CUTLASS, MONTE CARLO, MALIBU.	1977/1982



4.1L	MOTOR	MODELOS	DESDE / A
	ENGINE	MODELS	FROM / TO
LA-5130-G	6L OHV 12V	AUTOS Y CAMIONES CARBURADOS & TBI.	1963/1992



4.2L	MOTOR	MODELOS	DESDE / A
	ENGINE	MODELS	FROM / TO
LA-5153-G	6L DOHC 24V 256" MOTOR VORTEC VIN S	TRAILBLAZER, ENVOY, ASCENDER, BRAVADA (CABEZA DE GRAFITO).	2002/2006



4.3L	MOTOR	MODELOS	DESDE / A
	ENGINE	MODELS	FROM / TO
LA-5144	V6 OHV 12V VIN Z	ASTRO, PICKUP C10, C20, C1500, C2500, SAFARI, CAPRICE, EL CAMINO.	1985/1990





4.3L	MOTOR	MODELOS	DESDE / A	
	ENGINE	MODELS	FROM / TO	
LA-5160-3	V8 OHV VORTEC	CHEYENNE, SUBURBAN, SILVERADO	1996/2009	
4.8L	MOTOR	MODELOS	DESDE / A	
	ENGINE	MODELS	FROM / TO	
LA-5130-G	6L OHV 12V	AUTOS Y CAMIONES CARBURADOS & TBI.	1963/1992	
4.8L	MOTOR	MODELOS	DESDE / A	
	ENGINE	MODELS	FROM / TO	
LA-5160-4	V8 OHV 16V VORTEC	SUBURBAN, AVALANCHE, TRAILBLAZER	1999/2009	
4.8L	MOTOR	MODELOS	DESDE / A	
	ENGINE	MODELS	FROM / TO	
LA-5175	V8 SOHC 16V VORTEC VIN VT	CHEYENNE, SILVERADO 1500, 2500, SUBURBAN, YUKON, SIERRA 1500, 2500, TAHOE (CABEZAS DE GRAFITO).	1999/2001	
5.0L	MOTOR	MODELOS	DESDE / A	
	ENGINE	MODELS	FROM / TO	
LA-5160-1	V8 OHV 16V 305"	CARBURADOS, AUTOS Y CAMIONETAS.	1981/1987	
5.0L	MOTOR	MODELOS	DESDE / A	
	ENGINE	MODELS	FROM / TO	
LA-5160	V8 OHV 16V 305"	AUTOS Y CAMIONES.	1976/1980	



5.0L	MOTOR	MODELOS	DESDE / A
	ENGINE	MODELS	FROM / TO
LA-5160-M	V8 OHV 16V 305"	AUTOS Y CAMIONES.	1976/1980



5.0L	MOTOR	MODELOS	DESDE / A
	ENGINE	MODELS	FROM / TO
LB-5152	V8 OHV 16V (307,337 Y 350 CID)	BLAZER, C10,C10 SUBURBAN	1960-1984



5.3L	MOTOR	MODELOS	DESDE / A
	ENGINE	MODELS	FROM / TO
LA-5175	V8 SOHC 16V VORTEC VIN VT	CHEYENNE, SILVERADO 1500, 2500, SUBURBAN, YUKON, SIERRA 1500, 2500, TAHOE (CABEZAS DE GRAFITO).	1999/2001



5.3L	MOTOR	MODELOS	DESDE / A
	ENGINE	MODELS	FROM / TO
LB-5175	V8 SOHC 16V VORTEC VIN VT	CHEYENNE, SILVERADO 1500, 2500, SUBURBAN, YUKON, SIERRA 1500, 2500, TAHOE (CABEZAS DE GRAFITO).	1999/2001



5.7L	MOTOR	MODELOS	DESDE / A
	ENGINE	MODELS	FROM / TO
LB-5152-1	V8 OHV (307, 348 CID)CHEVROLET	IMPALA, MALIBU, P20 ,P30	1962/1985







5.7L	MOTOR	MODELOS	DESDE / A
	ENGINE	MODELS	FROM / TO
LB-5150	V8 OHV 16V VORTEC MEXICO TBI	MICROBUS, SUBURBAN, C-2500, C-3500, PICK-UP SOLO MEXICO.	1992/1998



6.0L	MOTOR	MODELOS	DESDE / A
	ENGINE	MODELS	FROM / TO
LB-5176	V8 SOHC 16V VORTEC VIN U	SILVERADO 2500, SIERRA 2500, YUKON, EXPRESS VAN,CARGO VAN, SUBURBAN (CABEZA DE GRAFITO).	1999/2000





1.3L	MOTOR ENGINE	MODELOS MODELS	DESDE / A FROM / TO	
LA-51450	4L SOHC 8V D13A1 D13A2 EV1 EV2	CIVIC.	1984/1987	
1.5L	MOTOR ENGINE	MODELOS MODELS	DESDE / A FROM / TO	
LA-51450	4L SOHC 12V D15A3 EW3 EW4	CIVIC.	1984/1991	
1.6L	MOTOR ENGINE	MODELOS MODELS	DESDE / A FROM / TO	
LA-51490	4L SOHC D16YZ,D17A7.	CIVIC	1996/2004	
2.2L	MOTOR ENGINE	MODELOS MODELS	DESDE / A FROM / TO	
LA-51457	4L SOHC 16V F22A4, F22A6, F22A1.	ACCORD, PRELUDE.	1990/1997	

ISUZU

2.0L	MOTOR ENGINE	MODELOS MODELS	DESDE / A FROM / TO	
LA-51110	4L SOHC 8V MOTOR "FE" y "F8"	PICK UP B2000, 626.	1983/1987	



1.6L	MOTOR	MODELOS	DESDE / A
	ENGINE	MODELS	FROM / TO
LA-51112	4L SOHC MAZDA ENGINE	MAZDA 626 ;FORD PROBE (2.2L 89-92)	1995/1998



2.0L	MOTOR	MODELOS	DESDE / A
	ENGINE	MODELS	FROM / TO
LB-51110	4L SOHC 8V MOTOR "FE" y "F8"	PICK UP B2000, 626.	1983/1987





1.5L	MOTOR ENGINE	MODELOS MODELS	DESDE / A FROM / TO	
LB-51216	4L SOHC 8V E15	TSURU I.	1983/1987	
1.6L	MOTOR ENGINE	MODELOS MODELS	DESDE / A FROM / TO	
LB-51216	4L DOHC 16V GA16DE MOTOR JAPONES	TSURU III, TSUBAME, 200SX, SENTRA, LUCINO.	1991/1996	
1.6L	MOTOR ENGINE	MODELOS MODELS	DESDE / A FROM / TO	
LB-51226	4L DOHC 16V GA16DE MOTOR JAPONES	TSURU III, TSUBAME, 200SX, SENTRA, LUCINO.	1991/1996	
1.6L	MOTOR ENGINE	MODELOS MODELS	DESDE / A FROM / TO	
LB-51226-1	4L DOHC 16V GA16DE GA16DNE	TSURU III GSI, GSII, SENTRA MEXICO, TSUBAME.	1997/2014	
1.6L	MOTOR ENGINE	MODELOS MODELS	DESDE / A FROM / TO	
LB-51216	4L SOHC 8V E16	TSURU II.	1984/1992	
1.8L	MOTOR ENGINE	MODELOS MODELS	DESDE / A FROM / TO	
LA-51400	4L DATSUN "J" 1500,1600,1700	DATSUN TODOS	1960/1990	
1.8L	MOTOR ENGINE	MODELOS MODELS	DESDE / A FROM / TO	
LB-51218-1	4L SOHC DATSUN	DATSUN 310,510,610,620	1974/1987	
2.0L	MOTOR ENGINE	MODELOS MODELS	DESDE / A FROM / TO	
LB-51222	4L SOHC 8V Z20E	200SX, PICK UP 510.	1980/1981	



2.0L	MOTOR	MODELOS	DESDE / A
	ENGINE	MODELS	FROM / TO
LB-51218	4L SOHC 8 VALV MOTOR L20B	200SX, PICK UP 720, 710, 620, 510.	1977/1980



2.4L	MOTOR	MODELOS	DESDE / A
	ENGINE	MODELS	FROM / TO
LB-51225	4L SOHC 12V KA24E KA24S	ICHI VAN, PICK-UP D21, ESTAQUITAS.	1990/1998



3.0L	MOTOR	MODELOS	DESDE / A
	ENGINE	MODELS	FROM / TO
LA-51244	V6 OHV NISSAN	MAXIMA, INFINITY I30.	1996/1999



■ RENAULT

1.6L	MOTOR	MODELOS	DESDE / A
	ENGINE	MODELS	FROM / TO
LB-51530	4L OHV	R12, R18, TS.	1975/1984



2.2L
MOTOR
MODELOS
DESDE / A
ENGINE
MODELS
FROM / TO
LB-51310

4L SOHC 8V 20R

CELICA, CORONA, PICK-UP.

1975/1980

3.3L
MOTOR
MODELOS
DESDE / A
ENGINE
MODELS
FROM / TO
LA-51326

V6 DOHC 3MZFE

HIGHLANDER SUV

2004/2007

3.4L
MOTOR
MODELOS
DESDE / A
ENGINE
MODELS
FROM / TO
LA-51357

V6 DOHC 24V 5VZFE.

TACOMA, 4RUNNER, T-100, TUNDRA.

1995/2004





1.2L	MOTOR	MODELOS	DESDE / A
	ENGINE	MODELS	FROM / TO
LB-51810	H4 8V BOXER	SEDAN.	1963/1965



1.2L	MOTOR	MODELOS	DESDE / A
	ENGINE	MODELS	FROM / TO
LB-41810-1	H4 8V BOXER	SEDAN, COMBI	1961/1965



1.7L	MOTOR	MODELOS	DESDE / A
	ENGINE	MODELS	FROM / TO
LB-51830	4L SOHV 8V	CARIBE, ATLANTIC, GOLF	1977/1990



1.8L	MOTOR	MODELOS	DESDE / A
	ENGINE	MODELS	FROM / TO
LB-51840-1	4L SOHC 8V AVH AZG	POINTER, POINTER PICK UP	1998/2002



1.8L	MOTOR	MODELOS	DESDE / A
	ENGINE	MODELS	FROM / TO
LB-51840-2	4L SOHV 8V	POINTER, Y POINTER PICK UP	1998/2004



1.8L	MOTOR	MODELOS	DESDE / A
	ENGINE	MODELS	FROM / TO
LB-41812	H4 OHV 1200,1500,1600,1800	VW SEDAN ,BRASILIA	1968/2000



1.8L	MOTOR	MODELOS	DESDE / A
	ENGINE	MODELS	FROM / TO
LA-51800	H4 OHV 1200,1500,1600,1800	VW SEDAN ,BRASILIA	1965/2000



1.8L	MOTOR	MODELOS	DESDE / A
	ENGINE	MODELS	FROM / TO
LB-51840	4L SOHC 8V CARB & FI	JETTA A2, GOLF, CORSAR, CABRIOLET, RABBIT.	1983/1998





1.8L	MOTOR	MODELOS	DESDE / A	
	ENGINE	MODELS	FROM / TO	
LB-41811	H4 OHV 1200,1500,1600,1800	VW SEDAN ,BRASILIA	1968/2000	
1.8L	MOTOR	MODELOS	DESDE / A	
	ENGINE	MODELS	FROM / TO	
LB-51852	4L DOHC 20V (ADR,AFY,ANB)	PASSAT,BEETLE	1999/2005	
1.8L	MOTOR	MODELOS	DESDE / A	
	ENGINE	MODELS	FROM / TO	
LA-51840	4L SOHC 8V CARB & FI	JETTA A2, GOLF, CORSAR, CABRIOLET, RABBIT.	1983/1998	
2.0L	MOTOR	MODELOS	DESDE / A	
	ENGINE	MODELS	FROM / TO	
LB-51845	4L SOHC 8V ABA	JETTA A3, GOLF, CABRIO.	1993/1999	
2.5L	MOTOR	MODELOS	DESDE / A	
	ENGINE	MODELS	FROM / TO	
LB-51856	5L DOHC 20V	BORA,BEETLE	2005/2010	

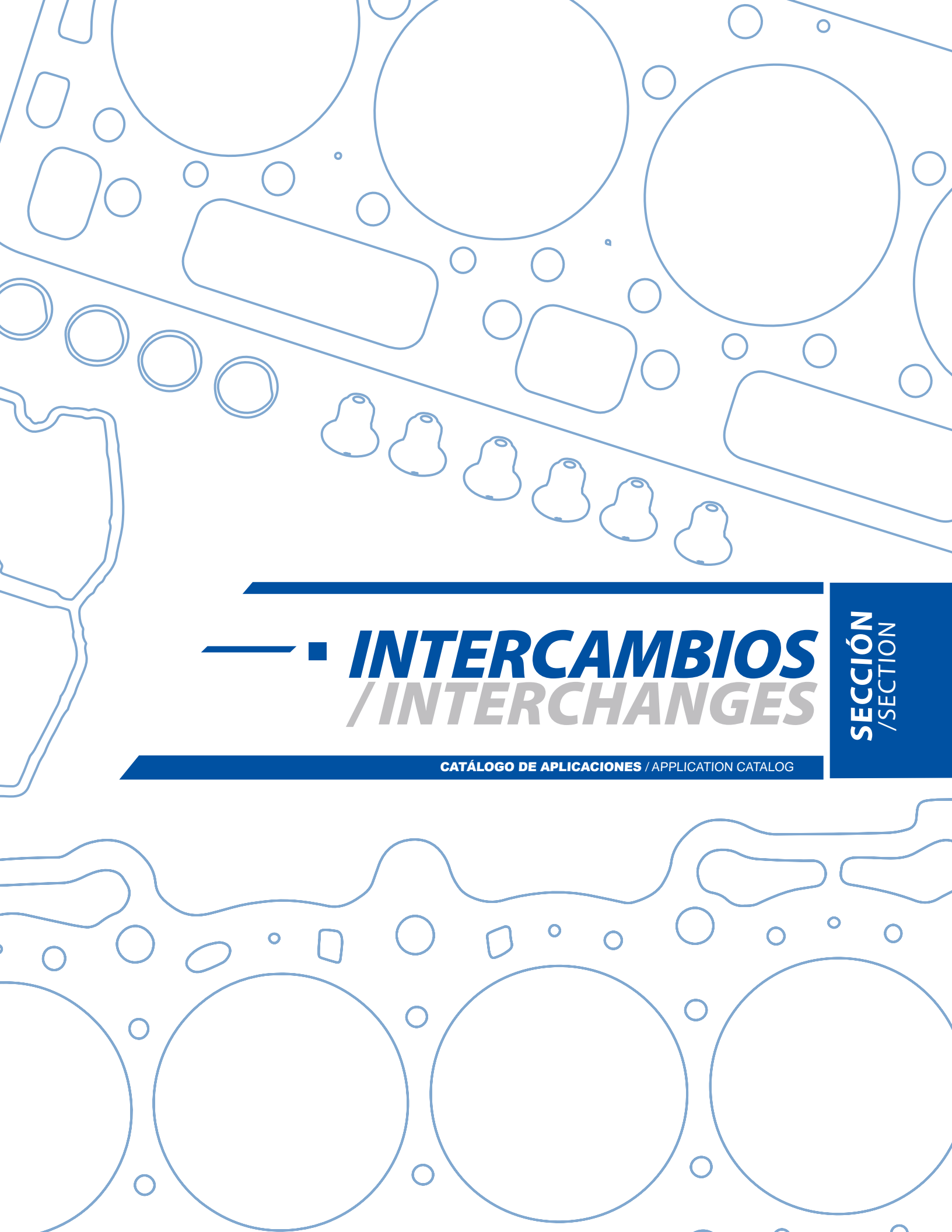

— ■ **INTERCAMBIOS**
/INTERCHANGES

SECCIÓN
/SECTION

CATÁLOGO DE APLICACIONES / APPLICATION CATALOG



■ JUEGOS COMPLETOS / FULL SETS

# TF VICTOR	# FELPRO/MEX	# DC	# TF VICTOR	# FELPRO/MEX	# DC
JC-10	FSHS26255PT	FS-001234-1	JC-1303	FS21187PT1	FS-001310
JC-100	JSE41800	FS-001852	JC-1304	JTO422001	FS-001320
JC-102	JVWB52500	FS-001856-ML	JC-1305	JTO422003	FS-001320-1
JC-112	FSHS26197PT	FS-000203-ML	JC-1306	JTO422002	FS-001320-2
JC-114	JCH415ATT	FS-000204-ML	JC-1308	FSHS26232PT	FS-001326
JC-115	FSHS9388PT1	FS-000202	JC-1403-K	JCH62251	FS-000220-1
JC-1204	JGM420001	FS-000117	JC-1403-K2	JCH62252	FS-000225-1
JC-1205-2	JGM62501	FS-000130	JC-1405	JCH42500	FS-000240-1
JC-1206	JGM6173	FS-000140-1	JC-1406	JCH422002	FS-000240-2
JC-1207	JGM6181	FS-000142-1	JC-1407	FSHS26332PT	FS-000226-ML
JC-1208	JGM631001	FS-000141	JC-1408	JCH420007	FS-000242
JC-1212	JGM422001	FS-000107-1	JC-1408-1	JCH420006	FS-000242-1
JC-1215	JGMC41600	FS-000100-1	JC-1409	JCH63900	FS-000270
JC-1216	JGM41341	FS-000108-2	JC-1410	JCH63300	FS-000254
JC-1216-1	JGM41342	FS-000112-1	JC-1411	JCH424002	FS-000245
JC-1217	JGM41511	FS-000106	JC-1412	JCH63500	FS-000261
JC-1219	JGM41512	FS-000105-2	JC-1413	FS8770PT	FS-000250
JC-1222	JGM6262	FS-000144-1	JC-1414	JCH6181	FS-000253-1
JC-1222-1	JGM62621	FS-000144	JC-1415	JDH100D42500	FS-000206-D
JC-1222-2	FS9354PT1	FS-000144-5	JC-1416	JCH633002	FS-000263
JC-1222-3	FS9354PT2	FS-000144-3	JC-1417	FSHS26229PT	FS-000271
JC-1222-7	JGM64300	FS-000144-7	JC-1417	FSHS26229PT	FS-000271-ML
JC-1223	JGM63100	FS-000145-2	JC-1418	JCH62500	FS-000252
JC-1223-1	JGM631003	FS-000145-1	JC-1419	JCH84700	FS-000272
JC-1225	JGM418003	FS-000118	JC-1419	JCH84700	FS-000272-ML
JC-1228	JGM42000	FS-000117-ML	JC-1420	FSHS26284PT	FS-000273-ML
JC-1229	JGM42200	FS-000113-G	JC-1420	FSHS26284PT	FS-000273
JC-1232	JGM42400	FS-000109-1	JC-1431-1	JCH83182	FS-000260-1
JC-1234	JPO41000	FS-000116	JC-1432-K	JCH83601	FS-000260-2
JC-1239	FSHS26379PT	FS-000102-1G	JC-1434	JCH85900	FS-000275-1
JC-1239	FSHS26379PT	FS-000102-1ML	JC-1434-1	FSHS9898PT2	FS-000275-2
JC-1240	FSHS26336PT	FS-000128-ML	JC-1502-2R	JFO42300	FS-000300
JC-1241	FSHS26390PT	FS-000129-ML	JC-1503-2R	JFO423002	FS-000300-1
JC-1252-1	JGM83502	FS-000150-M	JC-1504	JFO4140	FS-000305
JC-1252-K	JGM8350	FS-000150-5	JC-1504-1	FS9063PT	FS-000306
JC-1253	JGM8305	FS-000160	JC-1505	JFO41600	FS-000303
JC-1254	FSHS26213PT	FS-000153-ML	JC-1505-1	JFO41900	FS-000303-2
JC-1254	FSHS26213PT	FS-000153	JC-1507	JFO420001	FS-000313-1
JC-1258	JGM8454	FS-000167	JC-1508	JFO413FTA	FS-000302
JC-1258	JGM8454	FS-000168-2	JC-1509	JFO41400	FS-000307-ML
JC-1258-1	JGM84541	FS-000168-1	JC-1510	FS7916PT2	FS-000320
JC-1258-1	JGM84541	FS-000169	JC-1510-1	FS7916PT3	FS-000320-1
JC-1259	JGM83503	FS-000150-10	JC-1511	JFO420ECO	FS-000348-1ML
JC-1260-1	JGM63400	FS-000173-1	JC-1511	JFO420ECO	FS-000348-1
JC-1261	FS26168PT	FS-000181	JC-1512-R	JFO6240	FS-000325



■ JUEGOS COMPLETOS / FULL SETS

# TF VICTOR	# FELPRO/MEX	# DC	# TF VICTOR	# FELPRO/MEX	# DC
JC-1512-R	JFO6240	FS-000325-1	JC-1807-K	JAM6282	FS-000710-1
JC-1512-R	JFO6240	FS-000325-3	JC-19	JNI416002	FS-001216
JC-1513-1R	JFO62302	FS-000330-1	JC-20	JNI42400	FS-001225
JC-1513-R	JFO62301	FS-000330	JC-201	JNI4KM	FS-001550-G
JC-1514	JFO638002	FS-000332	JC-201	JNI4KM	FS-001550
JC-1514	JFO638002	FS-000330-2	JC-21	JNI4GA16	FS-001226
JC-1515	JFO63000	FS-000318	JC-22	JNIT41800	FS-001238
JC-1515	JFO63000	FS-000318-1	JC-23	JNI4Z24	FS-001224
JC-1516	JFO6177	FS-000308	JC-25	JNI63000	FS-001229
JC-1518	JFO61712	FS-000315	JC-251	JPE41600	FS-001900
JC-1519	JFO420002	FS-000303-5	JC-26	JNI420002	FS-001228
JC-1520	JFO638003	FS-000332-2	JC-27	JNI42000	FS-001218
JC-1520	JFO638003	FS-000330-4	JC-30	JNIU42400	FS-001232
JC-1520-1	JFO638004	FS-000341	JC-31	FSHS26255PT1	FS-001234
JC-1520-2	JFO638007	FS-000341-1	JC-32	FSCS26192	FS-001229-1
JC-1520-3	JFO638005	FS-000341-2	JC-34	FSHS26261PT	FS-001235-ML
JC-1521	FSHS9539PT1	FS-000303-4	JC-34	FSHS26261PT	FS-001235-G
JC-1522	JFO420004	FS-000348	JC-37	JNIUD63000	FS-001240
JC-1523	JFO416001	FS-000317	JC-38	JNICD42500	FS-001241-ML
JC-1524	FSHS26250PT	FS-000305-9	JC-40	FSHS26372PT	FS-001256-ML
JC-1525	FSHS9081PT1	FS-000335	JC-50	FS9915PT1	FS-001455
JC-1527	FSHS9902PT3	FS-000322-2	JC-50-1	26337PT	FS-001459-ML
JC-1531-K	JFO8352	FS-000355-1	JC-70-2	JGM42500	FS-001420-2
JC-1531-K	JFO8352	FS-000355	JC-90	JVWE52500	FS-001851
JC-1532	FSHS9790PT8	FS-000356-2	JC-91	JVW416	FS-001835-G
JC-1532-1	FSHS9792PT9	FS-000356-2E	JC-92	JVW416002	FS-001830
JC-1533-1R	JFO83023	FS-000360-5	JC-94	JVWP41800	FS-001840-1
JC-1533-T	JFO83021	FS-000362	JC-98-R	JVW416001	FS-001820-1
JC-1535	FSHS9293PT1	FS-000337-G	JC-98-R	JVW416004	FS-001820-1
JC-1535-1	FSHS9293PT2	FS-000337-1ML	JC-99	JVW42000	FS-001845-1
JC-1536	FSHS8548PT14	FS-000360-6	JC-99-1	JVWC42000	FS-001850-ML
JC-1537	JFO83511	FS-000365-1			
JC-1537-1R	JFO83513	FS-000365-3			
JC-1537-R	JFO83512	FS-000365-2			
JC-1538	JFO638008	FS-000341-3			
JC-1539	JFO8400	FS-000370			
JC-1540	FS8265PT3	FS-000375			
JC-1541	JFO8280	FS-000356			
JC-1544	JFO106800	FS-000390			
JC-1544-1	JFO1068001	FS-000390-1			
JC-1545	JFO854001	FS-000356-3ML			
JC-1545	JFO854001	FS-000356-3			
JC-1545-1	JFO854002	FS-000356-4			
JC-1545-2	FSHS26306PT	FS-000357			
JC-1806-K	JAM6258	FS-000710			



■ JUNTAS DE CABEZA / HEAD GASKETS

# TF VICTOR	# FELPRO/MEX	# DC	# TF VICTOR	# FELPRO/MEX	# DC
CA-100	CSE41800	CA-001852-G	CA-1412-I	CCH63500I	CA-000261-G
CA-102	CVWB52500	CA-001856-G	CA-1414	CCH6181	CA-000253-G
CA-115	9388PT	CA-000202-G	CA-1416-1-D	9996PT	CA-000255-1G
CA-1205-K	CGM6250	CA-000130-G	CA-1416-1-I	9997PT	CA-000254-1G
CA-1206	CGM6173	CA-000140-G	CA-1416-D	9536PT	CA-000263-G
CA-1207	8723PT1	CA-000142-G	CA-1416-I	9535PT	CA-000264-G
CA-1208-VC	CGM63100	CA-000141-G	CA-1417	26229PT	CA-000271-G
CA-1211	CAM4151	CA-000105-G	CA-1418	9037PT	CA-000252-G
CA-1212	CGM422001	CA-000107-G	CA-1431	CCH8360	CA-000260-G
CA-1213	CGMC41400	CA-000100-G	CA-1434	CCH85200	CA-000275-G
CA-1216	9170PT1	CA-000108-G	CA-1439	26211PT	CA-000715-G
CA-1222	9354PT1	CA-000144-G	CA-1504	9063PT	CA-000306-G
CA-1223	CGM631001	CA-000145-G	CA-1505	CFO41600	CA-000303-G
CA-1225	CGM418003	CA-000118-G	CA-1508	CFO41300	HG35210
CA-1227	CGMA41800	CA-000114-G	CA-1508	CFO41300	CA-000302-G
CA-1228	CGM420001	CA-000117-G	CA-1509	CFO41400	CA-000307-G
CA-1232	9059PT	CA-000109-G	CA-1510	CFO6200	CA-000320-G
CA-1232	9059PT	CA-000109-1G	CA-1512	CFO6240	CA-000325-G
CA-1234	CPO41000	CA-000116-G	CA-1513	CFO62301	CA-000330-G
CA-1235-D	CGM63800D	CA-000149-G	CA-1514	CFO63800	CA-000332-G
CA-1235-I	9917PT	CA-000148-G	CA-1514	CFO63800	CA-000331-1G
CA-1250-VC	CGM8350	CA-000150-G	CA-1515	CFO63000	CA-000318-G
CA-1253	CGM8305	CA-000160-G	CA-1516-D	9510PT	CA-000309-G
CA-1254	26213PT	CA-000153-G	CA-1516-I	9511PT	CA-000308-G
CA-1254	26214PT	CA-000153-G	CA-1518-D	9132PT	CA-000316-G
CA-1258-1	CGM84541	CA-000169-G	CA-1518-I	9136PT	CA-000315-G
CA-1260	9071PT	CA-000173-G	CA-1519	9539PT	CA-000303-1G
CA-1261-D	26169PT	CA-000181-G	CA-1520-D	9253PT	CA-000342-G
CA-1261-I	26168PT	CA-000182-G	CA-1520-I	9250PT	CA-000341-G
CA-1262	26191PT	CA-000175-G	CA-1523	CFO416001	CA-000317-G
CA-1262	9292PT	CA-000175-G	CA-1524	26250PT	CA-000305-G
CA-1264	26192PT	CA-000176-G	CA-1527-D	CFO6183D	CA-000323-G
CA-1301	26185PT	CA-001320-GX	CA-1527-I	CFO6183I	CA-000322-G
CA-1301	26185PT	CA-001320-GX1	CA-1531-K	CFO8352	CA-000355-G
CA-1301	26185PT	CA-001320-G	CA-1535-I	26301PT	CA-000337-G
CA-1309	9465PT	CA-001352-G	CA-1539	CFO8400	CA-000370-G
CA-1309	9465PT	CA-001330-G	CA-1540	8558PT1	CA-000375-G
CA-1401	26206PT	CA-000245-1G	CA-1540	8558PT1	CA-000380-G
CA-1406	CCH42500	CA-000240-G	CA-1541-D	9790PT2	CA-000357-G
CA-1408	9922PT	CA-000242-G	CA-1541-I	9792PT2	CA-000356-G
CA-1409	9910PT	CA-000270-G	CA-1544-D	26305PT	CA-000391-G
CA-1410-D	CCH63300D	CA-000255-G	CA-17	CNI416001	CA-001210-G
CA-1410-I	CCH63300I	CA-000254-G	CA-18	CNI41800	CA-001215-G
CA-1411	9924PT	CA-000245-G	CA-1806-VC	CAM6258	CA-000710-G
CA-1412-D	CCH63500D	CA-000262-G	CA-1807-VC	CAM6282	CA-000710-G

■ JUNTAS DE CABEZA / HEAD GASKETS

# TF VICTOR	# FELPRO/MEX	# DC	# TF VICTOR	# FELPRO/MEX	# DC
CA-19-G	CNI416002	CA-001216-G	CA-1411	9924PT	CA-000242-1ML
CA-20	CNI42400	CA-001225-G	CA-1416-1-D	9996PT	CA-000263-ML
CA-201	CNI4KM	CA-001550-G	CA-1416-1-I	9997PT	CA-000264-ML
CA-21	9819PT	CA-001226-G	CA-1417	26229PT	CA-000271-ML
CA-22	CNIT41800	CA-001238-G	CA-1419	26157PT	CA-000272-ML
CA-22	CNIT41800	CA-001238-GX	CA-1438-D	26208PT	CA-000268-1ML
CA-23	9210PT1	CA-001224-G	CA-1438-I	26209PT	CA-000268-ML
CA-23	9210PT1	CA-001224-GX	CA-1439	26211PT	CA-000715-ML
CA-24	8769B2	CA-001222-G	CA-1506	9717PT	CA-000303-2ML
CA-25	9571PT	CA-001229-G	CA-1509	CFO41400	CA-000307-ML
CA-26	9816PT	CA-001228-G	CA-1517-D	9038PT	CA-000311-ML
CA-27	21178PT	CA-001218-G	CA-1517-I	9039PT	CA-000312-ML
CA-30	CNIU42400	CA-001232-G	CA-1519	9539PT	CA-000303-1ML
CA-32	26219PT	CA-001229-1G	CA-1520-D	9253PT	CA-000342-ML
CA-33	26171PT	CA-001233-G	CA-1520-I	9250PT	CA-000341-ML
CA-34	26261PT	CA-001235-GX	CA-1526-D	26212PT	CA-000327-ML
CA-34	26261PT	CA-001235-G	CA-1526-I	26233PT	CA-000326-ML
CA-50	9915PT	CA-001455-G	CA-1535-I	26301PT	CA-000337-ML
CA-50-1	26236PT	CA-001459-G	CA-1544-D	26305PT	CA-000391-ML
CA-50-2	9274PT	CA-001454-G	CA-1544-I	26304PT	CA-000356-ML1
CA-51-1	9958PT1	CA-001463-GX	CA-1544-I	26304PT	CA-000390-ML
CA-51-1	9958PT1	CA-001463-G	CA-1545-D	26307PT	CA-000357-ML
CA-54	26243PT	CA-001466-G	CA-1545-I	26306PT	CA-000356-ML
CA-70-VC	CGM42100	CA-001420-G	CA-203	CRN42000	CA-001555-ML
CA-85-G	CRE41300	CA-001520-G	CA-22	CNIT41800	CA-001238-ML
CA-91	CVW416	CA-001835-G	CA-251	CPE41600	CA-001900-ML
CA-92-G	CVW416002	CA-001830-G	CA-34	26261PT	CA-001235-ML
CA-95	CVO62800	CA-001854-G	CA-35-D	26240PT	CA-001236-1ML
CA-99	9570PT	CA-001845-G	CA-35-D	26240PT	CA-001239-ML
CA-99-1	26161PT	CA-001850-G	CA-35-I	26239PT	CA-001239-1ML
CA-100	CSE41800	CA-001852-ML	CA-35-I	26239PT	CA-001236-ML
CA-102	CVWB52500	CA-001856-ML	CA-37-GR1	CNIUD6300065	CA-001243-ML
CA-112	26197PT	CA-000203-ML	CA-50	9915PT	CA-001455-ML
CA-113	26224PT	CA-000204-ML	CA-50-1	26236PT	CA-001459-ML
CA-1227	CGMA41800	CA-000114-ML	CA-50-2	9274PT	CA-001454-ML
CA-1229	CGM42200	CA-000113-ML	CA-51-1	9958PT1	CA-001463-ML
CA-1254	26213PT	CA-000153-ML	CA-54	26243PT	CA-001466-ML
CA-1254	26214PT	CA-000153-ML	CA-91	CVW416	CA-001835-ML
CA-1264	26192PT	CA-000176-ML	CA-99	9570PT	CA-001845-ML
CA-1308	26232PT	CA-001328-ML	CA-99-1	26161PT	CA-001850-ML1
CA-1401	26206PT	CA-000245-1ML	CA-99-1	26161PT	CA-001850-ML
CA-1401	26206PT	CA-000245-ML			
CA-1407	26332PT	CA-000226-ML			
CA-1408	9922PT	CA-000242-1ML			
CA-1408-2	9036PT	CA-000242-ML			



■ MULTIPLES / MANIFOLD GASKETS

# TF VICTOR	# FELPRO/MEX	# DC	# TF VICTOR	# FELPRO/MEX	# DC
MU-4100-A	MS96151	MS-041852-A	MU-41259-A	MS90131	MS-004150-9
MU-4100-A	MS96151	MS-041852-1A	MU-41259-E	MS94054	MS-004150-3E
MU-4100-E	MS96116	MS-041852-E	MU-41261-E	MS96057	MS-004181-E
MU-4102-A	MS97007	MS-041856-A	MU-41262-E	MS92467	MS-004175-E
MU-4102-E	MS97034	MS-041856-E	MU-41262-E	MS92467	MS-004152-E
MU-4112-E	MS96162	MS-004203-1E	MU-41303-E	MS90832	MS-041310-E
MU-4113-A	MS96331	MS-004203-A	MU-41305-E	MS91679	MS-041320-E
MU-4113-E	MS96332	MS-004203-E	MU-41307-A	MS93942	MS-041302
MU-4113-E	MS96332	MS-004204-E	MU-41308-A	MS94295	MS-041325
MU-4115-A	MS929641	MS-004235	MU-41308-E	MS941401	MS-041325-E
MU-4115-E	MS94841	MS-004235-E	MU-41309-A	MS92692	MS-041330
MU-41205	MGM6250	MS-004130-1	MU-41309-E	MS92721	MS-041330-E
MU-41206	MGM6173A	MS-004140-A	MU-41309-E	MS92721	MS-041330-LSE
MU-41206-E	MGM6173E	MS-004140-E	MU-41401-A	MS92888	MS-004245-2
MU-41207-E	MS90508	MS-004142-1E	MU-41401-A	MS92888	MS-004245-1
MU-41208-A	MGM63100A	MS-004141-A	MU-41401-E	MS92846	MS-004245-1E
MU-41208-E	MGM63100E	MS-004141-E	MU-41403-K	MCH6225	MS-004220
MU-41212-A	MS90543	MS-004107-1	MU-41407-A	MS96840	MS-004226-A
MU-41212-E	MS90540	MS-004107-E	MU-41407-E	MS96902	MS-004226-E
MU-41212-E	MS90540	MS-004117-1E	MU-41408-1A	MS90708	MS-004243-3P
MU-41213-E	MGM41400E	MS-004100-E	MU-41408-2E	MS95674	MS-004243-E
MU-41216-A	MS95393	MS-004108-1	MU-41408-2E	MS95674	MS-004243-1E
MU-41216-E	MGM4121E	MS-004108-E	MU-41409-A	MS95315	MS-004270
MU-41222-7-A	MS95817	MS-004144-4	MU-41410-1-A	MS928081	MS-004254-A
MU-41222-7-A	MS95817	MS-004144-5	MU-41410-E	MS94666	MS-004254-E
MU-41222-7-E	MS95842	MS-004144-1E	MU-41411-A	MCH42400A	MS-004242
MU-41223-1A	MS90565	MS-004145-1	MU-41411-A	MCH42400A	MS-004242-1P
MU-41223-1P	MS90562	MS-004145-1P	MU-41411-A	MCH42400A	MS-004243-2P
MU-41223-1P	MS90562	MS-004145-1	MU-41411-S	MCH424001A	MS-004242-1P
MU-41223-E	MS95586	MS-004145-E	MU-41412-A	MS95444	MS-004261
MU-41232-A	MS95839	MS-004109-1NS	MU-41412-A	MS95444	MS-004261-1
MU-41232-E	MS90278	MS-004109-E	MU-41412-E	MS95446	MS-004268-E
MU-41232-E	MS90284	MS-004109-E	MU-41412-E	MS95446	MS-004262-E
MU-41235-A	MS958091	MS-004148-NS1	MU-41414-A	MS93795	MS-004253-1
MU-41235-A	MS958091	MS-004149-2NS	MU-41414-E	MS93797	MS-004253-E
MU-41235-E	MS95829	MS-004148-E	MU-41414-E	MS93797	MS-004253-2E
MU-41235-P	MS95746	MS-004148-P	MU-41415-AE	MDH100D42500A	MS-004206-D
MU-41250-E	MGM8350E	MS-004150-E	MU-41417-A	MS932051	MS-004271
MU-41252-1-A	MGM83501A	MS-004150-6	MU-41417-E	MS96344	MS-004271-E
MU-41254-E	MS96302	MS-004153-E	MU-41418-P	MS95708	MS-004252-P
MU-41254-E	MS96707	MS-004153-E	MU-41419-A	MS93205	MS-004272
MU-41258-1A	MS95826	MS-004169	MU-41419-E	MS93217	MS-004272-E
MU-41258-1E	MS95840	MS-004169-E	MU-41420-A	MS96574	MS-004273
MU-41258-1P	MS95787	MS-004169-P	MU-41432-A	MCH8360A	MS-004260-1
MU-41259-A	MS90131	MS-004150-8	MU-41432-E	MCH8360E	MS-004260-E



■ MULTIPLES / MANIFOLD GASKETS

# TF VICTOR	# FELPRO/MEX	# DC	# TF VICTOR	# FELPRO/MEX	# DC
MU-41432-E	MCH8360E	MS-004261-E	MU-41520-P	MS95934	MS-004341-1P
MU-41434-1A	MS953921	MS-004275-1	MU-41521-A	MS94432	MS-004303-3
MU-41434-1A	MS953921	MS-004275-3	MU-41521-A	MS94432	MS-004303-3NS
MU-41434-A	MS95392	MS-004275	MU-41521-E	MS94427	MS-004313-1E
MU-41438-A	MS92165	MS-004261-2	MU-41524-A	MS96634	MS-004305-1
MU-41438-A	MS92165	MS-004261-2LS	MU-41524-E	MS96655	MS-004305-2P
MU-41438-A	MS92165	MS-004261-3	MU-41525-A	MS98005T	MS-004335-A
MU-41438-A	MS92165	MS-004261-3LS	MU-41525-E	MS94764	MS-004335-E
MU-41438-P	MS91990	MS-004261-2	MU-41526-A	MS925861	MS-004327
MU-41438-P	MS91990	MS-004261-3LS	MU-41526-A	MS925861	MS-004327-6
MU-41438-P	MS91990	MS-004261-3	MU-41527-A	MS953721	MS-004318
MU-41438-P	MS91990	MS-004261-3P	MU-41531	MFO8352A	MS-004355-A
MU-41438-P	MS91990	MS-004261-2LS	MU-41531-E	MS9812	MS-004355-E
MU-41438-P	MS91990	MS-004261-2P	MU-41533-1A	MFO8351A	MS-004361-A
MU-41502	MFO42300E	MS-004300	MU-41533-1A	MFO8351A	MS-004365-2
MU-41503-A	MFO423002A	MS-004300-1	MU-41533-1A	MFO8351A	MS-004361
MU-41504-1A	MS91617	MS-004306	MU-41533-1A	MFO8351A	MS-004361-2
MU-41505	MFO4116E	MS-004303	MU-41533-A	MFO8302A	MS-004360-A
MU-41505-1-A	MS93935	MS-004301-2	MU-41533-A	MFO8302A	MS-004362
MU-41507-A	MS90891	MS-004313-1	MU-41533-E	MFO8302E	MS-004360-E
MU-41507-E	MS95702	MS-004313-E	MU-41535-1A	MS96123	MS-004337-A
MU-41513-1A	MFO62301A	MS-004330-1	MU-41535-E	MS90779	MS-004337-E
MU-41513-E	MFO6230E	MS-004330-E	MU-41535-E	MS90779	MS-004337-LSE
MU-41514-A	MS940451	MS-004330-4	MU-41536-P	MS95953	MS-004360-3P
MU-41514-I	MFO62302A	MS-004330-2	MU-41538-E	MS95528	MS-004341-E
MU-41515-A	MFO63000A	MS-004318	MU-41541-1A	MS94801	MS-004357
MU-41515-E	MFO63000E	MS-004318-E	MU-41541-E	MFO8280E	MS-004357-E
MU-41515-E	MFO63000E	MS-004318-1E	MU-41544-1A	MS940141	MS-004390-1
MU-41516-A	MS93771	MS-004308-A	MU-41544-A	MS940121	MS-004390
MU-41516-E	MS93849	MS-004308-E	MU-41544-A	MS940121	MS-004390-1S
MU-41517-A	MS95726	MS-004311	MU-41544-E	MS941081	MS-004390-E
MU-41517-A	MS95726	MS-004327-2NS	MU-41545-1A-D	MS962811	MS-004357-2
MU-41517-E	MS95715	MS-004311-E	MU-41545-1A-D	MS962811	MS-004357-NS2
MU-41518-A	MS91886	MS-004315	MU-41545-A	MFO85400A	MS-004357-NS1
MU-41518-E	MFO61712E	MS-004315-E	MU-41545-A	MFO85400A	MS-004357-1
MU-41519-A	MS95918	MS-004303-2	MU-41545-P	MFO854001A	MS-004356-1P
MU-41520-1P	MS90812	MS-004341-2P	MU-41545-P	MFO854001A	MS-004356-NSP
MU-41520-A1-D	MS959851	MS-004341-1	MU-416	MNI41600	MS-041215
MU-41520-A1-D	MS959851	MS-004341-NS1	MU-416	MNI41600	MS-041200
MU-41520-A-D	MS95985	MS-004341-6	MU-41806	MAM6258	MS-004711
MU-41520-A-D	MS95985	MS-004341	MU-41806	MAM6258	MS-004710
MU-41520-A-D	MS95985	MS-004341-NSC	MU-419-1	MNI416002A	MS-041216-1E
MU-41520-A-D	MS95985	MS-004341-NS	MU-419-E	MNI416002E	MS-041216-E
MU-41520-P	MS95934	MS-004341-NSC	MU-420-E	MNI42400E	MS-041225-E
MU-41520-P	MS95934	MS-004341-6	MU-421-E	MS96343	MS-041226-E



■ MULTIPLES / MANIFOLD GASKETS

■ JUNTAS TAPA DE PUNTERÍAS / VALVE COVER GASKETS

# TF VICTOR	# FELPRO/MEX	# DC
MU-421-E	MS96343	MS-041234-E
MU-422-A	MNI4Z22A	MS-041222
MU-422-A	MNI4Z22A	MS-041238
MU-422-E	MS90978	MS-041238-E
MU-423-A	MS93691	MS-041224-1
MU-425-A	MS922701	MS-041229-A
MU-425-E	MS92271	MS-041229-E
MU-426-E	MS96113	MS-041228-E
MU-427-1	MS226931	MS-041218
MU-431-A	MS96514	MS-041234
MU-432-A	MS922704	MS-041229
MU-433-A	MS954591	MS-041233-A
MU-434-A	MS96536	MS-041235-A
MU-434-E	MS96539	MS-041235-E
MU-435-A	MS96454	MS-041236-A
MU-435-E	MS91459	MS-041236-E
MU-490-A	MVWGL2500A	MS-041851
MU-490-E	MVWDP41000E	MS-041851-E
MU-492-A	MVW416002A	MS-041830-A
MU-492-A	MVW416002A	MS3880
MU-492-E	MVW416002E	MS-041830-E
MU-493	MVW41800A	MS-041840
MU-495-E	MS91963	MS-041854-E
MU-499-1-E	MS94356	MS-041845-1E

# TF VICTOR	# FELPRO/MEX	# DC
PS-310	VS50618R	VS-031234-1R
PS-3100	VS50531R	VS-031852-R
PS-3102	VS50735R	VS-031856-R
PS-3111	PCH41000	VS-003201-R
PS-3112	VS50575R	VS-003203-R
PS-3113	VS50593R	VS-003204-R
PS-3115	VS50132R	VS-003235-R
PS-31205	PGM6250	VS-003130
PS-31206	PGM6173	VS-003140-R
PS-31206	PGM6173	VS-003140
PS-31208	PGM63100	VS-003141-R
PS-31208	PGM63100	VS-003141-S
PS-31212	VS50485R	VS-003107
PS-31213	PGM41400	VS-003100
PS-31216	VS50313R	VS-003108-R
PS-31222	VS50086R	VS-003144-R
PS-31222-7	VS50464R	VS-003144-1R
PS-31223	VS50442R	VS-003145-R
PS-31235	VS50080R	VS-003148-R
PS-31250	PGM8350	VS-003150
PS-31250	PGM8350	VS-003150-R
PS-31254	VS50484R	VS-003153-R
PS-31258-1	VS50388R	VS-003168-R
PS-31259	VS50088R	VS-003150-1R
PS-31261	VS50554R	VS-003181-R
PS-31262	VS50504R	VS-003175-R
PS-31262	VS50504R	VS-003152-R
PS-31308	VS50530R	VS-031325-R
PS-31309	VS50512R	VS-031330-R
PS-31401	VS50518R	VS-003245-R
PS-31403	PCH62251C	VS-003220
PS-31403-1	PCH62252C	VS-003225
PS-31404	VS50257C	VS-003240
PS-31405	PCH42500	VS-003240-1
PS-31406	PCH422001	VS-003240-S
PS-31406	PCH422001	VS-003240-2R
PS-31407	VS50698R	VS-003226-R
PS-31408	VS50457R	VS-003242
PS-31408	VS50457R	VS-003242-HD
PS-31408-1	PCH420004	VS-003242-R
PS-31409	VS50420R	VS-003270-HD
PS-31409	VS50420R	VS-003270
PS-31409	VS50420R	VS-003265-1R
PS-31410	PCH63300	VS-003254-HD
PS-31410	PCH63300	VS-003254-1R

■ JUNTAS TAPA DE PUNTERÍAS / VALVE COVER GASKETS

# TF VICTOR	# FELPRO/MEX	# DC	# TF VICTOR	# FELPRO/MEX	# DC
PS-31410-1	VS50599R	VS-003254-R	PS-31533	PFO8302R	VS-003360-HD
PS-31411	VS50459R	VS-003243-R	PS-31533	PFO8302R	VS-003360-R
PS-31412	VS50429R	VS-003261-HD	PS-31533-G	VS50029C	VS-003360-G
PS-31412	VS50429R	VS-003261-LR	PS-31535-1	VS50529R	VS-003337-2R
PS-31414	VS50026R1	VS-003253-R	PS-31535-D	VS50491R	VS-003337-1R
PS-31415	PDH100D42500	VS-003206-RD	PS-31539	PFO8400	VS-003370
PS-31416-1	VS50315R	VS-003254-3R	PS-31541-D	VS50377R	VS-003356-R
PS-31416-1	VS50315R	VS-003254-2R	PS-31543	VS50474R	VS-003375-1R
PS-31417-D	VS50594R	VS-003271-R	PS-31545-D	VS50481R	VS-003357-R
PS-31418	VS50461R	VS-003252-R	PS-316	PNI416001	VS-031210
PS-31419-D	VS50577R	VS-003272-R	PS-31806	VS50186C	VS-003710
PS-31420	VS50625R	VS-003273-R	PS-319	PNI416002	VS-031216-1R
PS-31431	PCH8360C	VS-003260-R	PS-319	PNI416002	VS-031216-R
PS-31431	PCH8360C	VS-003260	PS-319	PNI416002	VS-031216
PS-31431	PCH8360C	VS-003260-HD	PS-319	PNI416002	VS-031216-1
PS-31434	PCH85200	VS-003275-HD	PS-320	VS50042R	VS-031225
PS-31434	PCH85200	VS-003275	PS-320	VS50042R	VS-031225-R
PS-31434-1	VS50419R	VS-003275-R	PS-321	VS50383R	VS-031226-R
PS-31438	VS50689R	VS-003268-R	PS-321	VS50383R	VS-031226
PS-31438	VS50689R	VS-003261-2	PS-323	VS50246R	VS-031222
PS-31439	VS50458R	VS-003715-1R	PS-324-1	VS50343C	VS-031222-1
PS-31439	VS50522T	VS-003715-1R	PS-325	VS50251R1	VS-031229-R
PS-31503	PFO423002	VS-003300-1	PS-326	VS50384R	VS-031228-R
PS-31504-1	PFO4140	VS-003305	PS-327	PNI420001	VS-031218
PS-31505	VS50476R	VS-003303	PS-333-1	VS50385R	VS-031233-R
PS-31507	VS50460R	VS-003313-R	PS-334	VS50623R	VS-031235-R
PS-31507-1	VS50489R	VS-003313-1R	PS-335-D	VS50608R	VS-031236-R
PS-31510	VS12692	VS-003320	PS-354	VS50614R	VS-031466-1R
PS-31513	PFO62301	VS-003330	PS-354	VS50614R	VS-031466-R
PS-31514	VS50321R	VS-003330-1R	PS-370	PGM42100	VS-031420
PS-31514	VS50321R	VS-003330-1S	PS-392	PVW416002	VS-031830
PS-31515	PFO6183	VS-003318-1R	PS-394	VS50528R	VS-031840-R
PS-31515-1	VS50374R	VS-003318-R	PS-395	VS50643R	VS-031854-R
PS-31515-1	VS50374R	VS-003318	PS-396	PVW416001	VS-031810-1
PS-31516	VS50312C	VS-003308-R	PS-396	PVW416001	VS-031810
PS-31516	VS50312C	VS-003308			
PS-31517-D	VS50462R	VS-003311-R			
PS-31518	VS50115C	VS-003315			
PS-31520	VS50441R1	VS-003330-2R			
PS-31520	VS50441R1	VS-003330-3R			
PS-31521	VS50553R	VS-003313-3R			
PS-31522	VS50638R	VS-003348-R			
PS-31525	VS50368C	VS-003335			
PS-31525	VS50368C	VS-003335-1R			
PS-31533	PFO8302R	VS-003360			



■ SELLOS DE CIGÜEÑAL / CRANK SEAL

# TF VICTOR	# FELPRO/MEX	# DC
CO-91205-2SL	RGM8350	BS-007150-R
CO-91205-2SL	RGM8350	BS-007130-2
CO-91205-2SL	RGM8350	BS-007150
CO-91403-1KNT	RCH62251	BS-007220-R
CO-91403-KAS	BS40489	BS-007220
CO-91409-VT	BS40181	BS-007270-R
CO-91432-KPL	RCH8360	BS-007260
CO-91432-KPL	RCH8360	BS-007256-R
CO-91432-KPL	RCH8360	BS-007260-R
CO-91432-KPL	RCH8360	BS-007275-R
CO-91524-KAS	BS40651	BS-007256
CO-91524-KAS	BS40651	BS-007265
CO-91533-PL	RFO8302	BS-007321
CO-91533-PL	RFO8302	BS-007321-R
CO-91537-PL	RFO8351	BS-007370
CO-91537-PL	RFO8351	BS-007370-R
CO-91806-NT	RAM6258	BS-007710

■ JUNTAS DE CARTER / OIL PAN SET

# TF VICTOR	# FELPRO/MEX	# DC
CJ-11206	AGM6173	OS-001140
CJ-11208	OS34501R	OS-001140-1R
CJ-11208	OS34501R	OS-001140-1S
CJ-11213	AGM41400	OS-001100
CJ-11216	AGM4134	OS-001108
CJ-11222	OS34502R	OS-001144-R
CJ-11222	OS34502R	OS-001144
CJ-11222-7	OS30680R	OS-001144-1R
CJ-11223	OS30668R	OS-001145-R
CJ-11232	OS30678R	OS-001109-1
CJ-11235	OS30767R	OS-001148-R
CJ-11250	AGM83502	OS-001150
CJ-11250	AGM83502	OS-001160
CJ-11258-1	AGM8454	OS-001168-R
CJ-11259	AGM83503	OS-001150-1R
CJ-11259	AGM83503	OS-001150-R
CJ-11261	OS30714R	OS-001181-R
CJ-11262	OS30693R	OS-001175-1R
CJ-11262	OS30693R	OS-001175
CJ-11262	OS30693R	OS-001152
CJ-11301	OS20102C	OS-011310
CJ-11404	ACH42200	OS-001240
CJ-11405	ACH42500R	OS-001240-1S
CJ-11405	ACH42500R	OS-001240-1R
CJ-11405	ACH42500R	OS-001240-1C
CJ-11408	OS30673R	OS-001242-R
CJ-11408	OS30673R	OS-001242-HD
CJ-11409	OS34503R	OS-001270-R
CJ-11410-1	OS30622R	OS-001254-R
CJ-11411	OS30676R	OS-001245-HD
CJ-11412	OS30692R	OS-001261-R
CJ-11414	OS30570C	OS-001253
CJ-11415	ADH100D42500	OS-001250
CJ-11417	OS30743R	OS-001271-R
CJ-11418	OS30672C	OS-001252
CJ-11419	OS30709R	OS-001272-R
CJ-11420	OS30750R	OS-001273-1R
CJ-11432	ACH8360	OS-001256-3
CJ-11434	ACH83601	OS-001275-R
CJ-11439	OS34308R	OS-001715-R
CJ-115	ANI416001	OS-011200
CJ-11502	AFO42300	OS-001300
CJ-11502	AFO42300	OS-001300-2
CJ-11504-1	OS30297C	OS-001305
CJ-11505-1	OS30915R	OS-001303-2R



■ JUNTAS DE CARTER / OIL PAN SET

# TF VICTOR	# FELPRO/MEX	# DC
CJ-11505-1	OS30915R	OS-001303-1R
CJ-11507	OS30908C	OS-001313-R
CJ-11513	OS34000C	OS-001330
CJ-11513	OS34000C	OS-001330-1
CJ-11517	AFO62500	OS-001326-R
CJ-11518	OS30271C	OS-001315
CJ-11521	OS30711R	OS-001313-1R
CJ-11524	OS30814R	OS-001305-3R
CJ-11527-1	OS30712R	OS-001318-2R
CJ-11533	AFO8302	OS-001360
CJ-11536	OS34508R	OS-001360-1R
CJ-11537	AFO8351	OS-001365
CJ-11539	AFO8400	OS-001370
CJ-11544	OS30710R	OS-001390
CJ-11806	AAM6258	OS-001710
CJ-119	ANI416002	OS-011216
CJ-120	ANI42400	OS-011225
CJ-121	OS30619C	OS-011226
CJ-123	OS20042C	OS-011218
CJ-150	OS30691R	OS-011455-2R
CJ-150-1	OS30690R	OS-011459-R
CJ-150-1	OS30690R	OS-011455-1R
CJ-170-X	OS30409C	OS-011420-1
CJ-170-X	OS30409C	OS-011420
CJ-192	AVW416002	OS-011830
CJ-192	AVW416002	OS-011830-R

■ JUNTAS DE DISTRIBUCIÓN / TIMING COVER

# TF VICTOR	# FELPRO/MEX	# DC
DJ-81205	DGM6250	TC-006130
DJ-81206	DGM6173	TC-006140
DJ-81208	DGM63100	TC-006140-1
DJ-81216	TCS45793	TC-006108
DJ-81250	DGM8350	TC-006150-5
DJ-81403-X	TCS127691	TC-006220
DJ-81410	TCS458931	TC-006254
DJ-81410	TCS458931	TC-006254-1
DJ-81431	DCH8360	TC-006256
DJ-81434	TCS45996	TC-006270
DJ-81502	DFO42300	TC-006300
DJ-81513	DFO62302	TC-006330
DJ-81513	DFO62302	TC-006330-1
DJ-81516	TCS45791	TC-006308
DJ-81517	TCS45966	TC-006311
DJ-81533	DFO8302	TC-006360
DJ-81539	TCS45061	TC-006370
DJ-81541	TCS45869	TC-006356
DJ-81544	TCS45982	TC-006357
DJ-81544	TCS459821	TC-006357
DJ-81806	TCS45117	TC-006710
DJ-819	TCS45524	TC-061216
DJ-821	TCS45864	TC-061226

■ JUNTAS DE CARBURADOR / CARBURATOR GASKET

# TF VICTOR	# FELPRO/MEX	# DC
CR-902	FP902	DC-000902
CR-906	FP906	DC-000906
CR-919	FP919	DC-000919
CR-920	FP920	DC-000920
CR-924	FP924	DC-000924

CATÁLOGO / CATALOG 2017

www.dcp.com.mx

VENTAS

• Tel. (477) 710 60 00
• Lada sin costo 01 (800) 710 50 20
ventas@dcp.com.mx

CUSTOMER SERVICE

USA CONTACT: Toll Free • 1 877 676 7704
Phone • 321 221 0443
• email: cs@dcp.com.mx
FUERA DE MÉXICO: (52) 477 7106007

SERVICIO TÉCNICO / TECHNICAL SERVICE:

477 710 60 00
email: soportetecnico@dcp.com.mx

MANUFACTURAS DIVERSAS S.A. de C.V.

