





# Strong Set XL

with Monolith Desk + Round Table





 (704) 339-0785

 [support@tvsetdesigns.com](mailto:support@tvsetdesigns.com)

 @tvsetdesigns

 /tvsetdesigns

 #tvsetdesigns

 808 Tuckaseegee Road, Charlotte, NC 28208



## Strong Set XL

The Strong XL is great for moderate to large sized studios. The XL means there are extra frames and another column, giving you the versatility to film at multiple angles. Use the larger section for a news desk and then easily switch cameras to another presenter or round table discussion on the opposite side.





# Planning and Design



## Design Time

Our Planning and Design Service gives you one-on-one time with a designer to make your vision a reality. They work with you to dial in the details and then create 3D renderings. This provides the opportunity to try different looks before construction and means there are no surprises upon delivery.

In your quote Design is itemized by the day or week. One, 8-hour day of Design is \$1,152. This includes two rendered revisions per day of Design. Standard sets usually take one, 40-hour week billed at \$5,760. A week of design allows for up to 10 revisions.

Design services are cumulative. Your 8-hour day of design can span multiple business days. This gives you space to share renderings internally and make changes without any pressure.

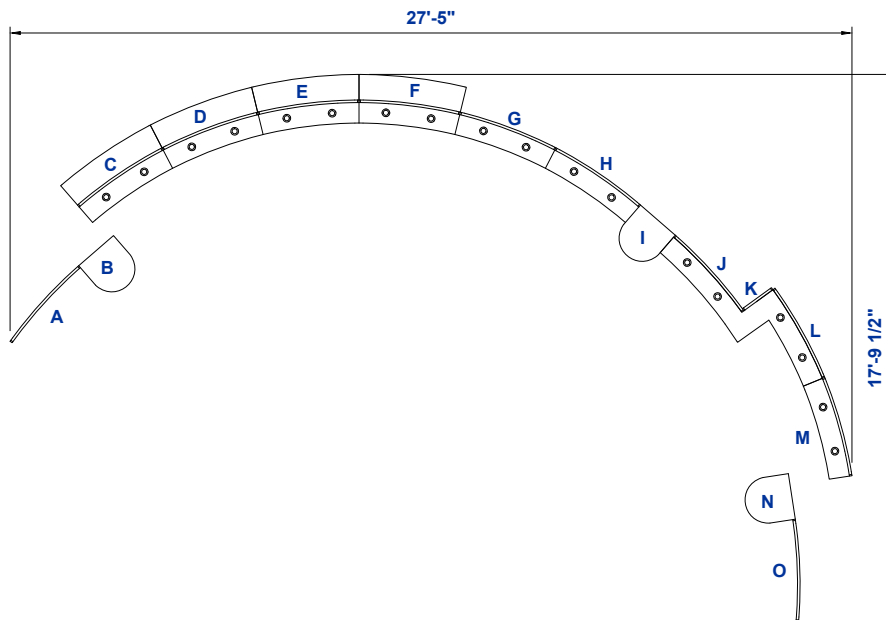

## Planning and design includes:

- Zoom or conference calls to plan with your team.
- Communicating via Basecamp to easily share images, documents, and comments from project start to delivery.
- Reviewing your budget, studio size, and timeline. This includes reviewing blueprints and preliminary drawings.
- Determining studio usage—Will it be a news show, interview panel, or both? What are your studio's limitations and opportunities?
- Exploring what products you like or dislike. What look and feel do you want?
- Selecting materials and samples—we offer lots of options for colors, finishes, graphics panels, textures, and other features.
- Rendering a 3D model and make revisions to finalize the design.
- Documenting all the fabrication specifications for your approval.
- Talking with the shop to problem solve any build challenges and ensure the finished product reflects your design.

## Strong Set XL

If you're going XL, make it big and bold. Color changing lights + large scale graphics make a strong statement. Do you want something big in size but not as bright? All the laminate finishes are custom selected for each set. With all of our projects, the laminate and translucent finishes are included in the price of the frames. This photo shows 9' frames and RGBW lit columns. Ask us about pricing for 8' or 10' tall version.

The Monolith News Desk and Round Table News Desk are priced separately but look absolutely fantastic on this set. As pictured the Monolith News Desk with RGBW edge lighting is \$16,479 with freight. The Round Table News Desk with two-zone RGBW lighting is \$11,833 with freight.







**TVsetdesigns.com LLC**  
 808 Tuckaseegee Road  
 Charlotte, NC 28208-4435

Voice:704-339-0785 Fax:704-339-0545  
 support@tvsetdesigns.com

# Quote

<b>Date</b>	<b>Estimate #</b>
1/1/2024	SSXa24

**Billing Company Name / Address:**

**EXAMPLE QUOTE ONLY**  
**DO NOT SUBMIT A P.O.**  
**ALL QUOTES ARE JOB SPECIFIC**



<b>Customer Phone</b>	<b>Customer E-mail</b>	<b>Terms</b>	<b>PO Number</b>
	support@tvsetdesigns.com		

Description	Qty	Rate	U/M	Total
Project to build a XL Strong Set based on Beacon Academy Approx 28'W x 18'D x 9'H				
<b>FRAMES AND COLUMNS</b>				
Curve Wall Frame 40"x108" with Laminate/Vinyl/Polycarbonate Skin	11	1,670.00	ea	18,370.00
Flat Wall Frame 14"x108" with Laminate/Vinyl/Polycarbonate Skin	1	1,368.00	ea	1,368.00
1/2 Round Column 18"x108" with Polycarbonate/Vinyl/Laminate Skin	3	2,000.00	ea	6,000.00
<b>SPECIALTY SKINS</b>				
Frontlit Graphic - 40"x60" 1/8" styrene sign board or laminate	7	470.00	ea	3,290.00
<b>SET LIGHTING</b>				
Curved Header, each section 3" tall x 40" wide x 8" deep, includes White LED light fixtures pointing up and/or down	9	1,210.00	ea	10,890.00
Flat Header, each section 3" tall x 14" wide x 8" deep, no light fixtures	1	363.00	ea	363.00
Bounce Box Kit 40"W x 95"/108"/119"H Bounce Box, RGBW LED light bar, and cables (Fixture sits on floor)(Divider every 40")	4	1,312.00	ea	5,248.00
Column Light Kit, RGBW LED par light, DMX and power cables	3	422.00	ea	1,266.00
Multi-channel DMX Controller	1	324.00	ea	324.00
Subtotal before freight				47,119.00
<b>FREIGHT</b>				
Ship 6-12 Wall Frames with Crating - Approx 128"L X48"W X 49"H 520 lbs	1	1,509.00	ea	1,509.00
Ship Set Columns with Crating - Approx 128"L X 24"W X 49"H 420 lbs	1	1,142.00	ea	1,142.00
Ship Long Headers, Lights, Misc - Approx 128"L X 24"W X 49"H 420 lbs	1	1,142.00	ea	1,142.00
Shipped via LTL furniture class freight **Client provides unloading and install labor Quotes for installation or dedicated truck delivery are available upon request				

This pricing will be honored until the end of the calendar year that the quote was issued. All freight is LTL service and the client is responsible for unloading and installation unless otherwise indicated above. Image use rights are the responsibility of the end user.	<b>Total</b>
---	--------------



**TVsetdesigns.com LLC**  
 808 Tuckaseegee Road  
 Charlotte, NC 28208-4435

Voice:704-339-0785 Fax:704-339-0545  
 support@tvsetdesigns.com

# Quote

<b>Date</b>	<b>Estimate #</b>
1/1/2024	SSXa24

**Billing Company Name / Address:**

EXAMPLE QUOTE ONLY  
 DO NOT SUBMIT A P.O.  
 ALL QUOTES ARE JOB SPECIFIC



<b>Customer Phone</b>	<b>Customer E-mail</b>	<b>Terms</b>	<b>PO Number</b>
	support@tvsetdesigns.com		

Description	Qty	Rate	U/M	Total
<p>Typical production time for this project is 8-12 weeks depending on complexity of final design. Construction does not begin until payment has been received, all design decisions have been approved, and finishes have been selected</p> <p>Payment Terms: Fabrication - 50% Non-refundable deposit due to begin construction. Final deposit payment due upon completion of construction prior to shipping or installation date            In lieu of deposit payments, POs are accepted only from state or federal school districts, collegiate/university institutions, and U.S. government organizations</p> <p>Please note that sales tax may be added at the time of invoicing. If we do not receive the appropriate exemption or resale certificate, we must charge tax in certain states            Total sales tax calculated by AvaTax            Pricing good through 12/31/2024</p> <p>NOTE: Each set is customized to the space and budget of the client. The number of design days needed will be determined by the amount of customization and the complexity of the set</p> <p>Design services will be added at the time of quoting</p> <p>OPTIONS AS SEEN IN SET PHOTO            Large Monolith with edge lighting and freight            \$16,479            48" Round Table Desk with dual-zone edge lighting and freight            \$11,833</p>		0.00		0.00

This pricing will be honored until the end of the calendar year that the quote was issued. All freight is LTL service and the client is responsible for unloading and installation unless otherwise indicated above. Image use rights are the responsibility of the end user.	<b>Total</b>		<b>\$50,912.00</b>
---	--------------	--	--------------------

# Additional Example

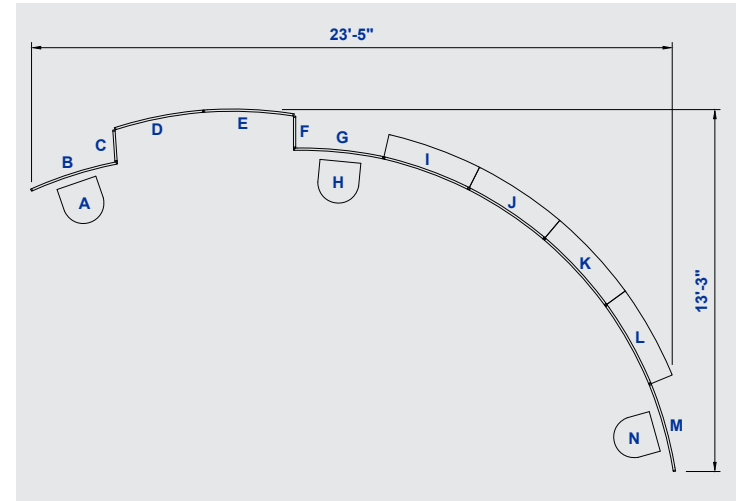

## Simplified & Inverted

This 10' tall Strong Set XL is reconfigured and simplified but still looks electric. All the lighting elements are adjustable to be any color of the rainbow.

### Options:

- Bounce Boxes for RGBW lit translucent panels
- Backlit Graphics (Shown in renderings)
- Round Columns with RGBW lighting

**Desk \$13,640** with freight

**Table \$11,833** with freight **Set \$33,268** with freight