

# CONVERTIBLE BENCH UNITS

 HEAVY-DUTY

 VERSATILE

 COMPACT





# CONVERTIBLE BENCH IN USE



AUDITORIUM



**1 BENCH** with  
**3 SYSTEM**  
Configurations

TESTING



DINING



*Adaptable for your  
Cafeteria, Auditorium  
and Testing Center!*



## Easy Set-up, Ganging, And Storage



### Features



Create One Large Table By Combining Single Bench Units, Using the Built-in Ganging Devices.



Non-Marring Reinforced Nylon Glides With Steel Inserts Installed Over Leg Uprights.



"Pinch-Proof" Feature: Bench Does Not Touch the Top When Folding.



Under Table Hat Supports 1000 Lbs. Weight Capacity. (CBG96 Only)



4 Easy Lock 3" Double Ball-Bearing Heavy-Duty Casters.



Industrial-Grade 14-Gauge Square Tubing Legs and 16-Gauge Aprons.

### Standard Lengths

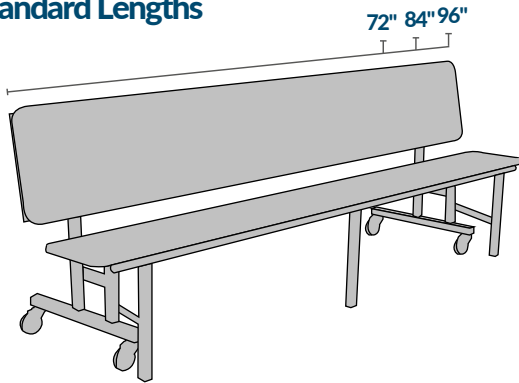

Model #	Seats	Table WxL	Folded Dimensions	Table-Seat Height (Standard)	Table-Seat Height (Custom)
CBG72	3-4	29"x72"	72"x12"x34"	29"-17"	25"-13"
CBG84	4-5	29"x84"	84"x12"x34"	29"-17"	27"-15"
CBG96	4-6	29"x96"	96"x12"x34"	29"-17"	32"-20"

### Tabletops



[View our Laminate and Edge Design Options](#)

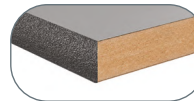

**MDF with Protect Edge**  
.75" Core | HPL Surface  
Protect Edge  
(MD PE)



**Plywood with 3mm PVC Edge**  
.75" Core | HPL Surface  
3mm Hot-Melt PVC Edge  
(PW EB)



**Particleboard with T-Molding**  
.75" Core | HPL Surface  
T-molding  
(PB TM)

### Bench/Table Heights

**13"/25"**  
code: 25

**15"/27"**  
code: 27

**17"/29"**  
standard

**20"/32"**  
code: 32

For non-standard heights add code to end of model number



**24 HOUR QUICK SHIP**

CBG96-MDPEPCGY (96"L, MDF Core, Black Protect Edge, Grey Nebula Back and Bench)



### Model Number Configuration

Model Number | Core | Frame | Bench Laminate

**CBG96 - PW PE PC CH GY**

Edge | Back Laminate

## Standard Edges *No minimum required*



Vinyl T-Molding | Black (TM)



Protect Edge | Black (PE)



3MM PVC Edge Banding | Black (EB)

## Premium Edges *Subject to minimum quantity and upcharge*

VINYL T-MOLD



Beige (TB)



Green (TG)



Light Grey (TL)



Medium Grey (TE)



Navy (TN)



Red (TR)



Silver (TS)



Brown (TO)

PROTECT EDGE



Navy (PN)



Green (PG)



Red (PR)



Purple (PP)



Beige (PB)



Dark Grey (PD)



Medium Grey (PM)



Light Grey (PL)

3MM PVC EDGE BANDING



Navy (EN)



Green (EG)



Red (ER)



Purple (EP)



Beige (EE)



Dark Grey (ED)



Medium Grey (EM)





Light Grey (EL)

## Custom Logo Options

*Upcharge and extended lead times apply*



## Standard Laminates *No minimum required*

 Robin RN	 Port PO	 Regimental Red RR	 Hollyberry RE	 Candy Apple CD	 Orange Grove OG	 Maroochy Brush MB
 Marigold YW	 Sprout SU	 Island IS	 Hunter Green GR	 Morrocan MA	 Ocean OC	 Persian Blue BL
 Lapis Blue LB	 Catalina CI	 Indigo IN	 Atlantis AT	 Brittany Blue BB	 Woolamai Brush WO	 Navy Legacy NL
 Eggplant EP	 Concord Grape CG	 Black BK	 Graphite Nebula GN	 Asian Night AN	 Rustic Slate RS	 Forged Steel FS
 Figured Mahogany MY	 Coffee Bean CB	 Mantana Walnut WT	 Windswept Bronze WZ	 Pinnacle Walnut PN	 Windsor Mahogany WM	 Lowell Ash LA
 Burnished Chestnut CT	 Buka Bark KB	 River Cherry RC	 Nepal Teak NT	 Wild Cherry CH	 Fonthill Pear FP	 Harvest Maple HM
 New Age Oak NW	 Monticello Maple MP	 Bannister Oak OK	 Castle Oak CO	 Limber Maple LM	 Kensington Maple KS	 Fusion Maple FM
 Manitoba Maple MT	 Almond Leather AL	 Tawny Legacy TL	 Natural Almond NA	 Desert Zephyr DZ	 Natural Tigris NG	 Natural Nebula NN
 Steel Mesh SL	 Slate Grey SG	 Mystic Night MN	 Pewter Brush PB	 Windswept Pewter WP	 Twilight Zephyr TZ	 Boardwalk Oak BD

## Standard Laminates

*No minimum required*



Pewter Mesh  
PW



Green Tigris  
GT



Dove Grey  
DG



Sheer Mesh  
SM



Crisp Linen  
CL



High Rise  
HR



Frosty White  
FW



White Sand  
WS



Titanium EV



Carbon Ev  
CE



Tailored Linen  
TA



North Sea  
NS



Pressed Linen  
LN



Cloud Nebula  
CN



Evening Tigris  
ET



Bronze Legacy  
BZ



Nickel  
NE



Pearl Soapstone  
PS



Grey Glace  
GG



Grey Nebula  
GY



Platinum  
PL



Fashion Grey  
GF



White Nebula  
WN



White Tigris  
TW



Grey  
RG



Grey Pampas  
PP

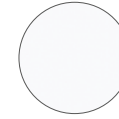

Designer White  
DW

## Premium Laminates

*Subject to minimum quantity and upcharge*



Marmalade  
ML



Quince  
QN



Wheat Berry  
BY

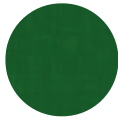

Kale Leaf  
KL



Blue Curacao  
CR



Biltmore Cherry  
BC



Williamsburg Cherry  
WC



Xanadu  
XD



Skyline Walnut  
SW



Charcoal Velvet  
CV



Deepstar Agate  
DS



White Cypress  
CY



White Driftwood  
WD

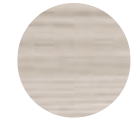

Grey Elm  
GE



Portico Teak  
PT



Italian Silver  
Ash IA



Cosmic Strandz  
CS



Ink Vesta  
IV



Gold Alchemy  
GA

**IF YOU DON'T SEE A  
LAMINATE, JUST ASK!**

**Choose any laminates from:**

*May be subject to minimum quantity and upcharge*

