

# LUXOR

INNOVATIVE WORKSPACE PRODUCT SOLUTIONS

## Parts List

\* # of bins and depth of bins vary by unit ordered



A x8 pcs



B x2 pcs

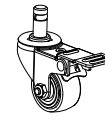

C x2 pcs

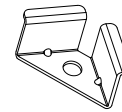

D x4 pcs



E x4 pcs

07/22/16

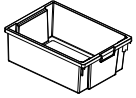

\*F

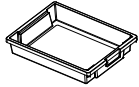

\*G



H x1 pcs



J x4 pcs

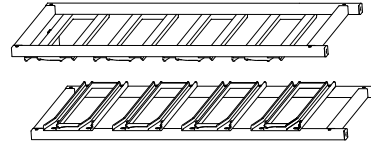

K x2 pcs

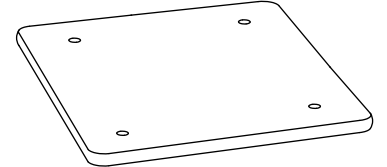

L x1 pcs

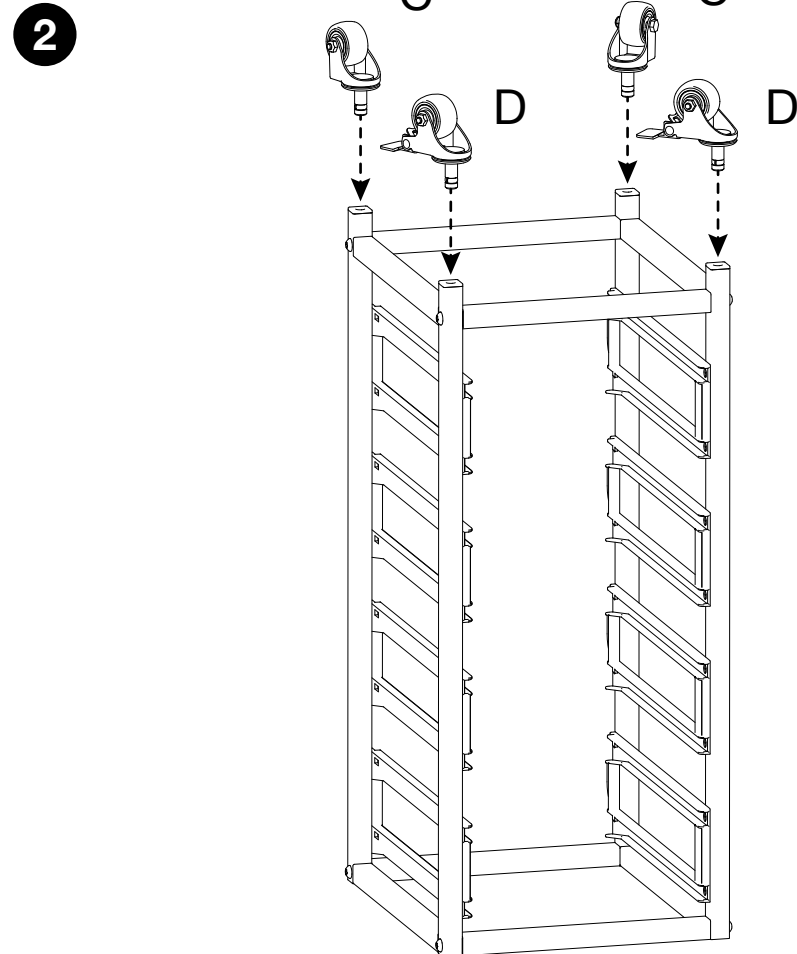
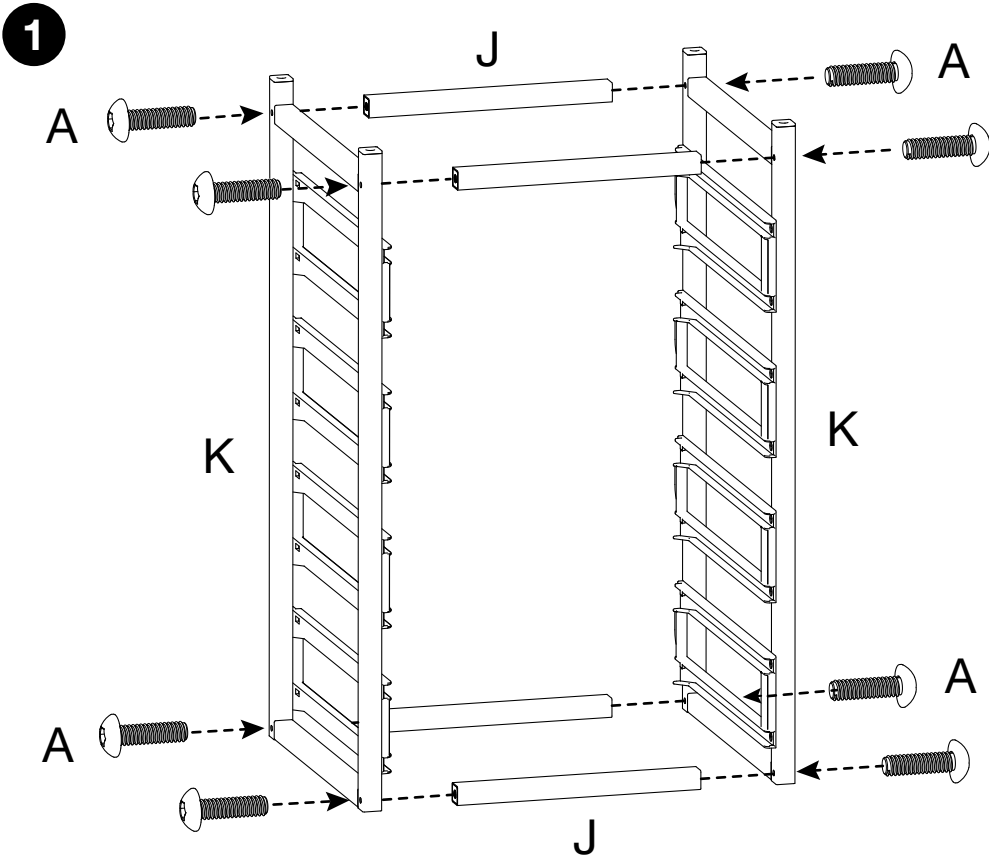

\* Do not fully tighten screws until the last step

# LUXOR

INNOVATIVE WORKSPACE PRODUCT SOLUTIONS

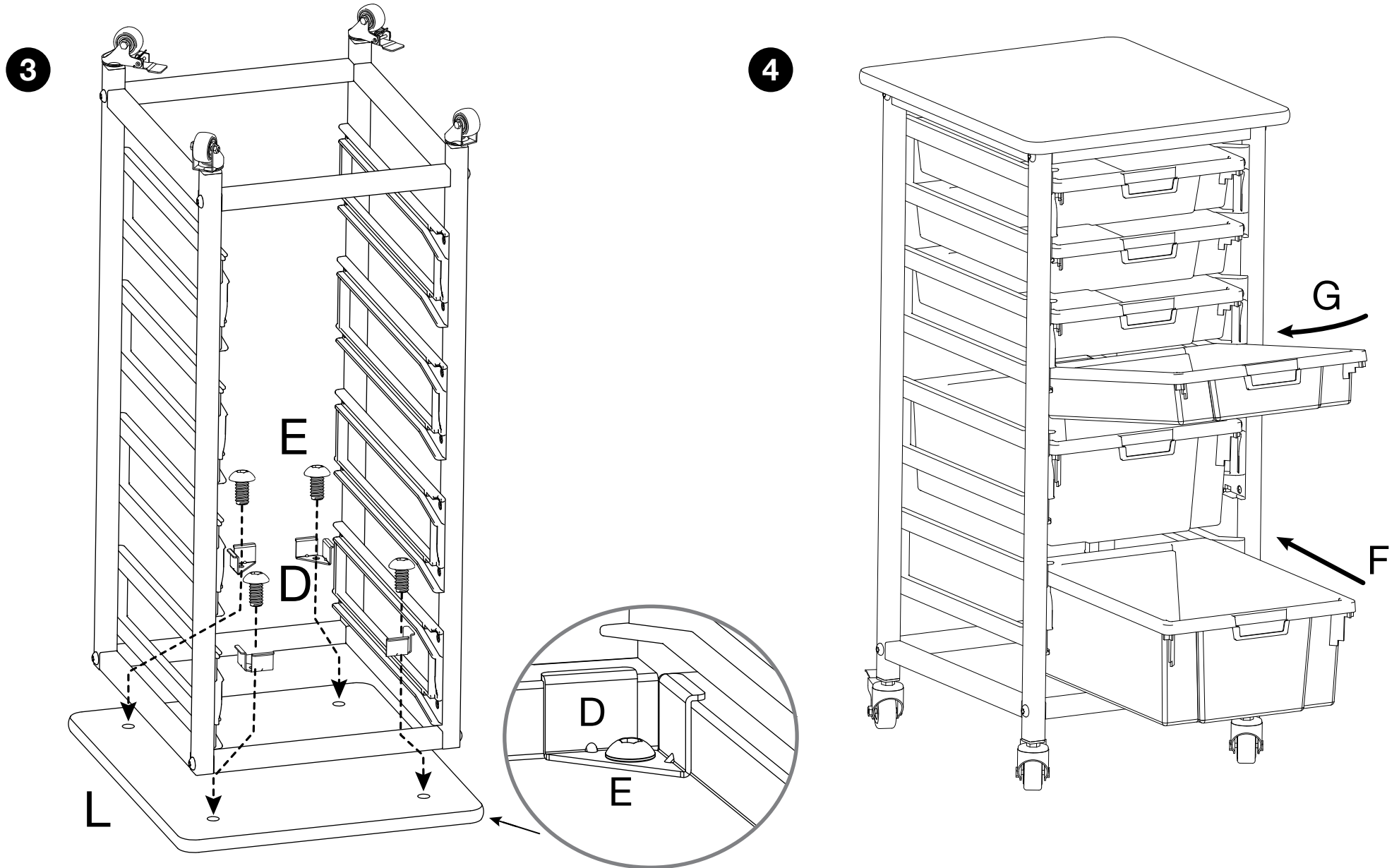

**\* Do not fully tighten screws until the last step**