

MooreCo's

SUMMER 2023

QuickShip

PROGRAM

Outfit your entire classroom with product shipping in just **2-10 DAYS**

FASTEST IN THE INDUSTRY



MOORECO



2885 Lorraine Avenue | Temple, TX 76501

p: 800.749.2258 | f: 866.888.7483

www.moorecoinc.com

©2023 MooreCo, Inc. All rights reserved.

MooreCo reserves the right to correct pricing and/or copy errors.
Due to the current volatility in the price of raw and finished materials,
please refer to our latest online price guides for pricing and shipping
information. www.moorecoinc.com/price-guides

MooreCo's

S U M M E R 2 0 2 3

QuickShip

P R O G R A M

what you get

Featuring products that are available as part of our QuickShip program to ship within ten business days or less! Contact your sales representative for volume purchases.



No Upcharge To Ship On Time

We don't charge you for faster shipping. We base our lead times on what we can get to you, not on what we can get out of you.

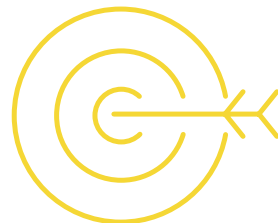

Guaranteed Lead Times

Products in our QuickShip program are available to ship to you within 2 to 10 days so you get your product when you need it. While supplies last.

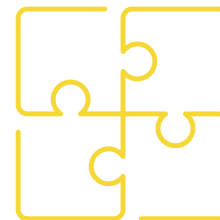

Outfit Your Entire Space

Our QuickShip program covers more than just desks and chairs. You can get wall mount boards, mobile boards, and more.



Design For Modern Learning

Our QuickShip products are designed for today's classroom with details that promote the latest educational philosophies.

At MooreCo we are proud to offer a QuickShip program that provides the most extensive product offering with the fastest lead times in the industry.



More colors and finishes than anyone else!

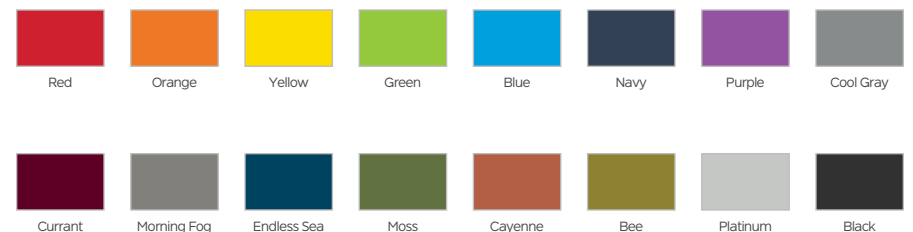

What's Inside:



2, 5, 7, and 10 Day Lead Time

Products with a two day lead time	12-18
Products with a five day lead time	19-25
Products with a seven day lead time	26-30
Products with a ten day lead time	31-32



Student Desks

Hierarchy Shapes Desk + Porcelain Steel Top	33
Essentials Economy Rectangle Desk	33
Economy Shapes Student Desk	33
Hierarchy Shapes Desk	33
Hierarchy Fender by MooreCo Desk	33
Up-Rite Student Desk	33
Hierarchy Boomerang Desk	33



Chairs & Stools

Hierarchy 4-Leg Chair	34
Hierarchy 4-Leg Caster Chair	34
Hierarchy Rocker Chair	34
Hierarchy 5-Star Stool	34
Hierarchy 5-Star Chair	34
Hierarchy Flipz Stool	34
Hierarchy Grow Stool®	34



Student Tables

Compass Makerspace Table	35
Height Adjustable Flipper Table	35



Common Area Tables

Height Adjustable Bistro Table	36
--------------------------------	----



Storage/Maker Space

Compass Makerspace Cabinets	37
-----------------------------	----



Technology

MoorePower® Tower	37
-------------------	----



Teacher Desks

Mobile Teacher Workstation II	38
Avid Modular Desk System	38



Visual Communication - Wall Mount Boards

Visionary® Magnetic Glass Board	39
Natural Cork Tackboard - Aluminum Trim	39
Porcelain Steel Whiteboard - Deluxe Aluminum Trim	39



Visual Communication - Mobile Boards

Hierarchy Grow & Roll Mobile Glass Board	39
Platinum Mobile Reversible Board	39
Essentials Mobile Whiteboard	39
Nest Easel	39

THRIVE™

BY MOORECO

What does a classroom need for students and teachers to thrive and how soon can you get your products?

Our Thrive philosophy embraces the importance of flexibility and collaboration in the environment. Our Quick Ship list has been carefully curated to offer a variety of products that truly accommodate the needs of students and teachers, no matter their style of learning or their age. Considering the 6 key aspects of human development, our Quick Ship program now allows consciously designed learning environments in just 10 days.



Physical + Psychological

Adjustability: We understand learning environments must constantly change to fit the needs of students. We offer several desks that adjust in height pneumatically or by assembly, allowing students to easily go from sit to stand.



Movement: We understand the importance of movement for students, and how movement is linked to learning. Our pulse, breathing, and circulation all change when we move, putting our brains into action.



It is important for teachers to be able to move around as well: as environments change, they change with them.





Intellectual + Social-Emotional

Collaboration: Working together is a primary tenet of active learning, and when students work together, the knowledge becomes a point of pride! This includes giving teachers a desk that can accommodate movement and collaboration.

Participation: When students share their ideas, they enhance their learning experience. Writing surfaces are an incredible resource for students to explain, ask, remember information and engage with others.



Moral + Spiritual

Balance: Students develop confidence, resilience, and wellbeing when they engage with the arts. Hands-on experiences such as maker space robotics, extra-curricular activities and career training programs support the development of balanced, confident, and inspired people.



MooreCo Classroom #1



**We ship your classroom
faster than anyone else.**



Hierarchy 4-Leg Chair
Lead Time: 5 Days



**Hierarchy Shapes Desk + Porcelain
Steel Top** Lead Time: 2 Days

MooreCo Classroom #2



Hierarchy Grow Stool®
Lead Time: 2 Days



Essentials Economy Rectangle Desk
Lead Time: 2 Days



Mobile Teacher Workstation II
Lead Time: 7 Days



Compass Cabinet - Maxi H2
Lead Time: 10 Days

MooreCo Classroom #3



Compass Cabinet - Maxi H2
Lead Time: 10 Days



**Hierarchy Grow & Roll
Mobile Glass Board**
Lead Time: 2 Days



Avid Modular Desk System
Lead Time: 7 Days



MoorePower® Tower
Lead Time: 2 Days



Hierarchy Shapes Desk
Lead Time: 5 Days



MooreCo Classroom #4

Example:
*Two households,
both alike in dignity,*

*Iambic Pentameter -
a line of verse with five metrical feet,
each consisting of one short (or unstressed)
syllable followed by one long (or stressed) syllable.*

Porcelain Steel Whiteboard -
Deluxe Aluminum Trim
Lead Time: 2 Days

Hierarchy 5-Star Stool
Lead Time: 5 Days

Mobile Teacher
Workstation II
Lead Time: 7 Days

Hierarchy Fender
by MooreCo Desk
Lead Time: 5 Days

Hierarchy Rocker Chair
Lead Time: 5 Days



Ships in

2 DAYS



Essentials Economy Rectangle Desk

- Top available in Fusion Maple or Gray Nebula with black edge band, and adjustable powder-coated black steel leg.
- Desks offer quick and easy assembly, numerous group configurations, and height adjustability from 21" to 30".
- Optional youth height leg insert lowers the adjustment by six inches to 15" to 24" high to accommodate early childhood users. Available as a stand-alone accessory—purchase both the standard rectangle and the shorter inserts, and assemble your table with the youth height leg insert. Sold in sets of four.

Laminate Top Options:



Fusion Maple (7909)



Gray Nebula (4622)

Edge Band Options:



Black

PART NO.	DESCRIPTION	DIMENSIONS	LEAD TIME
91672	Essentials Economy Rectangle Desk (Fusion Maple)	21" - 30"H x 26"W x 20"D	2 Days
91673	Essentials Economy Rectangle Desk (Gray Nebula)	21" - 30"H x 26"W x 20"D	2 Days



Economy Shapes Student Desk

- Desks offer quick and easy assembly, numerous group configurations, and height adjustability from 21" to 30". Optional youth height leg insert lowers the adjustment by six inches to 15" to 24" high to accommodate early childhood users.
- Top available in Fusion Maple or Gray Nebula with black edge band and adjustable powder-coated black steel leg. Legs feature swivel glides.

Laminate Top Options:



Fusion Maple (7909)



Gray Nebula (4622)

Edge Band Options:



Black

PART NO.	DESCRIPTION	DIMENSIONS	LEAD TIME
90580*	Economy Shapes Desk (Fusion Maple)	21" - 30"H x 28.8"W x 27.3"D	2 Days
90581	Economy Shapes Desk (Gray Nebula)	21" - 30"H x 28.8"W x 27.3"D	2 Days

 Ships in

2
DAYS



Standing height legs
adjust from 27" to 42"H!

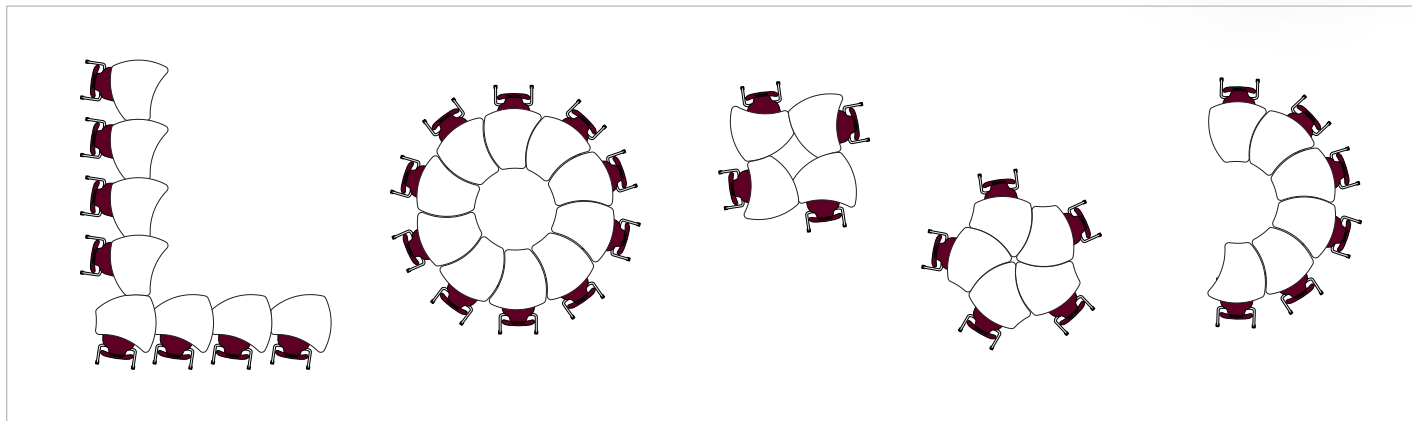

Hierarchy Shapes Desk + Porcelain Steel Top

- Now available with a porcelain steel whiteboard top, designed to provide space for doodling, jotting down notes and ideas, and brainstorming.
- Surface accepts magnets for even more versatility.
- Tests show porcelain is 2.5 times harder and twice as scratch-resistant as laminate, reducing dents, dings, and other damage. Surface is also 5.5 times more wear-resistant.
- Porcelain top is also resistant to delamination, keeping dry erasability intact for the life of the desk.

PART NO.	DESCRIPTION	DIMENSIONS	LEAD TIME
70522	Hierarchy Shapes Desk + Porcelain Steel Top (Black Legs)	22" - 32"H x 29.9"W x 28.4"D	2 Days
70523	Hierarchy Shapes Desk + Porcelain Steel Top (Platinum Legs)	22" - 32"H x 29.9"W x 28.4"D	2 Days
70523S	Hierarchy Shapes Desk + Porcelain Steel Top - Standing Height Legs (Platinum)	27" - 42"H x 29.9"W x 28.4"D	2 Days



Ships in

2 DAYS

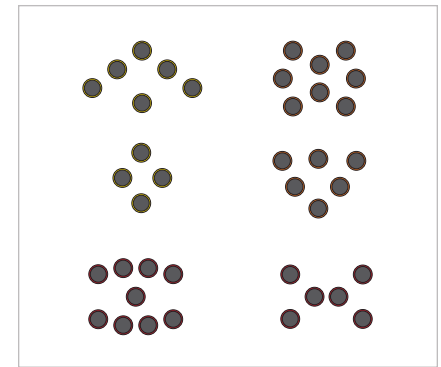

Hierarchy Grow Stool®

- Adjustable and colorful stool will add fun and function to any environments.
- Colors coordinate with our line of Hierarchy products.
- Shorter stool is height adjustable from 14" to 18", and taller stool adjusts from 17" to 24" to accommodate a variety of users.
- Wobble action and swiveling seat encourage micro-movement to help release excess energy.
- Helps promote upright posture and increased energy while working.
- Available in two sizes and ten colors!

Shell Color Options:

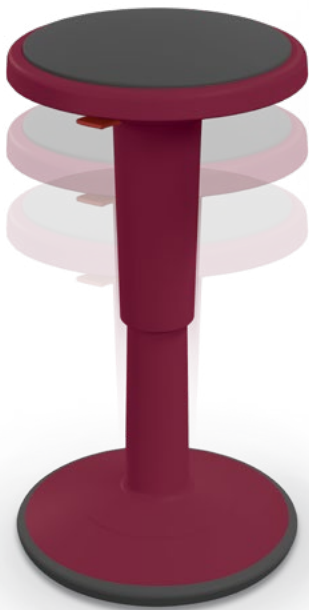
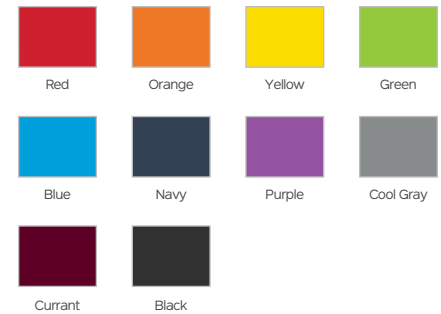

PART NO.	DESCRIPTION	DIMENSIONS	LEAD TIME
50960-XXXX	Short Stool (Specify Color)	14" - 18"H x 13"W x 13"D	2 Days
50970-XXXX	Tall Stool (Specify Color)	17" - 24"H x 13"W x 13"D	2 Days



Ships in

2

DAYS



Visionary® Magnetic Glass Board

- Tempered safety glass. Compatible with any dry/wet-erase marker, grease pen, etc.
- Attractive stainless steel mounting standoffs. Mounts are standard with a silver finish.
- Easily cleans without ghosting or staining. Accepts rare earth magnets.
- Fifty year limited warranty. SCS Indoor Advantage Gold Certified.

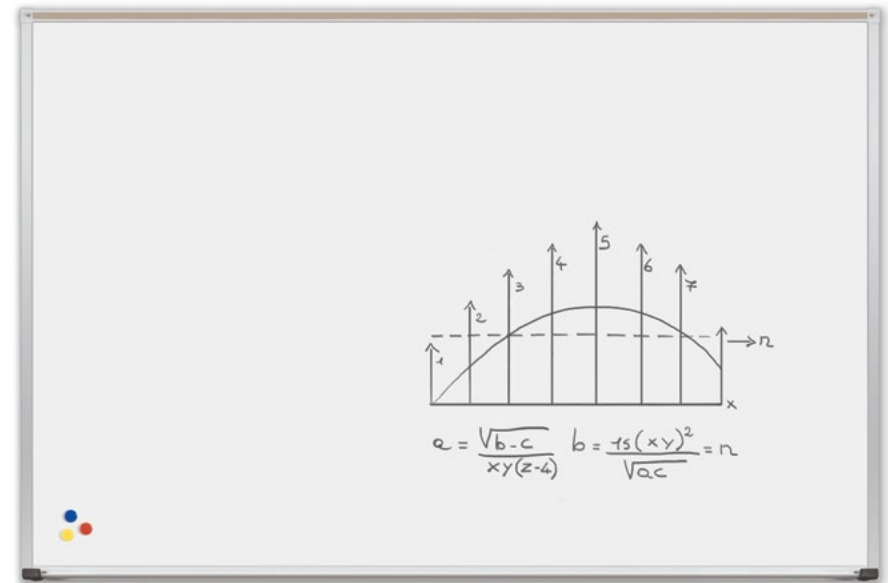

Porcelain Steel Whiteboard - Deluxe Aluminum Trim

- Magnetic porcelain steel whiteboards are engineered for superior color contrast with dry erase markers. Standard gloss dry erase surface provides superior writability and erasability with no ghosting.
- Reduced surface light distortion enhances visibility to provide optimum eye comfort.
- Steel is permanently laminated to a light weight substrate for stability and durability.
- Anodized aluminum trim has a 7/8" profile with hairline mitered corners. Includes a full-length tackable map rail with a colored cork insert, and a full-length accessory tray with rubber Dura-Safe® end caps to eliminate sharp edges.



PART NO.	DESCRIPTION	DIMENSIONS	LEAD TIME
83843	Gloss White	23.6"H x 35.4"W	2 Days
83841	Gloss White	47.2"H x 47.2"W	2 Days
83844	Gloss White	35.4"H x 47.2"W	2 Days
83845	Gloss White	47.2"H x 70.9"W	2 Days
83846	Gloss White	47.2"H x 94.5"W	2 Days

PART NO.	DESCRIPTION	DIMENSIONS	LEAD TIME
202AD-25	Porcelain Steel Whiteboard - Deluxe Aluminum Trim	4'H x 4'W	2 Days
202AG-25	Porcelain Steel Whiteboard - Deluxe Aluminum Trim	4'H x 6'W	2 Days
202AH-25	Porcelain Steel Whiteboard - Deluxe Aluminum Trim	4'H x 8'W	2 Days
202AK-25	Porcelain Steel Whiteboard - Deluxe Aluminum Trim	4'H x 10'W	2 Days
202AM-25	Porcelain Steel Whiteboard - Deluxe Aluminum Trim	4'H x 12'W	2 Days
202AP-25	Porcelain Steel Whiteboard - Deluxe Aluminum Trim	4'H x 16'W	2 Days



Ships in

2 DAYS

Natural Cork Tackboard - Aluminum Trim

- Classic unfinished cork adds an organic element to any environment.
- Our most economical and best value surface, Valu-Tak features 1/16" thick cork layer bonded to 7/16" lightweight and tackable substrate material.
- Anodized aluminum trim has a 7/8" profile with hairline mitered corners.

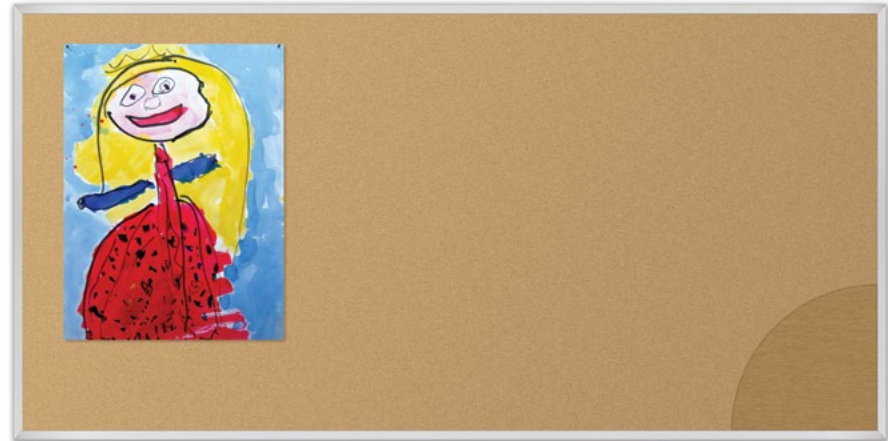

PART NO.	DESCRIPTION	DIMENSIONS	LEAD TIME
301AD	Valu-Tak - Aluminum Trim	4H x 4W	2 Days
301AF	Valu-Tak - Aluminum Trim	4H x 5W	2 Days
301AG	Valu-Tak - Aluminum Trim	4H x 6W	2 Days
301AH	Valu-Tak - Aluminum Trim	4H x 8W	2 Days

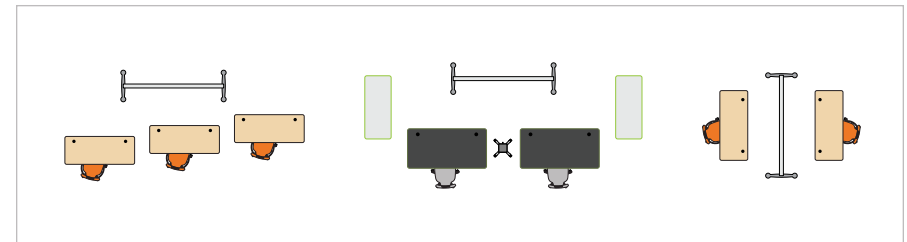

Platinum Mobile Reversible Board

- Mobile boards are double-sided.
- Panel is trimmed with modern anodized aluminum, rotates 360° on a pivot hinge, and locks into place with the turn of a knob.
- Trim includes a full-length accessory tray with perforated panel for style and stability.
- Wide base design for stability includes molded bumpers to protect walls, and 3" locking casters.

PART NO.	DESCRIPTION	DIMENSIONS	OVERALL DIMENSIONS	LEAD TIME
669RG-DD	Porcelain Steel / Porcelain Steel	4H x 6W	79.5H x 79.8W x 24"D	2 Days
669RG-HH	Dura-Rite / Dura-Rite	4H x 6W	79.5H x 79.8W x 24"D	2 Days

 Ships in

2
DAYS

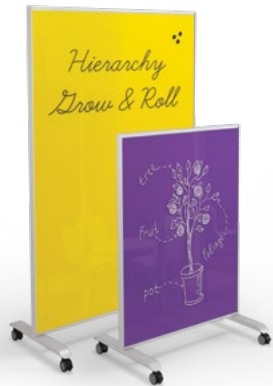

Hierarchy Grow & Roll Mobile Magnetic Glass Board

- Ideal for use in collaborative learning environments, the dual magnetic glass board allows for multiple users, while the floor to stand surface maximizes use.
- Available in two sizes. Standard with two locking and two non-locking casters.

Glass Color Options:

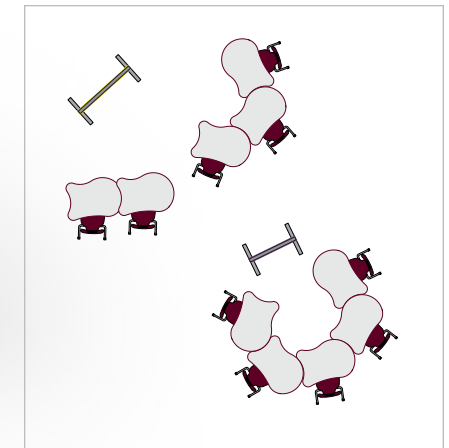
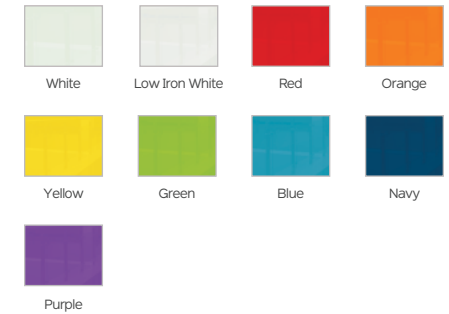

PART NO.	DESCRIPTION	DIMENSIONS	LEAD TIME
84425-WHITE	Hierarchy Grow & Roll Mobile Glass Board (4'H x 3'W) - Low Iron White	52.2"H x 35.7"W x 23.5"D	2 Days
84425-XXXX	Hierarchy Grow & Roll Mobile Glass Board (4'H x 3'W) - Specify Color	52.2"H x 35.7"W x 23.5"D	2 Days
84426-WHITE	Hierarchy Grow & Roll Mobile Glass Board (6'H x 4'W) - Low Iron White	73.2"H x 47.6"W x 23.5"D	2 Days
84426-XXXX	Hierarchy Grow & Roll Mobile Glass Board (6'H x 4'W) - Specify Color	73.2"H x 47.6"W x 23.5"D	2 Days



Ships in

2 DAYS

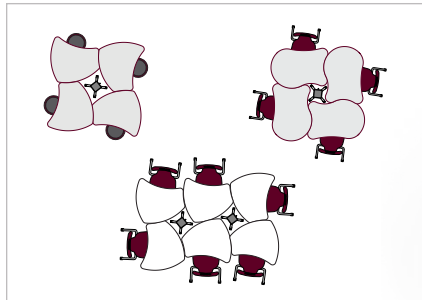

MoorePower® Tower

- Get convenient access to power in your multiuser table groups with the versatile and capable MoorePower® Tower.
- The Power Tower includes two AC outlets and two USB outlets on each of four sides, for a total of eight each.

PART NO.	DESCRIPTION	DIMENSIONS	LEAD TIME
27735*	MoorePower Tower	40"H x 17.5"W x 17.5"D	2 Days

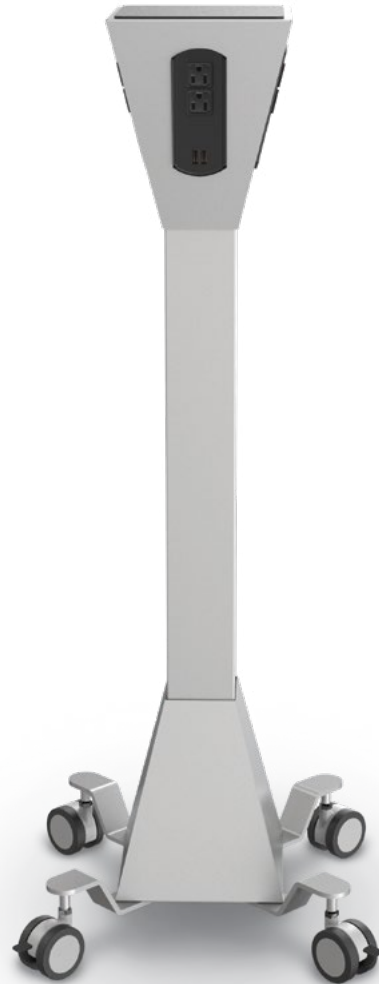

Nest Easel

- Versatile and mobile, the Nest Easel combines storage and magnetic dry erase space in one easy to use package.
- Can be adjusted to 65" or 72" high. Base includes 2" casters (two locking).



PART NO.	DESCRIPTION	DIMENSIONS	LEAD TIME
781P	Nest Easel - Black	72"H x 34.8"W x 24"D	2 Days
785P	Nest Easel - Silver	72"H x 34.8"W x 24"D	2 Days

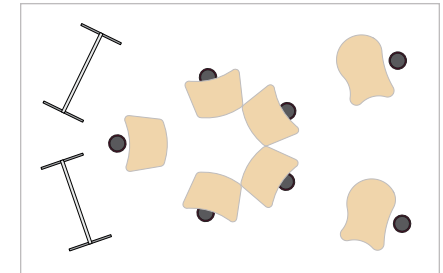
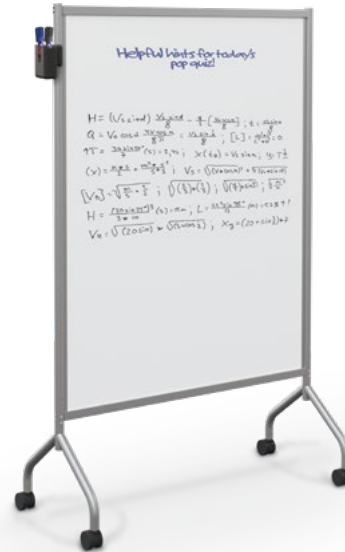

Essentials Mobile Whiteboard

- Get mobile dry erase space, create private work areas, and facilitate group learning with the Essentials Mobile Whiteboard.
- Double-sided dry erase whiteboard writing surfaces each measure 38.5"W x 54"H. Includes a handy marker cup that can be attached to the frame.

PART NO.	DESCRIPTION	DIMENSIONS	LEAD TIME
62542	Essentials Mobile Whiteboard - Platinum	71.8"H x 42"W x 21"D	2 Days

 Ships in

5
DAYS

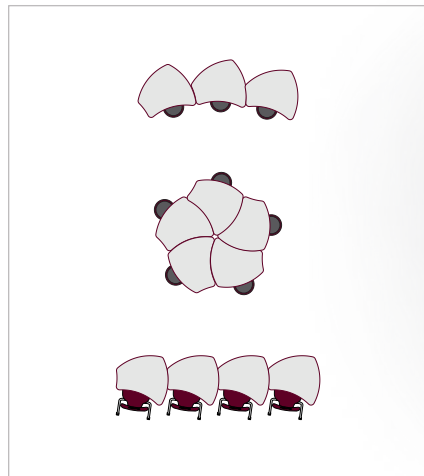

 **NEW CURRANT**
COLOR AVAILABLE! 

Hierarchy Shapes Desk

- Virtually endless configurations let you create custom layouts.
- The highly versatile table's ergonomic shape provides flexibility and workspace comfort. Allows easy left- or right-hand seating.
- Scratch resistant 1-1/4" thick HPL top with T-mold edge banding.
- Powder coated steel legs are height adjustable, and designed for quick assembly.

Laminate Top Options:

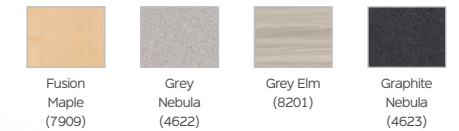

Edge Band Options:



PART NO.	DESCRIPTION	DIMENSIONS	LEAD TIME
11336X-XXXX-XX	Hierarchy Shapes Desk (Standard) - Black	22" - 32"H x 29.9"W x 28.4"D	5 Days
11436X-XXXX	Hierarchy Shapes Desk (Standard) - Platinum	22" - 32"H x 29.9"W x 28.4"D	5 Days
11836X-XXXX	Hierarchy Shapes Desk (Standard) - Standing Height Legs (Platinum)	27" - 42"H x 29.9"W x 28.4"D	5 Days



Ships in

5 DAYS

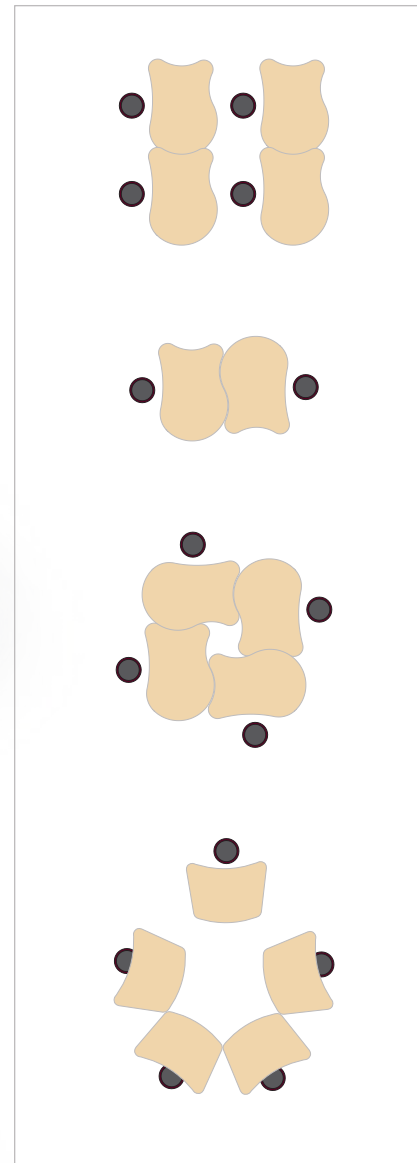

Up-Rite Student Desk

- Adjust for virtually any height, activity and position at the flip of a lever.
- Simple to make a collaborative configuration with two casters and two stabilizing glides, just tilt and reposition.
- With 26" to 43" of sit to stand adjustability, the Up-Rite Student Desk can work with either a chair or stool for position changes throughout the day.
- Standing desks are well known to contribute to more productivity, better posture, less energy dips and variety of other benefits.

Laminate Top Options:

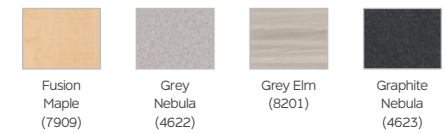

Edge Band Options:



PART NO.	DESCRIPTION	DIMENSIONS	LEAD TIME
90533-XXXX-XX	Up-Rite Student Desk (Platinum) - Curve Top	26" - 43"H x 26.6"W x 20"D	5 Days
90533-F-XXXX-XX	Up-Rite Student Desk (Platinum) - Fender Top	26" - 43"H x 33"W x 23"D	5 Days

 Ships in

5
DAYS

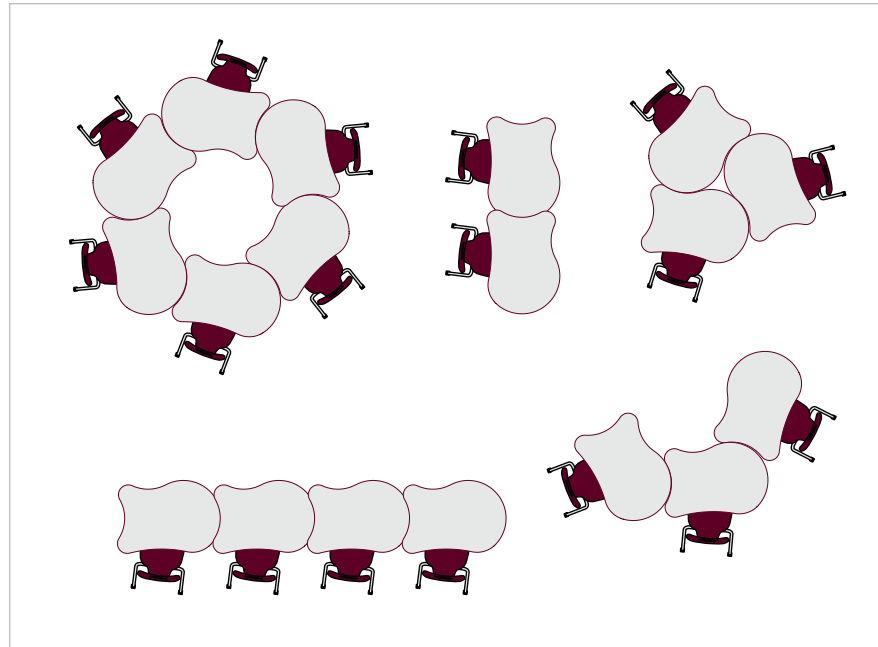

Hierarchy Fender By MooreCo Desk

- Innovative shape and curves create countless configurations.
- Available in two sizes (medium and large) and adjustable from 22" to 32"H in 1" increments.
- Youth height legs available for 12" to 18" height adjustment. Standing height legs available for 27" to 42" height adjustment.
- Join the desks together in a number of ways to fit your needs.
- Powder coated steel legs are height adjustable, and designed for quick assembly. Available in black or silver.

Laminate Top Options:

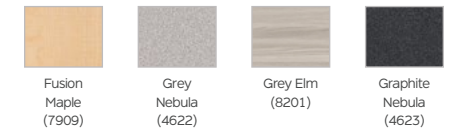

Edge Band Options:



PART NO.	DESCRIPTION	DIMENSIONS	LEAD TIME
11X3RX-XXXX*	Hierarchy Fender by MooreCo Desk (Standard) - Black	22" - 32"H x 33"W x 23"D	5 Days
1143RX-XXXX*	Hierarchy Fender by MooreCo Desk (Standard)- Platinum	22" - 32"H x 33"W x 23"D	5 Days
1183RX-XXXX*	Hierarchy Fender by MooreCo Desk (Standard) - Standing Height Legs (Platinum)	27" - 42"H x 33"W x 23"D	5 Days



Ships in

5 DAYS



Hierarchy Boomerang Desk

- The Hierarchy Boomerang Desk offers durability and custom options made to fit any classroom setting.
- Left- and right-hand accessible desks designed for individual, collaborative, or teacher-centered activities.
- Height adjustable legs (22" to 32" in 1" increments) allows even more flexibility.
- Standing height legs available for 27" to 42" height adjustment.

Laminate Top Options:

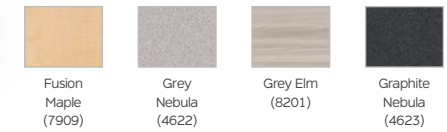

Edge Band Options:

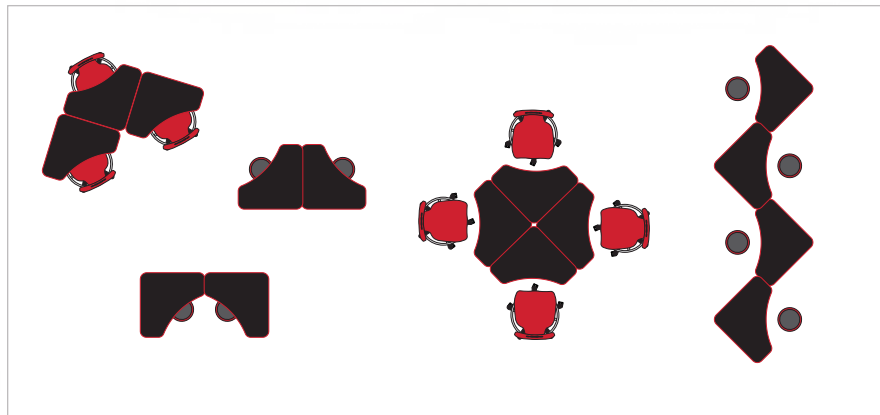

PART NO.	DESCRIPTION	DIMENSIONS	LEAD TIME
1033HX-XXXX	Hierarchy Boomerang Desk - Black	22" - 32"H x 36.7"W x 24"D	5 Days
1043HX-XXXX	Hierarchy Boomerang Desk - Platinum	22" - 32"H x 36.7"W x 24"D	5 Days
1083HX-XXXX	Hierarchy Boomerang Desk - Standing Height Legs (Platinum)	27" - 42"H x 36.7"W x 24"D	5 Days



Ships in

5 DAYS

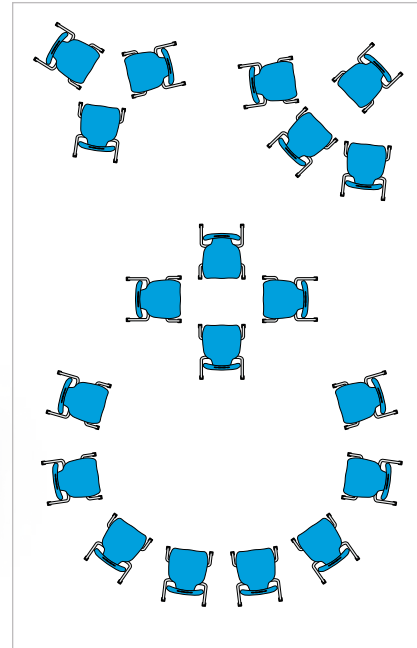

Hierarchy 4-Leg Caster Chair

Position a student for learning with the Hierarchy 4-Leg Caster Chair!

- Color, durability, and multiple size and base options for any classroom space.
- Smooth reinforced back allows for flex action without sharp ridges.
- A colorful and flexible solution for stimulating focus and motivation in any learning environment.

Hierarchy 4-Leg Chair

- With ergonomics in mind, the Hierarchy 4-Leg Chair is a colorful and flexible solution for stimulating focus and motivation in your learning environment.
- Multiple sizes, bases, and vibrant colors for all ages of learners.
- 4-leg available in four seat heights: 12", 14", 16", and 18" with platinum steel base.
- Includes nylon swivel glides.



Shell Color Options:

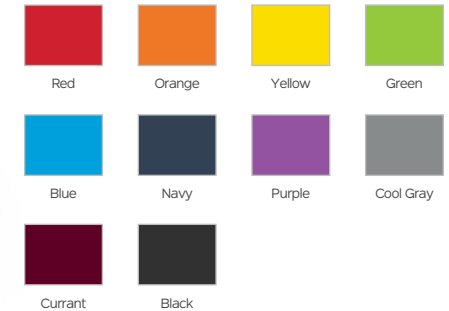

PART NO.	DESCRIPTION	DIMENSIONS	LEAD TIME
53312-1-XXXX-NA-PL	No Arms - 12" - Platinum Base	24"H x 16"W x 17"D	5 Days
53314-1-XXXX-NA-PL	No Arms - 14" - Platinum Base	25.5"H x 17"W x 17.5"D	5 Days
53316-1-XXXX-NA-PL	No Arms - 16" - Platinum Base	31.8"H x 18.5"W x 20.3"D	5 Days
53518-1-XXXX-NA-PL	No Arms - 18" - Platinum Base	33.5"H x 18.8"W x 22"D	5 Days

PART NO.	DESCRIPTION	DIMENSIONS	LEAD TIME
54318-1-XXXX-NA-CH-HC	No Arms - 18" - Chrome Base - Hard Casters	33.1"H x 20.5"W x 23.8"D	5 Days
54318-1-XXXX-NA-CH-SC	No Arms - 18" - Chrome Base - Soft Casters	33.1"H x 20.5"W x 23.8"D	5 Days



Ships in

5 DAYS

Hierarchy 5-Star Stool

- Multiple vibrant colors for all ages of learners. Flexible and ergonomically shaped seat for easy position changes, eliminating stagnant environments.
- Stool seat adjusts from 23" to 33"H; includes adjustable footrest
- 5-star base is made with durable steel and plastic and features 2" swivel casters, in your choice of hard or soft depending on your flooring needs.

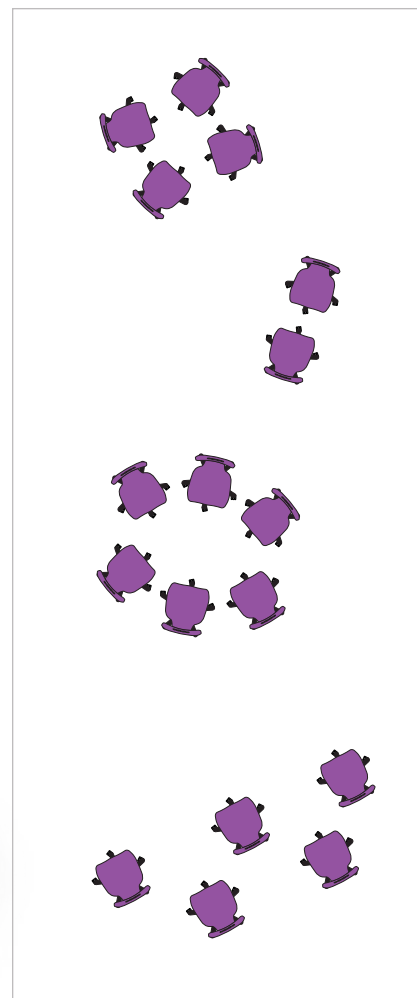

Hierarchy 5-Star Chair

- Adjustable base and vibrant colors for all ages of learners.
- Chair seat adjusts from 16-1/2" to 21-1/2"H.
- Base is made from durable black plastic and includes 2" swivel casters, in your choice of hard or soft depending on your flooring needs.

Shell Color Options:

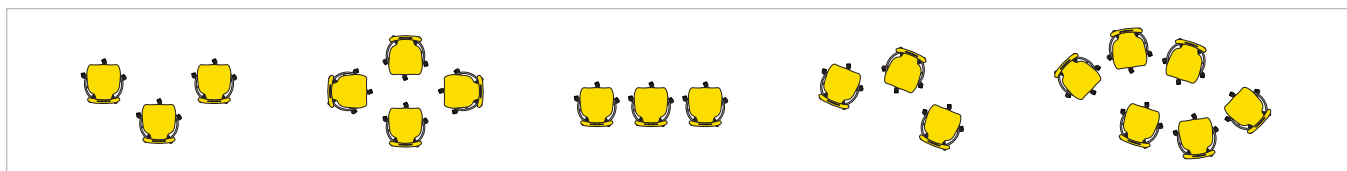
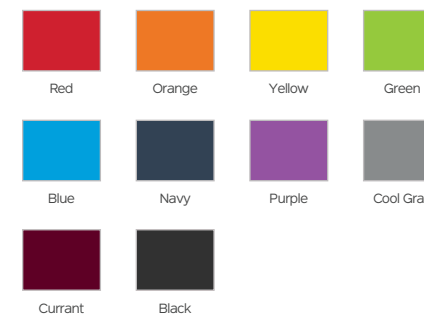

PART NO.	DESCRIPTION	DIMENSIONS	LEAD TIME
53512-XXXX-NA-HC	No Arms - Hard Casters	37.5" - 47.5"H x 24"W x 24"D	5 Days
53512-XXXX-NA-SC	No Arms - Soft Casters	37.5" - 47.5"H x 24"W x 24"D	5 Days

PART NO.	DESCRIPTION	DIMENSIONS	LEAD TIME
53511-XXXX-NA-HC	No Arms - Hard Casters	31" - 36"H x 24"W x 24"D	5 Days
53511-XXXX-NA-SC	No Arms - Soft Casters	31" - 36"H x 24"W x 24"D	5 Days



Ships in

5 DAYS



Hierarchy Rocker Chair

- Rocker base allows gentle and moderate movement to encourage calmness and cognitive processing.
- Heavy gauge platinum rocker base with floor-safe nylon glides.

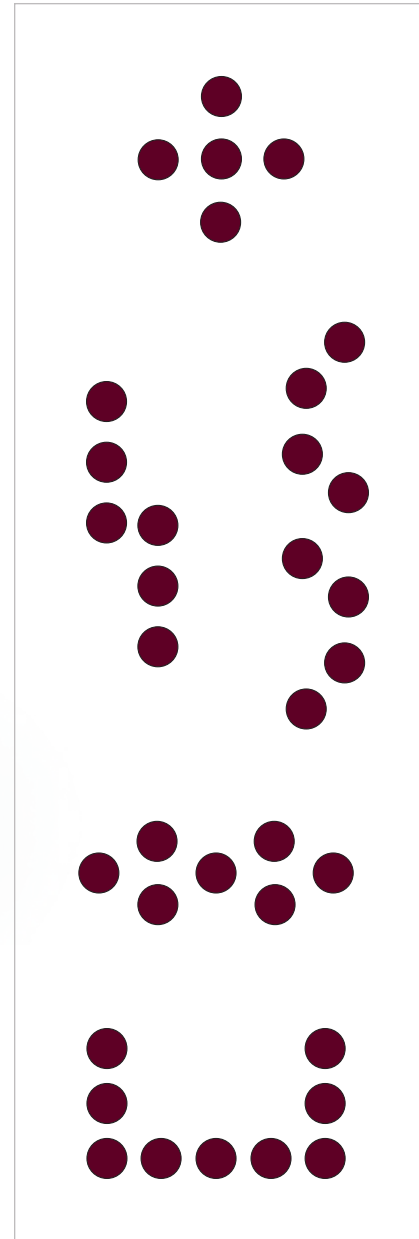
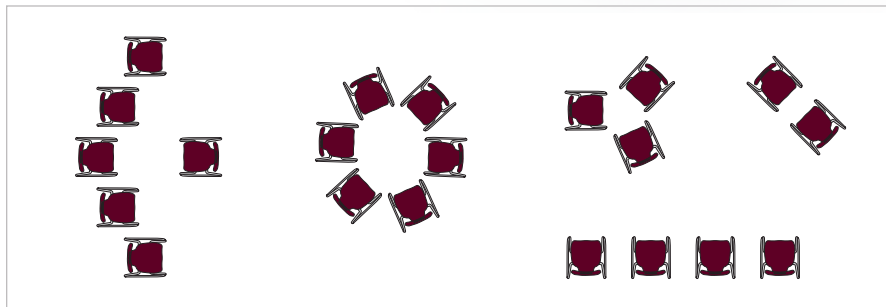

Hierarchy Flipz Stool

- Double ended stool can be used on one end as stationary seating and on the other as a rocking stool, offering gentle movement in all directions.
- Works like an exercise ball to keep a child's body moving, burning off extra energy and providing an outlet for restlessness.
- Each end is made with slip resistant rubber to keep the stool stable on any flooring material.
- Stools stack for easy storage when not in use.

Shell Color Options:



PART NO.	DESCRIPTION	DIMENSIONS	LEAD TIME
54716-1-XXXX-NA-PL	No Arms - 16" Platinum	30.5"H x 22.8"W x 23.6"D	5 Days

PART NO.	DESCRIPTION	DIMENSIONS	LEAD TIME
83464-XXXX*	Hierarchy Flipz Stool	17.1"H x 12"W x 12"D	5 Days



Ships in

7

DAYS



91775



91778

Avid Modular Desk System

- The flexible and customizable design of the Avid Modular Desk System makes creating your ideal workspace a breeze. Platinum base adds style to any space.
- Available with four basic top sizes.
- Pedestals offer ample file and supply storage and include screw-on handles.

Laminate Top Options:

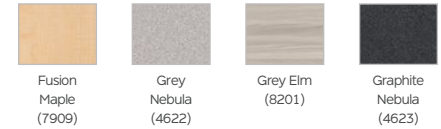

Edge Band Options:

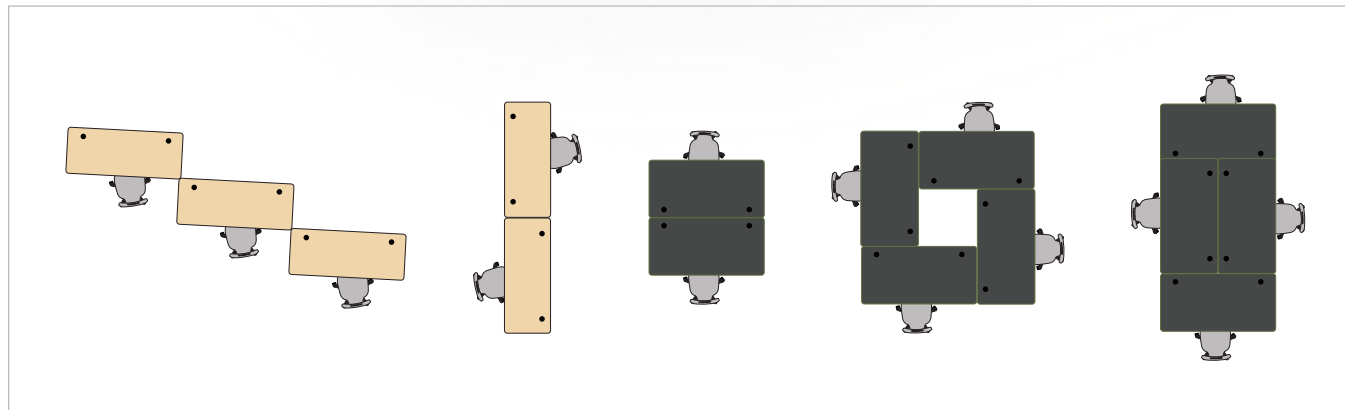

PART NO.	DESCRIPTION	DIMENSIONS	LEAD TIME
91774-XXXX-XX	Avid Single Pedestal Desk - 6030	29.8"H x 60"W x 30"D	7 Days
91775-XXXX-XX	Avid Single Pedestal Desk - 6024	29.8"H x 60"W x 24"D	7 Days
91776-XXXX-XX	Avid Single Pedestal Desk - 7230	29.8"H x 72"W x 30"D	7 Days
91778-XXXX-XX	Avid Double Pedestal Desk - 6030	29.8"H x 60"W x 30"D	7 Days
91779-XXXX-XX	Avid Double Pedestal Desk - 6024	29.8"H x 60"W x 24"D	7 Days
91780-XXXX-XX	Avid Double Pedestal Desk - 7230	29.8"H x 72"W x 30"D	7 Days



Ships in

7

DAYS

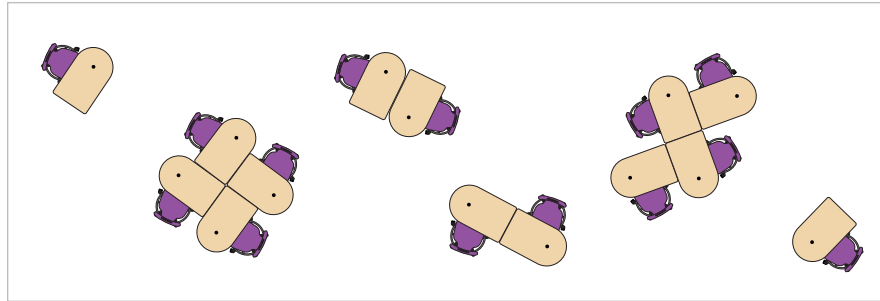

Mobile Teacher Workstation II

- Ideal for the teacher on-the-go, the Mobile Teacher Workstation II is a stylish and mobile solution to today's changing classroom needs.
- Grommet provides easy cable management.
- Optional modesty panel and optional accessory locking pencil drawer available.

Laminate Top Options:

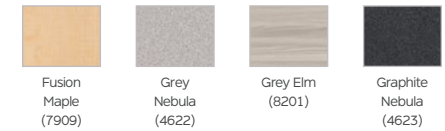

Edge Band Options:



PART NO.	DESCRIPTION	DIMENSIONS	LEAD TIME
91289-XXXX-XX	Mobile Teacher Workstation II	40"H X 47.6"W X 30"D	7 Days
OPTIONAL ACCESSORIES			
34443*	Accessory Locking Pencil Drawer	3.5"H x 15.5"W x 12.5"D	7 Days



Ships in

7

DAYS

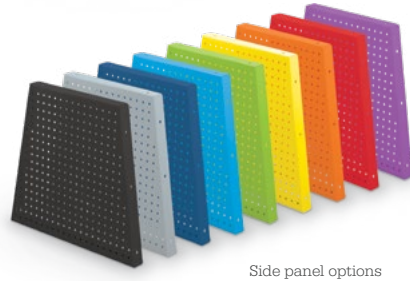

Side panel options

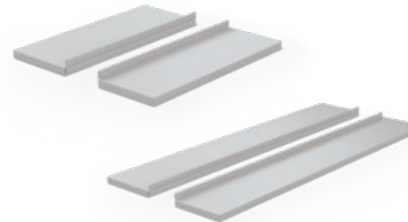
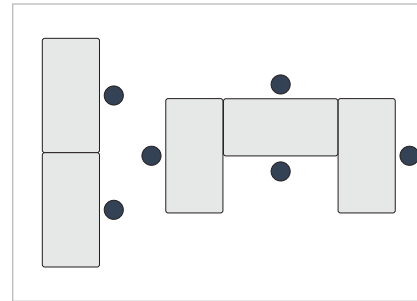

Optional shelves require side panels.

Compass Makerspace Tables

- Compass Makerspace Tables are designed to foster active thinking, creating, and doing!
- Available in 29" or 42" heights for use while sitting or standing, we offer a wide variety of table top sizes to accommodate users, materials, and to provide a spacious work area that will foster a spacious mind.

Laminate Top Options:



Edge Band Options:



PART NO.	DESCRIPTION	DIMENSIONS	LEAD TIME
91694-A-XXXX-XX	Compass Makerspace Table 6030 - Laminate Top (29")	29"H x 60"W x 30"D	7 Days
91694-B-XXXX-XX	Compass Makerspace Table 7230 - Laminate Top (29")	29"H x 72"W x 30"D	7 Days
91696-A-XXXX-XX	Compass Makerspace Table 6030 - Laminate Top (42")	42"H x 60"W x 30"D	7 Days
91696-B-XXXX-XX	Compass Makerspace Table 7230 - Laminate Top (42")	42"H x 72"W x 30"D	7 Days
52990-XXXX	Side Panels	19"H x 21.7"W x 1.5"D	7 Days
OPTIONAL ACCESSORIES			
91699	Shelves for 60" or 72" Table (2)	1.9"H x 58.2"W x 9"D	7 Days



Ships in

7

DAYS

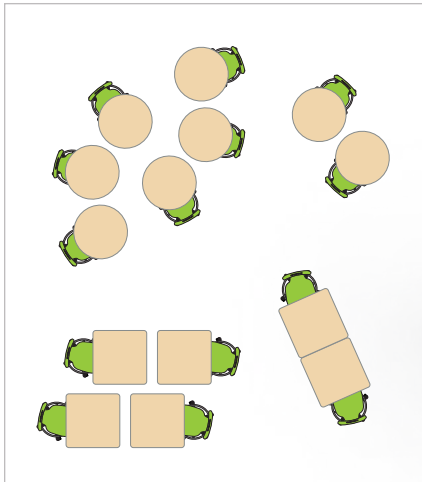

**Height Adjustable
Bistro Table**

- Height Adjustable Bistro Tables blend modern design with timeless durability for tables that will bring a lifetime of use.
- Features a 1-1/8" thick top finished with scratch-resistant laminate with a brushed steel base.
- Available in square or round shape.

Laminate Top Options:

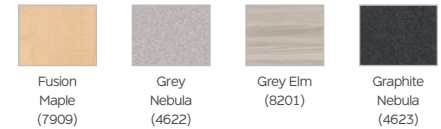

Edge Band Options:



PART NO.	DESCRIPTION	DIMENSIONS	LEAD TIME
91189-S-XXXX-XX	Height Adjustable Bistro Table (Square)	30" - 38"H x 28"W x 28"D	7 Days
91189-R-XXXX-XX	Height Adjustable Bistro Table (Round)	30" - 38"H x 28"W x 28"D	7 Days



Ships in

7

DAYS

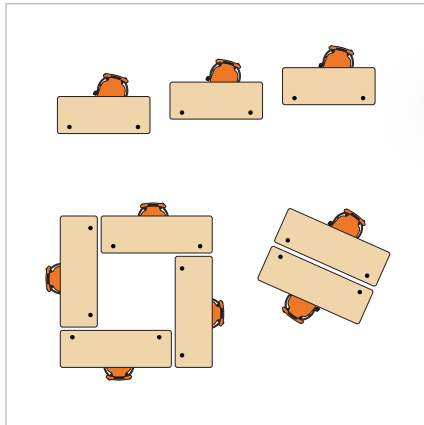

Height Adjustable Sit/Stand Flipper Tables (28.5" - 45")

- Easily accommodate a range of ages and sizes with the Height Adjustable Flipper Conference & Training Table.
- Tables adjust from 28.5" to 45" high, designed to allow easy viewing with stadium style seating in larger training room environments.

Laminate Top Options:

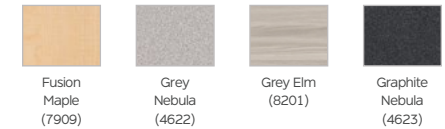

Edge Band Options:



PART NO.	DESCRIPTION	DIMENSIONS	LEAD TIME
90316-XXXX-XX	Height Adjustable Sit/Stand Flipper Table - 6024 Rectangle	28.5" - 45"H x 60"W x 24"D	7 Days
90317-XXXX-XX	Height Adjustable Sit/Stand Flipper Table - 7224 Rectangle	28.5" - 45"H x 72"W x 24"D	7 Days
OPTIONAL ACCESSORIES			
66626	HAFT Modesty Panel for 60" Table	9.5"H x 46.5"W x 3.3"D	7 Days
66627	HAFT Modesty Panel for 72" Table	9.5"H x 58.3"W x 3.3"D	7 Days



Ships in

10 DAYS



Compass Makerspace Cabinets

- Empowering students to think, create, and do! Our extensive line of modular cabinets leads to fun and discovery.
- Offering virtually endless configuration options, Compass cabinets are designed to bring your maker space, classroom, or collaboratorium maximum activity flexibility, with a wide range of storage options, tops, and accessories.

Panel Color Options:

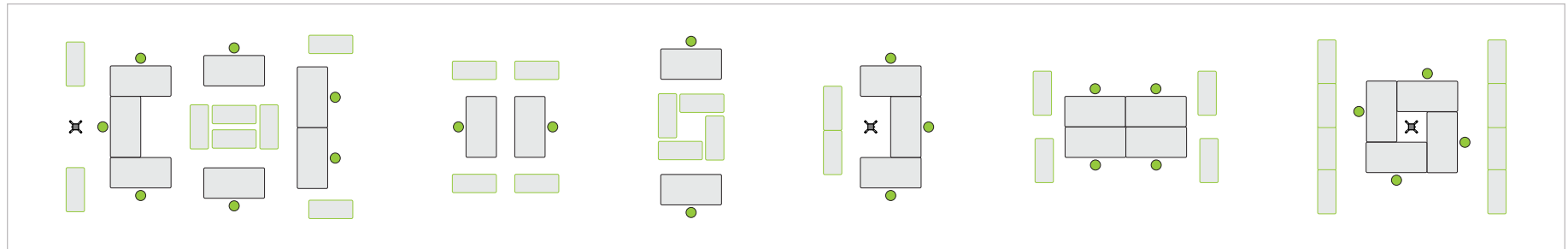
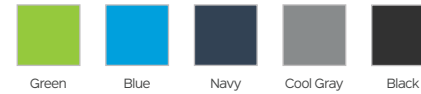

PART NO.	DESCRIPTION	DIMENSIONS	LEAD TIME
B3A1X2A1X0	Maxi H2 - Doors + (24) 3" Totes	36.1"H x 42"W x 19.2"D	10 Days
B3A1X2A1X2	Maxi H2 - Doors + (8) 3" Totes + Left Hand Shelves	36.1"H x 42"W x 19.2"D	10 Days
B3A1X2D1X0	Maxi H2 - Doors + Shelves	36.1"H x 42"W x 19.2"D	10 Days
B3A1X1C1X0	Maxi H2 - (12) 3" Totes + (6) 6" Totes	36.1"H x 42"W x 19.2"D	10 Days
B3A1X1B1X0	Maxi H2 - (12) 6" Totes	36.1"H x 42"W x 19.2"D	10 Days
B3A1X1A1X0	Maxi H2 - (24) 3" Totes	36.1"H x 42"W x 19.2"D	10 Days
B3A1X1A1X2	Maxi H2 - (8) 3" Totes + Left Hand Shelves	36.1"H x 42"W x 19.2"D	10 Days
B3A1X1D1X0	Maxi H2 - Shelves	36.1"H x 42"W x 19.2"D	10 Days
C3A1X2A1X2	Maxi H3 - Doors + (12) 3" Totes + Left Hand Shelves	51.1"H x 42"W x 19.2"D	10 Days
C3A1X2B1X0	Maxi H3 - Doors + (18) 6" Totes	51.1"H x 42"W x 19.2"D	10 Days
C3A1X2A1X0	Maxi H3 - Doors + (36) 3" Totes	51.1"H x 42"W x 19.2"D	10 Days
C3A1X2F1X0	Maxi H3 - Doors + (9) 3" Totes + (9) 6" Totes + (3) 12" Totes	51.1"H x 42"W x 19.2"D	10 Days
C3A1X2D1X0	Maxi H3 - Doors + Shelves	51.1"H x 42"W x 19.2"D	10 Days
C3A1X1A1X2	Maxi H3 - (12) 3" Totes + Left Hand Shelves	51.1"H x 42"W x 19.2"D	10 Days
C3A1X1B1X0	Maxi H3 - (18) 6" Totes	51.1"H x 42"W x 19.2"D	10 Days
C3A1X1A1X0	Maxi H3 - (36) 3" Totes	51.1"H x 42"W x 19.2"D	10 Days
C3A1X1F1X0	Maxi H3 - (9) 3" Totes + (9) 6" Totes + (3) 12" Totes	51.1"H x 42"W x 19.2"D	10 Days
C3A1X1D1X0	Maxi H3 - Shelves	51.1"H x 42"W x 19.2"D	10 Days
D3A1X2E1X0	Grande - Doors + Cubbies	60.6"H x 42"W x 19.2"D	10 Days
D3A1X2D1X0	Grande - Doors + Shelves	60.6"H x 42"W x 19.2"D	10 Days
D3A1X1E1X0	Grande - Cubbies	60.6"H x 42"W x 19.2"D	10 Days
D3A1X1D1X0	Grande - Shelves	60.6"H x 42"W x 19.2"D	10 Days



Student Desks



Hierarchy Shapes Desk + Porcelain Steel Top



Ships in 2 days
Page 13



Essentials Economy Rectangle Desk



Ships in 2 days
Page 12



Economy Shapes Student Desk



Ships in 2 days
Page 12



Hierarchy Shapes Desk



Ships in 5 days
Page 19



Hierarchy Fender by MooreCo Desk



Ships in 5 days
Page 21



Up-Rite Student Desk - Fender Top



Ships in 5 days
Page 20



Up-Rite Student Desk - Curve Top



Ships in 5 days
Page 20



Hierarchy Boomerang Desk



Ships in 5 days
Page 22



Student Chairs & Stools



Hierarchy 4-Leg Chair



Ships in 5 days
Page 23



Hierarchy 4-Leg Caster Chair



Ships in 5 days
Page 23



Hierarchy Rocker Chair



Ships in 5 days
Page 25



Hierarchy 5-Star Stool



Ships in 5 days
Page 24



Hierarchy 5-Star Chair



Ships in 5 days
Page 24



Hierarchy Flipz Stool



Ships in 5 days
Page 25

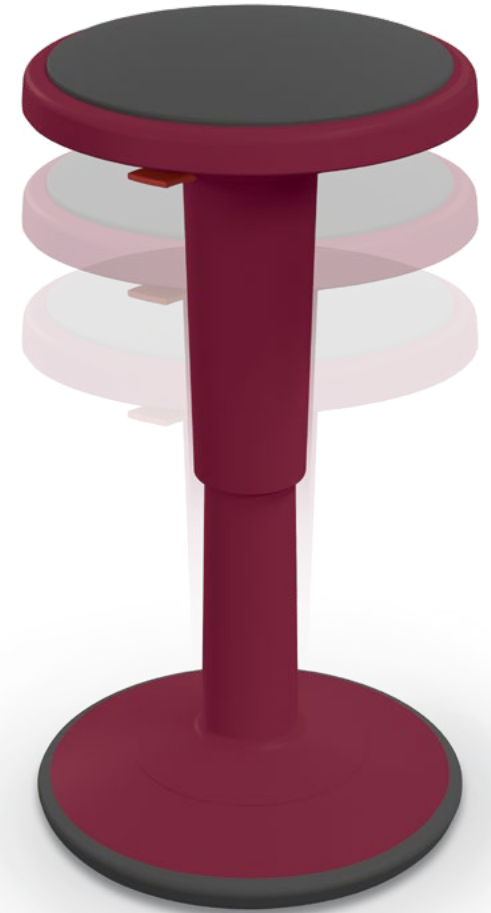

Hierarchy Grow Stool®



Ships in 5 days
Page 14

Student Tables



Compass Makerspace Table

 **Ships in 7 days**
Page 29



Height Adjustable Flipper Table

 **Ships in 7 days**
Page 31



Common Area Tables



Height Adjustable Bistro Table -Square



Ships in 7 days
Page 30



Height Adjustable Bistro Table -Round



Ships in 7 days
Page 30

Storage/Maker Space



Compass Makerspace Cabinet - Maxi H3

 **Ships in 10 days**
Page 32

Technology



Compass Makerspace
Cabinet - Grande

 **Ships in 10 days**
Page 32



Compass Makerspace
Cabinet - Maxi H2

 **Ships in 10 days**
Page 32



MoorePower® Tower

 **Ships in 2 days**
Page 18



Teacher Desks



Mobile Teacher Workstation II



Ships in 7 days
Page 29



Avid Modular Desk System



Ships in 7 days
Page 26

Visual Communication - Wall Mount Boards



Visionary® Magnetic Glass Board

 **Ships in 2 days**
Page 15



Natural Cork Tackboard
- Aluminum Trim

 **Ships in 2 days**
Page 16

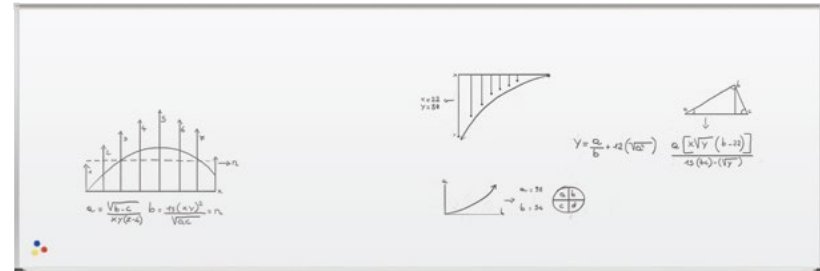

Porcelain Steel Whiteboard - Deluxe Aluminum Trim

 **Ships in 2 days**
Page 15

Visual Communication - Mobile Boards

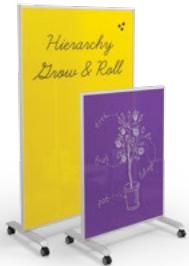

Hierarchy Grow & Roll Mobile
Magnetic Glass Board

 **Ships in 2 days**
Page 17



Platinum Mobile Reversible Board

 **Ships in 2 days**
Page 16



Essentials Mobile Whiteboard

 **Ships in 2 days**
Page 18



Nest Easel

 **Ships in 2 days**
Page 18

QuickShip Price Guide

PART NO.	DESCRIPTION	DIMENSIONS	LEAD TIME	MSRP	PAGE
91672	Essentials Economy Rectangle Desk (Fusion Maple)	21" - 30"H x 26"W x 20"D	2 Days	\$291.29	9, 12, 34
91673	Essentials Economy Rectangle Desk (Gray Nebula)	21" - 30"H x 26"W x 20"D	2 Days	\$291.29	9, 12, 34
90580*	Economy Shapes Desk (Fusion Maple)	21" - 30"H x 28.8"W x 27.3"D	2 Days	\$298.38	12, 34
90581	Economy Shapes Desk (Gray Nebula)	21" - 30"H x 28.8"W x 27.3"D	2 Days	\$298.38	12, 34
70522	Hierarchy Shapes Desk + Porcelain Steel Top (Black Legs)	22" - 32"H x 29.9"W x 28.4"D	2 Days	\$490.66	8, 13, 34
70523	Hierarchy Shapes Desk + Porcelain Steel Top (Platinum Legs)	22" - 32"H x 29.9"W x 28.4"D	2 Days	\$490.66	8, 13, 34
70523S	Hierarchy Shapes Desk + Porcelain Steel Top - Standing Height Legs (Platinum)	27" - 42"H x 29.9"W x 28.4"D	2 Days	\$631.46	13, 34
11336X-XXXX-XX	Hierarchy Shapes Desk (Standard) - Black	22" - 32"H x 29.9"W x 28.4"D	5 Days	\$490.66	10, 19, 34
11436X-XXXX	Hierarchy Shapes Desk (Standard) - Platinum	22" - 32"H x 29.9"W x 28.4"D	5 Days	\$490.66	10, 19, 34
11836X-XXXX	Hierarchy Shapes Desk (Standard) - Standing Height Legs (Platinum)	27" - 42"H x 29.9"W x 28.4"D	5 Days	\$631.46	19, 34
90533-XXXX-XX	Up-Rite Student Desk (Platinum) - Curve Top	26" - 43"H x 26.6"W x 20"D	5 Days	\$701.79	20, 34
90533-F-XXXX-XX	Up-Rite Student Desk (Platinum) - Fender Top	26" - 43"H x 33"W x 23"D	5 Days	\$701.79	20, 34
11X3RX-XXXX*	Hierarchy Fender by MooreCo Desk (Standard) - Black	22" - 32"H x 33"W x 23"D	5 Days	\$490.66	21, 34
1143RX-XXXX*	Hierarchy Fender by MooreCo Desk (Standard)- Platinum	22" - 32"H x 33"W x 23"D	5 Days	\$490.66	11, 21, 34
1183RX-XXXX*	Hierarchy Fender by MooreCo Desk (Standard) - Standing Height Legs (Platinum)	27" - 42"H x 33"W x 23"D	5 Days	\$631.46	21, 34
1033HX-XXXX	Hierarchy Boomerang Desk - Black	22" - 32"H x 36.7"W x 24"D	5 Days	\$579.72	22, 34
1043HX-XXXX	Hierarchy Boomerang Desk - Platinum	22" - 32"H x 36.7"W x 24"D	5 Days	\$579.72	22, 34
1083HX-XXXX	Hierarchy Boomerang Desk - Standing Height Legs (Platinum)	27" - 42"H x 36.7"W x 24"D	5 Days	\$720.52	22, 34
91774-XXXX-XX	Avid Single Pedestal Desk - 6030	29.8"H x 60"W x 30"D	7 Days	\$2,113.13	10, 26, 39
91775-XXXX-XX	Avid Single Pedestal Desk - 6024	29.8"H x 60"W x 24"D	7 Days	\$2,070.15	26, 39
91776-XXXX-XX	Avid Single Pedestal Desk - 7230	29.8"H x 72"W x 30"D	7 Days	\$2,266.06	26, 39
91778-XXXX-XX	Avid Double Pedestal Desk - 6030	29.8"H x 60"W x 30"D	7 Days	\$2,904.95	26, 39
91779-XXXX-XX	Avid Double Pedestal Desk - 6024	29.8"H x 60"W x 24"D	7 Days	\$2,861.99	26, 39
91780-XXXX-XX	Avid Double Pedestal Desk - 7230	29.8"H x 72"W x 30"D	7 Days	\$3,008.86	26, 39
91289-XXXX-XX	Mobile Teacher Workstation II	40"H X 47.6"W X 30"D	7 Days	\$1,857.00	9, 28, 39
OPTIONAL ACCESSORIES					
34443*	Accessory Locking Pencil Drawer	3.5"H x 15.5"W x 12.5"D	7 Days		
91694-A-XXXX-XX	Compass Makerspace Table 6030 - Laminate Top (29")	29"H x 60"W x 30"D	7 Days	\$1,172.45	29, 36
91694-B-XXXX-XX	Compass Makerspace Table 7230 - Laminate Top (29")	29"H x 72"W x 30"D	7 Days	\$1,133.75	29, 36
91696-A-XXXX-XX	Compass Makerspace Table 6030 - Laminate Top (42")	42"H x 60"W x 30"D	7 Days	\$1,258.08	29, 36
91696-B-XXXX-XX	Compass Makerspace Table 7230 - Laminate Top (42")	42"H x 72"W x 30"D	7 Days	\$1,300.18	29, 36
52990-XXXX	Side Panels	19"H x 21.7"W x 1.5"D	7 Days	\$211.74	29
OPTIONAL ACCESSORIES					
91699	Shelves for 60" or 72" Table (2)	1.9"H x 58.2"W x 9"D	7 Days	\$309.37	29
91189-S-XXXX-XX	Height Adjustable Bistro Table (Square)	30" - 38"H x 28"W x 28"D	7 Days	\$970.17	30, 37
91189-R-XXXX-XX	Height Adjustable Bistro Table (Round)	30" - 38"H x 28"W x 28"D	7 Days	\$970.17	30, 37
90316-XXXX-XX	Height Adjustable Sit/Stand Flipper Table - 6024 Rectangle	28.5" - 45"H x 60"W x 24"D	7 Days	\$754.94	31, 36
90317-XXXX-XX	Height Adjustable Sit/Stand Flipper Table - 7224 Rectangle	28.5" - 45"H x 72"W x 24"D	7 Days	\$847.75	31, 36

PART NO.	DESCRIPTION	DIMENSIONS	LEAD TIME	MSRP	PAGE
OPTIONAL ACCESSORIES					
66626	HAFT Modesty Panel for 60" Table	9.5"H x 46.5"W x 3.3"D	7 Days	\$195.40	31
66627	HAFT Modesty Panel for 72" Table	9.5"H x 58.3"W x 3.3"D	7 Days	\$249.62	31
53312-1-XXXX-NA-PL	No Arms - 12" - Platinum Base	24"H x 16"W x 17"D	5 Days	\$158.13	8, 9, 10, 23, 35
53314-1-XXXX-NA-PL	No Arms - 14" - Platinum Base	25.5"H x 17"W x 17.5"D	5 Days	\$168.76	8, 9, 10, 23, 35
53316-1-XXXX-NA-PL	No Arms - 16" - Platinum Base	31.8"H x 18.5"W x 20.3"D	5 Days	\$179.17	8, 9, 10, 23, 35
53518-1-XXXX-NA-PL	No Arms - 18" - Platinum Base	33.5"H x 18.8"W x 22"D	5 Days	\$183.59	8, 9, 10, 23, 35
54318-1-XXXX-NA-CH-HC	No Arms - 18" - Chrome Base - Hard Casters	33.1"H x 20.5"W x 23.8"D	5 Days	\$237.88	23, 35
54318-1-XXXX-NA-CH-SC	No Arms - 18" - Chrome Base - Soft Casters	33.1"H x 20.5"W x 23.8"D	5 Days	\$249.95	23, 35
53511-XXXX-NA-HC	No Arms - Hard Casters	31" - 36"H x 24"W x 24"D	5 Days	\$370.02	24, 35
53511-XXXX-NA-SC	No Arms - Soft Casters	31" - 36"H x 24"W x 24"D	5 Days	\$379.16	24, 35
53512-XXXX-NA-HC	No Arms - Hard Casters	37.5" - 47.5"H x 24"W x 24"D	5 Days	\$488.25	9, 11, 24, 35
53512-XXXX-NA-SC	No Arms - Soft Casters	37.5" - 47.5"H x 24"W x 24"D	5 Days	\$497.40	9, 11, 24, 35
54716-1-XXXX-NA-PL	No Arms - 16" Platinum	30.5"H x 22.8"W x 23.6"D	5 Days	\$280.74	11, 25, 35
50960-XXXX	Short Stool (Specify Color)	14" - 18"H x 13"W x 13"D	2 Days	\$245.87	9, 14, 35
50970-XXXX	Tall Stool (Specify Color)	17" - 24"H x 13"W x 13"D	2 Days	\$248.58	9, 14, 35
83464-XXXX*	Hierarchy Flipz Stool	17.1"H x 12"W x 12"D	5 Days	\$231.47	25, 35
83843	Gloss White	23.6"H x 35.4"W	2 Days	\$192.02	15, 40
83841	Gloss White	47.2"H x 47.2"W	2 Days	\$446.84	15, 40
83844	Gloss White	35.4"H x 47.2"W	2 Days	\$349.21	15, 40
83845	Gloss White	47.2"H x 70.9"W	2 Days	\$676.23	15, 40
83846	Gloss White	47.2"H x 94.5"W	2 Days	\$824.74	15, 40
202AD-25	Porcelain Steel Whiteboard - Deluxe Aluminum Trim	4"H x 4"W	2 Days	\$595.26	11, 15, 40
202AG-25	Porcelain Steel Whiteboard - Deluxe Aluminum Trim	4"H x 6"W	2 Days	\$700.10	11, 15, 40
202AH-25	Porcelain Steel Whiteboard - Deluxe Aluminum Trim	4"H x 8"W	2 Days	\$819.22	11, 15, 40
202AK-25	Porcelain Steel Whiteboard - Deluxe Aluminum Trim	4"H x 10"W	2 Days	\$1,062.33	11, 15, 40
202AM-25	Porcelain Steel Whiteboard - Deluxe Aluminum Trim	4"H x 12"W	2 Days	\$1,129.27	11, 15, 40
202AP-25	Porcelain Steel Whiteboard - Deluxe Aluminum Trim	4"H x 16"W	2 Days	\$1,505.88	11, 15, 40
669RG-DD	Porcelain Steel / Porcelain Steel	4"H x 6"W	2 Days	\$1,615.30	16, 40
669RG-HH	Dura-Rite / Dura-Rite	4"H x 6"W	2 Days	\$1,242.25	16, 40
301AD	Valu-Tak - Aluminum Trim	4"H x 4"W	2 Days	\$297.29	16, 40
301AF	Valu-Tak - Aluminum Trim	4"H x 5"W	2 Days	\$311.73	16, 40
301AG	Valu-Tak - Aluminum Trim	4"H x 6"W	2 Days	\$318.35	16, 40
301AH	Valu-Tak - Aluminum Trim	4"H x 8"W	2 Days	\$355.24	16, 40
84425-WHITE	Hierarchy Grow & Roll Mobile Glass Board (4'H x 3'W) - Low Iron White	52.2"H x 35.7"W x 23.5"D	2 Days	\$1,839.83	10, 17, 40
84425-XXXX	Hierarchy Grow & Roll Mobile Glass Board (4'H x 3'W) - Specify Color	52.2"H x 35.7"W x 23.5"D	2 Days	\$1,596.51	10, 17, 40
84426-WHITE	Hierarchy Grow & Roll Mobile Glass Board (6'H x 4'W) - Low Iron White	73.2"H x 47.6"W x 23.5"D	2 Days	\$2,748.68	10, 17, 40
84426-XXXX	Hierarchy Grow & Roll Mobile Glass Board (6'H x 4'W) - Specify Color	73.2"H x 47.6"W x 23.5"D	2 Days	\$2,599.61	10, 17, 40
27735*	MoorePower® Tower	40"H x 17.5"W x 17.5"D	2 Days	\$723.25	10, 18, 38
781P	Nest Easel - Black	72"H x 34.8"W x 24"D	2 Days	\$794.20	18, 40
785P	Nest Easel - Silver	72"H x 34.8"W x 24"D	2 Days	\$794.20	18, 40
62542	Essentials Mobile Whiteboard - Platinum	71.8"H x 42"W x 21"D	2 Days	\$863.01	18, 40
B3A1X2A1X0	Maxi H2 - Doors + (24) 3" Totes	36.1"H x 42"W x 19.2"D	10 Days	\$2,403.99	9, 32, 33, 38
B3A1X2A1X2	Maxi H2 - Doors + (8) 3" Totes + Left Hand Shelves	36.1"H x 42"W x 19.2"D	10 Days	\$2,282.71	32, 33, 38

PART NO.	DESCRIPTION	DIMENSIONS	LEAD TIME	MSRP	PAGE
B3A1X2D1X0	Maxi H2 - Doors + Shelves	36.1"H x 42"W x 19.2"D	10 Days	\$1,578.79	32, 33, 38
B3A1X1C1X0	Maxi H2 - (12) 3" Totes + (6) 6" Totes	36.1"H x 42"W x 19.2"D	10 Days	\$2,005.00	32, 33, 38
B3A1X1B1X0	Maxi H2 - (12) 6" Totes	36.1"H x 42"W x 19.2"D	10 Days	\$1,829.15	10, 32, 33, 38
B3A1X1A1X0	Maxi H2 - (24) 3" Totes	36.1"H x 42"W x 19.2"D	10 Days	\$2,102.02	32, 33, 38
B3A1X1A1X2	Maxi H2 - (8) 3" Totes + Left Hand Shelves	36.1"H x 42"W x 19.2"D	10 Days	\$1,980.75	32, 33, 38
B3A1X1D1X0	Maxi H2 - Shelves	36.1"H x 42"W x 19.2"D	10 Days	\$1,301.56	32, 33, 38
C3A1X2A1X2	Maxi H3 - Doors + (12) 3" Totes + Left Hand Shelves	51.1"H x 42"W x 19.2"D	10 Days	\$3,030.34	32, 33, 38
C3A1X2B1X0	Maxi H3 - Doors + (18) 6" Totes	51.1"H x 42"W x 19.2"D	10 Days	\$2,727.15	32, 33, 38
C3A1X2A1X0	Maxi H3 - Doors + (36) 3" Totes	51.1"H x 42"W x 19.2"D	10 Days	\$3,212.25	32, 33, 38
C3A1X2F1X0	Maxi H3 - Doors + (9) 3" Totes + (9) 6" Totes + (3) 12" Totes	51.1"H x 42"W x 19.2"D	10 Days	\$3,042.47	32, 33, 38
C3A1X2D1X0	Maxi H3 - Doors + Shelves	51.1"H x 42"W x 19.2"D	10 Days	\$2,727.15	32, 33, 38
C3A1X1A1X2	Maxi H3 - (12) 3" Totes + Left Hand Shelves	51.1"H x 42"W x 19.2"D	10 Days	\$2,595.62	32, 33, 38
C3A1X1B1X0	Maxi H3 - (18) 6" Totes	51.1"H x 42"W x 19.2"D	10 Days	\$2,613.82	32, 33, 38
C3A1X1A1X0	Maxi H3 - (36) 3" Totes	51.1"H x 42"W x 19.2"D	10 Days	\$2,777.53	32, 33, 38
C3A1X1F1X0	Maxi H3 - (9) 3" Totes + (9) 6" Totes + (3) 12" Totes	51.1"H x 42"W x 19.2"D	10 Days	\$2,632.00	32, 33, 38
C3A1X1D1X0	Maxi H3 - Shelves	51.1"H x 42"W x 19.2"D	10 Days	\$1,615.24	32, 33, 38
D3A1X2E1X0	Grande - Doors + Cubbies	60.6"H x 42"W x 19.2"D	10 Days	\$2,285.55	32, 33, 38
D3A1X2D1X0	Grande - Doors + Shelves	60.6"H x 42"W x 19.2"D	10 Days	\$3,022.35	32, 33, 38
D3A1X1E1X0	Grande - Cubbies	60.6"H x 42"W x 19.2"D	10 Days	\$1,796.77	32, 33, 39
D3A1X1D1X0	Grande - Shelves	60.6"H x 42"W x 19.2"D	10 Days	\$1,776.76	32, 33, 38



Follow us:

 [instagram.com/mooreco_inc](https://www.instagram.com/mooreco_inc)

 [pinterest.com/moorecoinc](https://www.pinterest.com/moorecoinc)

 [facebook.com/moorecoinc](https://www.facebook.com/moorecoinc)

 [linkedin.com/company/mooreco-inc](https://www.linkedin.com/company/mooreco-inc)

 twitter.com/moorecoinc

 [youtube.com/moorecoinc](https://www.youtube.com/moorecoinc)

 [tiktok.com/moorecoinc](https://www.tiktok.com/moorecoinc)

Parts of a Plant



NAME THE PARTS

- 1) CELL WALL
- 2) CHLOROPLAST
- 3) CYTOSOL
- 4) NUCLEUS
- 5) VACUOLE
- 6) MITOCHONDRION
- 7) GOLGI APPARATUS
- 8) PLASMID
- 9) RIBOSOME
- 10) CELL MEMBRANE



"If you look at a plant, you will see that it has many parts. Each part has a job to do. The parts of a plant are: Root, Stem, Leaf, Flower, Fruit, and Seed."

Stem

The stem is the part of the plant that supports the leaves and flowers. It also carries water and nutrients from the roots to the rest of the plant.

Microorganism

Microorganisms are tiny living organisms that are too small to see with the naked eye. They can be found everywhere, including in the air, water, and soil.

 **MOORECO™**

2885 Lorraine Avenue | Temple, TX 76501
p: 800.749.2258 | f: 866.888.7483
www.moorecoinc.com