

Owner's Manual & Safety Instructions

Save This Manual Keep this manual for the safety warnings and precautions, assembly, operating, inspection, maintenance and cleaning procedures. Write the product's serial number in the back of the manual near the assembly diagram (or month and year of purchase if product has no number). Keep this manual and the receipt in a safe and dry place for future reference.

17e

PREDATOR[®] E N G I N E S

212cc Horizontal Engine



⚠ DANGER

Using an engine indoors
CAN KILL YOU IN MINUTES.

Engine exhaust contains carbon monoxide.
This is a poison you cannot see or smell.

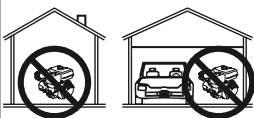

NEVER use inside
a home or garage,
EVEN IF doors and
windows are open.



Only use OUTSIDE
and far away from
windows, doors,
and vents.

Visit our website at: <http://www.harborfreight.com>

Email our technical support at: predator@harborfreight.com

Email our engine support at: predator@harborfreight.com

60363

When unpacking, make sure that the product is intact and undamaged. If any parts are missing or broken, please call 1-888-866-5797 as soon as possible.

Copyright© 2012 by Harbor Freight Tools®. All rights reserved.

No portion of this manual or any artwork contained herein may be reproduced in any shape or form without the express written consent of Harbor Freight Tools. Diagrams within this manual may not be drawn proportionally. Due to continuing improvements, actual product may differ slightly from the product described herein.

Tools required for assembly and service may not be included.

⚠ WARNING

Read this material before using this product.
Failure to do so can result in serious injury.
SAVE THIS MANUAL.

Table of Contents





Specifications	2	Maintenance	10
Safety	3	Troubleshooting	14
Setup	6	Warranties	19
Operation	7	Parts List and Diagram	16

Specifications



Displacement		212cc
Engine Type		Horizontal Single Cylinder 4 stroke OHV Meets EPA phase III emissions standards
Cooling System		Forced air cooled
Fuel	Type	87+ octane stabilizer treated unleaded gasoline
	Capacity	0.9 Gallon (3.6 Liter)
Engine Oil	Type SAE	10W-30 above 32° F 5W-30 at 32° F or below
	Capacity	0.5 Quart
Run Time @ 50% Load with full tank		3 hr.
Sound Level at 22 feet		104 dB
Bore x Stroke		70 mm x 55 mm
Compression Ratio		8.5:1
Rotation viewed from PTO (power takeoff - the output shaft)		Counterclockwise
Shaft	Shaft	3/4" x 2.43"
	Keyway	3/16" (4.76 mm)
	End Tapped	5/16" - 24 UNF
Spark Plug	Type	NGK® BP-6ES NHSP® / Torch® F6TC
	Gap	0.0275" - 0.0314"
Valve Clearance	Intake	0.0039" - 0.0059"
	Exhaust	0.0039" - 0.0059"
Speed	Idle	1,800 ± 150 RPM



PREDATOR® E N G I N E S

WARNING SYMBOLS AND DEFINITIONS

	This is the safety alert symbol. It is used to alert you to potential personal injury hazards. Obey all safety messages that follow this symbol to avoid possible injury or death.
	Indicates a hazardous situation which, if not avoided, will result in death or serious injury.
	Indicates a hazardous situation which, if not avoided, could result in death or serious injury.
	Indicates a hazardous situation which, if not avoided, could result in minor or moderate injury.
	Addresses practices not related to personal injury.

Symbol Definitions

Symbol	Property or Statement
RPM	Revolutions Per Minute
HP	Horsepower
	WARNING marking concerning Risk of Eye Injury. Wear ANSI-approved safety goggles with side shields.
	Read the manual before set-up and/or use.
	WARNING marking concerning Risk of Hearing Loss. Wear hearing protection.

Symbol	Property or Statement
	WARNING marking concerning Risk of Respiratory Injury. Operate engine OUTSIDE and far away from windows, doors, and vents.
	WARNING marking concerning Risk of Fire while handling fuel. Do not smoke while handling fuel.
	WARNING marking concerning Risk of Fire. Do not refuel while operating. Keep flammable objects away from engine.

Safety Warnings



WARNING! Read all instructions.

Failure to follow all instructions listed below may result in fire, serious injury and/or DEATH.

The warnings and precautions discussed in this manual cannot cover all possible conditions and situations that may occur. It must be understood by the operator that common sense and caution are factors which cannot be built into this product, but must be supplied by the operator.

SAVE THESE INSTRUCTIONS

Set up Precautions

1. Gasoline fuel and fumes are flammable, and potentially explosive. Use proper fuel storage and handling procedures. Do not store fuel or other flammable materials nearby.
2. Have multiple ABC class fire extinguishers nearby.
3. Operation of this equipment may create sparks that can start fires around dry vegetation. A spark arrestor may be required. The operator should contact local fire agencies for laws or regulations relating to fire prevention requirements.
4. Set up and use only on a flat, level, well-ventilated surface.
5. Wear ANSI-approved safety goggles, heavy-duty work gloves, and dust mask/respirator during set up.
6. Use only lubricants and fuel recommended in the Specifications chart of this manual.

Operating Precautions

1.  **CARBON MONOXIDE HAZARD**
Using an engine indoors CAN KILL YOU IN MINUTES.
Engine exhaust contains carbon monoxide. This is a poison you cannot see or smell.

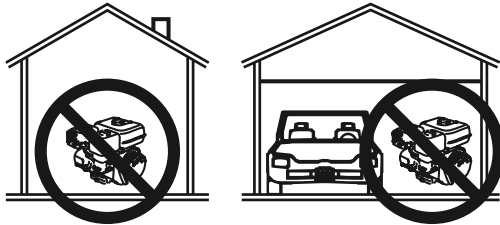

NEVER use inside a home or garage, EVEN IF doors and windows are open.

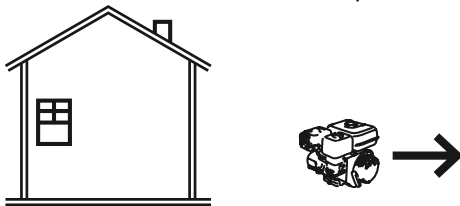

Only use OUTSIDE and far away from windows, doors, and vents.

1. Keep children away from the equipment, especially while it is operating.
2. Keep all spectators at least six feet from the Engine during operation.
3. Fire Hazard! Do not fill gas tank while engine is running. Do not operate if gasoline has been spilled. Clean spilled gasoline before starting engine. Do not operate near pilot light or open flame.
4. Do not touch engine during use. Let engine cool down after use.
5. Never store fuel or other flammable materials near the engine.
6. Only use a suitable means of transport and lifting devices with sufficient weight bearing capacity when transporting the Engine.
7. Secure the Engine on transport vehicles to prevent the tool from rolling, slipping, and tilting.
8. Industrial applications must follow OSHA requirements.
9. Do not leave the equipment unattended when it is running. Turn off the equipment (and remove safety keys, if available) before leaving the work area.
10. Engine can produce high noise levels. Prolonged exposure to noise levels above 85 dBA is hazardous to hearing. Always wear ear protection when operating or working around the gas engine while it is operating.
11. Wear ANSI-approved safety glasses, hearing protection, and NIOSH-approved dust mask/respirator under a full face shield along with steel-toed work boots during use.
12. People with pacemakers should consult their physician(s) before use. Electromagnetic fields in close proximity to a heart pacemaker could cause pacemaker interference or pacemaker failure. Caution is necessary when near the engine's magneto or recoil starter.
13. Use only accessories that are recommended by Harbor Freight Tools for your model. Accessories that may be suitable for one piece of equipment may become hazardous when used on another piece of equipment.
14. Do not operate in explosive atmospheres, such as in the presence of flammable liquids, gases, or dust. Gasoline-powered engines may ignite the dust or fumes.
15. Stay alert, watch what you are doing and use common sense when operating this piece of equipment. Do not use this piece of equipment while tired or under the influence of drugs, alcohol or medication.
16. Do not overreach. Keep proper footing and balance at all times. This enables better control of the equipment in unexpected situations.
17. Use this equipment with both hands only. Using equipment with only one hand can easily result in loss of control.
18. Dress properly. Do not wear loose clothing or jewelry. Keep hair, clothing and gloves away from moving parts. Loose clothes, jewelry or long hair can be caught in moving parts.

Operating Precautions (cont.)

19. Parts, especially exhaust system components, get very hot during use. Stay clear of hot parts.
20. Do not cover the engine or equipment during operation.
21. Keep the equipment, engine, and surrounding area clean at all times.
22. Do not smoke, or allow sparks, flames, or other sources of ignition around the equipment, especially when refuelling.
23. Use the equipment, accessories, etc., in accordance with these instructions and in the manner intended for the particular type of equipment, taking into account the working conditions and the work to be performed. Use of the equipment for operations different from those intended could result in a hazardous situation.
24. Do not operate the equipment with known leaks in the engine's fuel system.
25. When spills of fuel or oil occur, they must be cleaned up immediately. Dispose of fluids and cleaning materials as per any local, state, or federal codes and regulations. Store oil rags in a bottom-ventilated, covered, metal container.
26. Keep hands and feet away from moving parts. Do not reach over or across equipment while operating.
27. Before use, check for misalignment or binding of moving parts, breakage of parts, and any other condition that may affect the equipment's operation. **If damaged, have the equipment serviced before using.** Many accidents are caused by poorly maintained equipment.
28. Use the correct equipment for the application. Do not modify the equipment and do not use the equipment for a purpose for which it is not intended.

Service Precautions

1. **Before service, maintenance, or cleaning:**
 - a. **Turn the engine switch to its "OFF" position.**
 - b. **Allow the engine to completely cool.**
 - c. **Then, remove the spark plug cap from the spark plug.**
2. Keep all safety guards in place and in proper working order. Safety guards include muffler, air cleaner, mechanical guards, and heat shields, among other guards.
3. **Do not alter or adjust any part of the equipment or its engine that is sealed by the manufacturer or distributor. Only a qualified service technician may adjust parts that may increase or decrease governed engine speed.**
4. Wear ANSI-approved safety goggles, heavy-duty work gloves, and dust mask/respirator during service.
5. Maintain labels and nameplates on the equipment. These carry important information. If unreadable or missing, contact Harbor Freight Tools for a replacement.
6. Have the equipment serviced by a qualified repair person using only identical replacement parts. This will ensure that the safety of the equipment is maintained. Do not attempt any service or maintenance procedures not explained in this manual or any procedures that you are uncertain about your ability to perform safely or correctly.
7. Store equipment out of the reach of children.

8. Follow scheduled engine and equipment maintenance.

Refueling:

1. Do not refill the fuel tank while the engine is running or hot.
2. Do not smoke, or allow sparks, flames, or other sources of ignition around the equipment, especially when refuelling.
3. **TO PREVENT FUEL LEAKAGE AND FIRE HAZARD, do not fill fuel above the bottom of fuel strainer.**

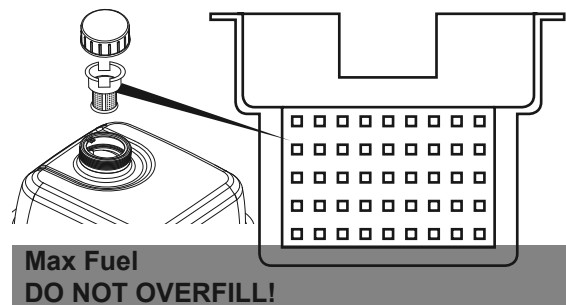

4. Do not fill fuel tank to the top. Leave a little room for the fuel to expand as needed.
5. Refuel in a well-ventilated area only.
6. Wipe up any spilled fuel and allow excess to evaporate before starting engine. **To prevent FIRE, do not start the engine while the smell of fuel hangs in the air.**



SAVE THESE INSTRUCTIONS.

Set Up



Read the **ENTIRE IMPORTANT SAFETY INFORMATION** section at the beginning of this manual including all text under subheadings therein before set up or use of this product.

WARNING

TO PREVENT SERIOUS INJURY:
Operate only with proper spark arrestor installed.

Operation of this equipment may create sparks that can start fires around dry vegetation. A spark arrestor may be required. The operator should contact local fire agencies for laws or regulations relating to fire prevention requirements.

At high altitudes, the engine's carburetor, governor (if so equipped), and any other parts that control the

fuel-air ratio will need to be adjusted by a qualified mechanic to allow efficient high-altitude use and to prevent damage to the engine and any other devices used with this product.

The emission control system for this Engine is warranted for standards set by the U.S. Environmental Protection Agency. For warranty information, refer to the last pages of this manual.

WARNING! DO NOT INSTALL THIS ENGINE ON A VEHICLE. NOT FOR HIGHWAY USE. FOLLOW ALL APPLICABLE LAWS FOR INSTALLATION AND USE.

Engine Controls

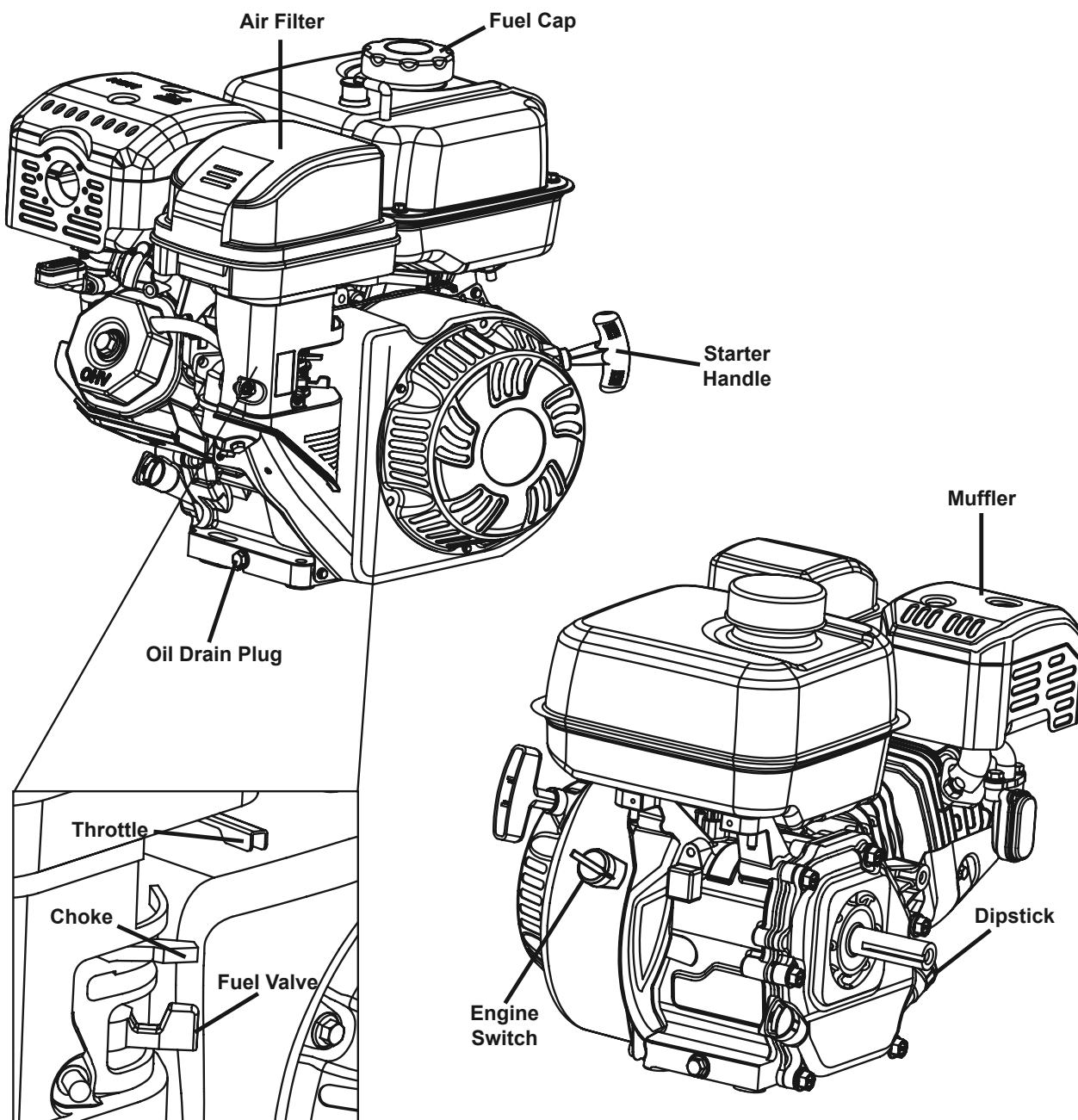

Operation



Read the **ENTIRE IMPORTANT SAFETY INFORMATION** section at the beginning of this manual including all text under subheadings therein before set up or use of this product.

Pre-Start Checks

Inspect engine and equipment looking for damaged, loose, and missing parts before set up and starting. If any problems are found, do not use equipment until fixed properly.

Checking and Filling Engine Oil

NOTICE: Your Warranty is VOID if the engine's crankcase is not properly filled with oil before each use. Before each use, check the oil level. Engine will not start with low or no engine oil.

1. Make sure the engine is stopped and is level.
2. Close the Fuel Valve.
3. Clean the top of the Dipstick and the area around it. Remove the Dipstick by turning it counterclockwise, and wipe it off with a clean, lint free rag.

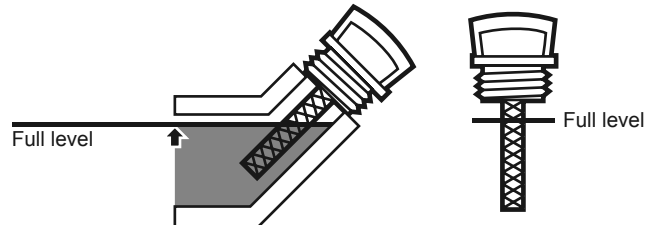

4. Reinsert the Dipstick without threading it in and remove it to check the oil level. The oil level should be up to the full level as shown above.
5. If the oil level is at or below the low mark add the appropriate type of oil until the oil level is at the proper level. SAE 10W-30 oil is recommended for general use. (The SAE Viscosity Grade chart on page 11 in the Maintenance section shows other viscosities to use in different average temperatures.)
6. Thread the dipstick back in clockwise.

NOTICE: Do not run the engine with too little oil. Engine will shut off if engine oil level is too low.

Checking and Filling Fuel



WARNING! TO PREVENT SERIOUS INJURY FROM FIRE:

Fill the fuel tank in a well-ventilated area away from ignition sources. If the engine is hot from use, shut the engine off and wait

for it to cool before adding fuel. Do not smoke.

1. Clean the Fuel Cap and the area around it.
2. Unscrew and remove the Fuel Cap.
3. If needed, fill the Fuel Tank to about 1 inch under the fill neck with 87 octane or higher unleaded gasoline that has been treated with a fuel stabilizer additive. Follow fuel stabilizer manufacturer's recommendations for use.

Note: Do not use gasoline containing more than 10% ethanol (E10). Do not use E85 ethanol.

Note: Do not use gasoline that has been stored in a metal fuel container or a dirty fuel container. It can cause particles to enter the carburetor, affecting engine performance and/or causing damage.

4. Then replace the Fuel Cap.
5. Wipe up any spilled fuel and allow excess to evaporate before starting engine. To prevent FIRE, do not start the engine while the smell of fuel hangs in the air.

Starting the Engine

Before Starting the Engine



Before starting the engine:

- Follow the Set Up Instructions in the equipment manual to prepare the equipment.
- Inspect the equipment and engine.
- Fill the engine with the proper amount and type of both fuel and oil.
- Read the Equipment Operation section in the equipment manual.

- To start a cold engine, move the Choke to the CHOKE position.
To restart a warm engine, leave the Choke in the RUN position.

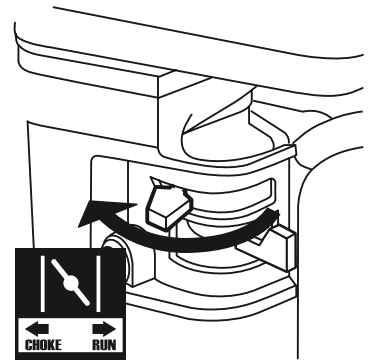

- Open the Fuel Valve.

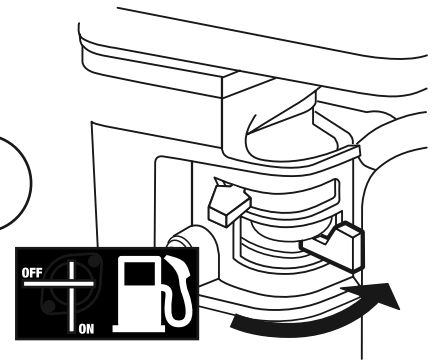
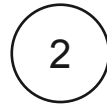

- Slide the Throttle or Speed Control Lever to 1/3 away from the SLOW position (the "turtle").

Note: Some tools have a Speed Control Lever located elsewhere on the tool which functions the same as the Throttle. Use the Speed Control Lever in place of the Throttle when the tool is so equipped.



- Turn the Engine Switch on.

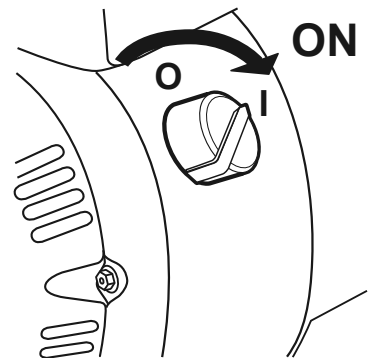
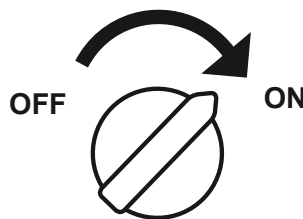

Note: If engine does not start, check engine oil level. Engine will not start with low or no engine oil.

5. Grip the Starter Handle of the Engine loosely and pull it slowly several times to allow the gasoline to flow into the Engine's carburetor. Then pull the Starter Handle gently until resistance is felt. Allow Cable to retract fully and then pull it quickly. Repeat until the engine starts.

Note: Do not let the Starter Handle snap back against the engine. Hold it as it recoils so it doesn't hit the engine.

6. Allow the Engine to run for several seconds. Then, if the Choke lever is in the CHOKE position, move the Choke Lever very slowly to its RUN position.

Note: Moving the Choke Lever too fast could stall the engine.

IMPORTANT: Allow the engine to run at no load for five minutes with no load after each start-up so that the engine can stabilize.

7. Adjust the Throttle as needed.

8. **Break-in Period:**

- a. Breaking-in the engine will help to ensure proper equipment and engine operation.
- b. The operational break-in period will last about 3 hours of use. During this period:
 - Do not apply a heavy load to the equipment.
 - Do not operate the engine at its maximum speed.
- c. The maintenance break-in period will last about 20 hours of use. After this period:
 - Change the engine oil.

Under normal operating conditions subsequent maintenance follows the schedule explained in the MAINTENANCE AND SERVICING section.

Stopping the Engine

1. To stop the engine in an emergency, turn the Engine Switch off.
2. Under normal conditions, use the following procedure:
 - a. Slide the Throttle or Speed Control Lever to SLOW (the "turtle").
 - b. Turn the Engine Switch off.
 - c. Close the Fuel Valve.

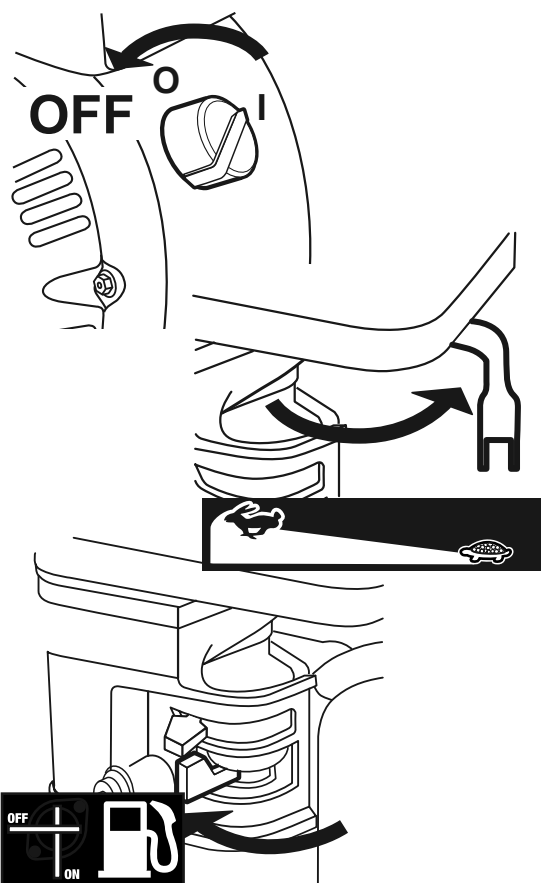
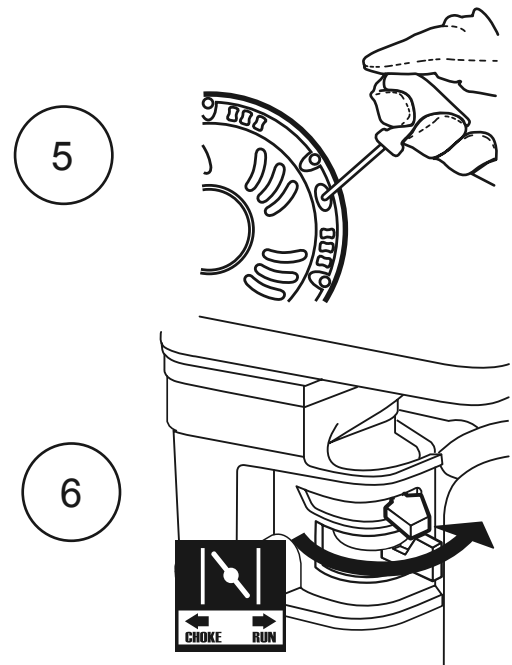

⚠ WARNING

TO PREVENT SERIOUS INJURY FROM ACCIDENTAL STARTING:

Turn the Power Switch of the equipment to its “OFF” position, wait for the engine to cool, and disconnect the spark plug cap before performing any inspection, maintenance, or cleaning procedures.

TO PREVENT SERIOUS INJURY FROM EQUIPMENT FAILURE:

Do not use damaged equipment. If abnormal noise, vibration, or excess smoking occurs, have the problem corrected before further use.

Follow all service instructions in this manual. The engine may fail critically if not serviced properly.



Many maintenance procedures, including any not detailed in this manual, will need to be performed by a qualified technician for safety. If you have any doubts about your ability to safely service the equipment or engine, have a qualified technician service the equipment instead.

Cleaning, Maintenance, and Lubrication Schedule

Note: This maintenance schedule is intended solely as a general guide. If performance decreases or if equipment operates unusually, check systems immediately. The maintenance needs of each piece of equipment will differ depending on factors such as duty cycle, temperature, air quality, fuel quality, and other factors.

Note: The following procedures are in addition to the regular checks and maintenance explained as part of the regular operation of the engine and equipment.

Procedure	Before Each Use	Monthly or every 20 hr. of use	Every 3 mo. or 50 hr. of use	Every 6 mo. or 100 hr. of use	Yearly or every 300 hr. of use	Every 2 Years
Brush off outside of engine	✓	✓	✓	✓	✓	✓
Check engine oil level	✓	✓	✓	✓	✓	✓
Check air cleaner	✓		✓	✓	✓	✓
Check deposit cup	✓			✓	✓	✓
Change engine oil		✓		✓	✓	✓
Clean/replace air cleaner			✓*	✓	✓	✓
Check and clean spark plug				✓	✓	✓
1. Check/adjust idle speed 2. Check/adjust valve clearance 3. Clean fuel tank, strainer and carburetor 4. Clean carbon build-up from combustion chamber					✓**	✓**
Replace fuel line if necessary						✓**

*Service more frequently when used in dusty areas.

**These items should be serviced by a qualified technician.

PREDATOR
E N G I N E S

Checking and Filling Fuel



⚠️WARNING! TO PREVENT SERIOUS INJURY FROM FIRE:

Fill the fuel tank in a well-ventilated area away from ignition sources. If the engine is hot from use, shut the engine off and wait for it to cool before adding fuel. Do not smoke.

1. Clean the Fuel Cap and the area around it.
2. Unscrew and remove the Fuel Cap.
3. If needed, fill the Fuel Tank to about 1 inch under the fill neck with 87 octane or higher unleaded gasoline that has been treated with a fuel stabilizer additive. Follow fuel stabilizer manufacturer's recommendations for use. Fill to the bottom of the fuel strainer ONLY, see below.

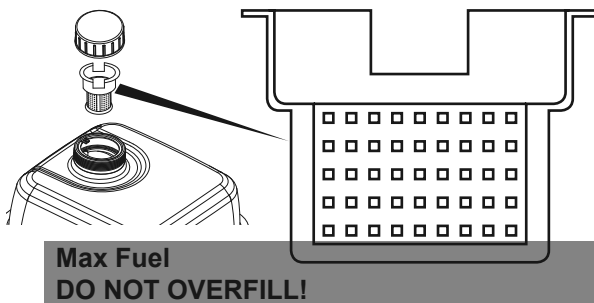

⚠️WARNING! TO PREVENT FUEL LEAKAGE AND FIRE HAZARD, do not fill fuel above the bottom of fuel strainer.

Note: Do not use gasoline containing more than 10% ethanol (E10). Do not use E85 ethanol.

Note: Do not use gasoline that has been stored in a metal fuel container or a dirty fuel container. It can cause particles to enter the carburetor, affecting engine performance and/or causing damage.

4. Then replace the Fuel Cap.
5. Wipe up any spilled fuel and allow excess to evaporate before starting engine. To prevent FIRE, do not start the engine while the smell of fuel hangs in the air.

Engine Oil Change

⚠️CAUTION! Oil is very hot during operation and can cause burns. Wait for engine to cool before changing oil.

1. Make sure the engine is stopped and is level.
2. Close the Fuel Valve.
3. Place a drain pan (not included) underneath the crankcase's drain plug.
4. Remove the drain plug and, if possible, tilt the crankcase slightly to help drain the oil out. Recycle used oil.
5. Replace the drain plug and tighten it.
6. Clean the top of the Dipstick and the area around it. Remove the Dipstick by turning it counterclockwise, and wipe it off with a clean, lint free rag.

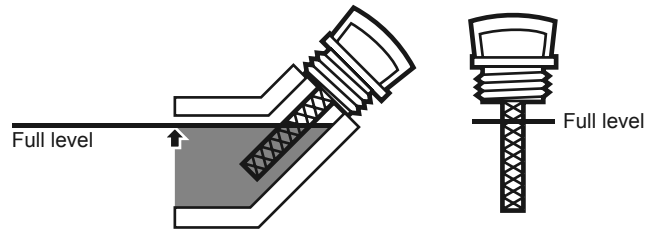

7. Add the appropriate type of oil until the oil level is at the full level. SAE 10W-30 oil is recommended for general use. The SAE Viscosity Grade chart shows other viscosities to use in different average temperatures.

SAE Viscosity Grades

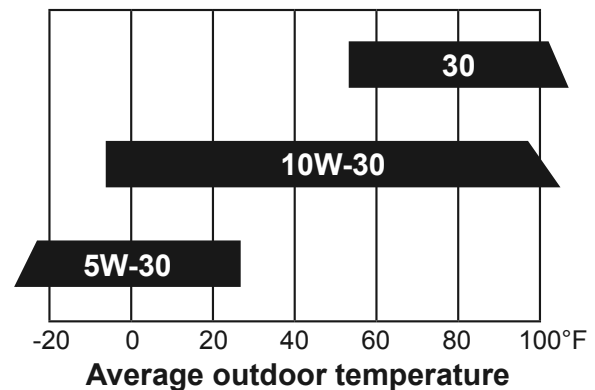

8. Thread the dipstick back in clockwise.

NOTICE: Do not run the engine with too little oil. Engine will not start with low or no engine oil.

PREDATOR[®]

ENGINES

Air Filter Element Maintenance

1. Remove the air filter cover and the air filter elements and check for dirt. Clean as described below.
2. **Cleaning:**
 - For “paper” filter elements:
To prevent injury from dust and debris, wear ANSI-approved safety goggles, NIOSH-approved dust mask/respirator, and heavy-duty work gloves. In a well-ventilated area away from bystanders, use pressurized air to blow dust out of the air filter.
 - For foam filter elements:
Wash the element in warm water and mild detergent several times. Rinse. Squeeze out excess water and allow it to dry completely. Soak the filter in lightweight oil briefly, then squeeze out the excess oil.
3. Install the cleaned filter. Secure the Air Cleaner Cover before use.

Spark Plug Maintenance

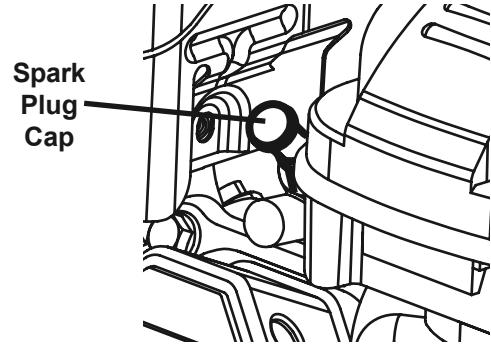

1. Disconnect spark plug cap from end of plug. Clean out debris from around spark plug.
2. Using a spark plug wrench, remove the spark plug.
3. Inspect the spark plug:
If the electrode is oily, clean it using a clean, dry rag. If the electrode has deposits on it, polish it using emery paper. If the white insulator is cracked or chipped, the spark plug needs to be replaced.

Recommended Spark Plugs

NGK®	BP-6ES
NHSP® / TORCH®	F6TC

NOTICE: Using an incorrect spark plug may damage the engine.

4. When installing a new spark plug, adjust the plug's gap to the specification on the Technical Specifications chart. Do not pry against the electrode, the spark plug can be damaged.
5. Install the new spark plug or the cleaned spark plug into the engine. Gasket-style: Finger-tighten until the gasket contacts the cylinder head, then tighten about 1/2-2/3 turn more.
Non-gasket-style: Finger-tighten until the plug contacts the head, then tighten about 1/16 turn more.

NOTICE: Tighten the spark plug properly. If loose, the spark plug will cause the engine to overheat.

If overtightened, the threads in the engine block will be damaged.

6. Apply dielectric spark plug boot protector (not included) to the end of the spark plug and reattach the wire securely.

PREDATOR[®]

ENGINE S

Storage

When the equipment is to remain idle for longer than 20 days, prepare the Engine for storage as follows:

1. **CLEANING:**

Wait for Engine to cool, then clean Engine with dry cloth. **NOTICE: Do not clean using water.** The water will gradually enter the Engine and cause rust damage. Apply a thin coat of rust preventive oil to all metal parts.

2. **FUEL:**

To protect the fuel tank during storage, fill the tank with gasoline that has been treated with a fuel stabilizer additive. Follow fuel stabilizer manufacturer's recommendations for use. Refer to "Checking and Filling Fuel" on page 7.



⚠️ WARNING! TO PREVENT SERIOUS INJURY FROM FIRE:

Fill tank in a well-ventilated area away from ignition sources. If the engine is hot from use, shut the engine off and wait for it to cool before adding fuel. Do not smoke.

3. **LUBRICATION:**

- a. Change engine oil.
- b. Clean out area around spark plug.
Remove spark plug and pour one tablespoon of engine oil into cylinder through spark plug hole.

- c. Replace spark plug, but leave spark plug cap disconnected.
- d. Pull Starter Handle to distribute oil in cylinder. Stop after one or two revolutions when you feel the piston start the compression stroke (when you start to feel resistance).

4. **BATTERY:**

Disconnect battery cables (if equipped). Recharge batteries monthly while in storage.

5. **STORAGE AREA:**

Cover and store in a dry, level, well-ventilated area out of reach of children. Storage area should also be away from ignition sources, such as water heaters, clothes dryers, and furnaces.

NOTICE: During extended storage periods the Engine must be started every 3 months and allowed to run for 15–20 minutes or the Warranty is VOID.

6. **AFTER STORAGE:**

Before starting the Engine during or after storage, keep in mind that untreated gasoline will deteriorate quickly. Drain the fuel tank and change to fresh fuel if untreated gasoline has been sitting for a month, if treated gasoline has been sitting beyond the fuel stabilizer's recommended time period, or if the Engine does not start.

PREDATOR[®]

ENGINES

Troubleshooting

SAFETY

SETUP

OPERATION

MAINTENANCE

Problem	Possible Causes	Probable Solutions
Engine will not start	FUEL RELATED: <ol style="list-style-type: none"> No fuel in tank or fuel valve closed. Choke not in START position, cold engine. Gasoline with more than 10% ethanol used. (E15, E20, E85, etc.) Low quality or deteriorated, old gasoline. Carburetor not primed. Dirty fuel passageways. Carburetor needle stuck. Fuel can be smelled in the air. Too much fuel in chamber. This can be caused by the carburetor needle sticking. Clogged Fuel Filter. 	FUEL RELATED: <ol style="list-style-type: none"> Fill fuel tank with fresh 87+ octane stabilizer-treated unleaded gasoline and open fuel valve. Do not use gasoline with more than 10% ethanol (E15, E20, E85, etc.). Move Choke to START position. Clean out ethanol rich gasoline from fuel system. Replace components damaged by ethanol. Use fresh 87+ octane stabilizer-treated unleaded gasoline only. Do not use gasoline with more than 10% ethanol (E15, E20, E85, etc.). Use fresh 87+ octane stabilizer-treated unleaded gasoline. Do not use gasoline with more than 10% ethanol (E15, E20, E85, etc.). Pull on Starter Handle to prime. Clean out passageways using fuel additive. Heavy deposits may require further cleaning. Gently tap side of carburetor float chamber with screwdriver handle. Turn Choke to RUN position. Remove spark plug and pull the start handle several times to air out the chamber. Reinstall spark plug and set Choke to START position. Replace Fuel Filter.
	IGNITION (SPARK) RELATED: <ol style="list-style-type: none"> Spark plug cap not connected securely. Spark plug electrode wet or dirty. Incorrect spark plug gap. Spark plug cap broken. Incorrect spark timing or faulty ignition system. 	IGNITION (SPARK) RELATED: <ol style="list-style-type: none"> Connect spark plug cap properly. Clean spark plug. Correct spark plug gap. Replace spark plug cap. Have qualified technician diagnose/repair ignition system.
	COMPRESSION RELATED: <ol style="list-style-type: none"> Cylinder not lubricated. Problem after long storage periods. Loose or broken spark plug. (Hissing noise will occur when trying to start.) Loose cylinder head or damaged head gasket. (Hissing noise will occur when trying to start.) Engine valves or tappets mis-adjusted or stuck. 	COMPRESSION RELATED: <ol style="list-style-type: none"> Pour tablespoon of oil into spark plug hole. Crank engine a few times and try to start again. Tighten spark plug. If that does not work, replace spark plug. If problem persists, may have head gasket problem, see #3. Tighten head. If that does not remedy problem, replace head gasket. Have qualified technician adjust/repair valves and tappets.
	ENGINE OIL RELATED: <ol style="list-style-type: none"> Low engine oil. Engine mounted on slope, triggering low oil shutdown. 	ENGINE OIL RELATED: <ol style="list-style-type: none"> Fill engine oil to proper level. Check engine oil before EVERY use. Operate engine on level surface. Check engine oil level.



Follow all safety precautions whenever diagnosing or servicing the equipment or engine.

Problem	Possible Causes	Probable Solutions
Engine misfires	<ol style="list-style-type: none"> 1. Spark plug cap loose. 2. Incorrect spark plug gap or damaged spark plug. 3. Defective spark plug cap. 4. Old or low quality gasoline. 5. Incorrect compression. 	<ol style="list-style-type: none"> 1. Check cap and wire connections. 2. Re-gap or replace spark plug. 3. Replace spark plug cap. 4. Use only fresh 87+ octane stabilizer-treated unleaded gasoline. Do not use gasoline with more than 10% ethanol (E15, E20, E85, etc.). 5. Diagnose and repair compression. (Use Engine will not start: COMPRESSION RELATED section.)
Engine stops suddenly	<ol style="list-style-type: none"> 1. Fuel tank empty or full of impure or low quality gasoline. 2. Low oil shutdown. 3. Defective fuel tank cap creating vacuum, preventing proper fuel flow. 4. Faulty magneto. 5. Disconnected or improperly connected spark plug cap. 	<ol style="list-style-type: none"> 1. Fill fuel tank with fresh 87+ octane stabilizer-treated unleaded gasoline. Do not use gasoline with more than 10% ethanol (E15, E20, E85, etc.). 2. Fill engine oil to proper level. Check engine oil before EVERY use. 3. Test/replace fuel tank cap. 4. Have qualified technician service magneto. 5. Secure spark plug cap.
Engine stops when under heavy load	<ol style="list-style-type: none"> 1. Dirty air filter 2. Engine running cold. 	<ol style="list-style-type: none"> 1. Clean element. 2. Allow engine to warm up prior to operating equipment.
Engine knocks	<ol style="list-style-type: none"> 1. Old or low quality gasoline. 2. Engine overloaded. 3. Incorrect spark timing, deposit buildup, worn engine, or other mechanical problems. 	<ol style="list-style-type: none"> 1. Fill fuel tank with fresh 87+ octane stabilizer-treated unleaded gasoline. Do not use gasoline with more than 10% ethanol (E15, E20, E85, etc.). 2. Do not exceed equipment's load rating. 3. Have qualified technician diagnose and service engine.
Engine backfires After sudden impact, engine will run, but equipment will not operate	<ol style="list-style-type: none"> 1. Impure or low quality gasoline. 2. Engine too cold. 3. Intake valve stuck or overheated engine. 4. Incorrect timing. Shaft key or other shear pin broken by impact to disconnect engine and limit damage.	<ol style="list-style-type: none"> 1. Fill fuel tank with fresh 87+ octane stabilizer-treated unleaded gasoline. Do not use gasoline with more than 10% ethanol (E15, E20, E85, etc.). 2. Use cold weather fuel and oil additives to prevent backfiring. 3. Have qualified technician diagnose and service engine. 4. Check engine timing. Have qualified technician check and replace broken shaft key or other shear pins.



Follow all safety precautions whenever diagnosing or servicing the equipment or engine.

PLEASE READ THE FOLLOWING CAREFULLY

THE MANUFACTURER AND/OR DISTRIBUTOR HAS PROVIDED THE PARTS LIST AND ASSEMBLY DIAGRAM IN THIS MANUAL AS A REFERENCE TOOL ONLY. NEITHER THE MANUFACTURER OR DISTRIBUTOR MAKES ANY REPRESENTATION OR WARRANTY OF ANY KIND TO THE BUYER THAT HE OR SHE IS QUALIFIED TO MAKE ANY REPAIRS TO THE PRODUCT, OR THAT HE OR SHE IS QUALIFIED TO REPLACE ANY PARTS OF THE PRODUCT. IN FACT, THE MANUFACTURER AND/OR DISTRIBUTOR EXPRESSLY STATES THAT ALL REPAIRS AND PARTS REPLACEMENTS SHOULD BE UNDERTAKEN BY CERTIFIED AND LICENSED TECHNICIANS, AND NOT BY THE BUYER. THE BUYER ASSUMES ALL RISK AND LIABILITY ARISING OUT OF HIS OR HER REPAIRS TO THE ORIGINAL PRODUCT OR REPLACEMENT PARTS THERETO, OR ARISING OUT OF HIS OR HER INSTALLATION OF REPLACEMENT PARTS THERETO.

Parts List and Diagram

Parts List

Part	Description	Qty
1	Bolt, Flange	6
2	Cover, Head	1
3	Asm., Head Cover	1
4	Tube, Breather	1
5	Oil Strainer	1
6	Asm., Breather Cover	1
7	Cover, Breather	1
8	Bolt, Flange	4
9	Cylinder Head	1
10	Spark Plug	1
11	Stud	2
12	Gasket, Cylinder	1
13	Pin, Dowel	2
14	Rocker Arm Asm.	2
15	Valve Rocker Shaft	2
16	Rotator, Valve	2
17	Retainer, Valve Spring	2
18	Spring, Valve	2
19	Seal, Valve Stem	1
20	Push Rod	2
21	Lifter Valve	2
22	Valve Asm.	1
23	Camshaft Asm.	1
24	Flat Washer	2
25	Bolt, Drain Plug	2
26	Crankcase	1
27	Oil Sensor	1
28	Bolt, Flange	7
29	Cable Cleat	1
30	Oil Seal	2
31	Bearing	2
32	Governor Kit	1
33	Ring Set, Piston	1
34	Piston	1
35	Pin, Piston	1
36	Clip, Piston Pin	2
37	Conn. Rod Asm.	1
38	Crankshaft	1
39	Packing, Case Cover	1
40	Pin, Dowel	2
41	Cover Asm., Crankcase	1
42	Cap Asm.	2
43	Bolt, Flange	6
44	Shroud	1
45	Bolt, Flange	2
46	Switch Asm., Oil Level	1
47	Stud	2

Part	Description	Qty
48	Packing, Carburetor	1
49	Insulator, Carburetor	1
50	Packing, Carburetor	1
51	Carburetor	1
52	Packing, Carburetor	1
53	Air Cleaner Asm.	1
54	Element Asm., Air Cleaner	1
55	Nut, Flange	2
56	Plate, Side	1
57	Bolt, Flange	1
58	Clip, Harness	1
59	Coil Asm., Ignition	1
60	Bolt, Flange	2
61	Flywheel	1
62	Fan, Cooling	1
63	Pulley, Starter	1
64	Nut, Flange	1
65	Recoil Starter	1
66	Starter Asm.	1
67	Switch Asm., Engine Stop	1
68	Shaft, Governor Arm	1
69	Pin, Lock	1
70	Flat Washer	1
71	Control Asm.	1
72	Spring, Governor	1
73	Spring, Throttle Return	1
74	Rod, Governor	1
75	Arm, Governor	1
76	Bolt, Governor Arm	1
77	Nut, Flange	1
78	Muffler Asm.	1
79	Gasket, Exhaust Pipe	1
80	Nut	2
81	Tank, Fuel	1
82	Fuel Cap	1
83	Filter, Fuel	1
84	Gas Valve, Fuel Tank	1
85	Joint Asm., Fuel Tank	1
86	Washer, Rubber	2
87	Nut, Flange	2
88	Bolt, Flange	1
89	Tube, Fuel	1
90	Loop, Tube	2
91	Pipe	1
92	Loop, Tube	1
97	Key	1
98	Locker	4

Assembly Diagram

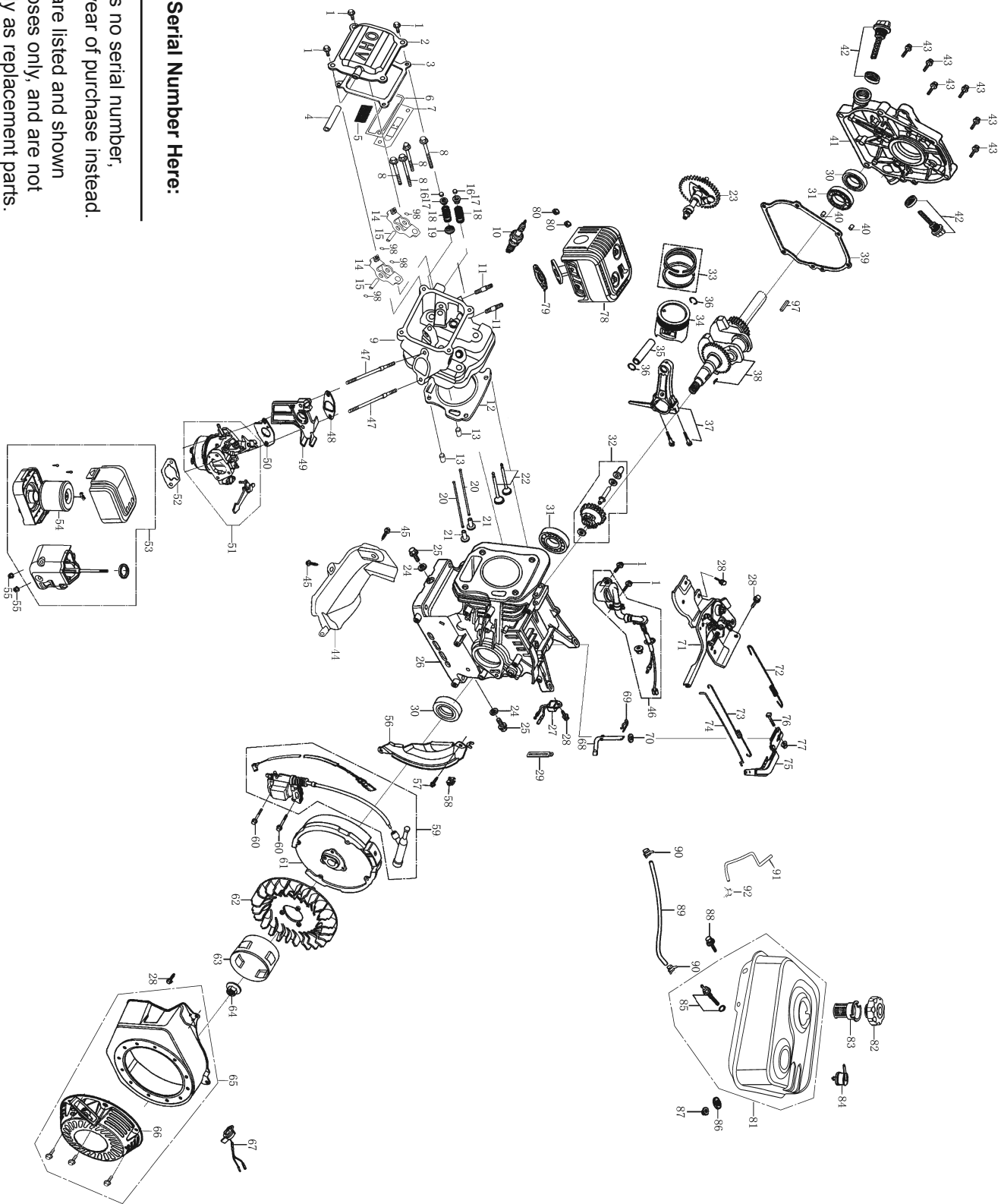

Record Product's Serial Number Here:

Note: If product has no serial number, record month and year of purchase instead.

Note: Some parts are listed and shown for illustration purposes only, and are not available individually as replacement parts.

Mounting Diagrams

Note: Diagrams not to scale.

SAFETY

SETUP

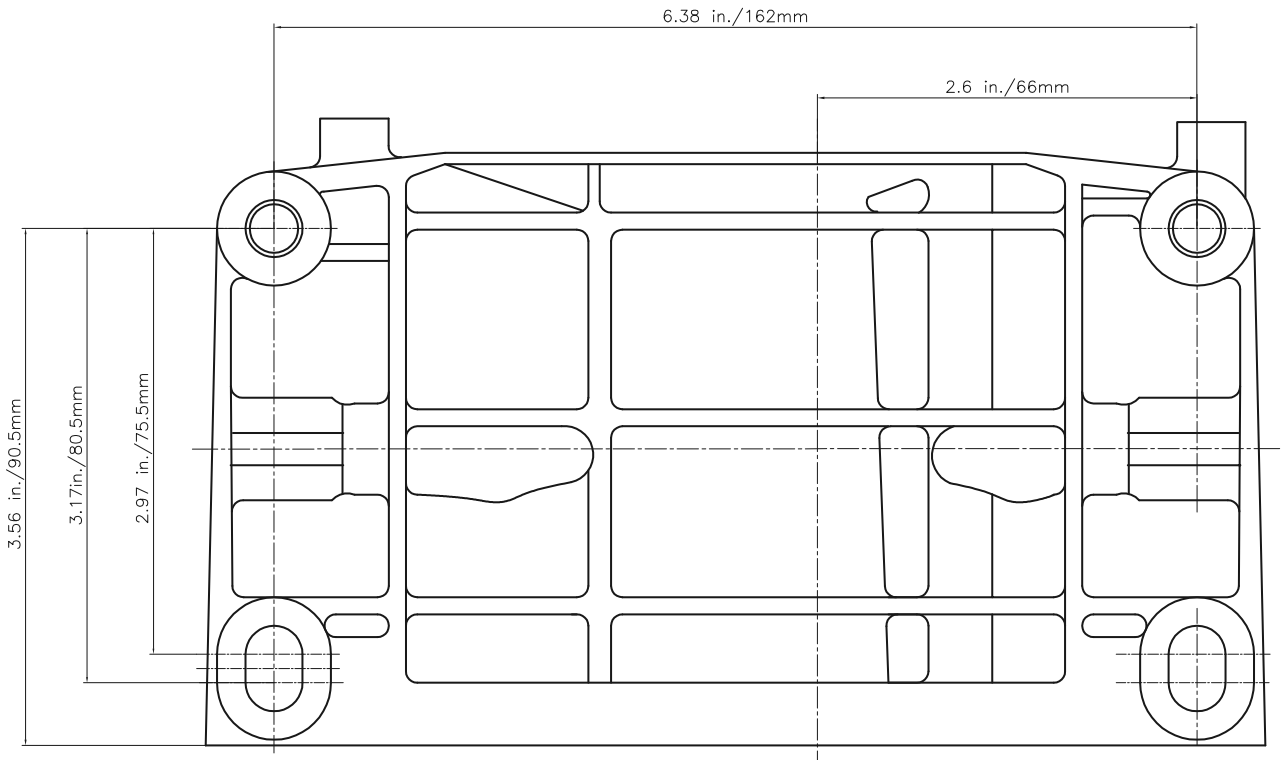

OPERATION

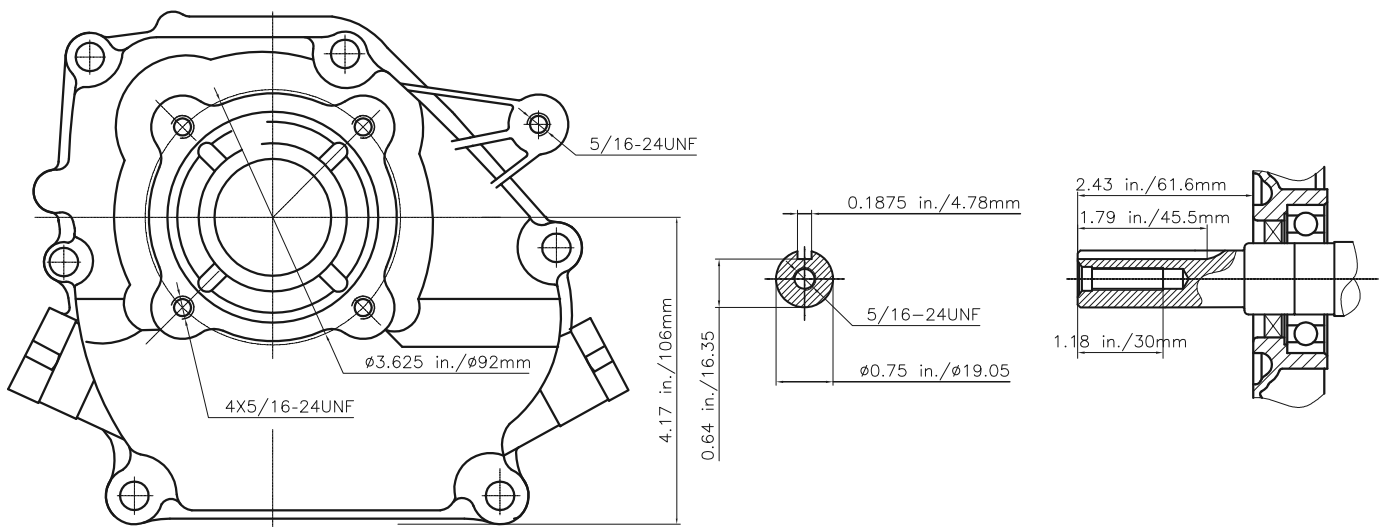

MAINTENANCE

PREDATOR[®]

ENGINES

Limited 90 Day Warranty (Retail)

Harbor Freight Tools Co. makes every effort to assure that its products meet high quality and durability standards, and warrants to the original purchaser that this product is free from defects in materials and workmanship for the period of 90 days from the date of purchase. This warranty does not apply to damage due directly or indirectly, to misuse, abuse, negligence or accidents, repairs or alterations outside our facilities, criminal activity, improper installation, normal wear and tear, or to lack of maintenance. We shall in no event be liable for death, injuries to persons or property, or for incidental, contingent, special or consequential damages arising from the use of our product. Some states do not allow the exclusion or limitation of incidental or consequential damages, so the above limitation of exclusion may not apply to you. THIS WARRANTY IS EXPRESSLY IN LIEU OF ALL OTHER WARRANTIES, EXPRESS OR IMPLIED, INCLUDING THE WARRANTIES OF MERCHANTABILITY AND FITNESS, EXCEPT FOR THE EMISSIONS CONTROL SYSTEM WARRANTY BELOW.

To take advantage of this warranty, the product or part must be returned to us with transportation charges prepaid. Proof of purchase date and an explanation of the complaint must accompany the merchandise. If our inspection verifies the defect, we will either repair or replace the product at our election or we may elect to refund the purchase price if we cannot readily and quickly provide you with a replacement. We will return repaired products at our expense, but if we determine there is no defect, or that the defect resulted from causes not within the scope of our warranty, then you must bear the cost of returning the product.

This warranty gives you specific legal rights and you may also have other rights which vary from state to state.

Emissions Control System Warranty

Harbor Freight Tools (HFT) is pleased to explain the emissions control system warranty on your Small Off-Road Engine produced after January 1, 2015 (engine), in addition to the Retail Warranty above. HFT warrants that the emissions control system on your engine is designed, built, and equipped so that it conforms to the United States Environmental Protection Agency's (EPA) emissions requirements in effect at the time of manufacture. HFT also warrants that the emissions control system on your engine will be free from defects in material and workmanship for two (2) years, provided there has been no improper maintenance, misuse, or abuse of your engine.

Your emissions control system may include parts such as the carburetor or fuel-injection system, and the ignition system. Also included may be hoses, belts, connectors and other emissions-related assemblies.

WHAT WE WILL DO

Where a warrantable condition exists, HFT will repair or replace, at our option, any emissions-related part on your engine if it becomes defective, malfunctions, or otherwise fails to conform with this warranty under normal use and service during the two (2) year term of this warranty at no cost to you, including diagnosis, parts and labor. This warranty applies to the original purchaser and any subsequent owner within the two year warranty period.

WHAT IS COVERED?

The following parts are examples of components of the emissions control system and are covered by this two (2) year warranty. For a full list of emissions control components covered by this warranty, please see 40 CFR §1068, Appendix I.

1. Fuel Metering System
 - a. Carburetor and its internal parts.
 - b. Fuel pump (if so equipped).
 - c. Cold start enrichment system.
2. Air Induction System
 - a. Intake pipe/manifold.
 - b. Air cleaner.
3. Ignition System
 - a. Spark plug.
 - b. Magneto ignition system.
4. Catalyst System (if so equipped)
 - a. Exhaust pipe stud.
 - b. Muffler.
 - c. Catalytic converter (if so equipped).
5. Miscellaneous Items Used in Above Systems
 - a. Vacuum, temperature and time sensitive valves and switches.
 - b. Hoses, belts, connectors, and assemblies.

This warranty does not cover normal maintenance services or replacement of maintenance items such as filters, oils, or spark plugs.

WHAT YOU MUST DO TO OBTAIN WARRANTY SERVICE

As the engine owner, you are responsible for the performance of the required maintenance listed in your Owner's Manual. HFT may deny you warranty coverage if your engine or a part has failed due to abuse (including failure to follow the fuel use instructions contained in this manual), neglect, improper maintenance, or unapproved modifications.

In order to obtain warranty repair or replacement, you may either (a) contact HFT product support at 1-888-866-5797 or predator@harborfreight.com; or (b) bring the to your nearest Harbor Freight Tools retail store. When going to the retail store or contacting product support, you must indicate the specific emissions control part or defect that you are claiming and the date this was originally purchased. The nearest Harbor Freight Tools retail store can be found on the internet at <http://www.harborfreight.com>.

PREDATOR
E N G I N E S

3491 Mission Oaks Blvd. • PO Box 6009 • Camarillo, CA 93011 • 1-888-866-5797