

# NATURALIS 02

DECAGONAL ELONGATED 1.28

**4,34 x 5,96 m**



## ASSEMBLY INSTRUCTIONS GUIDE

A product of  
RP INDUSTRIES



**naturalis**<sup>®</sup>  
P O O L S | by RPI



## CONCRETE SWIMMING POOL, WOOD APPEARANCE

### INTRODUCTION

You have just bought your Naturalis swimming pool. Thank you for your choice and the trust you deposit on our product. We recommend that you read carefully these instructions, follow them step by step, understand the instructions very well and take into account the advice and recommendations transmitted.



**PLEASE READ  
CAREFULLY AND  
KEEP FOR FUTURE  
REFERENCE**



### **IMPORTANT !**

**Before beginning the construction of your pool, read several times this guide. Indeed, the aesthetics and strength of your pool depend on the care with which you will perform the installation. Any problem caused by a mounting and handling, not in accordance with the instructions in this guide could void your warranty.**

All the information inside this guide is true at the moment of publication. However, the photos of the illustrations only serve to show how the process of construction is, they are not contractual, such their color, their shape, their appearance are only examples. To improve its products, RP INDUSTRIES reserves the right to modify at any time and without prior notice, the characteristics, the technical details, the standard equipment and the options of the products.



### **ATTENTION:**

**THE SAFETY OF YOUR CHILDREN DEPENDS ONLY ON YOU!**

**The highest level of risk exists when children are under 5 years of age. The accident does not just happen to other people. Watch carefully and act quickly:**

- The kids' surveillance has to be closed and constant;
- Designate just one responsible for the security;
- Get stronger the supervision when there is a lot of people inside the pool;
- Get wet nape, arms, and legs before getting inside the water;
- Learn lifesaving techniques especially those specifics to children;
- Prohibit diving and jumping into the pool;
- Prohibit running or violent games near the pool;
- Do not permit access to the pool, to children that don't know swimming without life belt or life jacket;
- Don't leave any toys near or inside the pool without surveillance;
- Maintain the water constantly clean and healthy;
- Store water treatment's products out of reach of children.

### **Provide:**

- A lifebuoy and a pole near the pool;
- Accessible phone near the pool so as not to leave children alone when you call;
- If you have an above ground pool, always remove the outside ladder after each use of the pool;
- Furthermore, some equipment can contribute to more safety:
- Safety fence with a gate that must always be kept closed (for instance, a hedge cannot be considered as a safety fence);
- A manual or automatic safety cover, properly installed and fixed;
- Automatic motion or fall detectors, running, and operative;
- However, it does not replace a constant vigilance.

### **If an accident happens:**

- Take the child out of the water as quickly as possible;
- Call immediately the emergency number and follow the given instructions
- Change wet clothes by warm blankets;
- Memorize and fix the emergency numbers near the pool;
- European emergency number: 112

## Safety warnings

It's required to predict a special differential protective device for pools on the electric power of the pump according to legal and technical norms.

The minimum distance between the pump and the pool must be at least 3,50mt, to prevent electrical shock.

Do not leave any child without surveillance near the pool.

After each use remove the exterior ladder, to prevent children or pets from accidentally falling into the pool.

The NATURALIS pool is to be used only for private use.

It's totally prohibited to walk along the edge, dive or jump from the coping.

## Duration of construction

The installation of your pool requires 2 persons and takes about two days (excluding the excavation and the construction of the concrete slab). The concrete slab must be made two weeks before the start of the assembly.

## Before the construction of your NATURALIS pool

Check if:

- The electrical connections of the equipment must be installed by a qualified technician;
- Make sure you have enough water to fully supply and fill the pool;
- The instructions were read with attention and you are able to reproduce the different steps of the installation.

## Implantation Advice

The ground for the implantation of the pool NATURALIS must be prepared according to the instructions of this manual on chapter IMPLANTATION.

DO NOT INSTALL THE POOL:

- Under electrical cables
- Under trees
- On an un-stabilized ground.

A good location for your pool is essential to avoid future problems or disappointments.

The pool must be easily accessible, preferably in a sunny place.

The pool must be installed far from pipes or electrical net.

**NEVER LEAVE THE POOL EMPTY**

# DECAGONAL ELONGATED 4,34 x 5,96 m

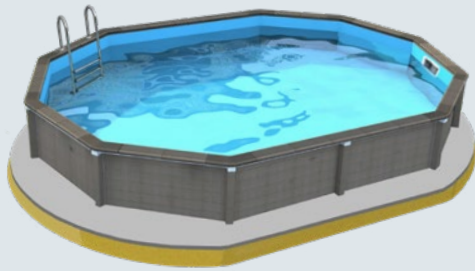

Inside		Outside		Height (m)	Water Volume (m³)	Depth water (m)	Liner	Filtration	Weight (Kg)
Widht (m)	Lenght (m)	Widht (m)	Lenght (m)						
4,34	5,96	5,14	6,76	1,28	23,50	1,10	Solid Liner Bleu Pâle	Cartridge 12 m³/h	2 593 (2 palets)

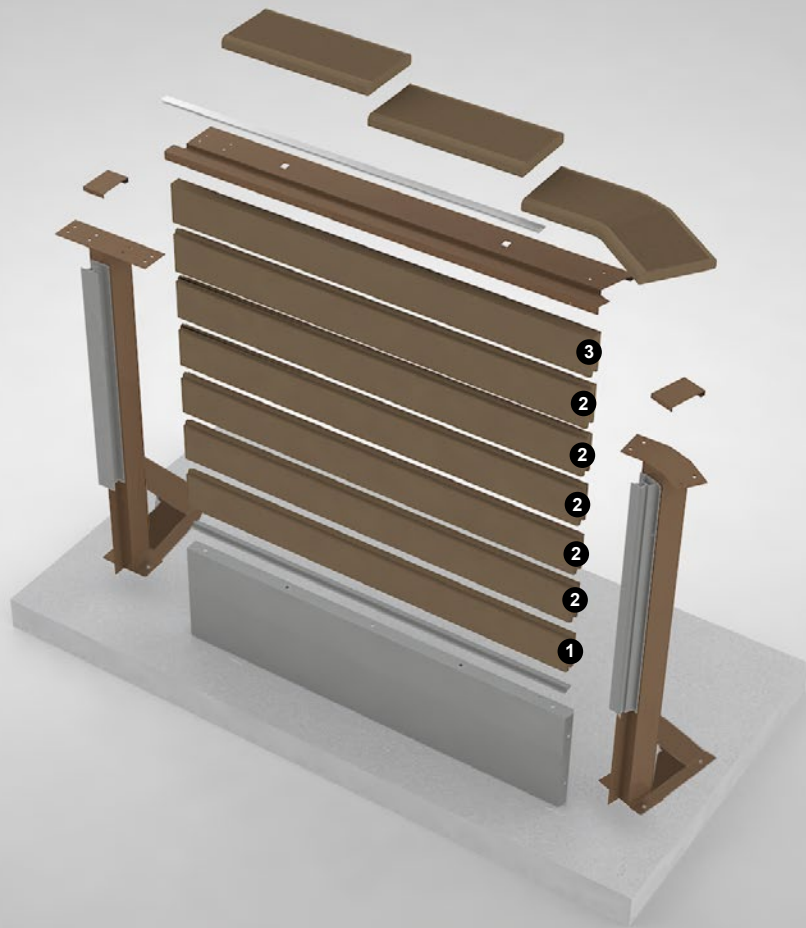

## Necessary tools for Installation:





## Kit composition for Naturalis 02

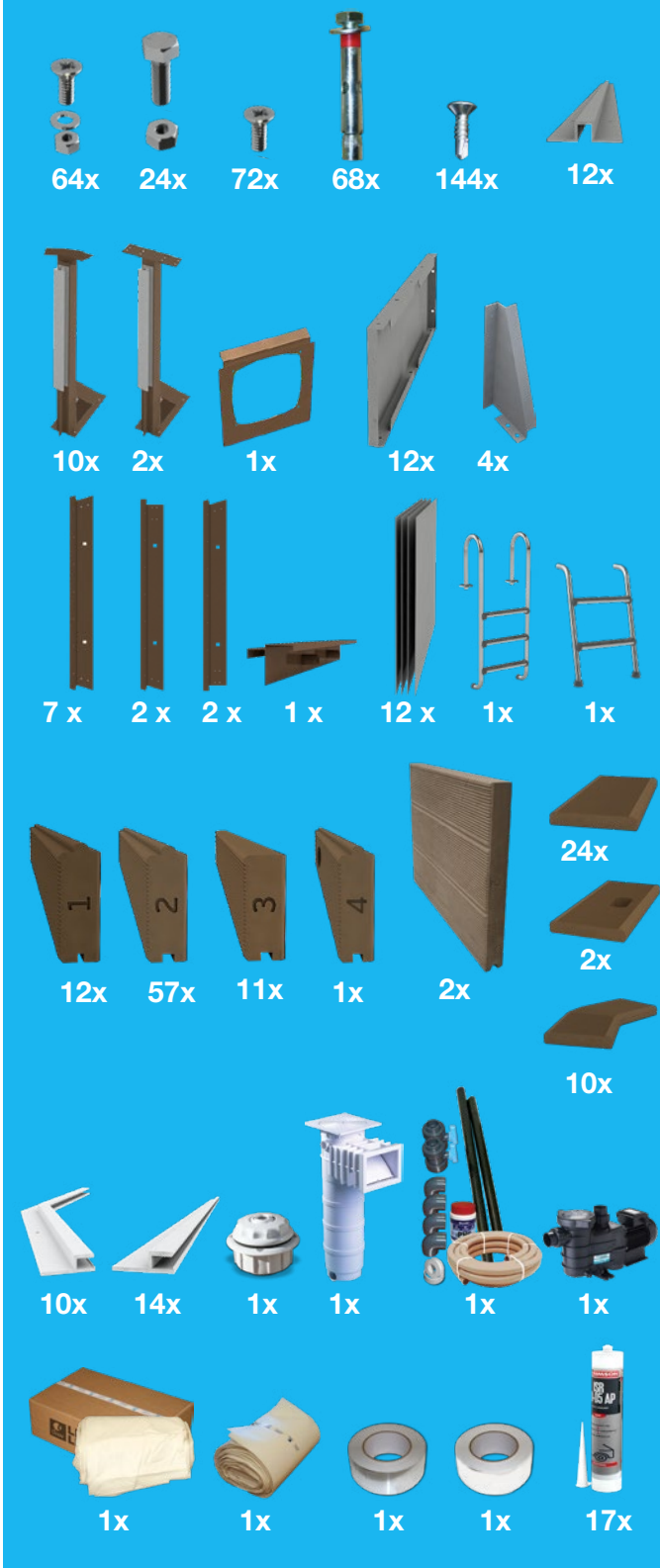

## Presentation of the Naturalis Kit 02



## Ladder



### IMPORTANT:

The ladder can not be used for other purposes.

**Maximum authorized weight: 150 kg**

## SUMMARY

- 1-Implantation
- 2-Excavation work
- 3-Concrete slab
- 4-Marking the layout of the pool
- 5-Fixing of pillars and steel base panel
- 6-Setting up the aluminum profile
- 7-Setting up Beam n°1
- 8-Setting up Beam n°2
- 9-Setting up Beam n° 4
- 10-Setting up Beam n° 3
- 11-Setting up Beam n° 5
- 12-Placing of coping support
- 13-Placing of the HUNG profile
- 14-Fixation of the protective steel panel
- 15-Installation of the embedded parts
- 16- Pump and Hydraulic system connection
- 17-Landfill around the pool
- 18-Installation of the Geotextile carpet
- 19-Placement of the liner
- 20-Placement of sealing rings
- 21-Placing of coping
- 22-Placing of the stainless steel ladder



## IMPORTANT:

Before beginning the installation read these instructions carefully. Any installation, which is not made according to these instructions, will cancel the warranty.

The choice of the pool localization is essential because it affects not only the reliability of the pool but also the comfort of utilization. Take all the time needed for a perfect construction. This way, you will improve the longevity of your swimming pool and the comfort of utilization.

To enjoy your swimming pool, check if it is correctly exposed to the sun. Avoid the proximity of trees and vegetation. Prefer an area without wind.

We recommend the alignment of the pool with an already existing construction (house, wall, terrace...) to fit perfectly in your environment.

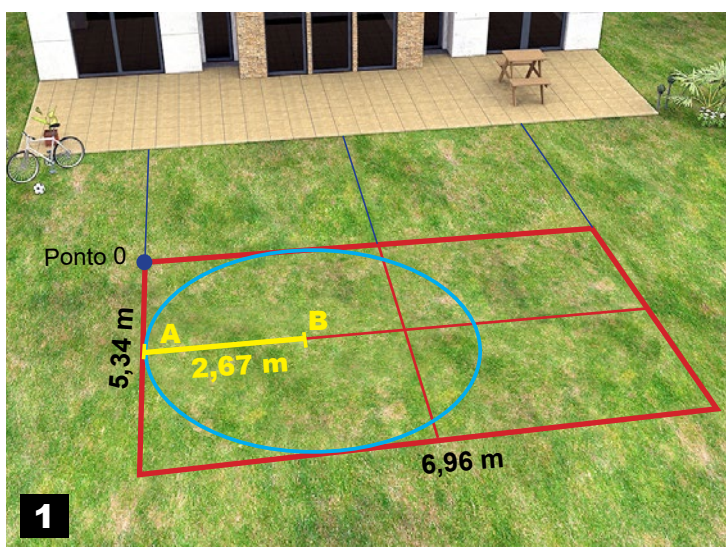

## IMPORTANT:

The structure of your pool must be built on a consolidated field, stable, without landfill with less than 10 years.

The recommendations for partially or totally underground pools are valid for an installation on a dry field, without humidity. The decagonal elongated pool 4,34x5,96m must be necessarily, half-buried to a depth of 42.50 cm.

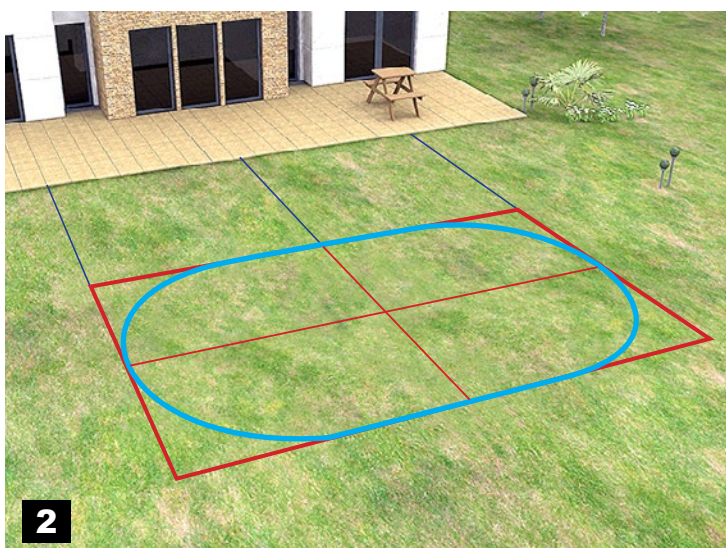

After determination of the location of the swimming pool, fixe the highest point (point zero).

Then, draw on the ground a rectangle 5,34m by 6,96 m.

Plant the stake A from picket B at a distance of 2,67m mts. Draw a circle with a radius of mts.

One all the markings are done, you should obtain an oval shape, such as mentioned in the illustration below.



Begin to evacuate the land inside the circle, 52.50 cm deep according to the highest point.

Once complete, check the level of the ground and put inside the welded metal mesh E300.



3

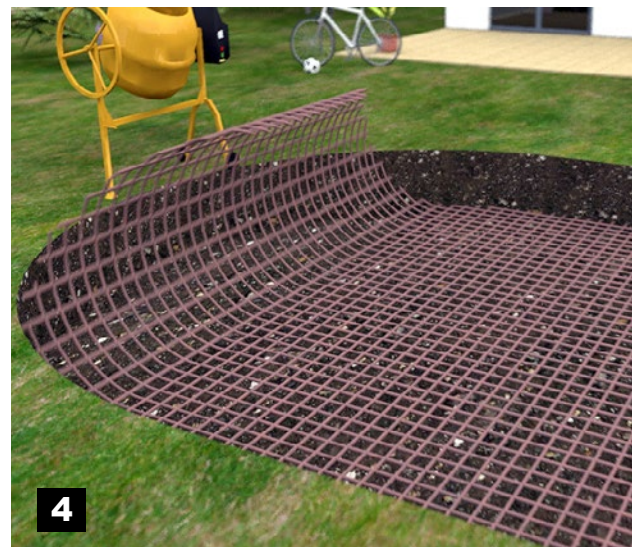

4

### ATTENTION:

The recommendations for partially or totally underground pools are valid for an installation on a dry field, without humidity. The adaptation of these instructions has to be done according to the kind of soil or to the high level of water inside the field (source, water flow, etc) It's highly recommended to place a drainage system under or around the pool to avoid every kind of water stagnation which can damage the concrete work and cause the appearance of spots on the liner.



## Concrete slab

## 3

### IMPERATIVE

The pool has to be built on a concrete leveled slab (only 1 cm is tolerated between the highest and the lowest point of the area of implantation).

Put the welded metal mesh on the soil and make a concrete slab (350 kg) with 10 cm of thickness on all the pool's area. The slab must be smooth, without irregularities and completely leveled.

The concrete dosage is easily obtained by the 1-2-3 rule: To fill the concrete-mixer, put 1 bucket of cement, 2 buckets of sand and 3 buckets of gravel. The quantity of water to add to the moisture depends on the humidity of the aggregates. Anyway, the concrete texture has to be unctuous.

To obtain 1 m<sup>3</sup> of concrete, you have to mix 350 kg of cement, 680 kg of sand and 1175 kg of gravel.



5

**IMPORTANT:**

The assembly of the pool should be performed after complete drying of the concrete slab (2/3 weeks). Dimensions shown are interior dimensions.

Before assembling, proceed to clean the slab to eliminate all kinds of impurities (sand, twigs, leaves, ...). The slab should be smooth without irregularities and properly leveled to allow the correct assembly of the pool.

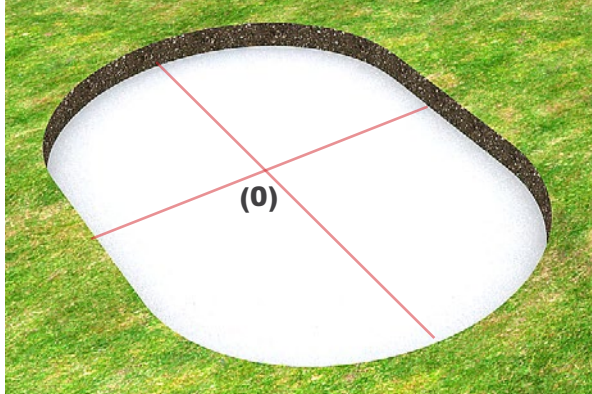

On the concrete slab perform marking the route of the pool. A first marking finds the center point of the concrete slab (0).

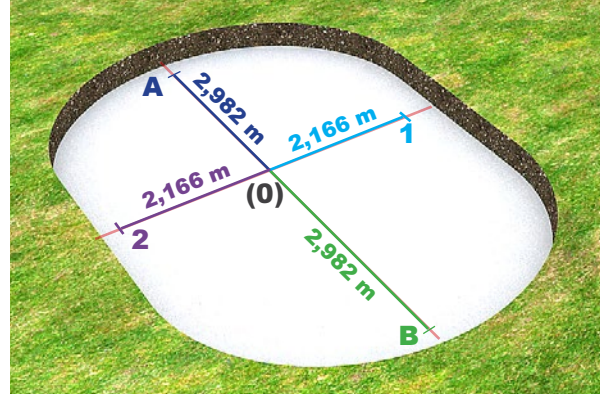

Perform marking of points **A** and **B** separated 2,982m from the center of the pool (0). Repeat to get points 1 and 2 with a distance of 2,166m from the center of the pool (0).

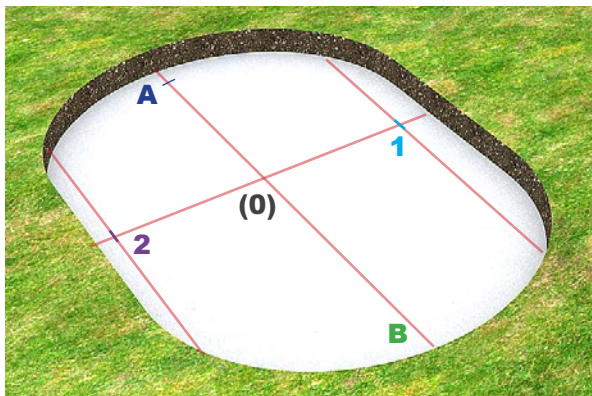

From points **1** and **2** draw two parallel lines the **A / B** over the entire length of the concrete slab.

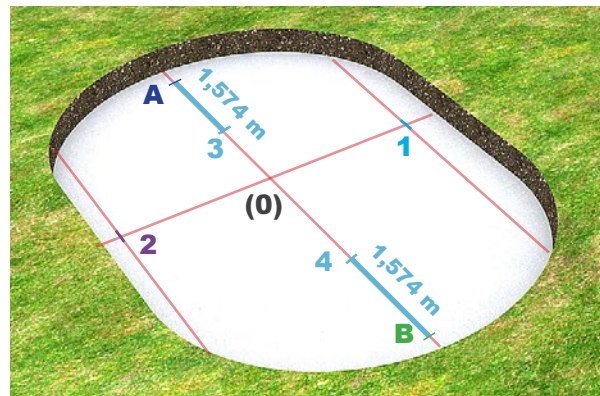

Perform marking of points **3** and **4** distanced 1,574m from points **A** and **B** respectively.

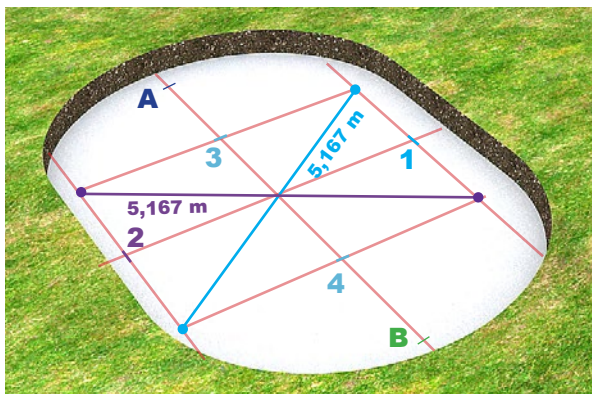

From the points **3** and **4** draw two parallel lines about **1/2** the entire width of the concrete slab. Then confirm with the corresponding diagonal measurement 5,167 m.

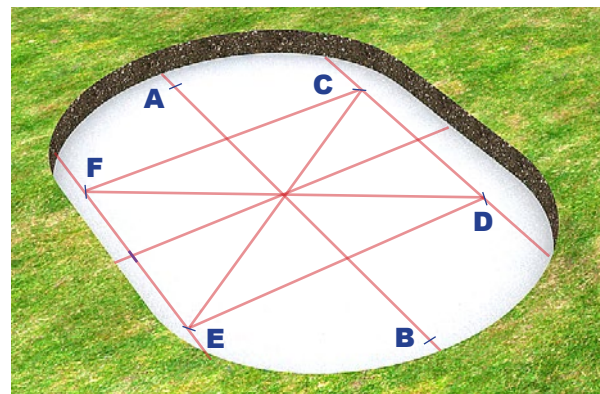

With these points, you will obtain the location for the first pillars.



**NOTE:**

There are two types of pillars: straight and angle. The right pillars are placed on the length of the pool. The angle pillars are intended to be placed across the width of the pool.

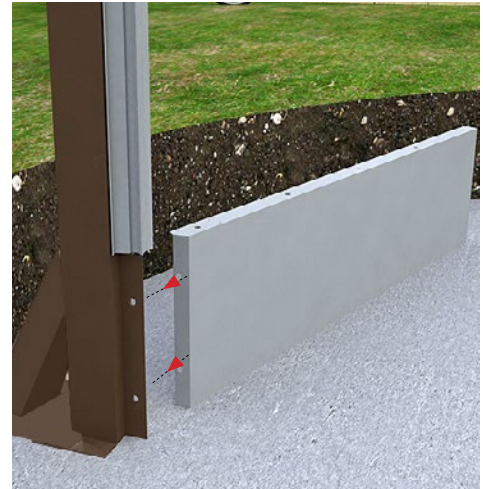
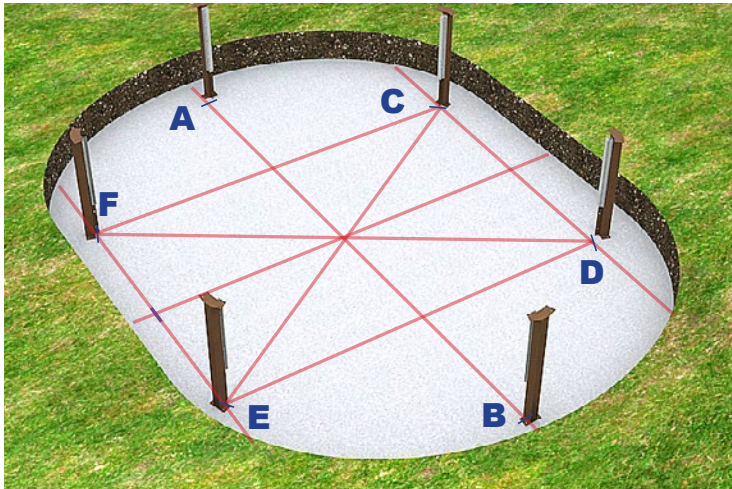

To obtain the position of the remaining pillars, install the base structure panels.

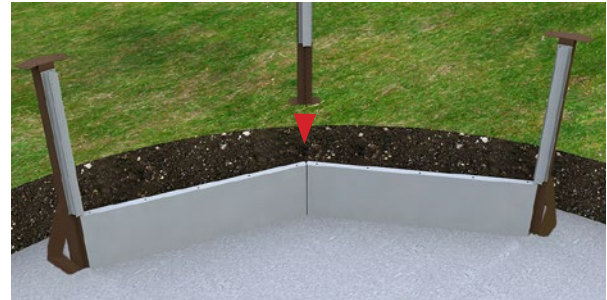

Install the two panels between the **A** and **C** pillars for the location of the intermediate pillar. Do the same for the location of intermediate pillars between **D/B**, **B/E** and **F/A**.



Fasten two screws in the pre-defined drilling and proceed to the union of the pillars to the base structure.



For the location of the column intermediate between **C/D** and **E/F** put the two basic structure panels.



Repeat to get the shape of the pool. The plant on the next page defines the location of the respective pillars.

**ATTENTION:**

Before proceeding to the final establishment of the pillars to the concrete slab must verify the dimensions and the leveling of the structure as indicated.

Points A, B, C, D, E and F define the location of the first angle pillars.

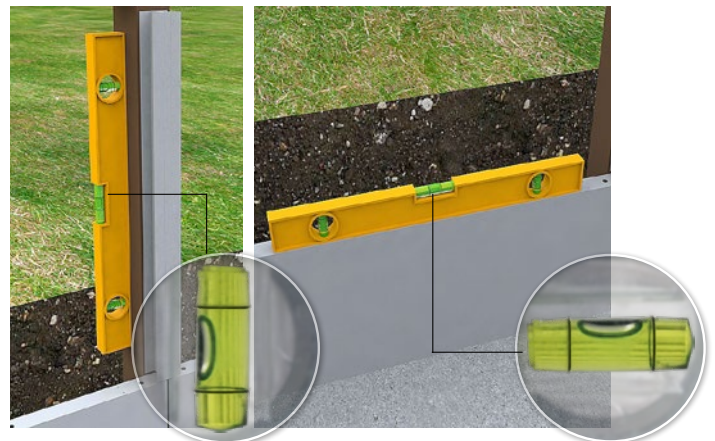
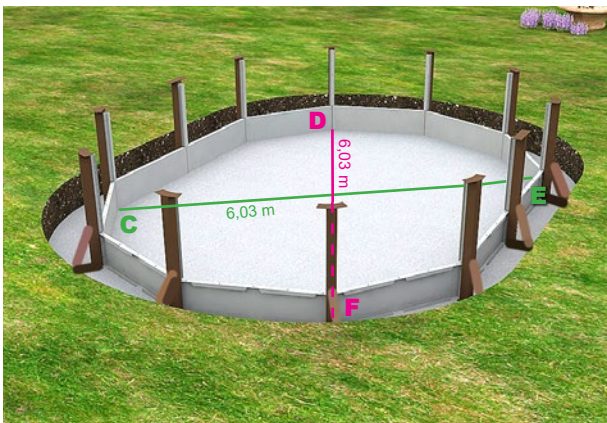
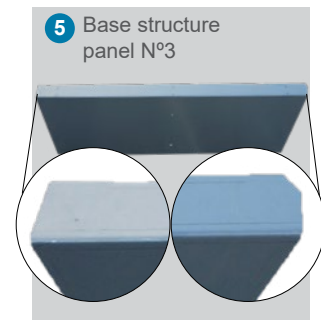
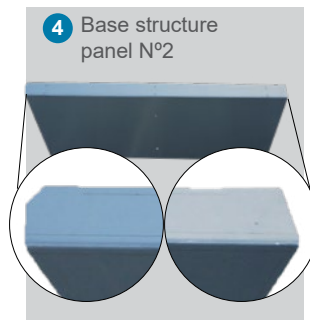
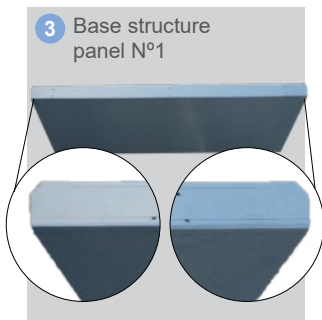
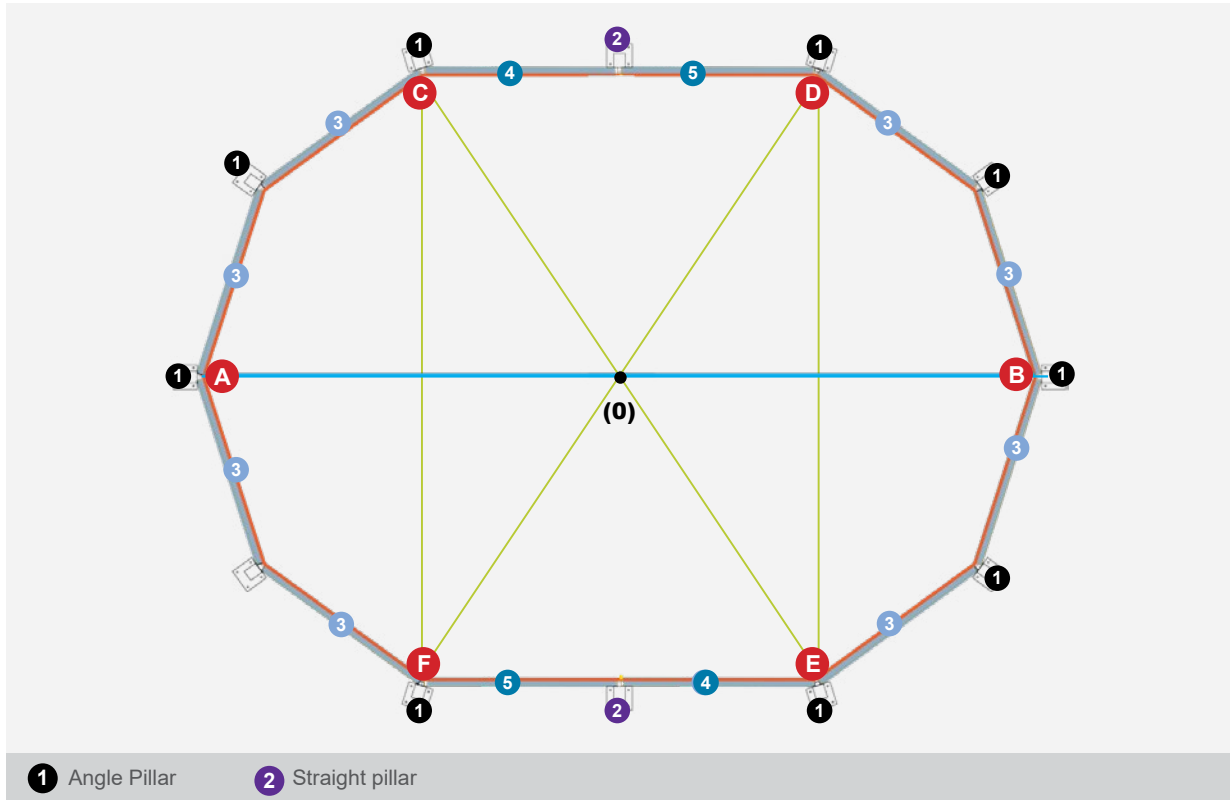

After performing the positioning of the pillars and the base structure, as indicated in the plant confirm the dimensions of the diagonals. The distance between **C / E** and **D / F** should be 6,03 m.

Before proceeding to the fixing of the pillars and the base structure to the concrete slab ensure that the pillars are properly upright and the structural panels are leveled.



## Fixation of the pillars

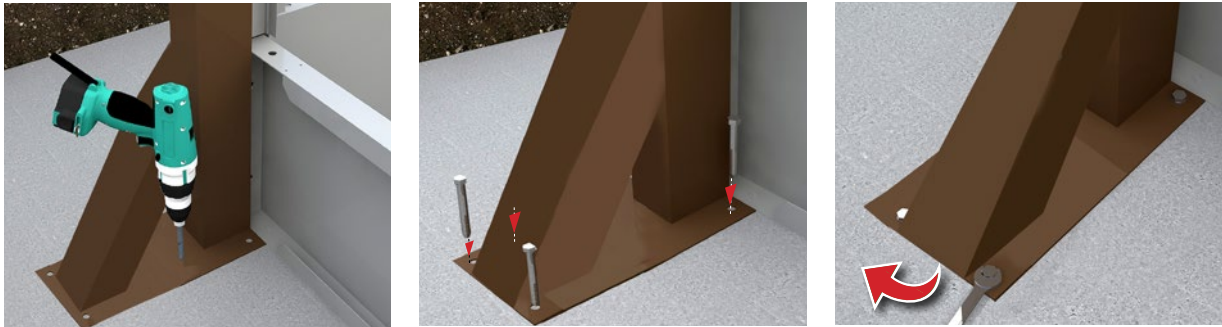

Drill concrete with a drill, using the existing hole in the base of the pillar. Repeat for the structure. Then secure the pillar to the slab using the steel anchors provided in the kit.

## Fixing the base structure

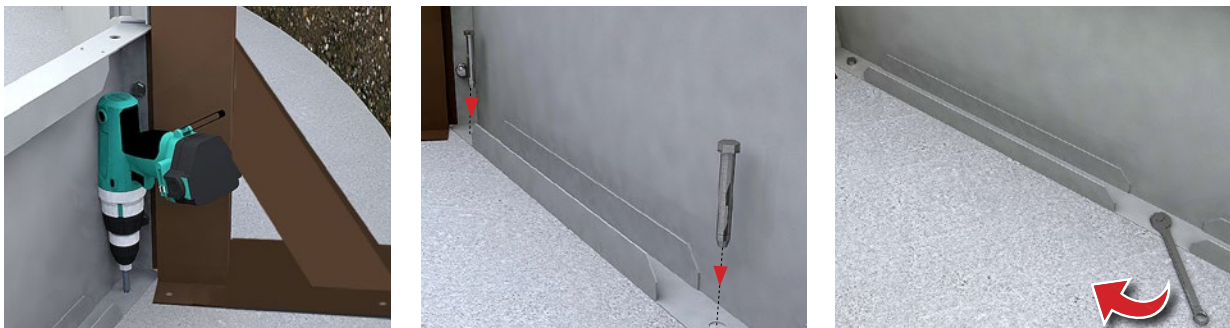

Using the same method of fixing pillars, make the fixing of panels of the base structure.



### ATTENTION:

Should screw all pillars making sure they are leveled and upright.

## Fixing of triangular reinforcements

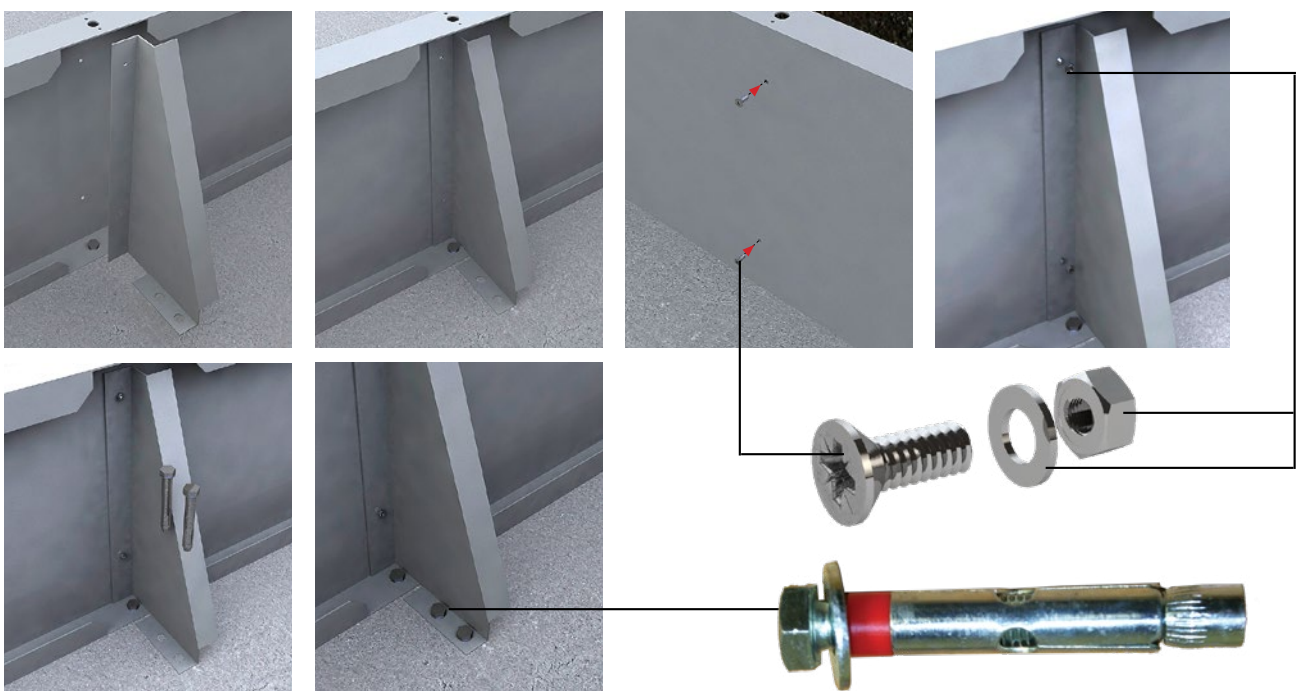

Position the triangular reinforcement on the panel, fixing by the existing holes. Use the respective bolts and nuts for fixing the panel. In fixing the triangular reinforcement use metal bushings used when fixing the structure base panel.



# 6 Placement and fixing of aluminum profile



## IMPORTANT:

Before the placement of the aluminum profile, you should apply a bead of silicone to the top of the base frame panel. You should previously clean both pieces.

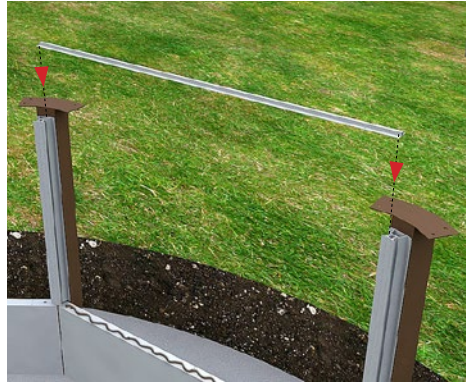

Developed to allow the fitting of the first row of platters of the wall the aluminum profile rests on top of the base structure panels. Slide the aluminum profile in the recess of the post to the top of the panel.

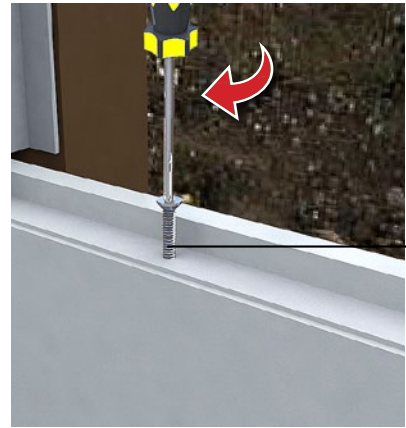

After positioning the aluminum profile in the base structure panel will be noticeable that the drilling from the profile is aligned with the existing hole in the top of the panel.

Use these holes to attach the profile to the base frame using the screws provided in the kit.



Proceed to the set of profiles using all the holes for the purpose. Repeat around the perimeter of the pool.







## ATTENTION:

For the placing of the beams, it is mandatory to respect the numbering of the parts. The platters are numbered as shown in the photo.

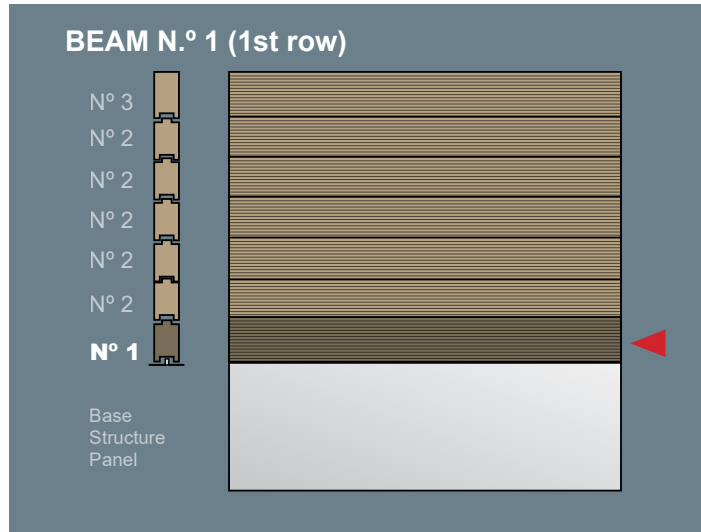

## IMPORTANT:

Prior to the laying of the first row of beams, you must clean up the aluminum profile and apply a bead of silicone on top and inside of the profile.

The silicone supplied in the kit will help you fix the beams, putting them evenly and to confer greater resistance to the wall.



The beam, which will form the first row is n.º 1 and fits directly on the aluminum profile, previously covered by a silicone bead.





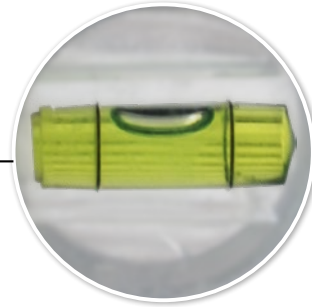
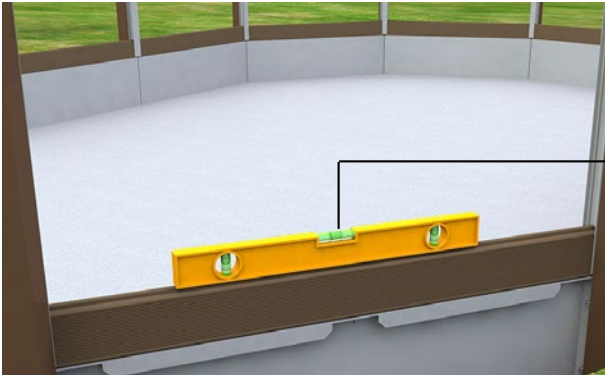
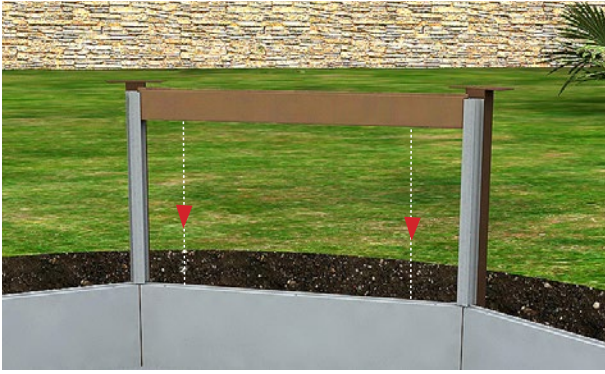

During the placement of the beam, ensure that this is perfectly leveled.

Place the first row of beams, formed by beam n.º 1, around the perimeter of the pool.



Once placed the first row of beams check that they are correctly fitted so that it can ensure a perfect assembly of the rest of the structure.





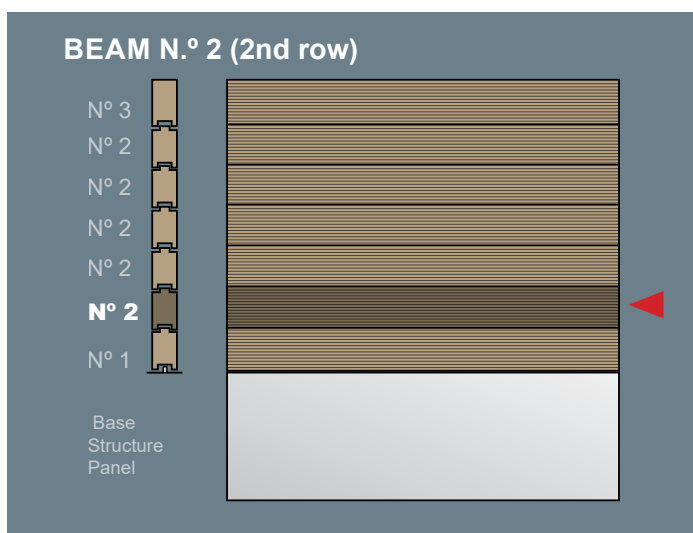

**ATTENTION:**  
Before placing the sleepers, apply a silicone cord, as indicated for the first row (on the top of the sleepers).  
  
The crossbeams must be fitted without any particular effort and always at level.

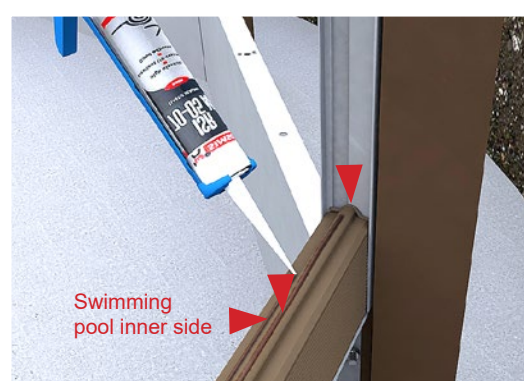

Numbered in the part itself (n.º 2), the 2nd row of beams fit on top of the beams n.º 1







### IMPORTANT:

You must apply among each slat a bead of silicon in the whole length in order to fix and secure a perfect stability of the whole structure.

At each end, you must also apply a dot of silicon between the beam and the aluminum profile.

### CAUTION:

A defective fixation may cause cracks in the beams, thus is not covered by the warranty.

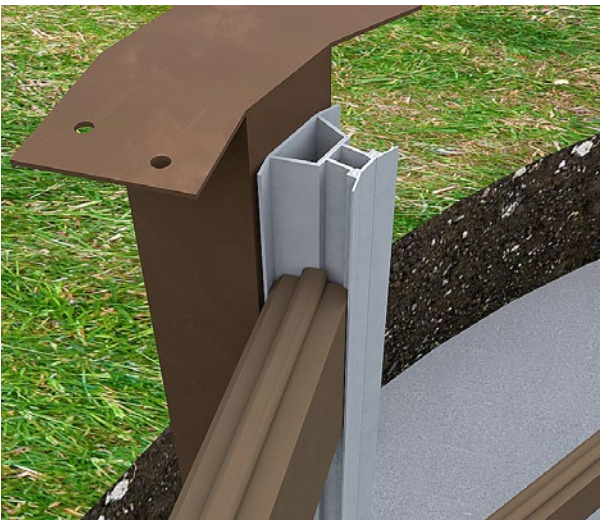

The 2nd row of beams is installed all around the perimeter of the pool. Such as the previous row you must verify that all the beams are correctly fitted and leveled.



Once the 2nd row is installed, proceed to the placement of the following rows.



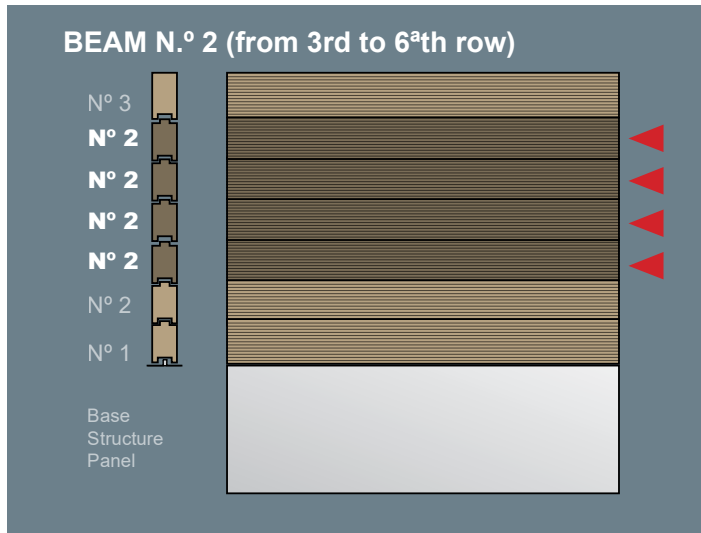

The beam n.º 2 is intended to build the wall of the pool from the 2nd to the 6th row. The next chapter will deal with the placement of the panel where the outlet nozzle and the skimfilter will be inserted.



Placement of platter n.º 2 to row n.º 6.



## IMPORTANT:

In each row, you should be equipped with a spatula, remove excess of silicon in between the beams, as shown in the photograph.



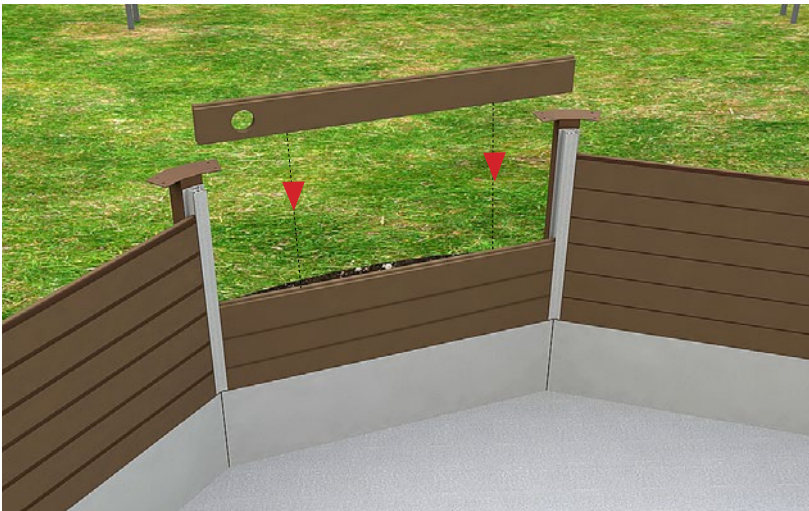
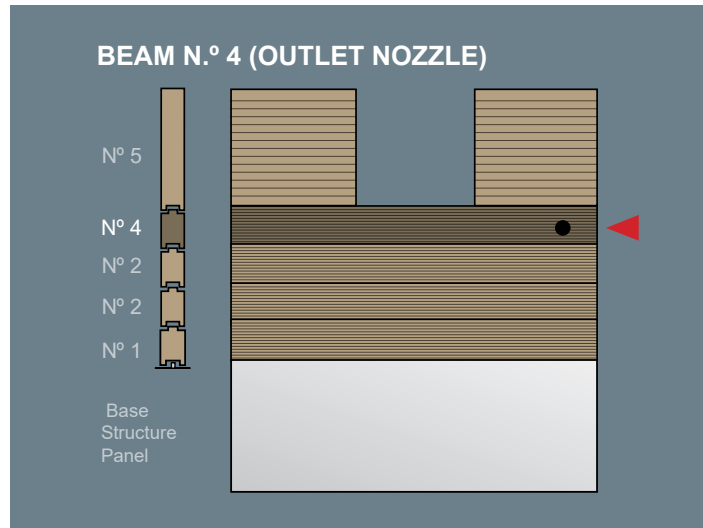

The beam n.º 4 is for fixing the outlet nozzle (and, optionally, the projector) it should be in the 4th row.

The n.º 4 beam should be placed just below the future location of Skimfilitre.



### ATTENTION:

In case of installing a projector, you must place the beam in desired location on the 3th row.





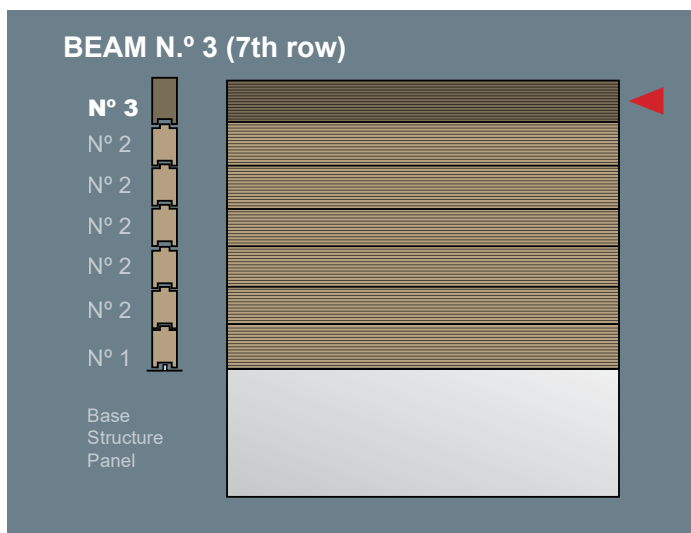

The beams n.º 3 are intended to be placed in the last row of the pool wall (except for the skimmer wall).

The beams are fitted and fixed in the same way as the previous rows

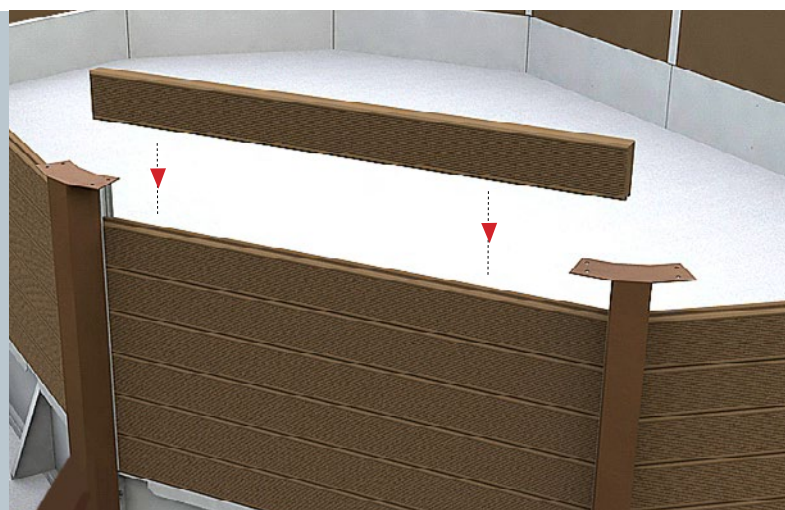

**IMPORTANT:**  
 As in previous rows, it must be applied before placing beam n.º 3, a bead of silicon through the whole length in order to fix and secure a perfect stability of the whole structure.  
 At each end, you must also apply a dot of silicone between the plate and the aluminum profile.



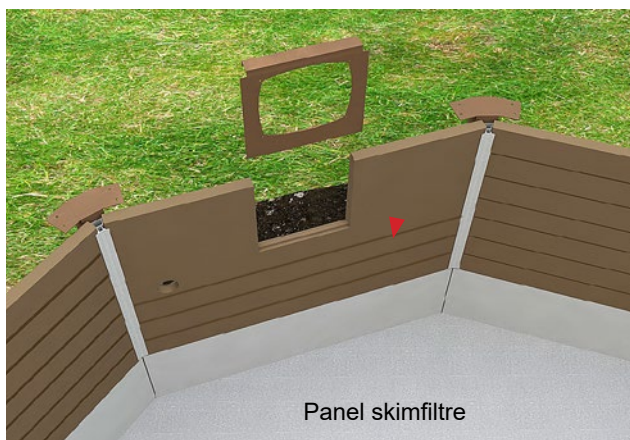
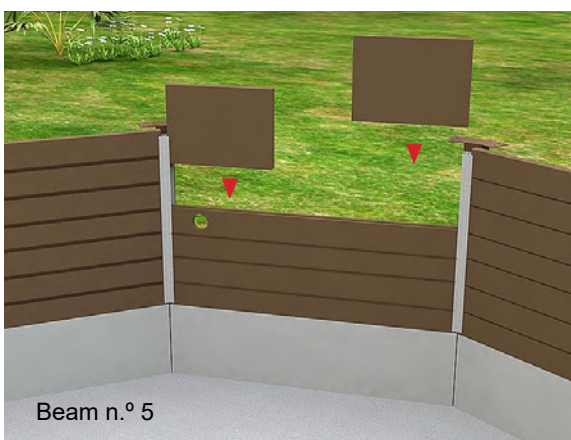
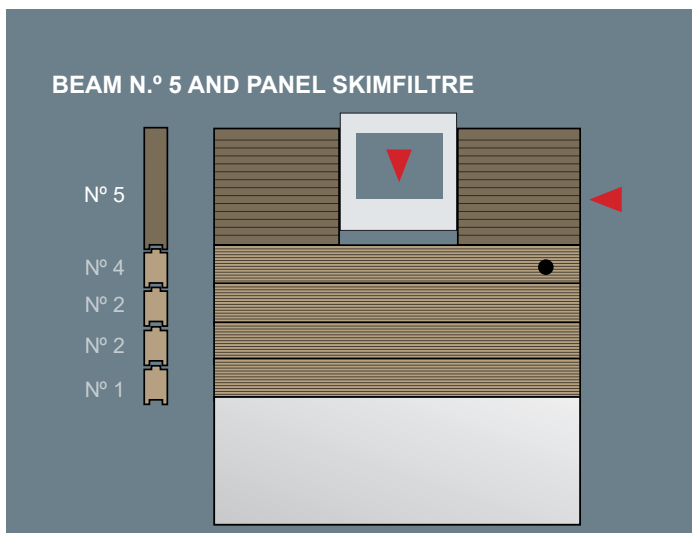

The two beams are placed on each side of skimfiltre, occupying the space of the 5th to the 7th row and are identified with n.° 5. Between the two beams, it is placed a steel panel for fixing the skimfiltre.

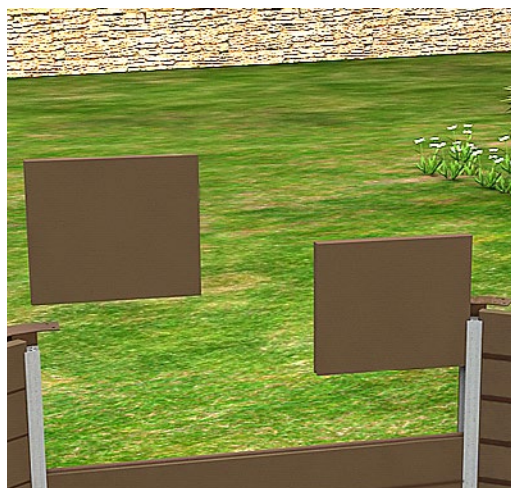

Placement of beam n.° 5

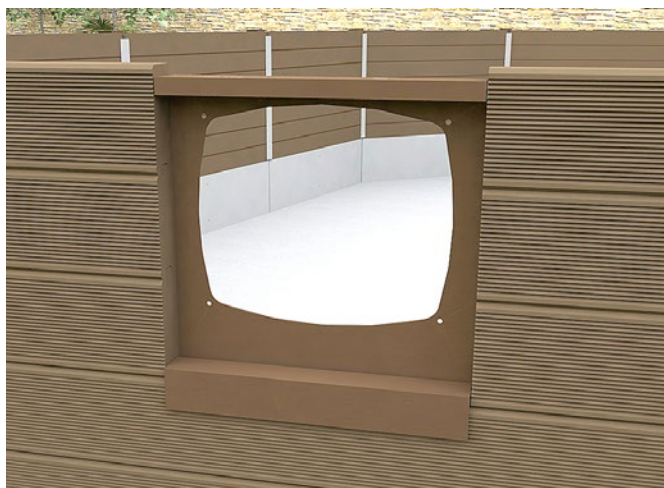

Placement of Panel skimfiltre



### IMPORTANT:

After placing the Skimfiltre steel panel, approximate beams n.° 5, as shown in the photograph





**NOTE:**

There are two types of coping supports: the straight and the angle. The straight are placed on the length of the pool. The angle is designed to be placed on the width of the pool.

The steel supports are fixed with the nuts and bolts supplied in the kit (using appropriate tools).

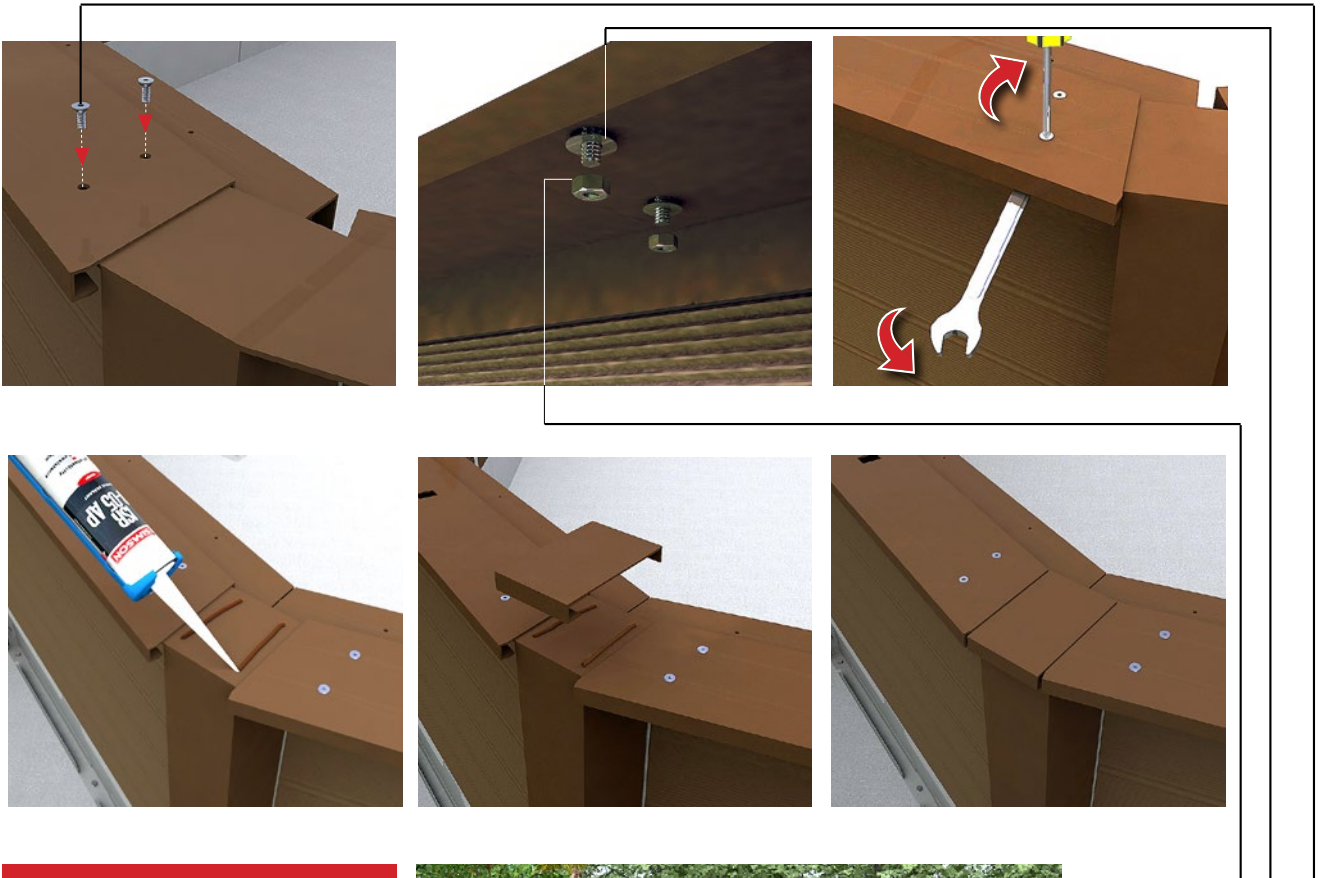

**IMPORTANT:**

Decide the location of the stairs for the fixation of holders.

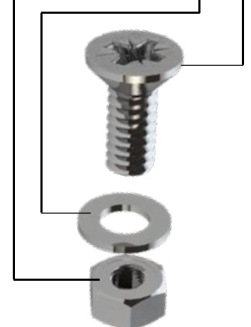



# 13

## Placement of PVC HUNG profile for liner

At this stage, you will have place the PVC liner profile, as shown in the figures.

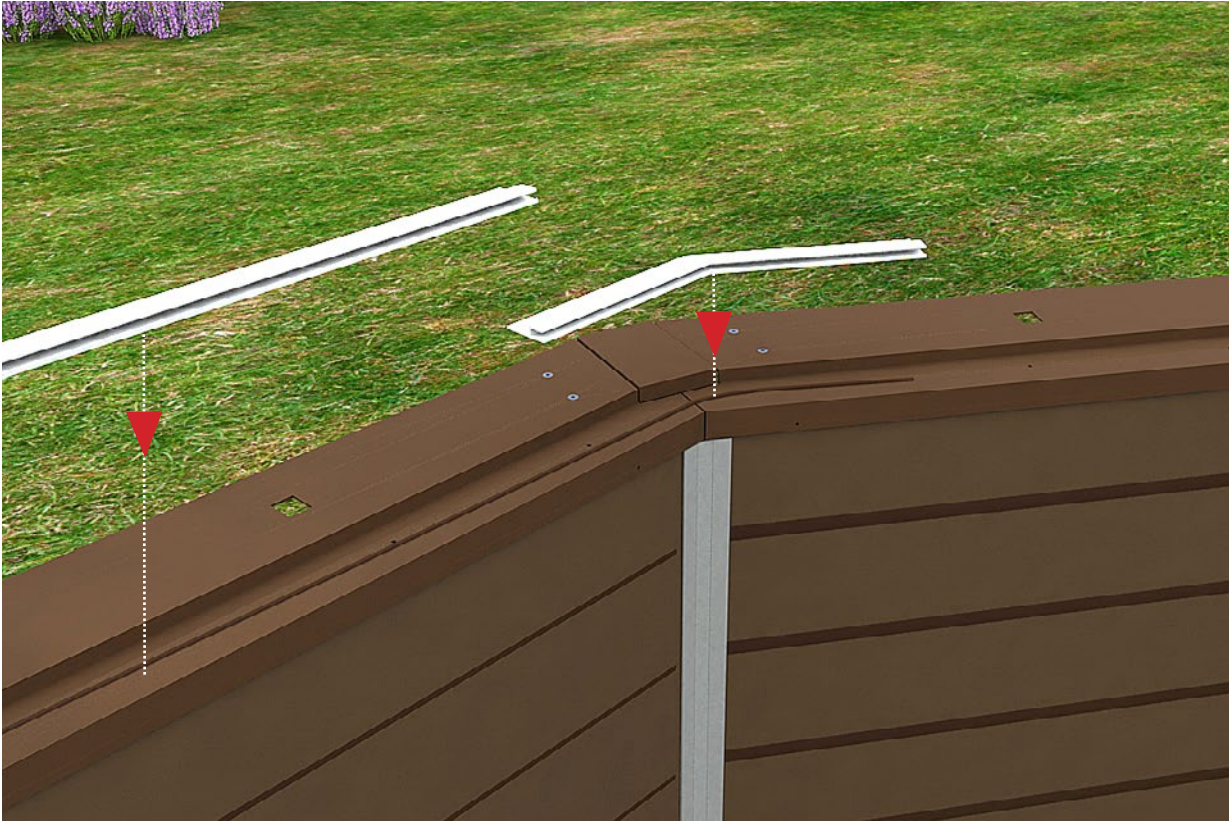

Start by applying a bead of silicon on the coping metal support on the inside edge of the pool. Using a drill machine and a steel drill of 3,5mm, make a hole every 20 cm, then put a bead of silicone and finally fix definitively the profile to the metallic support with the adequate screws.

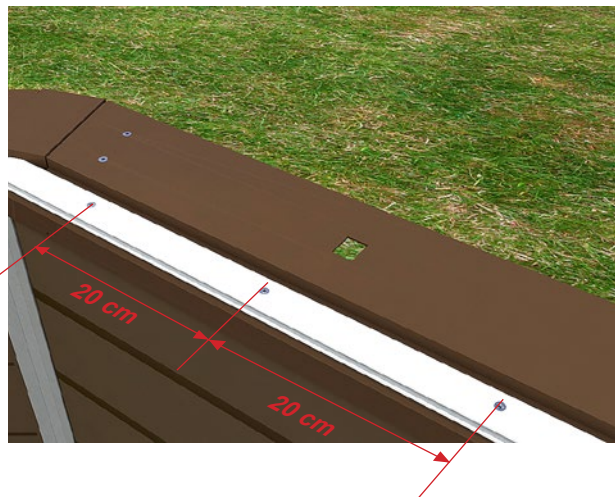
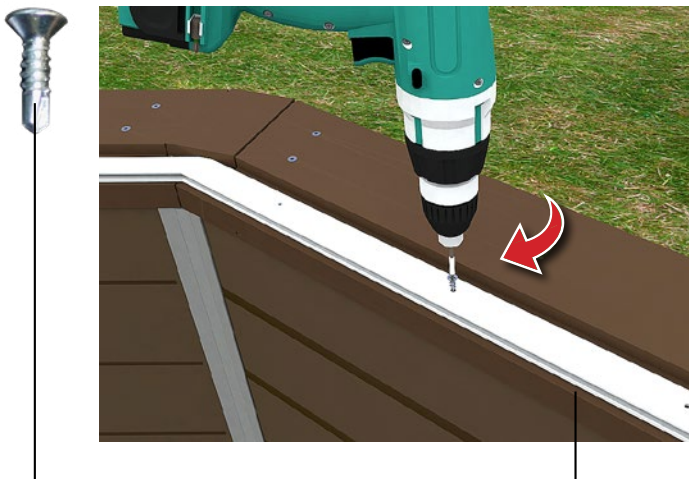
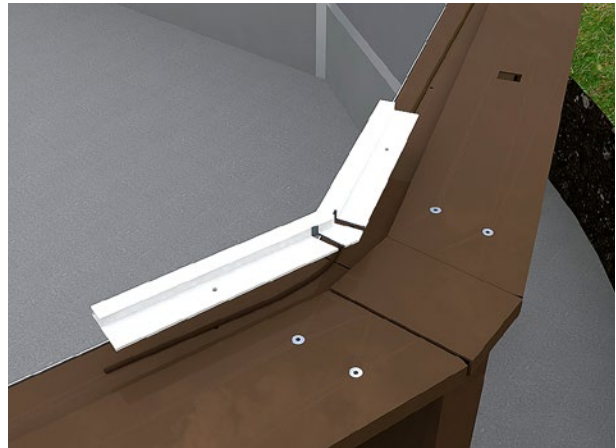
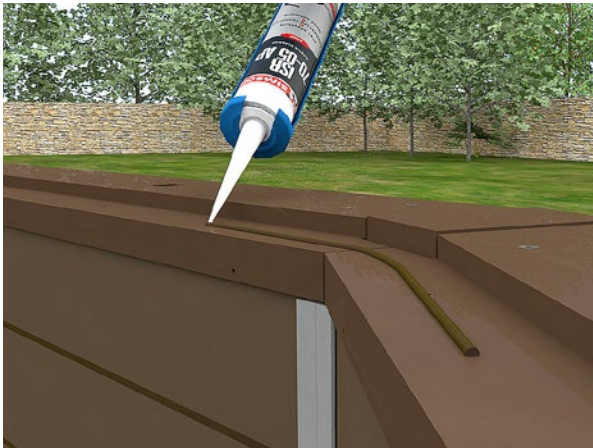





The fixation of the steel panel is initiated by the skimmer wall. Place two steel panels making their sides overlap by approximately 1.5 cm. Apply the self-tapping screws at 3 points in the middle of the pillar, as shown in the photograph, and screw the panels.

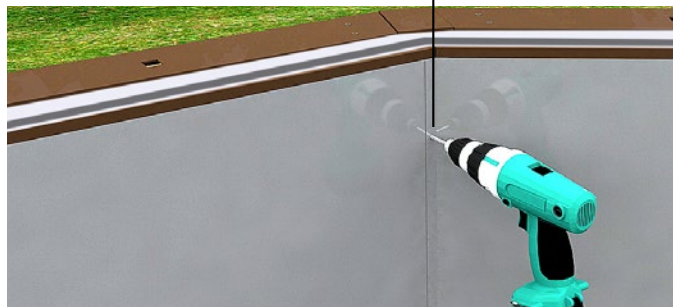
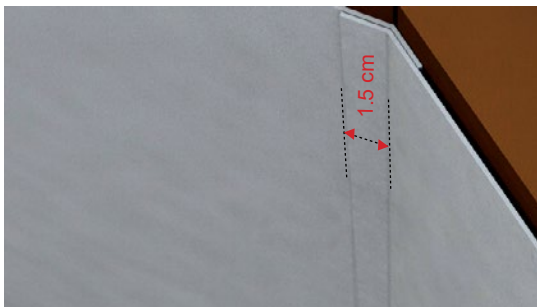

Repeat this process for all panels.



## IMPORTANT:

Check and make sure that the steel panels are straight and perfectly fixed on the pillars.



### Placing the aluminum tape

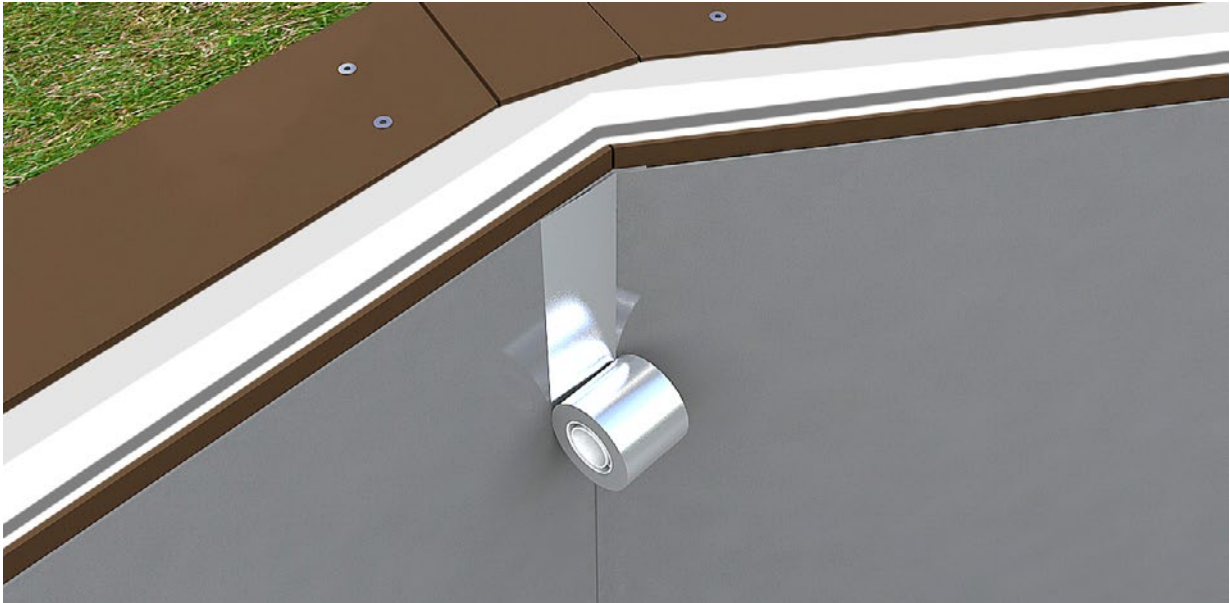

Once you have screwed all steel panels, apply the aluminum adhesive tape to hide the screw head **(1)**.

Apply aluminum tape between the steel panels and coping metal support parts **(2)**, also on the junction of the steel panels and the base structure panels **(3)**.



Use the same procedure to put aluminum tape on the joints of the accessories panel **(4)**.

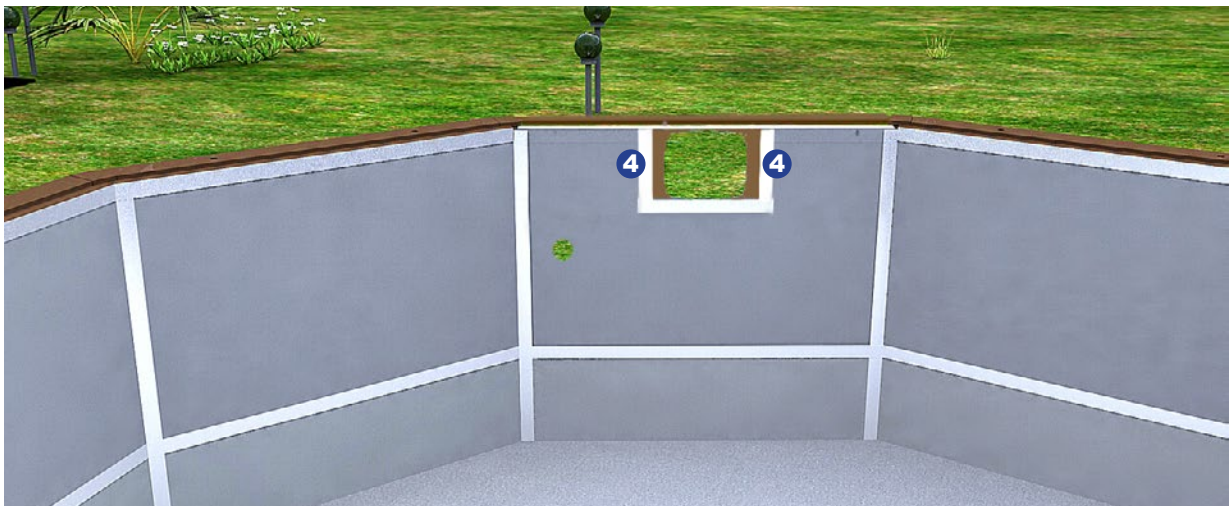



## Placement of the skimfilitre

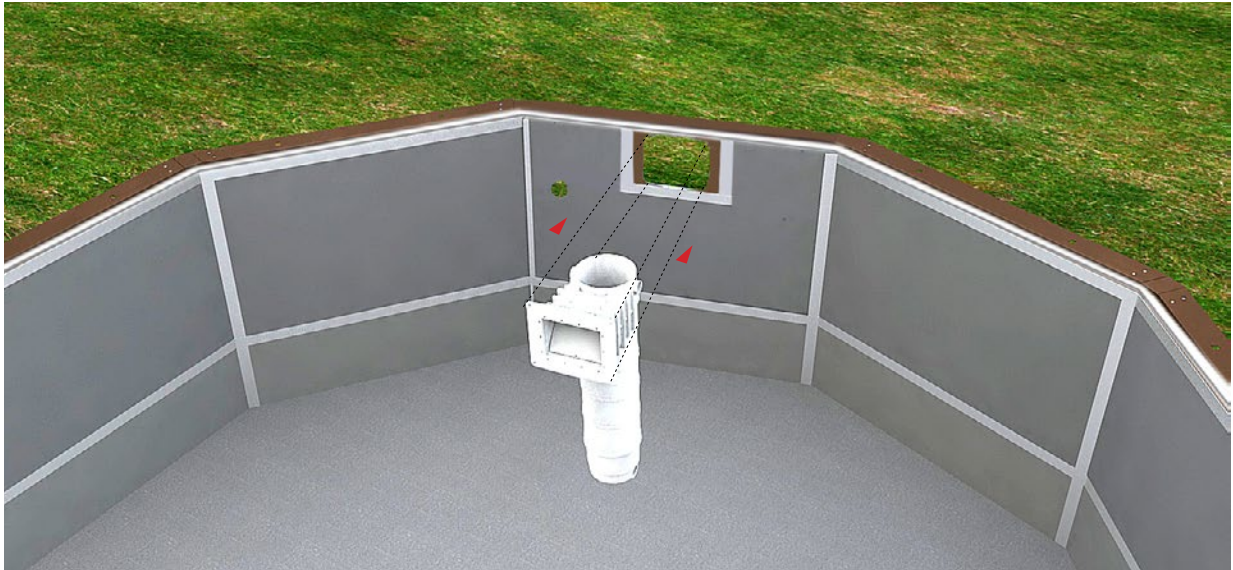

The Skimfilitre is installed on the metal panel cut out for that purpose.

In order to facilitate transport and placement, Skimfilitre is presented in two parts.

The bottom part n.º 2 is placed after the attachment of the upper wall n.º 1.

To fit the two parts put glue provided with SKIMFILTRE on part n.º 1 and part n.º 2, as shown in the photograph.

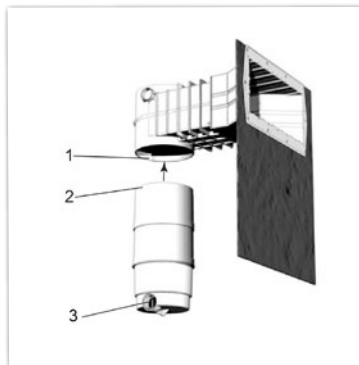
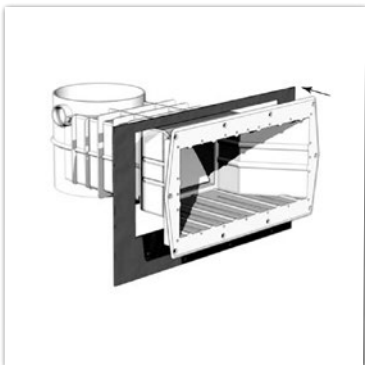

### ATTENTION:

When applying the two parts of the Skimfilitre, make sure that the glue is properly implemented and that the n.º 3 output is directed to the filtration pump.

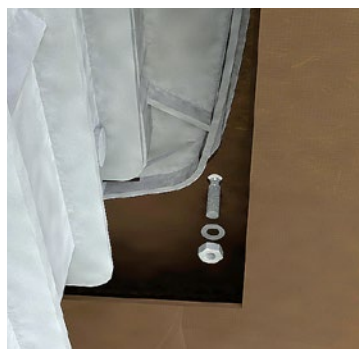
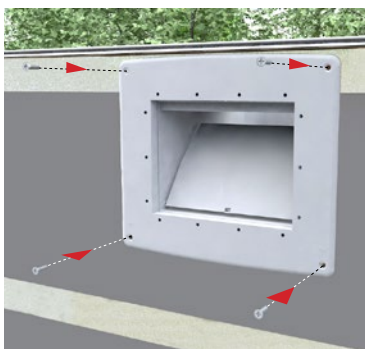
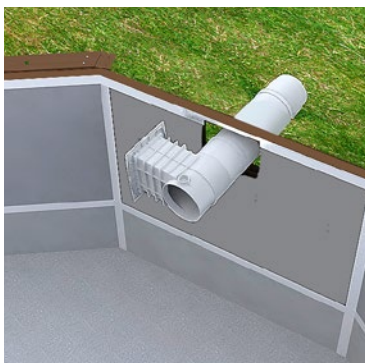

Following the correct placement of the Skimfilitre on the steel panel, it is fixed with the screws provided, taking into account existing perforations, as shown in the images.

### Placement of the outlet nozzle

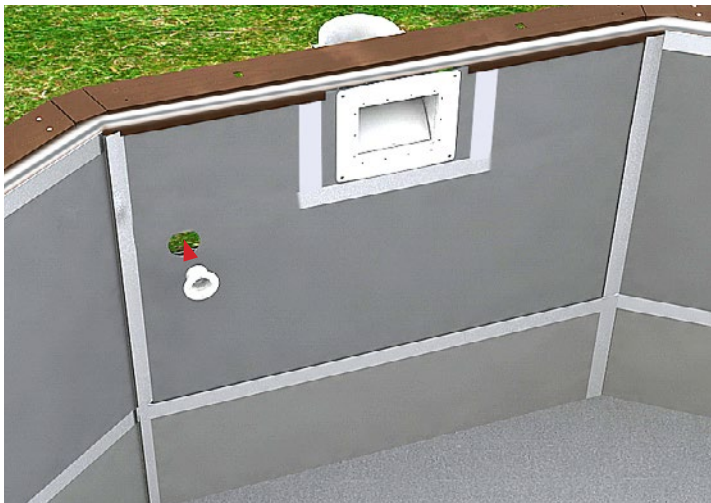

The outlet nozzle is placed in the hole conceived for this purpose.

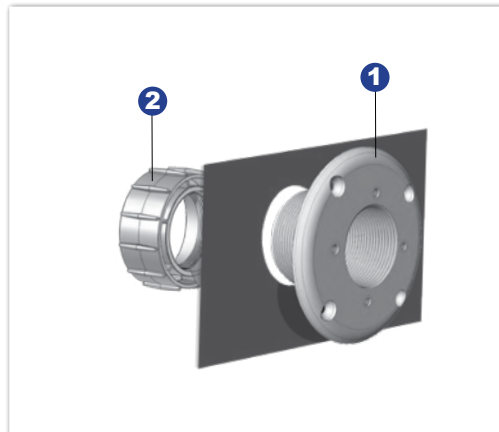

The outlet nozzle is placed on the inside of the pool and with its screwed side facing the outside (1).

By the external side, tighten the nut (2).

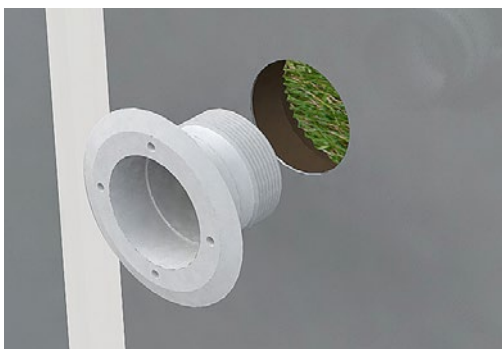

### ATTENTION :

If your pool was delivered with a projector as an option, proceed to install using the same method used for the placement of the outlet nozzle.

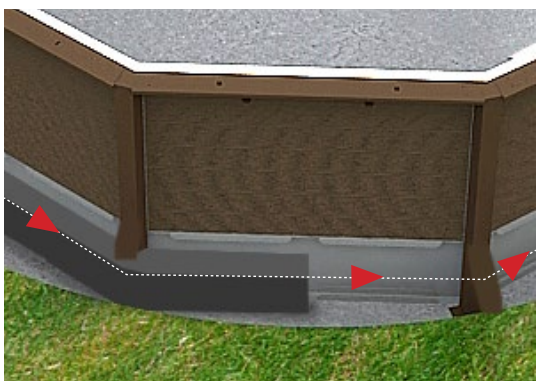

### IMPORTANT:

It is imperative the realization of a belt of concrete of 20 cm of height and 35 cm of width, in order to strengthen the structure of the swimming pool Naturalis.







## IMPORTANTE:

It is essential that the filtering system is in conformity to standard C 15-100, which requires that all electrical equipment located less than 3.5 m of the pool must be supplied with low voltage: 12V and all electrically powered device 220V must be located more than 3.5 m from the pool or indoors.

The auto- aspirant pump must not be installed above the water level.

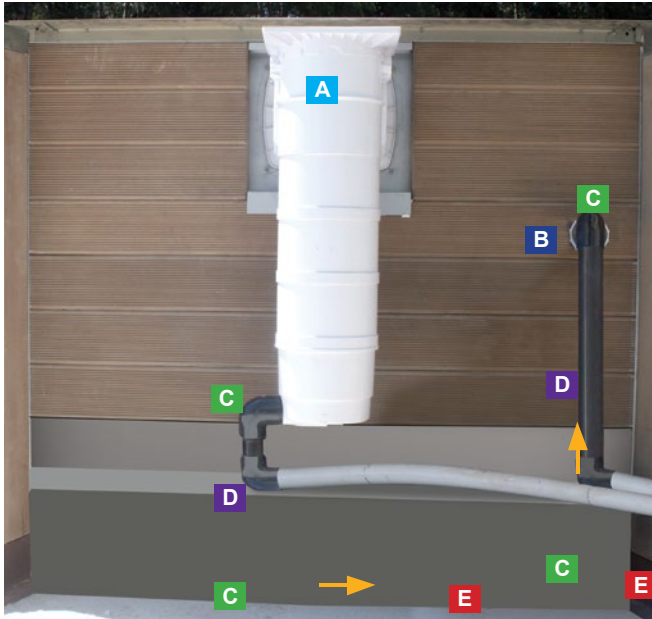

## PUMP AND HYDRAULIC SYSTEM CONNECTION

- A** Skimfiltre
- B** Outlet Nozzle
- C** Elbow 90°
- D** PVC pipe
- E** Flexible PVC hose
- Way of water circulation

## CONNECTION OF SKIMFILTER TO THE PUMP

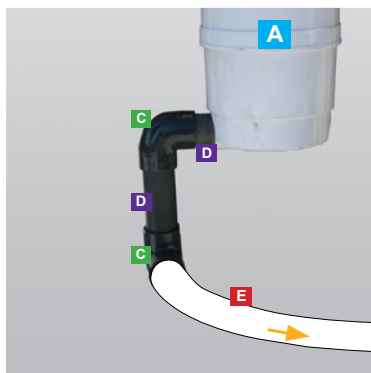
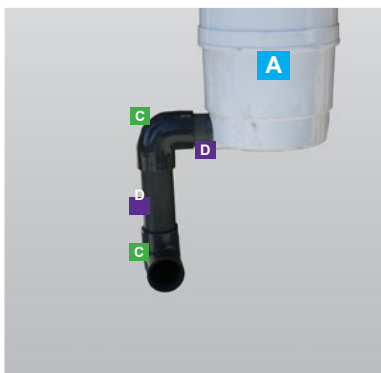

To connect the skimfilter, cut about 7 cm of PVC pipe and connect the skimfilter exit to the elbow 90°. Then, cut enough PVC tube to reach the ground.

Clean both accessories with a cloth, apply the PVC glue on the accessories in order to unite, as shown in the photograph.

According to the draft, glue an elbow 90° and connect it to the flexible hose that will be linked to the pump.

## CONNECTION OF THE OUTLET NOZZLE TO THE PUMP

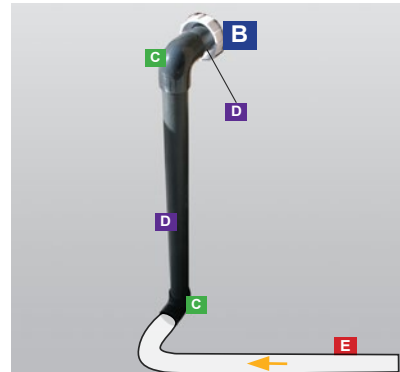

Follow the same indications as for the Skimfiltre.

## CONNECTION OF THE PUMP



### ATTENTION:

The pump should be located more than 3.5 m from the pool or in an enclosed area.



After having made the connection of all accessories to the pump, refer to professional service to make the electrical connections.





Then perform the landfill until the steel base frame is completely covered (approx. 42.50 cm).





# 18 Installation of the Geotextile carpet



Proceed to the placement of the different parts and perform the necessary cuts in geotextile carpet to obtain the shape and dimension corresponding to the pool.



## **IMPORTANT:**

Clean the bottom of the pool before proceeding to place the carpet.

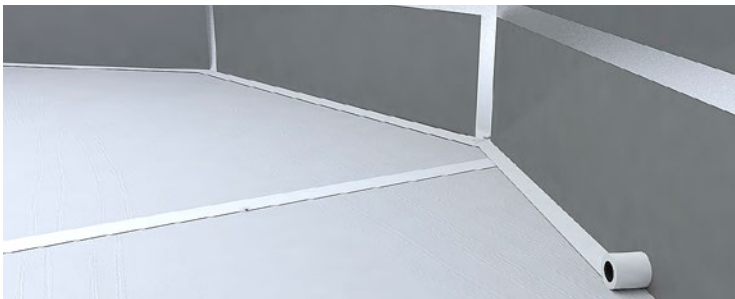

Afterward, put the different pieces, properly tensioned at the bottom of the pool without making it overlap, and finish with the application of tape over the joints of the different elements. Also, apply the tape around the pool on the geotextile carpet and steel wall.







**ATTENTION:**

Prior to installing the liner, you must put the joints of the Skimfiltre and outlet nozzle.

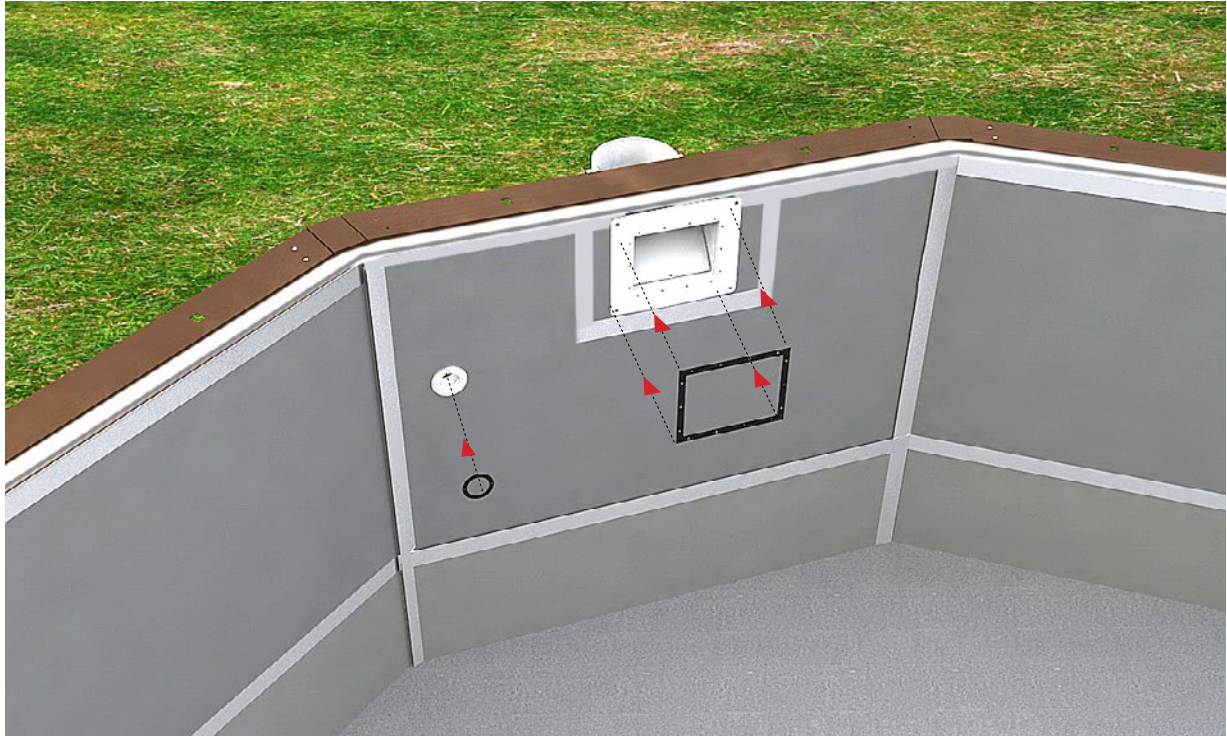

Verify that all joint holes are properly aligned with the Skimfiltre and outlet nozzle.

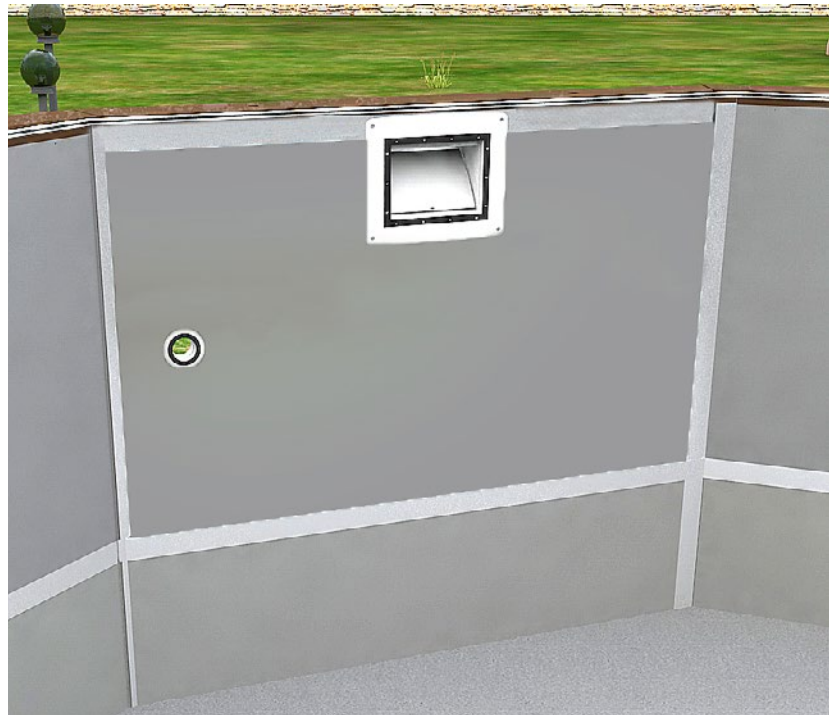
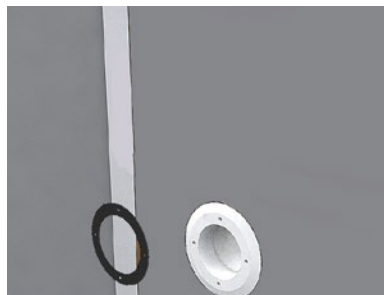

**IMPORTANT:**

An outside temperature of at least 20 degrees is necessary for the placement of the liner. We recommend that you remove your shoes before entering the pool and performing the placement of the liner

Unpack the liner inside the pool and unfold from the center toward the walls.

Place an angle of the liner ahead of an angle of the structure and repeat the same operation across the pool.



Insert horizontally the lip of the liner in the PVC anchorage support. The liner will be placed immediately when it is upright.

Make sure the liner is correctly placed, both on the ground, as the walls. Adjust the tension of liner pushing its angle inside of the angles of the pool.



Make sure the liner is correctly placed and has no folds. If small folds remain visible, you should, during the filling of the pool help the liner position correctly. Stop the filling as soon as the water level is 30 cm from the middle of the mouth of Skimfiltre.

Reaching this point of water, and after stopping water filling, place the joint lock and sealing rings to all embed parts.



### IMPORTANT :

Before starting the pool filling, we recommend the utilization of a vacuum cleaner to remove the air between the wall and the liner. You can use a domestic vacuum cleaner (without filter). Take out 10 cm. of the liner from the support and get the tube inside the opening until the height of the pool. Seal the opening caused by the tube of vacuum with adhesive tape. Put the vacuum to work for ten minutes and the liner will be laid on the floor and the walls of the swimming pool.





After installing the liner and filling the pool up to 30 cm from the middle of the mouth of the skimmer, you should locate the previously placed joints on the outlet nozzle and Skimfiltre.

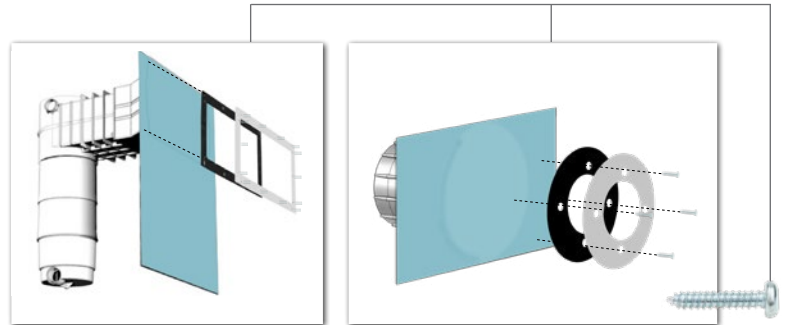

Then, overlap the joint and the flange of the parts and make the first hole, screwing the first screw. Once the second screw is placed all the other holes will be in the right position.

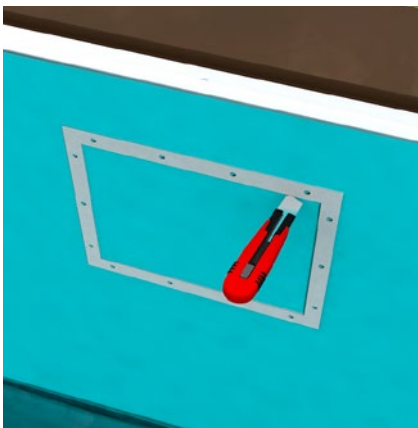

After screwing the flanges, cut the liner inside the flanges, using a cutter.

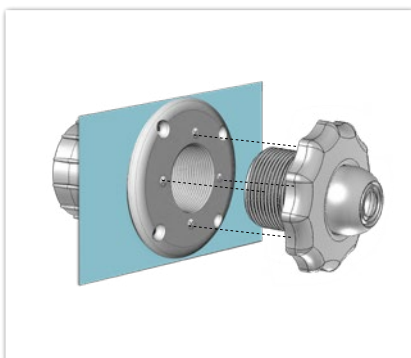
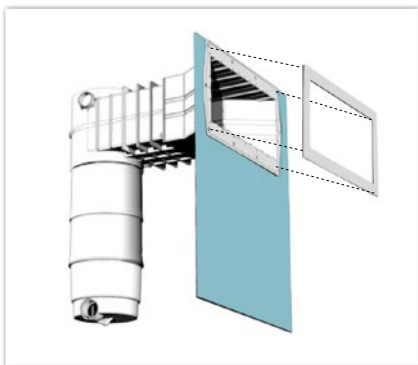

Once the placement and screwing of the outlet nozzle and skimfiltre flanges are done, place the mirror as shown in the illustrations.

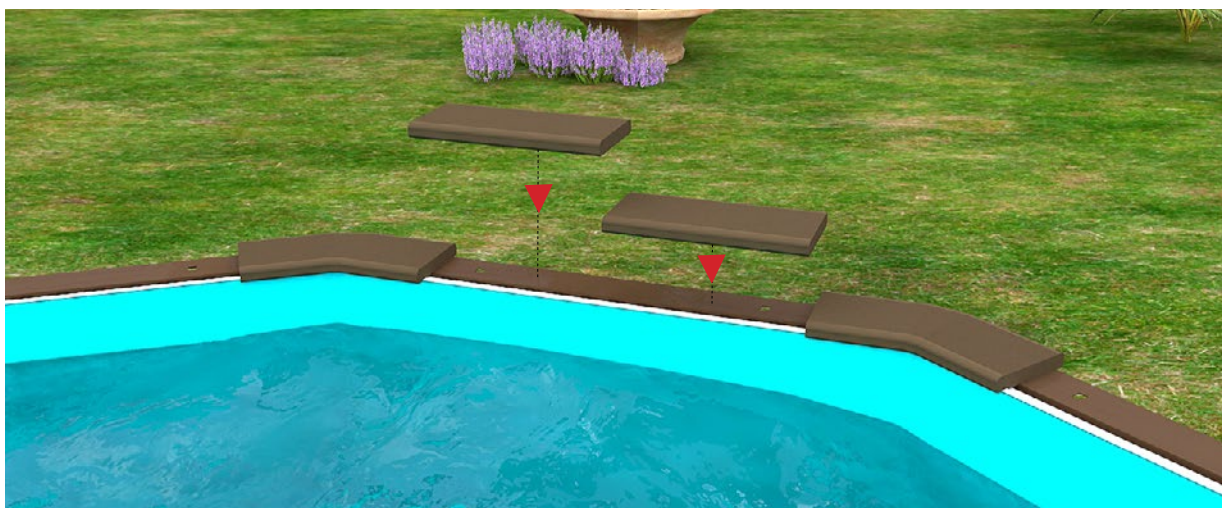

After the filling of the pool coping is fixed with the silicon supplied in the kit. The coping is made of two types of different elements: straight and angle coping. The straight copings are applied on the straight parts of the pool and the angle copings on the corners.



### IMPORTANT:

First, place all the angle copings without fixing them. Then, place the straight copings, bearing in mind the two pieces of copings conceived for the stainless steel ladder. Properly align all copings, leveling them up and make sure that in between all the pieces exist the same interval.



While placing the copings, you need to keep verifying if they are being leveled.

If you wish could do the coping joints with a special silicon (not supplied with the kit).

### Placing the coping

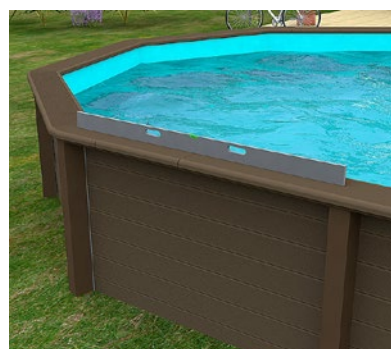



Following the instructions provided with the stainless steel ladder, proceed to the assembly and fixing it in the proper place, indicated for such.

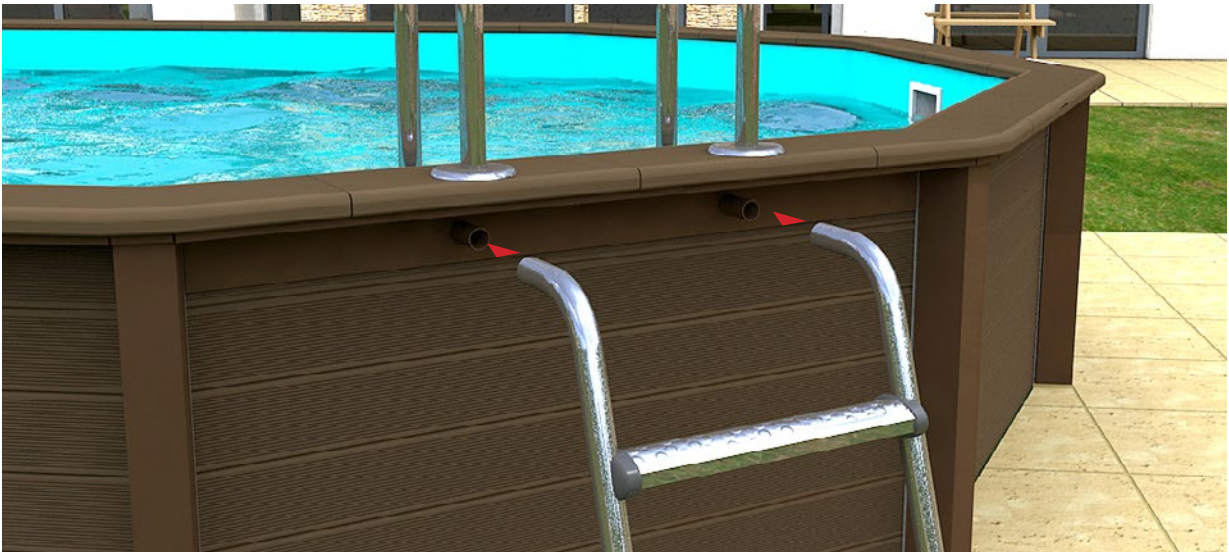

After fixing the indoor/outdoor stainless ladder the pool is ready for the first bath.



### ATTENTION:

For an above ground pool, remove the outside ladder after each use of the pool.  
For a semi-buried or fully buried pool, follow the current standard for private pools.



# STARTING THE FILTRATION

---

After you have finished filling the pool, run the filtration system.



## ATTENTION:

Make sure all joints and connections are tight, that the water level is sufficient and that the pump is connected to an electrical panel protected with a circuit breaker 30 mA (we recommend the use of a professional for this job).



**THE ACCESS TO THE POOL IS PROHIBIT IF THE FILTRATION SYSTEM IS DAMAGED**

## FILTRATION TIME

---

The system should be efficient enough to allow the renewal of the pool water every 6 hours (minimum).

The filtration time depends on the temperature of the water:

WATER TEMPERATURE 	FILTRATION TIME PER DAY 
below 0° C	24/24 hours – wintering the pool
1 to 15° C	2 hours
16 to 18° C	3 hours
19 to 21° C	4 hours
22 to 25° C	6 hours
26 to 28° C	10 hours
above 28° C	15 hours

## MAINTENANCE RECOMMENDATIONS

---

### During the season of use of the pool:

- The filtration system should work every day, the time required to secure at least a complete renovation of the water volume.

Check:

- Regularly the level of fineness of the filtering system
- Screws and nuts (for example: rust)
- The water level

It is imperative to check that the aspiration openings are not clogged; We advise you to stop filtering during the maintenance of the filtration system; It is imperative to quickly replace any damaged element or set of elements. Only use homologated products from the responsible for the product launch in the market.

**NOT RESPECTING THE MAINTENANCE INSTRUCTIONS CAN RESULT IN SERIOUS HEALTH RISKS, AND IN PARTICULAR TO CHILDREN.**

**THE UTILIZATION OF A POOL IMPLIES THE RESPECT OF THE SAFETY RULES OUTLINED IN THE MAINTENANCE AND OPERATION MANUAL.**



## CLEANING THE POOL AND THE WATER LINE

In the high season, it is imperative to aspire to the pool at least once every fifteen days. You should connect vacuum tube to the Skimfilre, then switching on the pump and vacuum. Finished vacuuming, we recommend cleaning the cartridge.

With a manual vacuum:

1. Connect the hose to the vacuum head
2. Insert the head of the vacuum in the water
3. With the filtration running, fill the tube with water, placing it ahead of an outlet nozzle
4. Attach the other end of the tube inside the Skimfiltre
5. Pass the vacuum head slowly to prevent dust from rising and do not remove it from the water
6. After vacuuming, clean the cartridge Skimfiltre.

As to the water line should be cleaned once a week, though it appears clean, so as to prevent the accumulation of fat, which at first sight, is not detectable.

Normally, you just need to use the wall brush provided with the kit to clean the water line. However, there may be fat and dirt embedded in particular in the steps or in the corners of the pool. In that case, apply without diluting a gel cleanser for the water line on a cloth or sponge and rub the affected area. If the dirt is situated very close to the water, then lower water level so that the product does not dilute and to obtain a more effective cleaning.

Leave it working for 5 minutes and wipe with a sponge.



### **ATTENTION:**

Never use abrasive products or thinners such as trichlorethylene, acetone, tetrahydrofuran, among others. These can cause irreversible damage to the liner of your pool.

## CLEANING THE SKIMFILTRE CARTRIDGE

During high season, you should clean the cartridge at least once a month and each time you use the vacuum cleaner. By the end of the high season, if you winter your pool, you may take out the skimfilter cartridge and keep it in a dry room.

You can clean the cartridge with a water jet, or after being dry with a brush.

## CLEANING THE PRE-FILTRE PUMP

Normally, with a skimfilter you do not need to clean the pumps pre-filter; except if you have a sand filter.

## WATER TREATMENT

---

No matter what filtration system used, you have to treat chemically the water of the pool in order to destroy bacterias, microorganisms and to avoid the algae developing.

Several sterilization products can be used, like chlorine, bromine, oxygen, salt electrolyzer or others.

The most usual treatment is the chlorine. We will give you some advice about it, this product can be purchased in supermarkets.



### **IMPORTANT:**

Once a week, do the PH and chlorine test. Not respecting the maintenance norms may cause some health risks, particularly for the children



## PH CONTROL

The pH control is essential for your pool because any product can't be truly effective with an unadjusted PH level. An unadjusted pH level can cause several problems such as skin, eyes or mucous membrane irritation. Moreover, an unbalanced pH level causes the decrease of the chlorine power, causing green water and deposits of calcareous. With the analysis kit supplied, you may check once a week the pH level. The pH levels must be imperatively situated between 7,2 and 7,6. This is considered the comfort area.



### **IMPORTANT:**

During the assembly and after filling, some micro-cracks may appear, that in no way change the characteristics and resistance of the pool, these cracks are not covered by the warranty.



### **ATTENTION:**

An adjusted level of PH is essential for your pool, mostly to maintain the quality of your liner.

An unadjusted PH level not only reduces the efficiency of chemical treatments as far as it causes in very short time spots or wrinkles on your liner, that are not covered by the warranty.

## CHLORINE LEVEL

The level of chlorine is measured in mg/l and it should be situated between 0,5 mg/l and 1,5 mg/l. You may check the level of chlorine in the water with the analysis kit supplied.

In each abrupt decrease of chlorine level, caused by high temperature or extreme weather conditions, you should do a shock treatment.



### **IMPORTANT:**

Never put chlorine tablets directly into to the pool. This will cause unaesthetic spots. Hydrochloric acid and copper sulfate are prohibited in the pool. Put the chlorine inside the skimfilter or in a floater.

## 5 IN 1 TREATMENT (SPECIAL FOR LINER)

If you want to use a concentrated product 3 in 1 or 5 in 1, verify that it's a product recommended for pools with liner.

Therefore, it's important to say that the 5 in 1 product is a stabilizer and not a corrector. So, if the water of the pool presents unadjusted levels, it is necessary to correct them using the adequate products. The necessary quantities for the water treatment are according to the volume of the water and the concentration of the product, we recommend following the instructions producer.

# SPECIAL CASES

---

## GREEN WATER TREATMENT

When the filtration is turned off during a long time, a high level of chlorine, and an excessive mixture of chemical products or after extreme weather conditions, the water of your pool can turn green, brown or even black. In this case, you may act immediately.

1. First, make a Ph and a chlorine analysis
2. Filtration must work continuously over 24h until the water become transparent
3. Readjust the PH and the chlorine
4. Make an intensive treatment of chlorine according to the advices of the producer
5. To facilitate the process of algae elimination, put inside the skimfilter a tablet of FLOVIL flocculant.
6. Once a day at least, clean the cartridge filter until the water becomes transparent
7. Once the water recovers the normal state, follow the given advice.
8. Check chlorine and PH levels once a week. If it necessary, increase or decrease the filtration according to the water temperature.

## HIBERNATION OF THE POOL

If you choose to stop the filtration and winterizing to the pool, you must have a winter cover. Ask some advice to your supplier.

After a complete cleaning of your pool (vacuuming, cleaning the skimfilter, cleaning the water line surface, etc) and have proceeded to an intensive treatment of the water, you may put inside the pool a winterizing product and start the system filtration for one hour until the product is totally dissolved, then:

1. Decrease the level of the water until 30 cm below the skimfilter
2. Drain hoses, tubes of the skimiter and the outlet nozzle
3. Take the cartridge out of the skimfilter and screwed a Gizzmo
4. Place a stopper in the outlet nozzle
5. Turn off the power of the pump
6. Drain the pre-filter of the pump and keep it in a dry room
7. Install floaters in the diagonal of the pool
8. Take out the stainless steel ladder
9. Put the cover on the pool
10. Put the peripheral stretcher inside the eyelets
11. Fixt he stretcher in the hooks situated under the coping.

We recommend the placing of a buoy under the cover to avoid that the rainwater accumulates in the pool.



## RESTART AFTER THE WINTERIZING

When the good days come back, you can restart the pool.

Remove the winter cover and wash it. Before the storage, dry it and then pack it.

Clean the coping and the water line surface.

Then adjust the level of the water.

If necessary, use the vacuum cleaner and brush carefully the walls and the bottom of the pool.

Then, follow the instructions in chapter "Green water treatment"

Your pool is now ready to be used and to give you unforgettable moments in family.

## CAUTIONS TO HAVE WITH A LINER

### AVOID:

Mechanical shock caused by the falling of objects in the swimming pool such as the stick of the parasol, garden furniture, telescopic pole, etc..

Acts of vandalism such as voluntary cuts...

The cutting of metals near the swimming pool.

A careless control of PH and a PH level under 7 cause the appearance of wrinkles in the liner.

If the chlorine level drops below 1 ppm, there is the probability of

- Propagation of algae and bacteria;
- The appearance of spots.

Failure to comply PH and chlorine dosage can cause the fastest discoloration of the liner.

The use of copper sulfate, copper or silver electrode, chemicals with copper content, may cause the appearance of yellow, gray or black stains in the water line.

Avoid contact with the liner with products that are not compatible with it, such as cosmetics, self-tanners, shields, etc.

All these products can be concentrated at the water line and, with the action of UV rays, definitely, tarnish the liner.

It's possible that you can see spots of different colors:

Pink: bacteria that are incorporated into the material.

Gray: halos caused by a fungus (wet ground)

Brown: spots arising from an insufficient treatment, resulting in algae growth.

The water temperature cannot exceed 32 ° C.

**IF YOU WISH TO COMPLETELY EMPTY YOUR POOL,  
SEE YOUR DEALER**

# WARRANTY

---

For any complaint or After Sales Service, you must keep the assembly direction with the guarantee code on the back and the proof of purchase (invoice or receipt).

In order to validate your guarantee, please access [www.naturalisrp.com](http://www.naturalisrp.com) and follow the instructions.

You have 60 days from the date of leaving of the factory to validate the guarantee\*. After this period, the owner will have to submit a new request for review by accessing the website [www.naturalisrp.com](http://www.naturalisrp.com) entering the guarantee code and presenting the proof of purchase. A description and pictures may be requested.

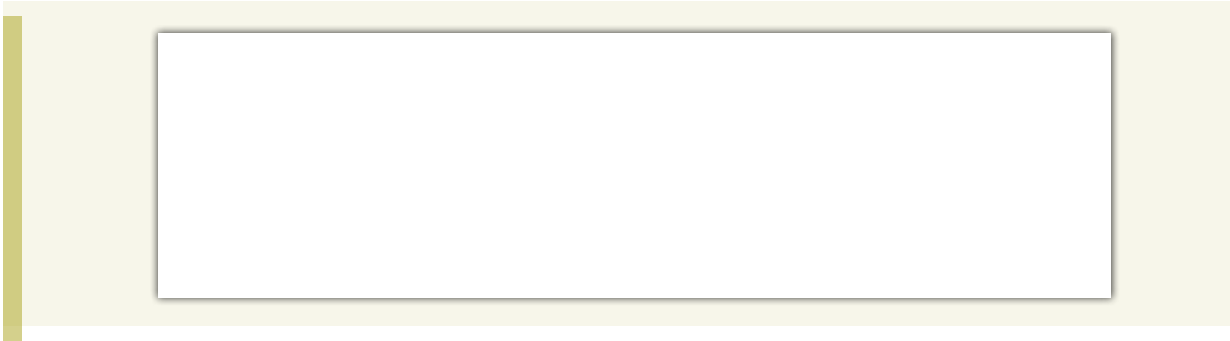

The QR code (■) is a 2D barcode that can be easily read with most of the mobile devices with a camera. The code is converted into an internet address that will allow you to validate the guarantee of the pool, by automatically accessing the browser.

## DURATION OF THE WARRANTY:

- **Structure:** 10 degressive years for the walls and surrounds against ice and thaw. Degressivity of 10% per year.

Due to its composition, the structure and the copings may show efflorescences and / or slight discoloration over the years, which in no way change the characteristics and resistance of the pool, and which are not covered by the guarantee.

During the assembly and after filling, some micro cracks may appear, that in no way change the characteristics and resistance of the pool, cracks that are not covered by the warranty.

- . **Liner:** 10 years, only on the welding, with a gradual reduction of 10% per year.
- . **Pump:** 3 years warranty according to current legislation
- . **Skimfilter:** 3 years warranty according to current legislation (except cartridge)
- . **Ladder:** 3 years warranty according to current legislation (unless you use a salt device).

Are excluded from warranty:

- Cuts, holes, folds, wrinkling, tears, pullings, color maintenance, patches of any kind
- The cut and put in the water
- Maintenance
- The Wintering.

The warranty is excluded in the following cases:

- Installation or use not in accordance with our instructions
- Damage caused by mishandling of the product.



## **AFTER SALES SERVICE**

---

The after-sales service will be handled only with the points of sale.

For handling complaints or warranty claims fill out the form on the site [www.naturalisrp.com](http://www.naturalisrp.com) and return to the respective point of sale.

## **RETURN OF MERCHANDISE**

No goods return will be allowed without prior consent from our company. All goods return is borne by the customer (wrapping, packaging, and transport).

## **AFTER FINDING AND VERIFICATION OF A MANUFACTURING DEFECT:**

- The defective products will be repaired effectively or replaced with postage paid.
- For products not covered by the warranty, a quote will be prepared. Upon acceptance of this by the customer, the parts will be redirected.

In the event of a replacement for a defective element, disassembly and assembly are not met by our company.

The warranty is limited to repair or replacement of the defective part. The warranty does not determine in any case, compensation for damages.

## **STORAGE PRECAUTIONS**

While the pool is not installed, some care is needed for storage:

- Avoid moving the pallets without suitable transport
- Storing the pallet directly in a leveled ground and a sheltered space

Este projecto é propriedade da R.P Industries, sendo expressamente proibida a sua reprodução total ou parcial sem autorização da empresa, sendo punidos os casos mediante a lei em vigor.  
Ce plan est propriété de la société R. P. Industries. La reproduction totale ou partielle est interdite, sans autorisation expresse de celle-ci. Toute infraction sera punie conformément à la loi en vigueur.

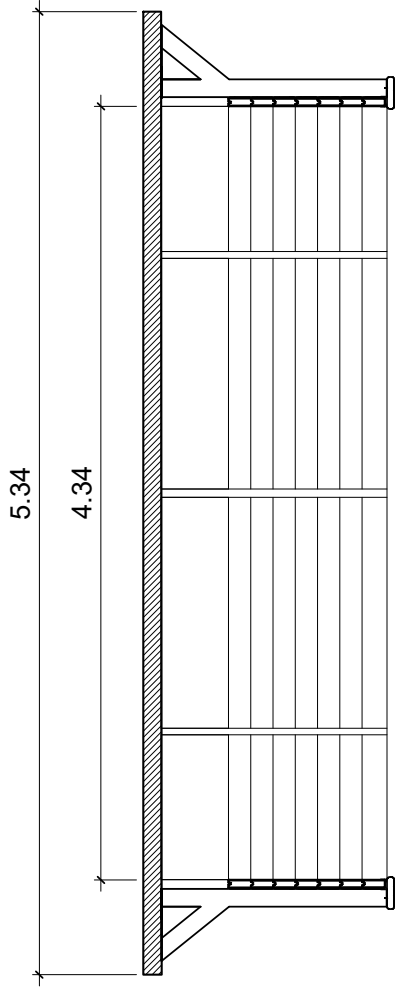

Concrete slab 0.10m

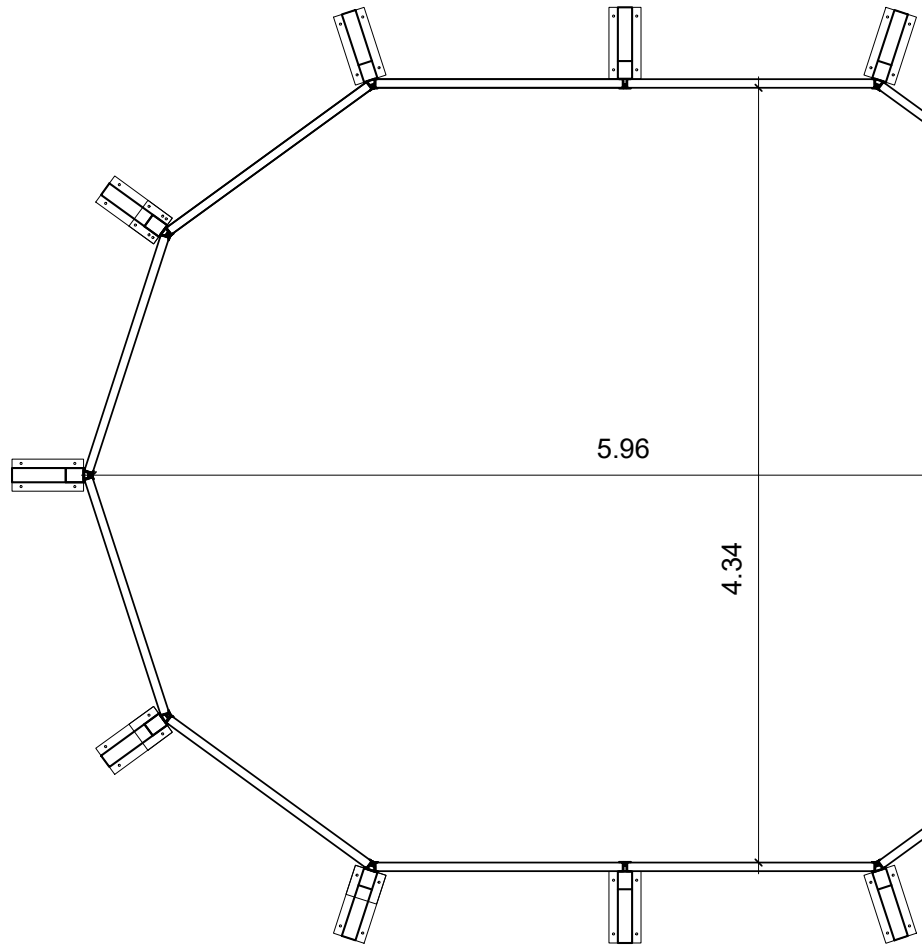
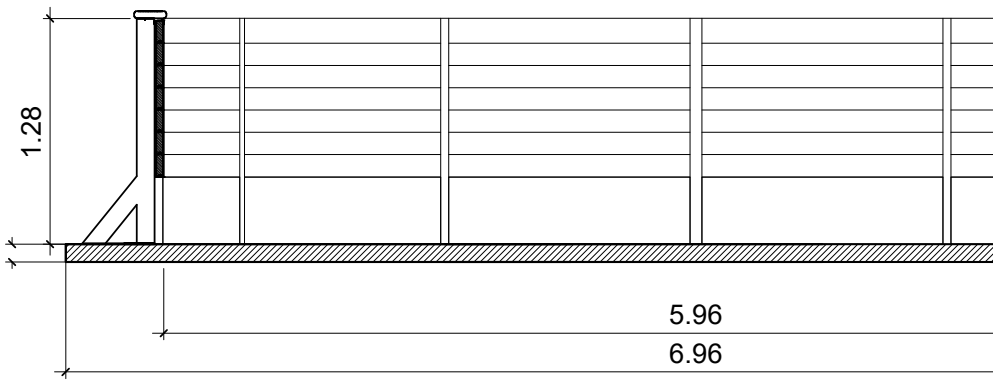





www.naturalisrp.com info@naturalisrp.com

Pool:	<b>Decagonal elongated 4.34x5.96m</b>			
Ref.:	<b>NATURALIS 02</b>	Des.:	José Azevedo	
Scale:	Date:	Surface:	Perimeter:	Volume:
1/50	27/05/2020	21.43m <sup>2</sup>	16.91m	23.50m <sup>3</sup>

Quant.	Description of the KIT
--------	------------------------

**Structure**

10	Angle pillar
2	Straight pillar
12	Mirror for angle pillar (10) and straight pillar (2)
8	Support base nr.1
2	Support base nr.2
2	Support base nr.3
4	Triangular reinforcement
1	Skimmer Panel
12	Wall rail nr.1
57	Standard wall rail nr.2
11	Superior wall rail nr.3
1	Wall rail - outlet nozzle nr.4
2	Wall rail - skimmer nr.5
10	Angle coping
24	Straight coping
2	Straight coping - ladder (right + left)
12	Aluminum profile - base
10	PVC Hung profile - angle
14	PVC Hung profile
7	Coping support nr.1
2	Coping support nr.2
2	Coping support nr.3
1	Coping support - ladder
12	Steel plate 1440x855

**Filtration**

1	Skimfilitre 12m3/h C3
1	Outlet nozzle
1	Pump 3/4
10ml	Semi-rigid tube Ø 50
1ml	Rigid tube
4	Curve 90° - Ø 50
2	Válve + 2 junctions
2	Teflon roll
1	PVC glue 250cc

**Coating**

43m <sup>2</sup>	Liner "Bleu pâle" 75/100 with Mosaic frieze
25m <sup>2</sup>	Geotextile
17m	Locked profile
1	Aluminum adhesive tape
1	RP INDUSTRIES adhesive tape

**Accessories**

1	Built-in ladder - stainless steel
1	Outside ladder - stainless steel
1	Flexible tube (6m)
1	Telescopic pole
1	Manual vacuum
1	PH/CH analysis kit
1	Leaf skimmer
1	Thermometer
16	Special glue for concrete and metal

**Fixation**

92	Metal bushing for fixing pillar, base support and triangular reinforcement
24	Screw M10x30 for fixation of support base to pillar
72	Screw M4x10 aluminum profile for attachment to base support
56	Screw M6x16, nuts for fixing coping support
144	Screw M4.2x16 for fixing of the hung profile and steel plate
8	Screw M6x16, nuts for fixing of the triangular reinforcements

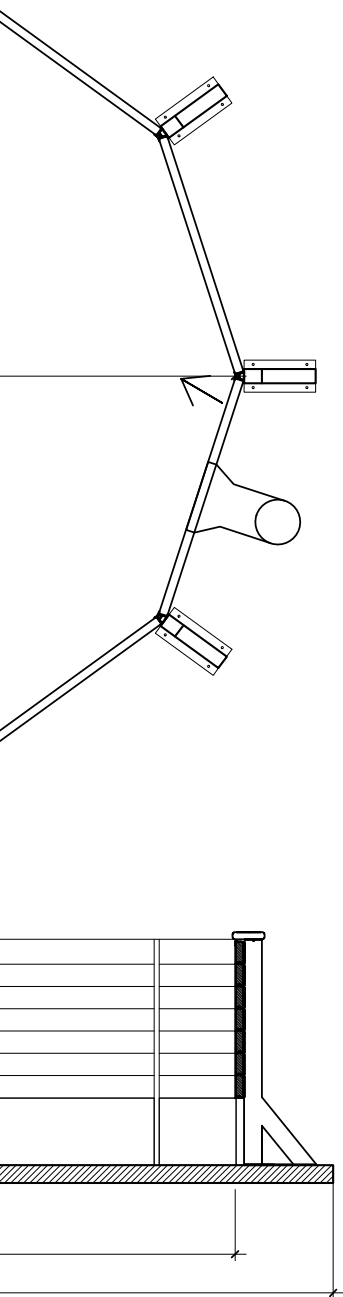

# Naturalis Installation Versions

## NATURALIS - STANDARD INSTALLATION

### half buried version

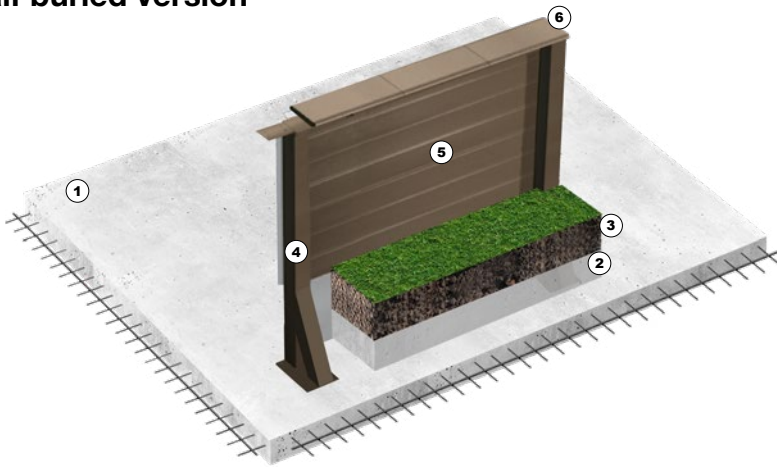

- ① Concrete slab <sup>(1)</sup> with sun-mesh - 10 - 12 cm height
- ② Concrete ribbon<sup>(2)</sup> - 20 cm height
- ③ Landfill
- ④ Naturalis pillar
- ⑤ Naturalis crossbars
- ⑥ Naturalis coping

<sup>(1)</sup> The concrete slab must be made with adequate strength: 350 kg of concrete per m3 and a sun-mesh application with a 4 mm iron. Its execution must be completed at least 2 weeks before installing the Naturalis pool kit.

<sup>(2)</sup> We recommend the creation of a 20 cm high concrete belt to be made around the perimeter of the pool.

## NATURALIS - ALTERNATIVE INSTALLATION

### elevated version

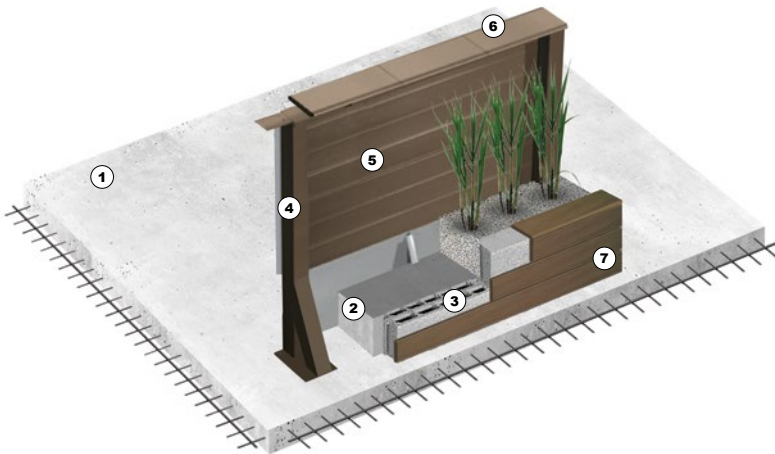

- ① Concrete slab <sup>(1)</sup> with sun-mesh - 10 - 12 cm height
- ② Concrete ribbon<sup>(2)</sup> - 20 cm height
- ③ 20 cm blocks to cladding support
- ④ Naturalis pillar
- ⑤ Naturalis crossbars
- ⑥ Naturalis coping
- ⑦ Claddings in:
  - reconstituted natural stone;
  - pedra natural stone ;
  - wood;
  - ceramic;
  - others.

<sup>(1)</sup> The concrete slab must be made with adequate strength: 350 kg of concrete per m3 and a sun-mesh application with a 4 mm iron. Its execution must be completed at least 2 weeks before installing the Naturalis pool kit.

<sup>(2)</sup> We recommend the creation of a 20 cm high concrete belt to be made around the perimeter of the pool.

## NATURALIS - ALTERNATIVE INSTALLATION

### buried version

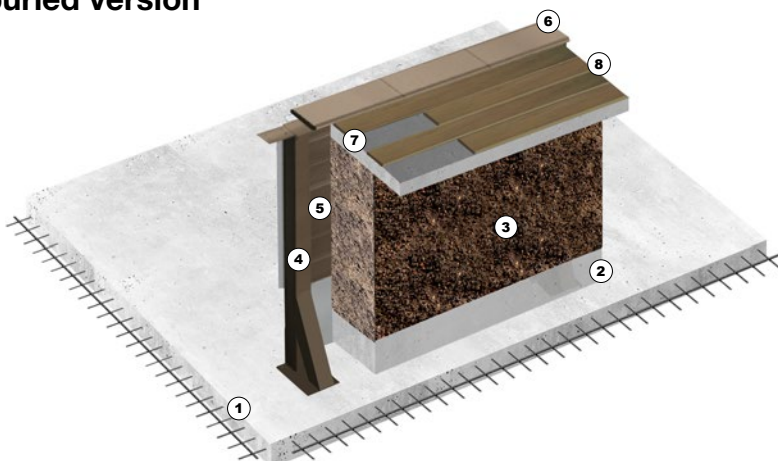

- ① Concrete slab of 10 - 12 cm height
- ② Concrete ribbon<sup>(2)</sup> - 20 cm height
- ③ Landfill
- ④ Naturalis pillar
- ⑤ Naturalis crossbars
- ⑥ Naturalis coping
- ⑦ Concrete slab for pavement
- ⑧ Pavement / grass

<sup>(1)</sup> The concrete slab must be made with adequate strength: 350 kg of concrete per m3 and a sun-mesh application with a 4 mm iron. Its execution must be completed at least 2 weeks before installing the Naturalis pool kit.

<sup>(2)</sup> We recommend the creation of a 20 cm high concrete belt to be made around the perimeter of the pool.





The QR (📄) code is a 2D barcode that will allow you to make the validation of the pool guarantee, automatically accessing the browser.  
The validation of the warranty is limited to a period of 60 days after factory shipping date.



**RP INDUSTRIES, SA**  
Parque Industrial de Sobreposta, Rua da Piscina, nº 70  
Braga - Portugal

**[info@naturalisrp.com](mailto:info@naturalisrp.com)**  
**[www.naturalisrp.com](http://www.naturalisrp.com)**