

44mm
+/-mm

BAS49-3

657x457cm h131cm

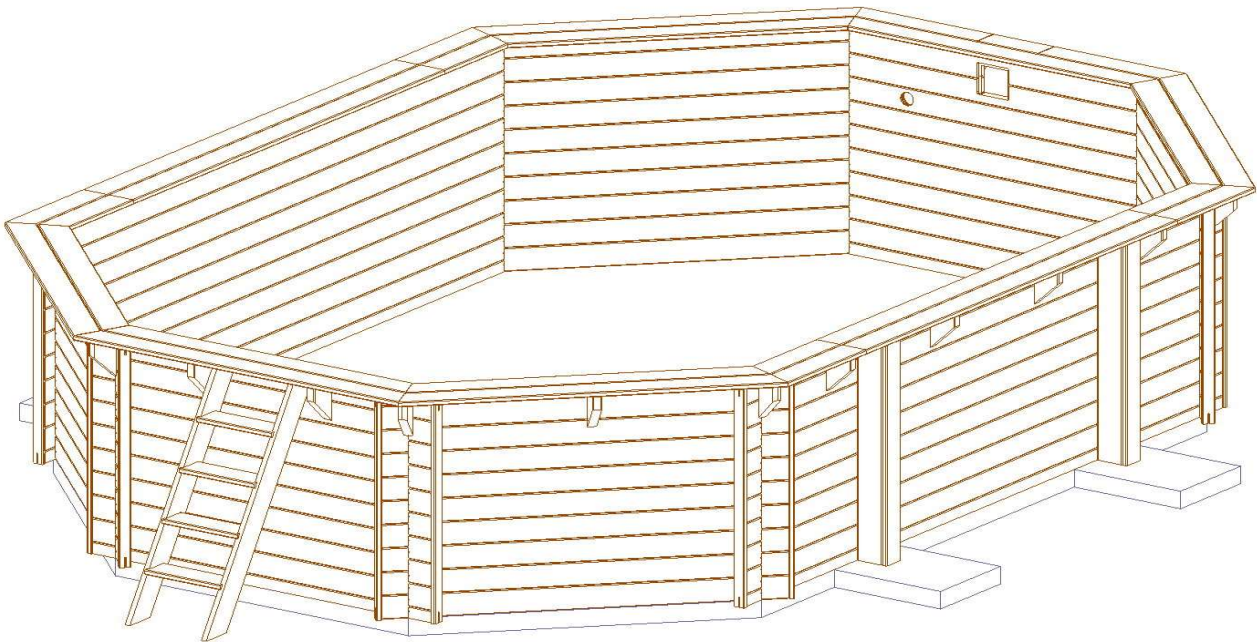





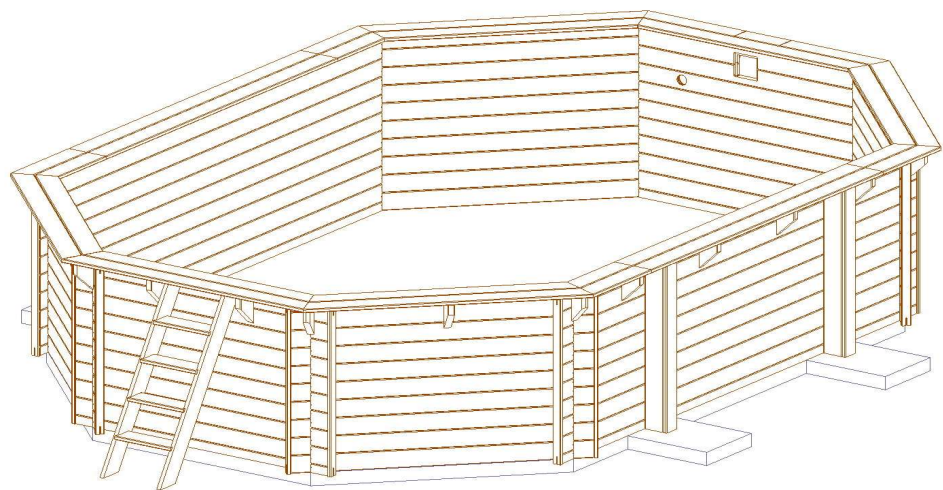
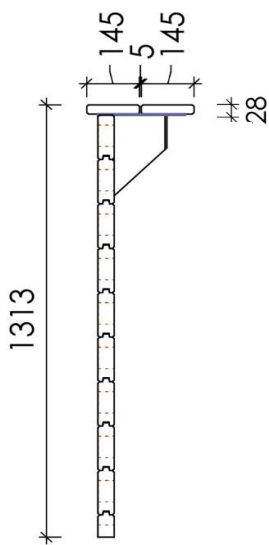
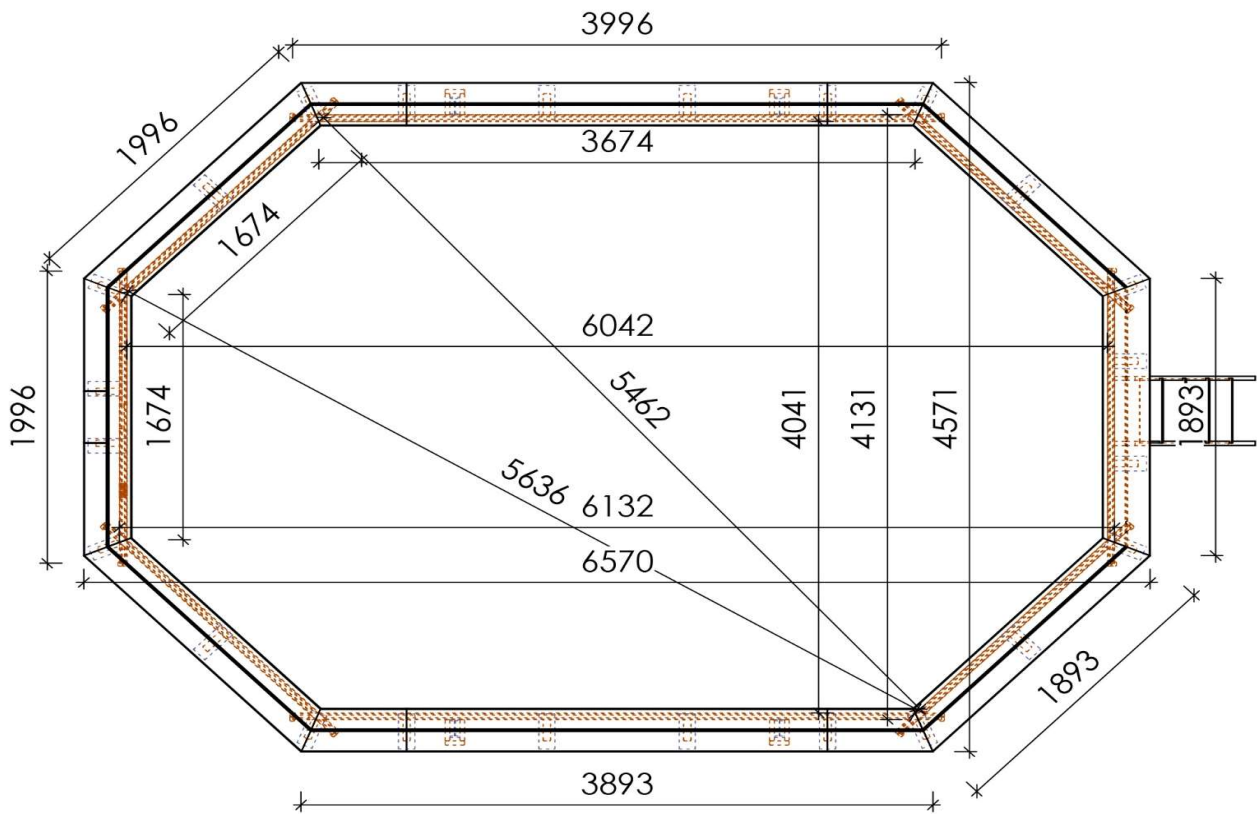
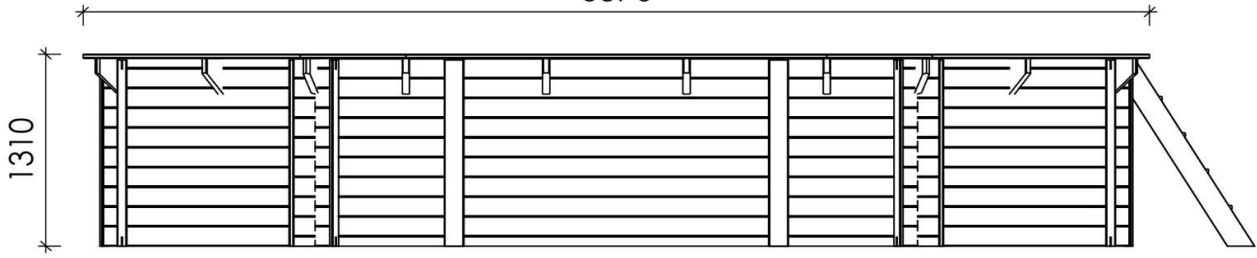





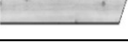
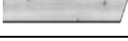
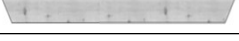
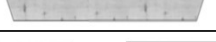























BAS49-3 657x457cm
h131cm 44 +/-1mm

6570

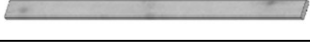
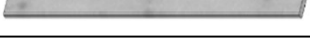

BAS49-3 657x457cm h131cm

Nr	Element	Size			pcs	A	B
		d	h	L			
1		28	145	2593	4		
2		28	145	650	2		
3		28	145	588	2		
4		28	145	650	2		
5		28	145	588	2		
6		28	145	1893	5		
7		28	145	1769	6		
8		28	145	767	2		
9		28	145	350	1		
10	 	45	145	3996	16		
11	 	45	135	3996	2		
12	 	45	78	3996	2		
13	 	45	145	1996	50		
14	 	45	135	1996	1		
15	 	45	78	1996	2		
16	 	45	67	1996	4		
17	 	45	135	1996	1		
18	 	45	145	1996	1		
19	 	45	145	1996	1		
20		28	145	1544	1		
21		28	145	1544	1		
22		28	145	440	4		
23	 	45	145	245	16		
24	 	45	145	245	8		
25		28	60	1270	16		
26		28	145	1270	8		
27		28	120	1270	4		
28		58	120	1700	4		
29		10	10	500	4		

A x2

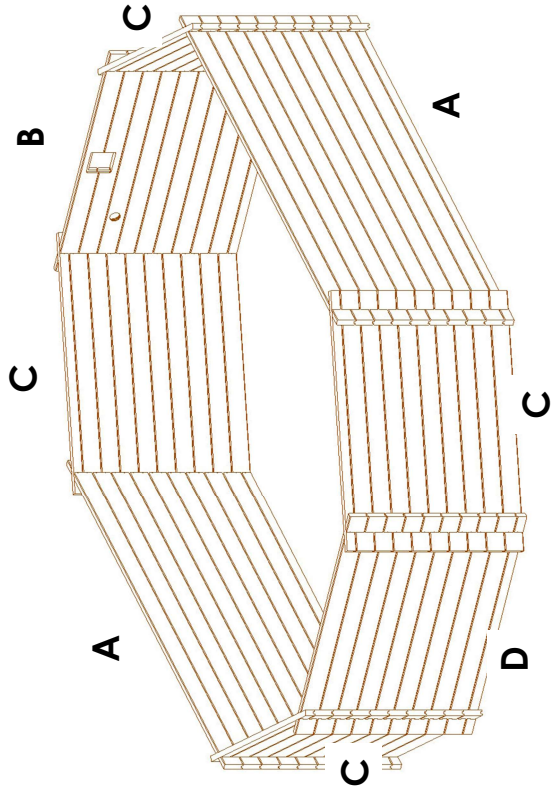
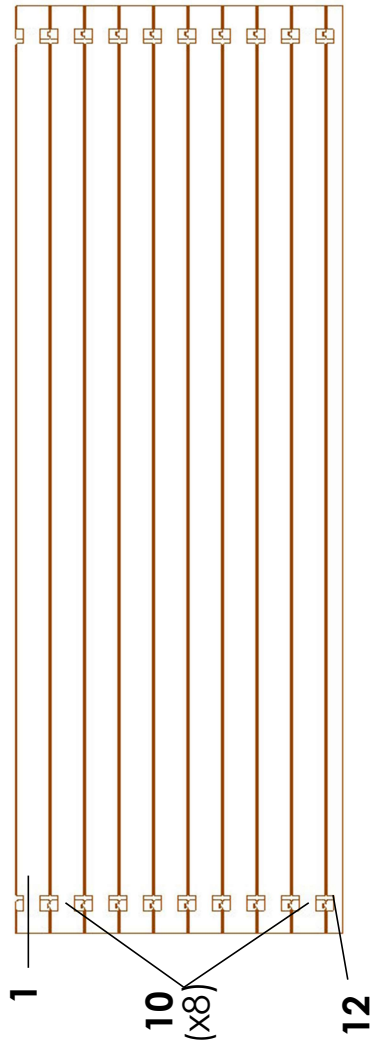

B

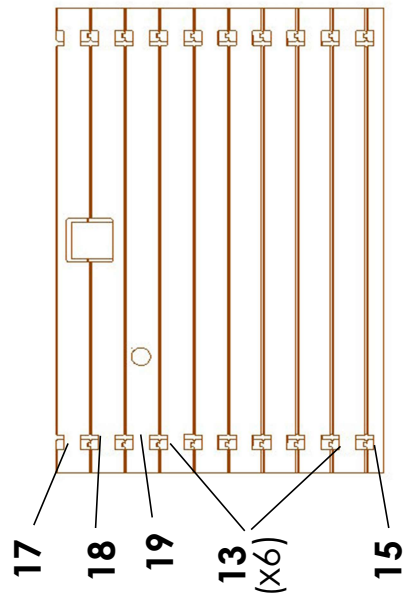



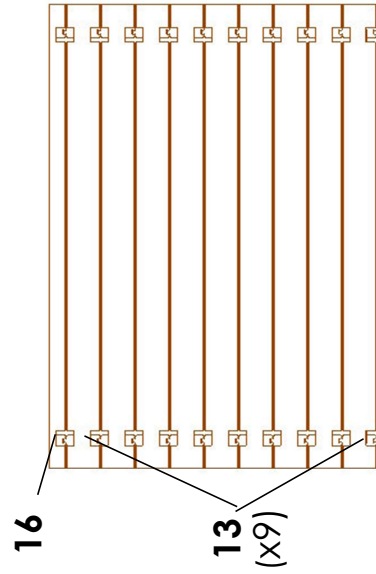



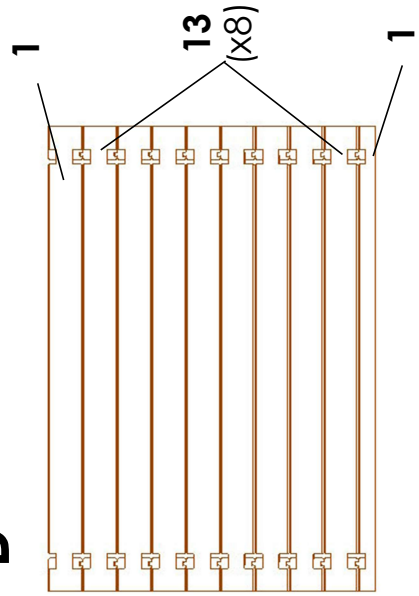

C x4



D



Nr	Element	Size	pcs	A	B
A		3,0x25	12		
B		3,5x25	300		
C		5x80	32		
D		4,5x60	84		
E		5x100	84		
F		3x100x240	24		
G			2		
H		40x40	2		

Outils

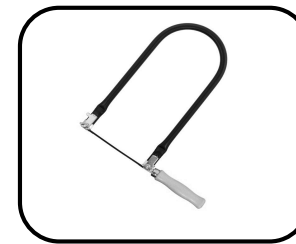
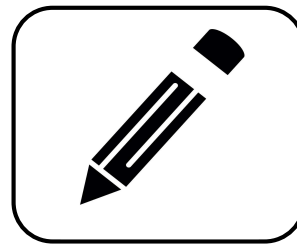
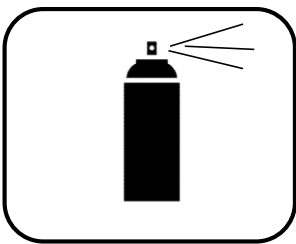
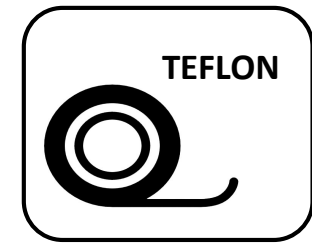
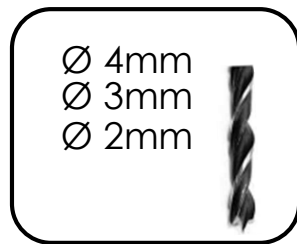
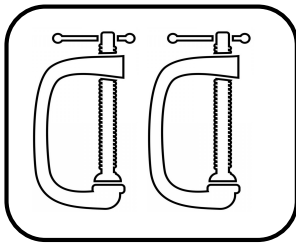
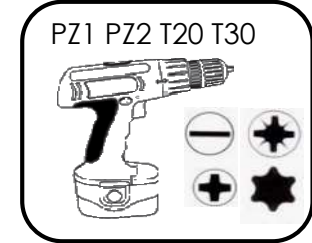
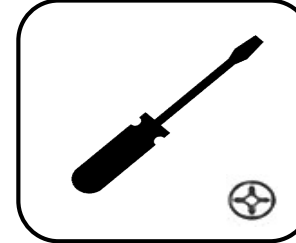
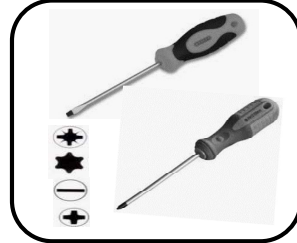
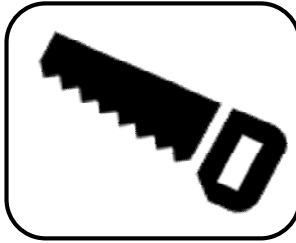
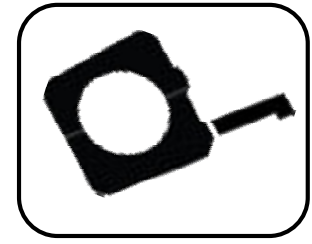
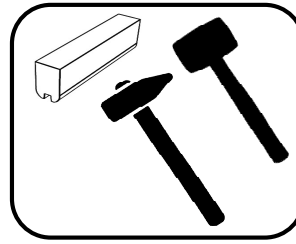
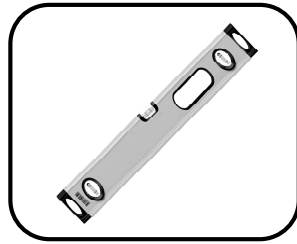
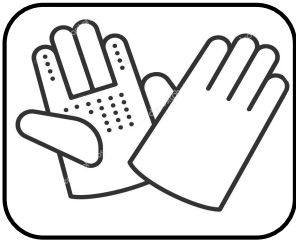

Important

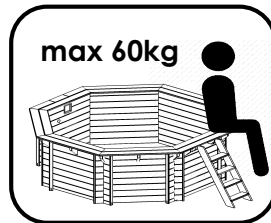
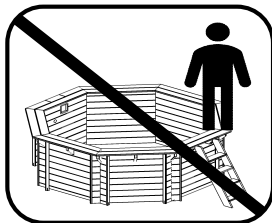
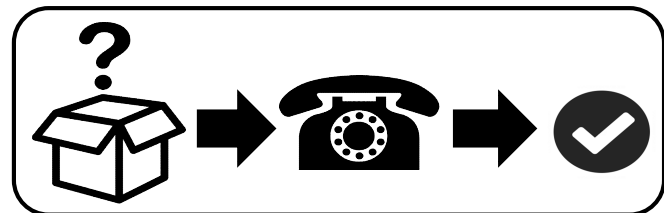
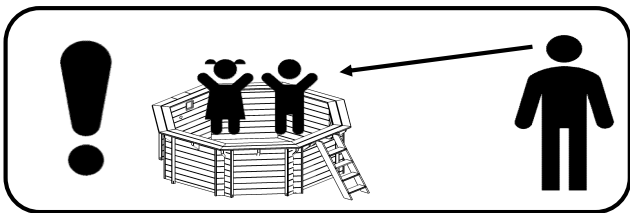
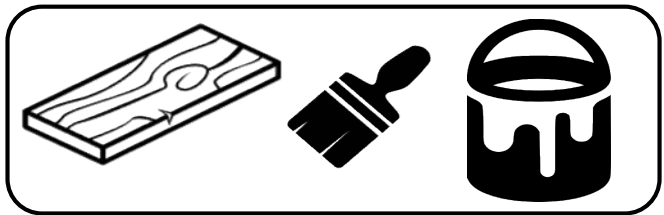
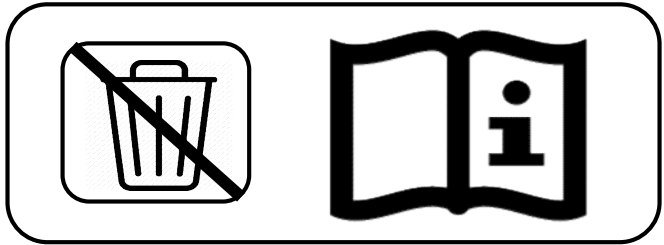
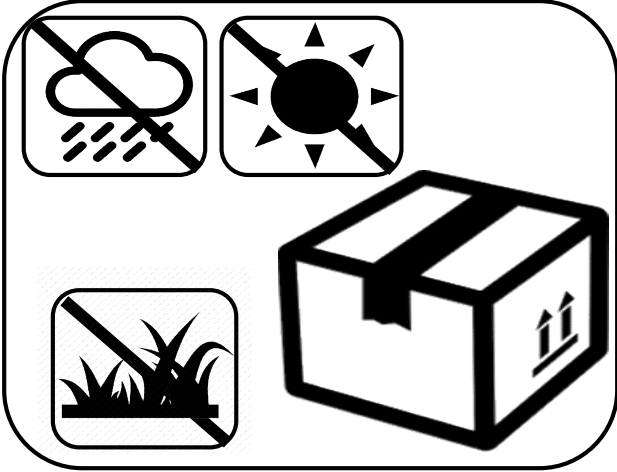
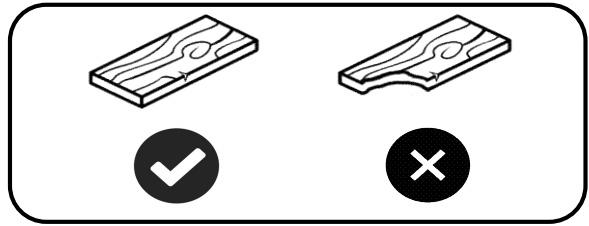
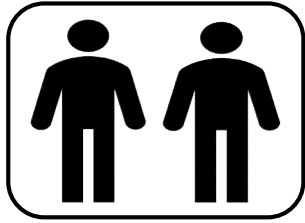
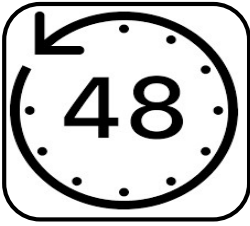

Terrain

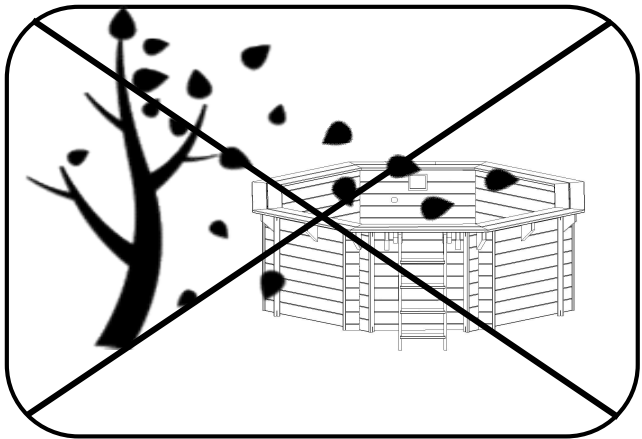
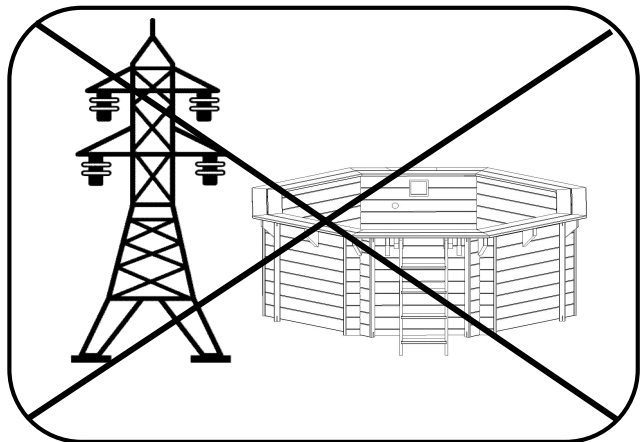
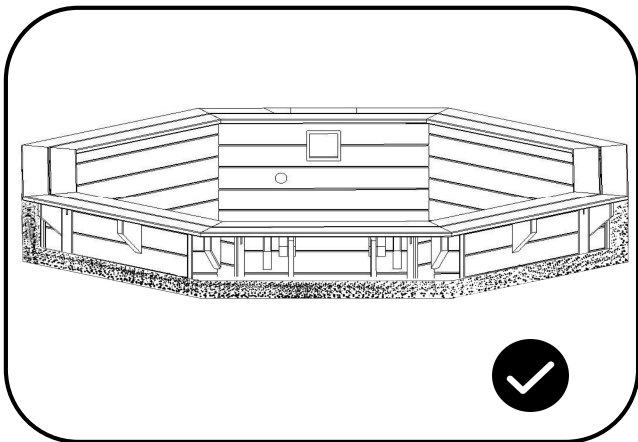
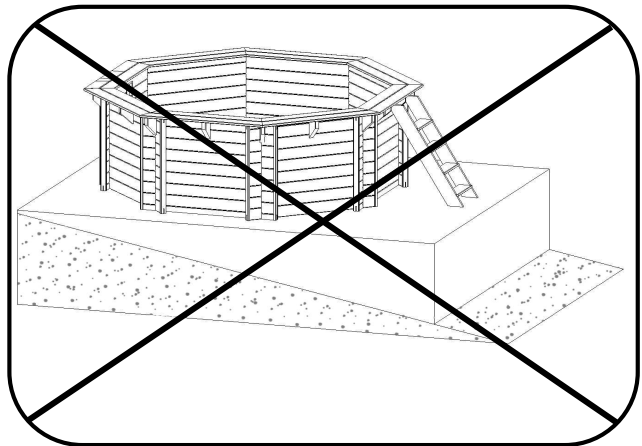
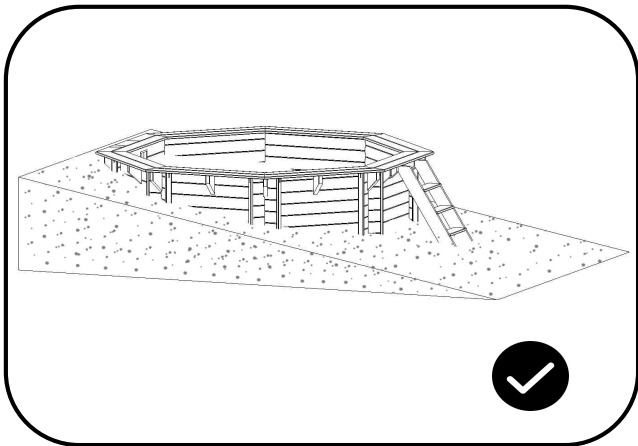
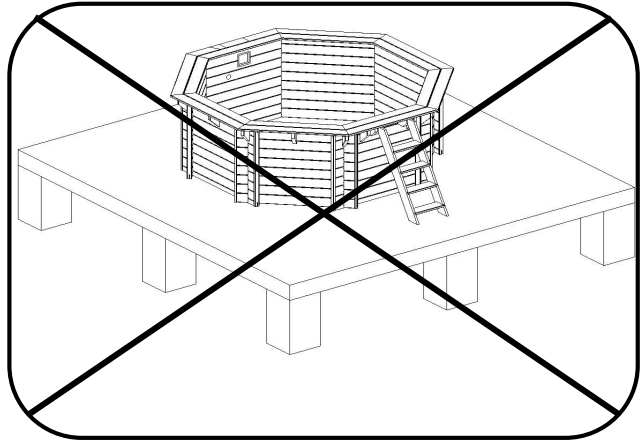
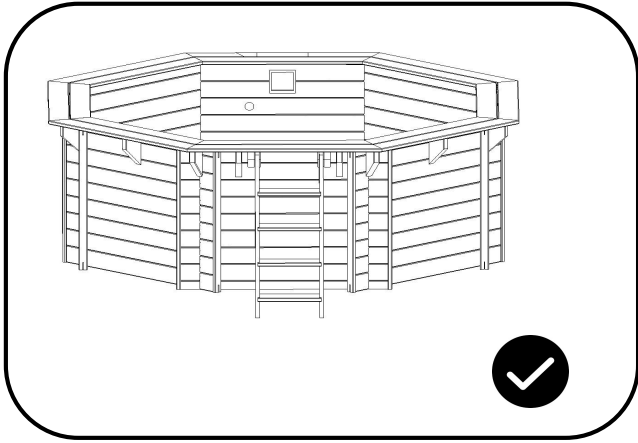

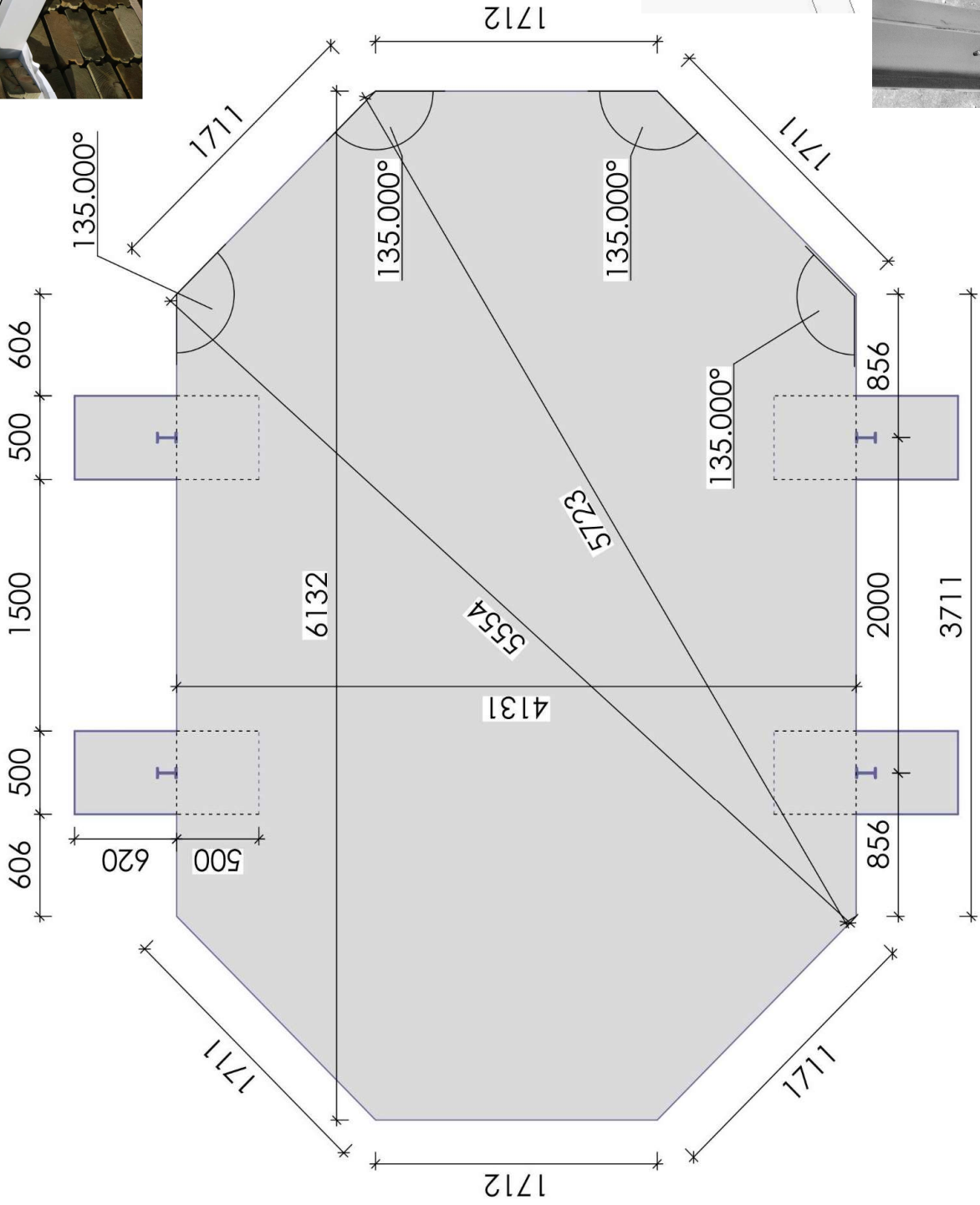
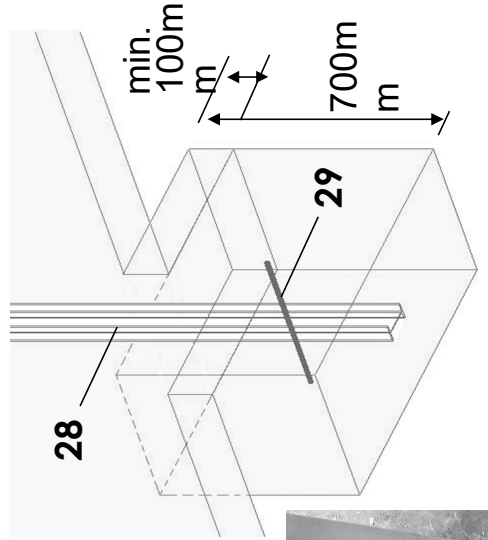
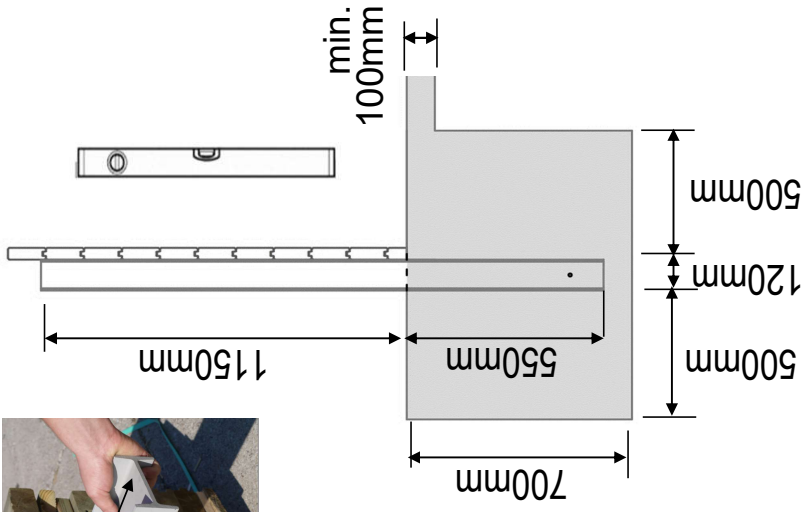
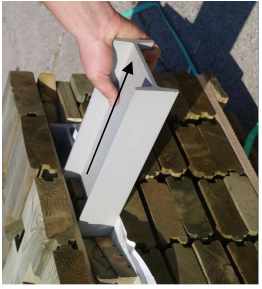

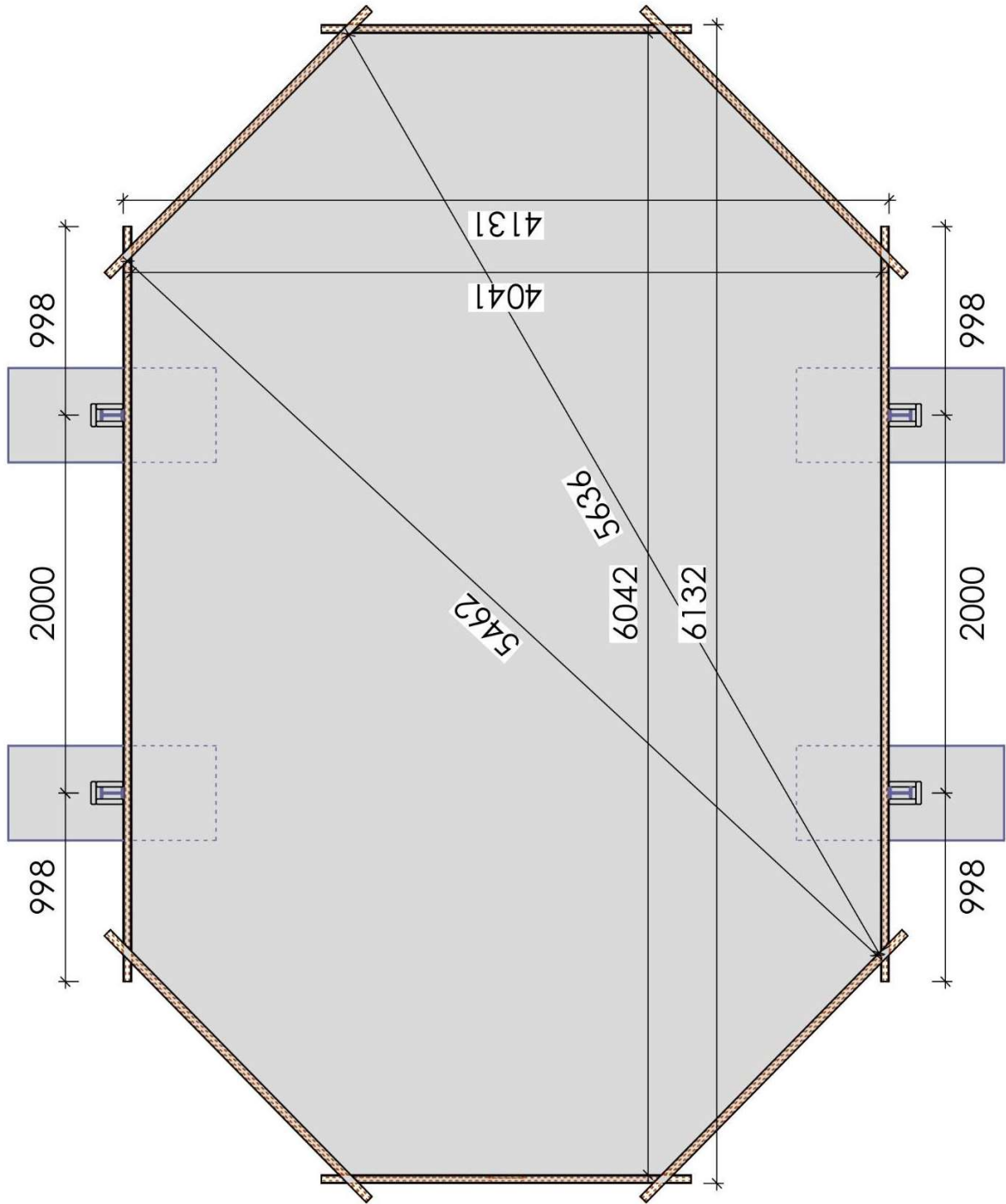
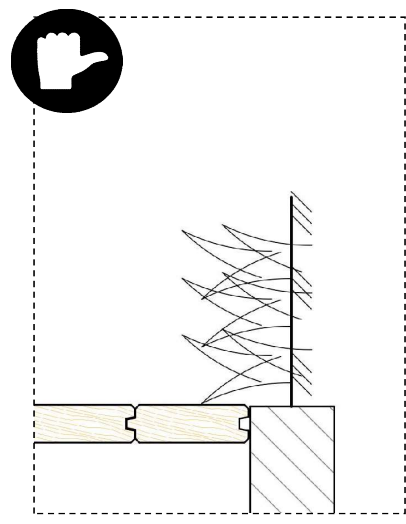
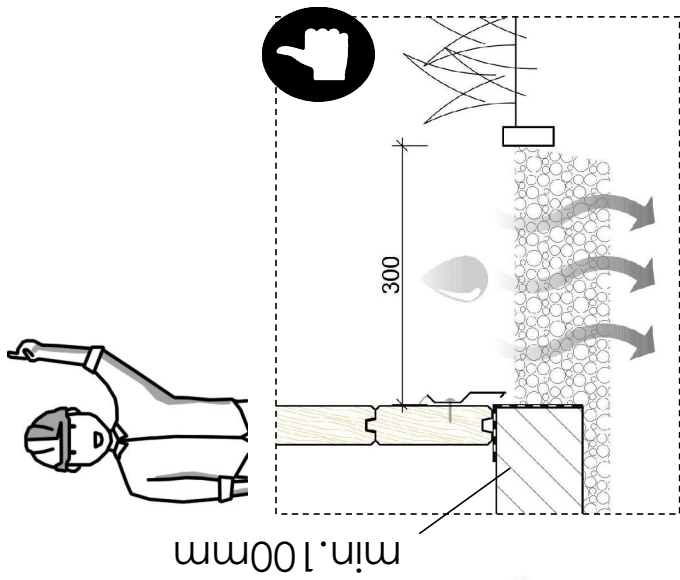

1

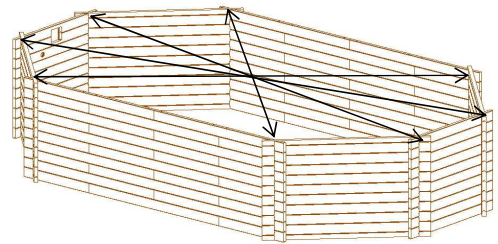
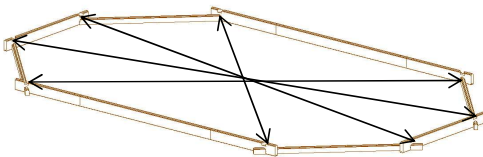
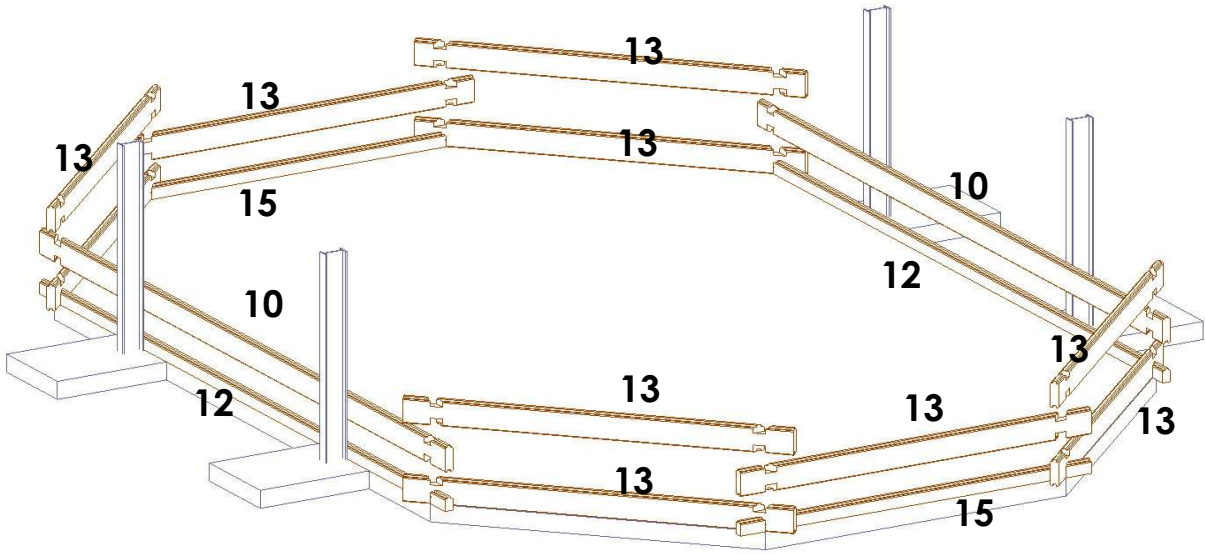
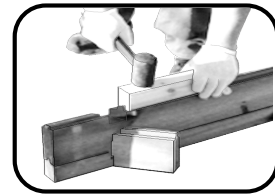
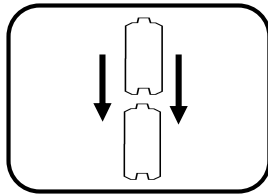
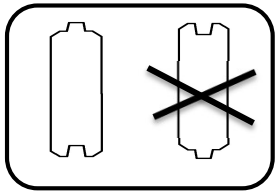

2

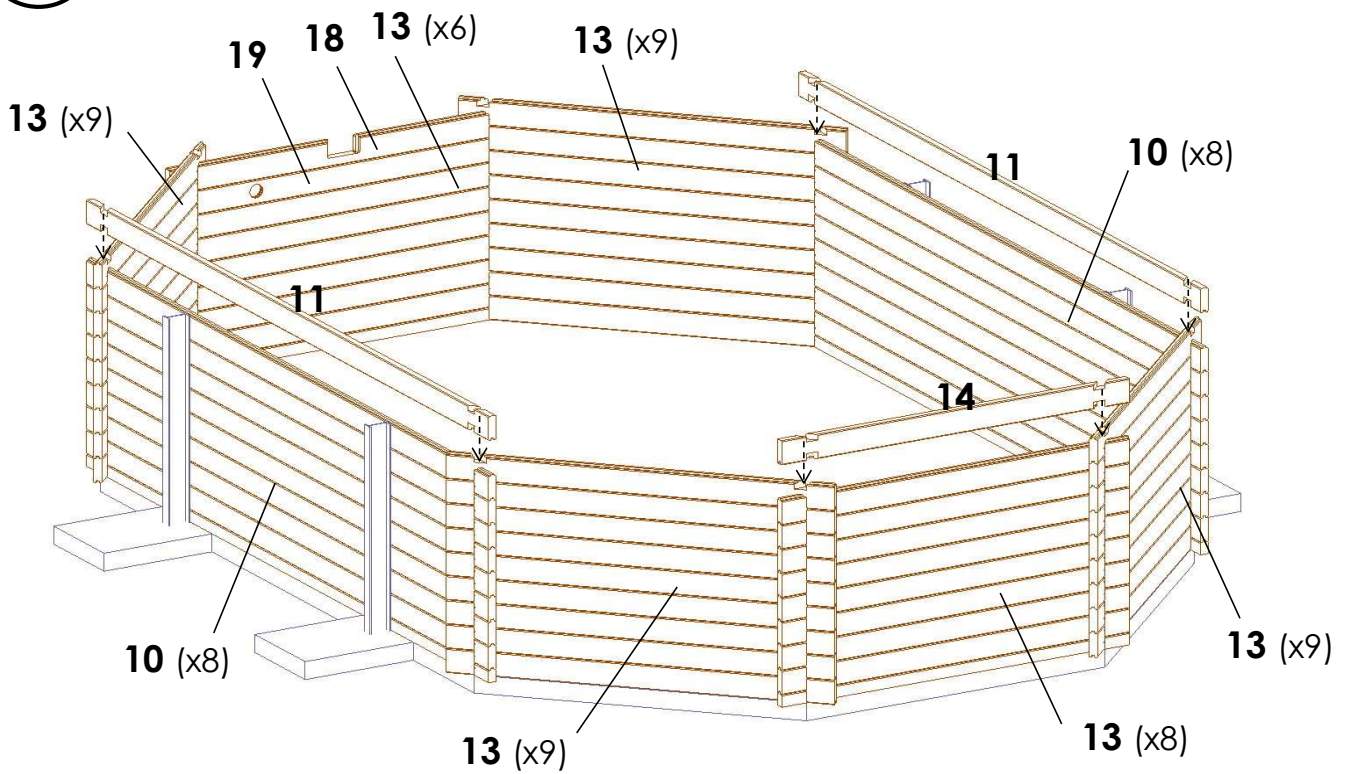

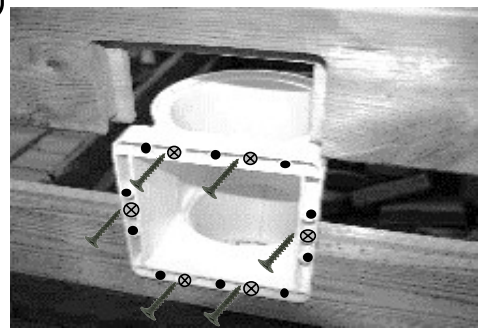
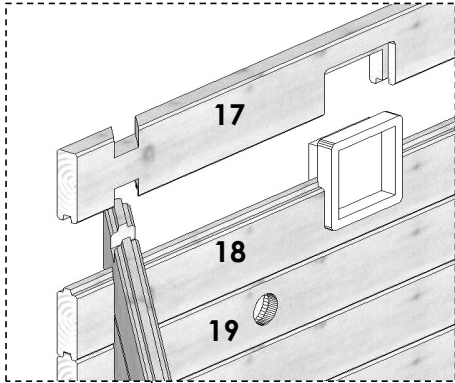

Ø4,0x40 (x6)



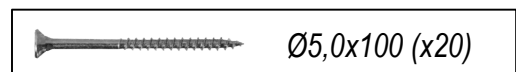
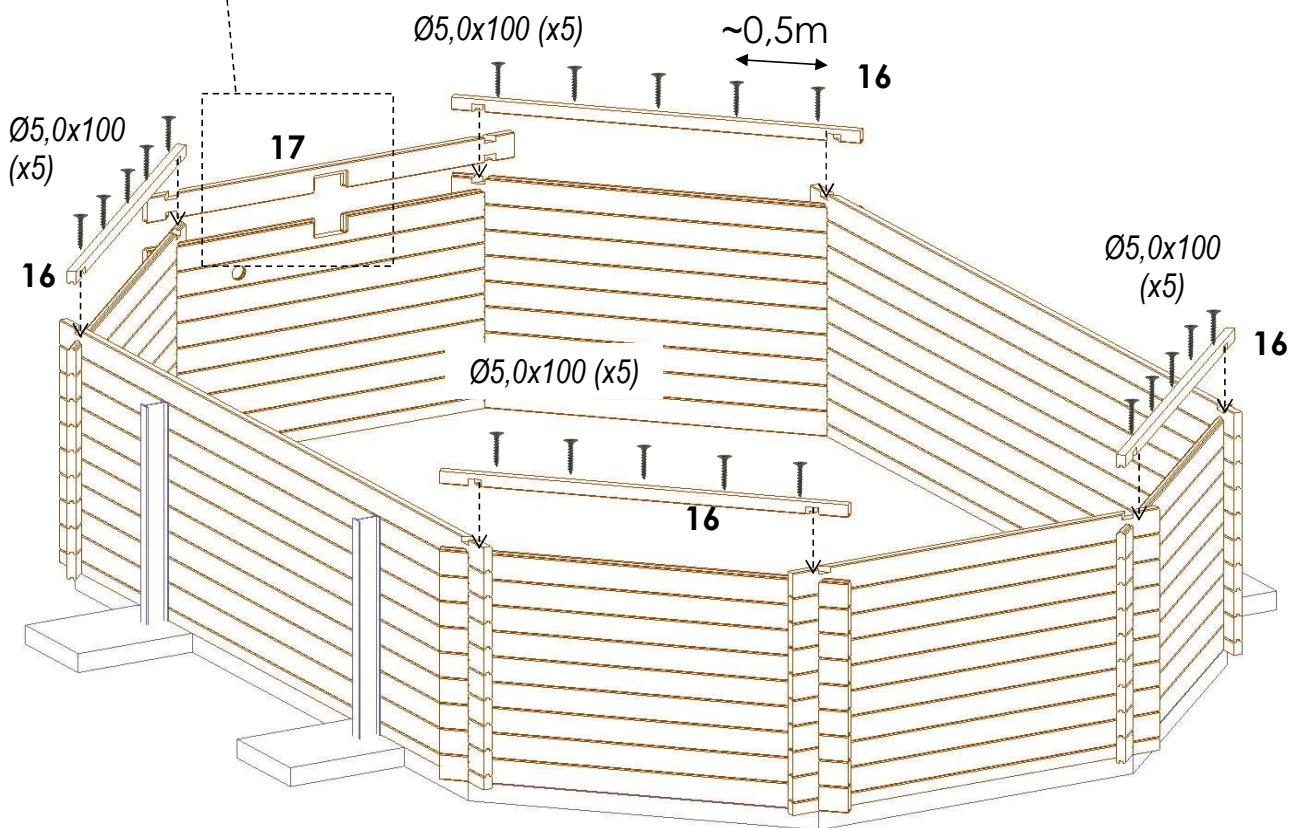

+ Ø4,0x40 (x16)

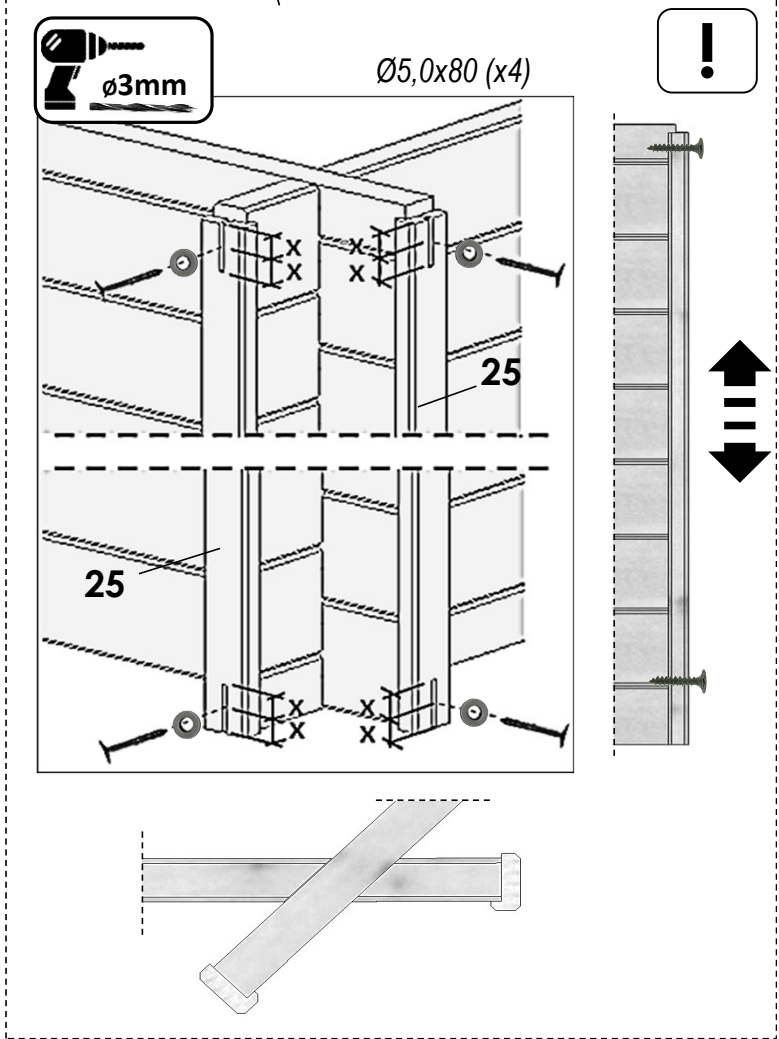
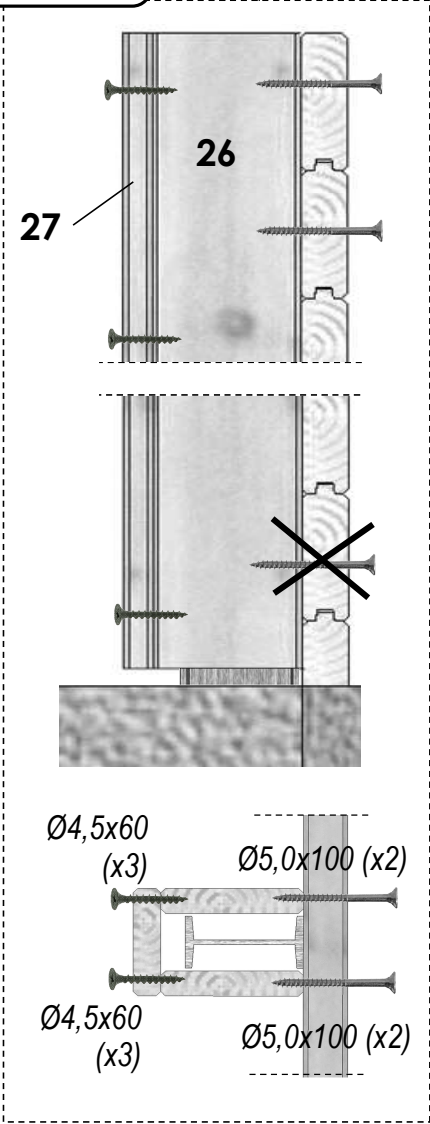
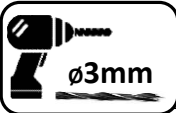
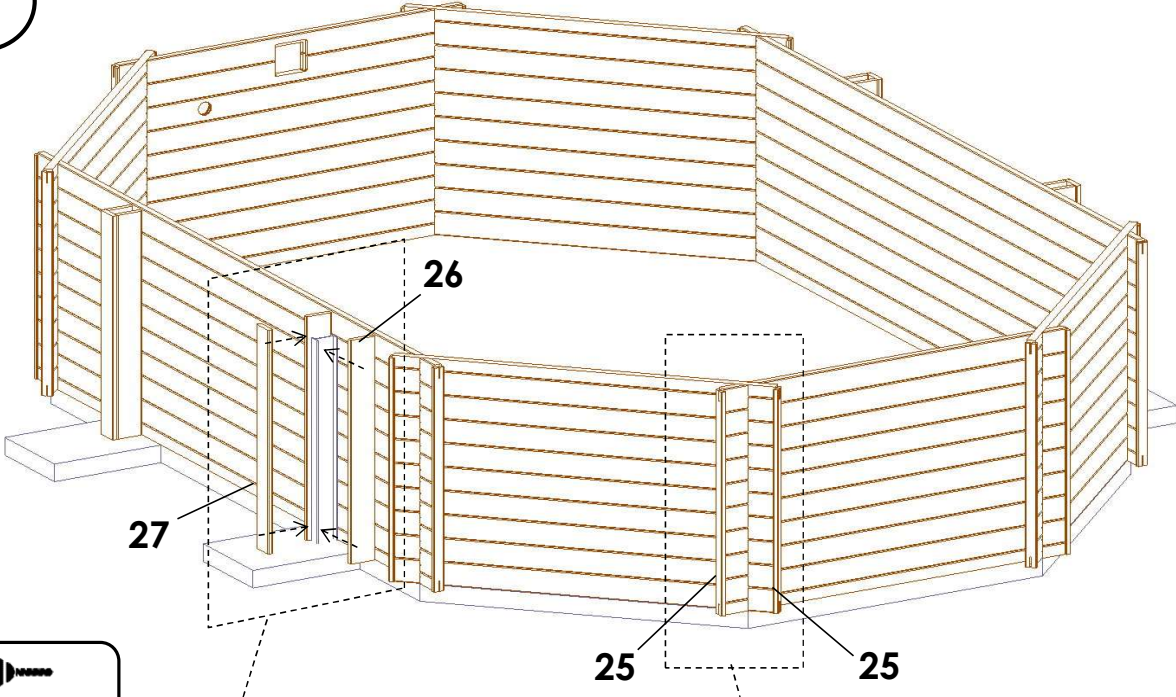

4

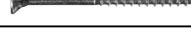

-  Ø5,0x80 (x32)
-  Ø4,5x60 (x24)
-  Ø5,0x100 (x16)

5

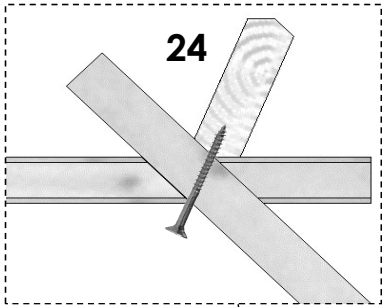

24

Ø5,0x100 (x2)

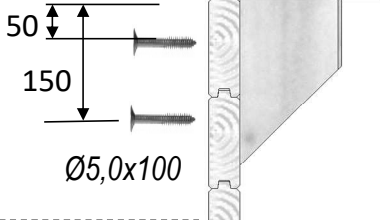
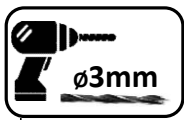

50

150

Ø5,0x100

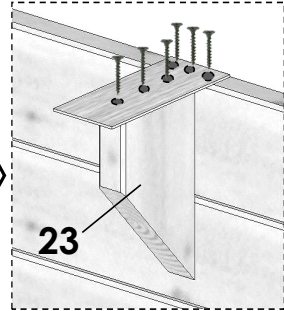

23

Ø3,5x25 (x6)

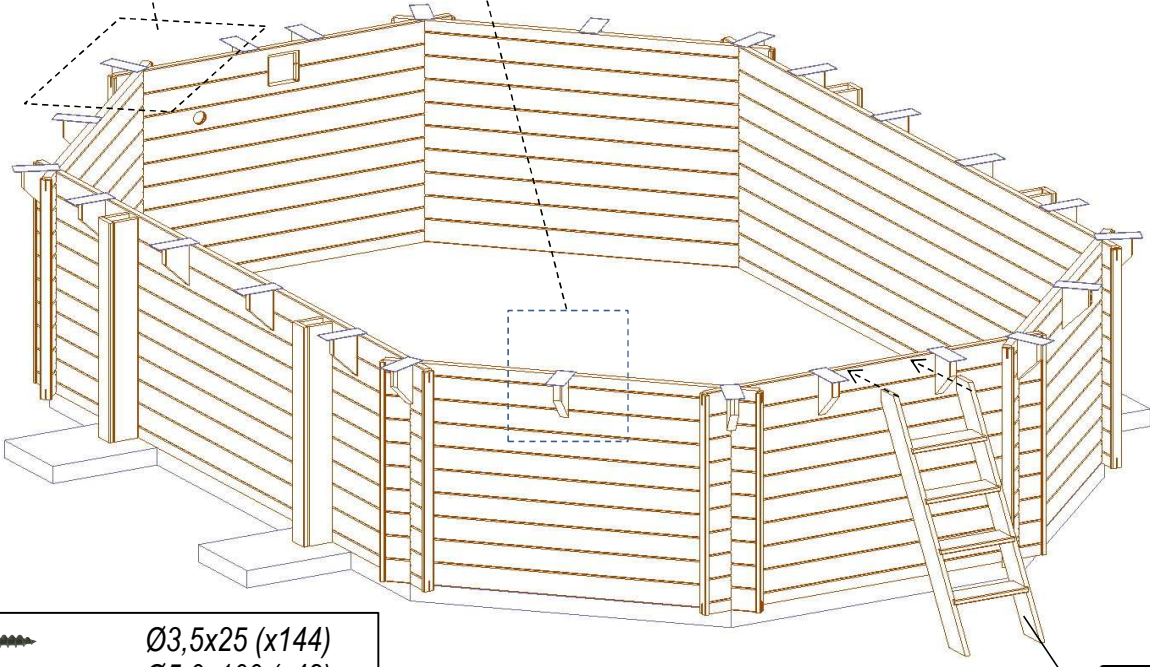

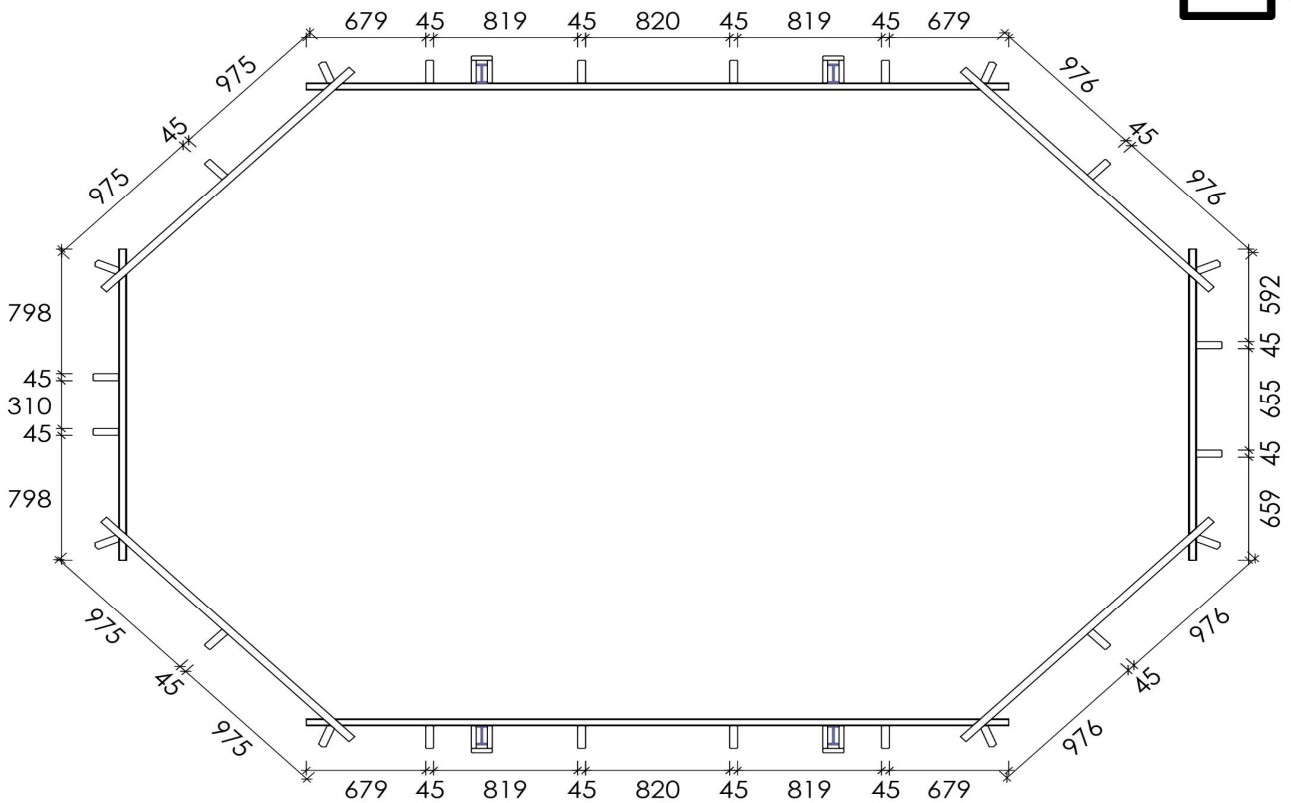

- Ø3,5x25 (x144)
- Ø5,0x100 (x48)



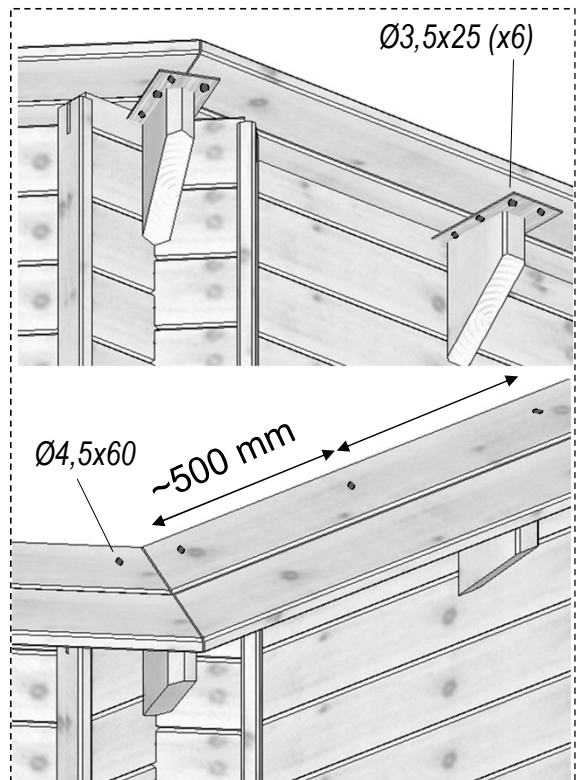
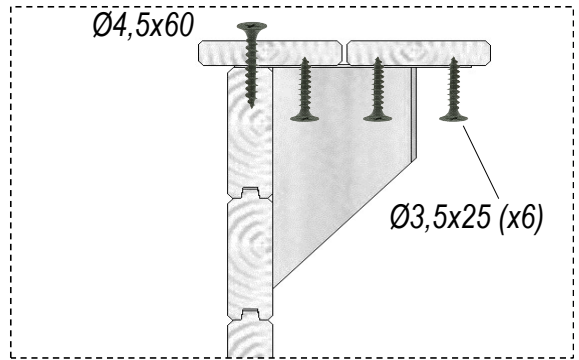
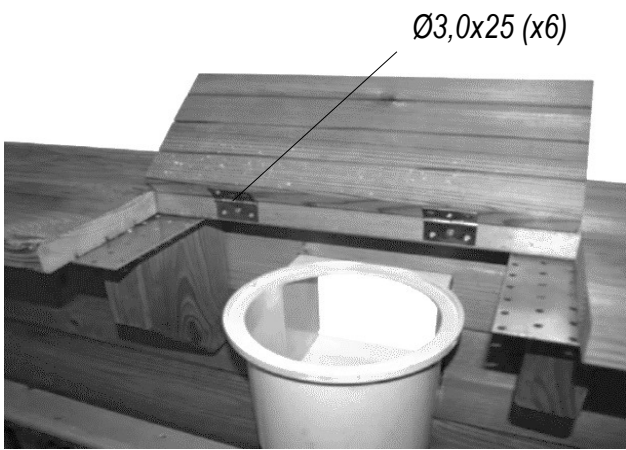
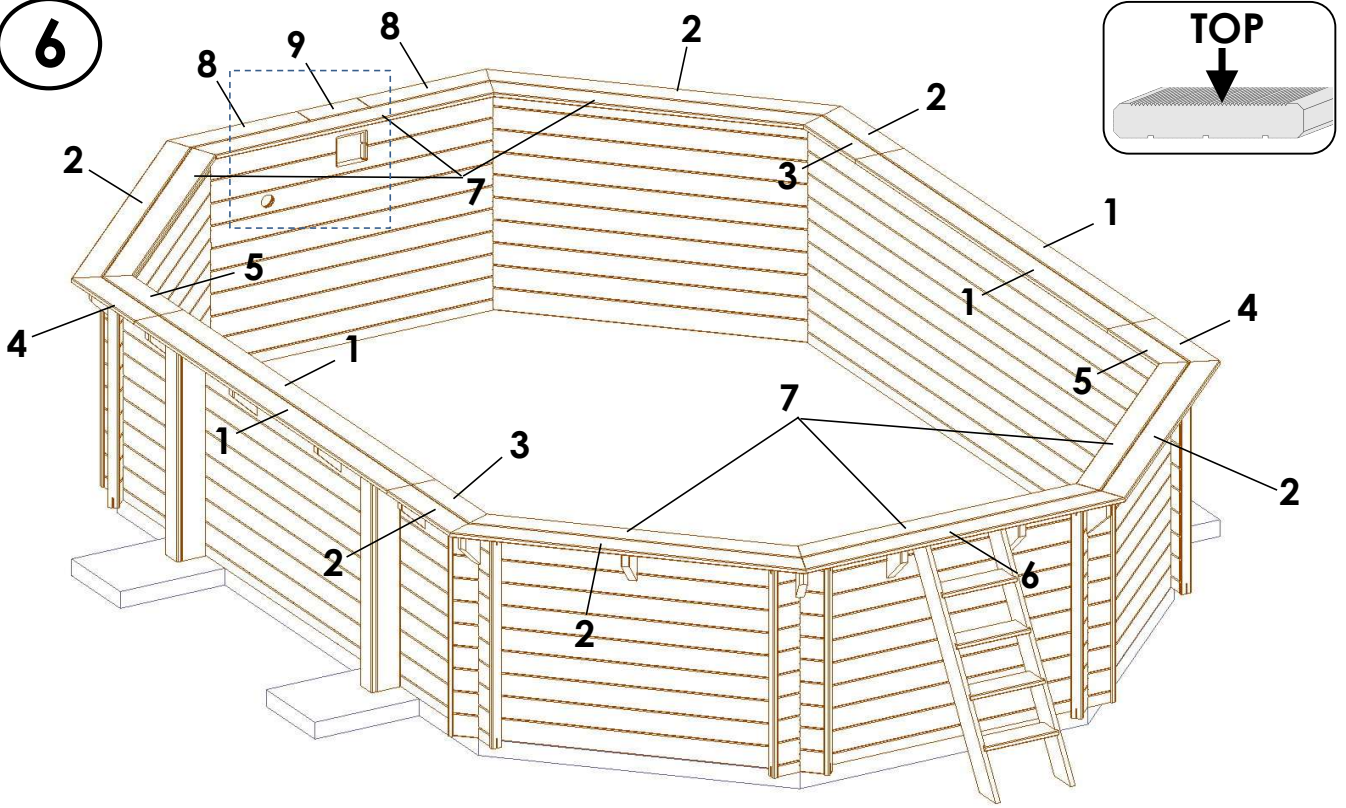

6

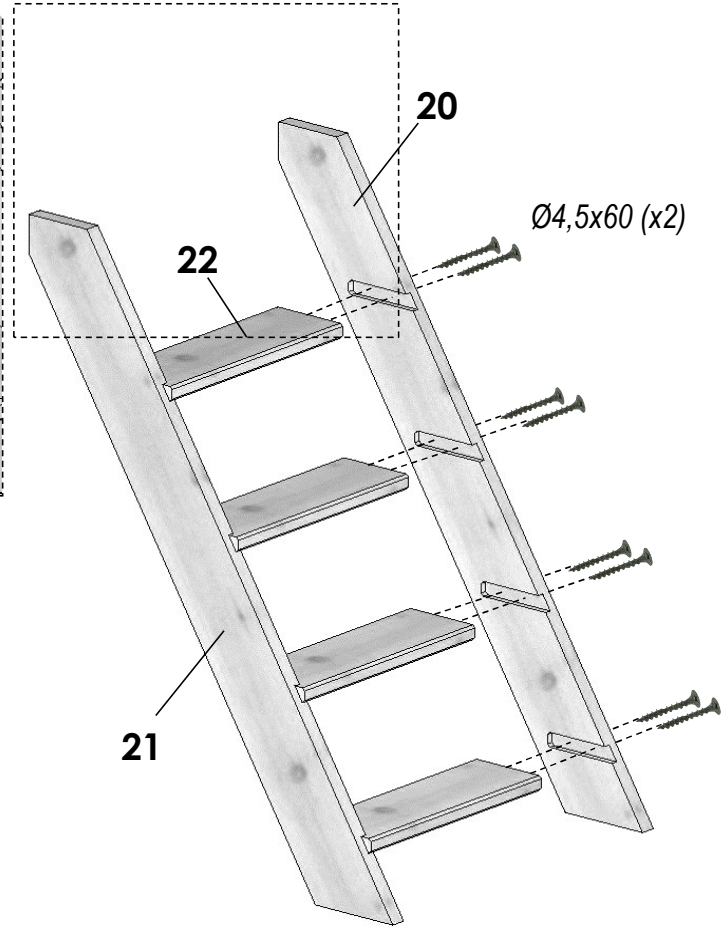
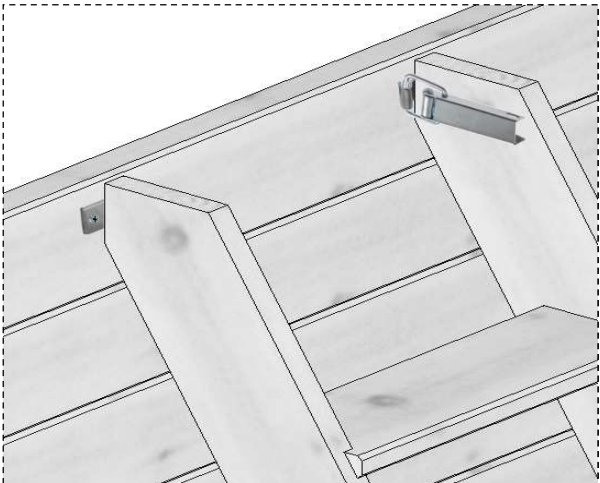
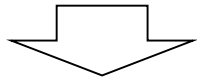
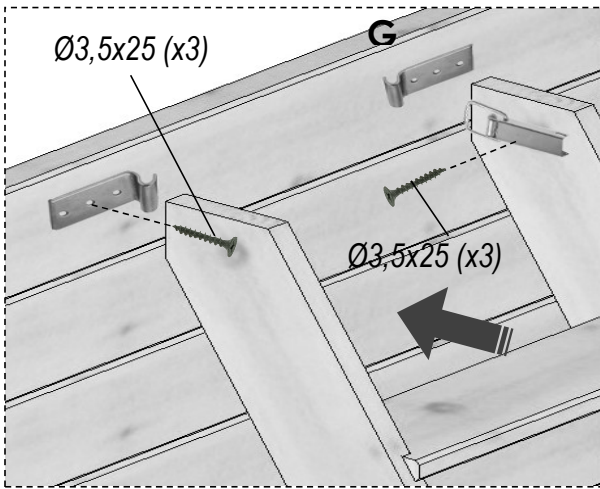

-  Ø3,0x25 (x12)
-  Ø3,5x25 (x144)
-  Ø4,5x60 (x44)



	$\text{Ø}3,5 \times 25$ - x12
	$\text{Ø}4,5 \times 60$ - x16