

heckBOXX flex

Multivan/California Beach T5 / T6 / T6.1
750/850mm



BUSBOXX

Hinweise

Bei Rückfragen:

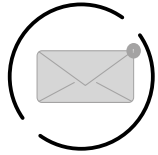

reklamation@bus-boxx.de

Beladehinweise:

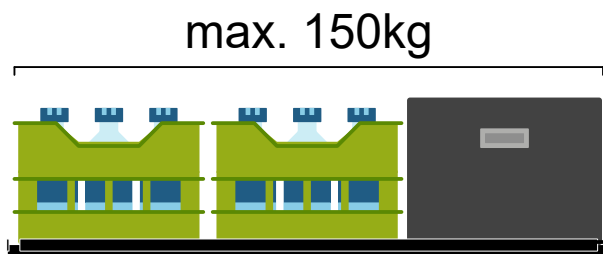

Belade deine heckBOXX flächig maximal mit 150kg.



Achte das die Last gleichmäßig auf deiner heckBOXX verteilt ist.

Dieses Werkzeug benötigst du

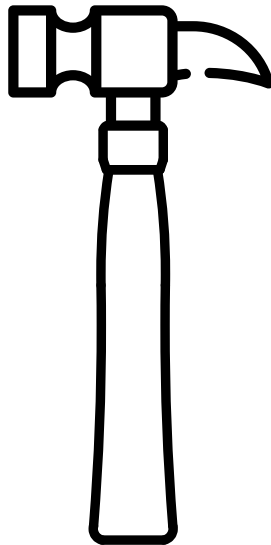

Teilebezeichnung

- BB-1183: Zylinderkopfschraube 6x10
- BB-1439: Hülsenmutter SW5/M6
- BB-1174: Holzdübel 10x35
- BB-1629: Sterngriff M8
- BB-1639: Scheibe 8,4
- BB-1646: T-Screw M8x67mm
- BB-2290: Satz Schwerlastauszug 711mm flex
- BB-1040: Einweg-Sechskantschlüssel L-Form SW4
- BB-1057: Einweg-Sechskantschlüssel L-Form SW5
- BB-1930: Grundplattform
- BBE-1875: Anbauteil auf 750
- BBE-1880: Anbauteil auf 800
- BBE-1885: Anbauteil auf 850
- BBE-1890: Anbauteil auf 900
- BBE-1895: Anbauteil auf 950

Stückliste

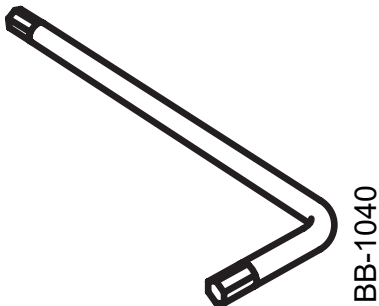
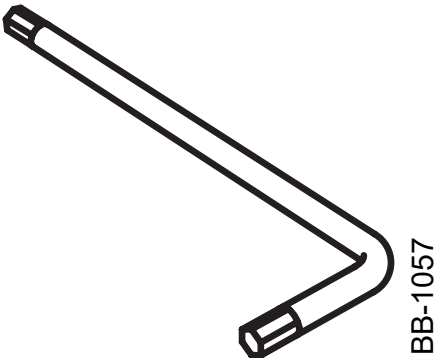
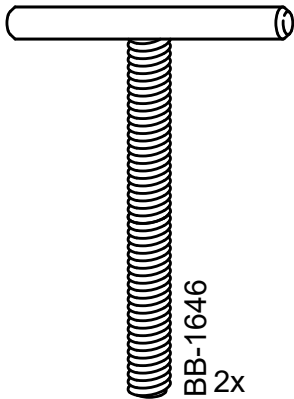
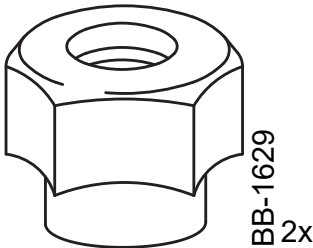
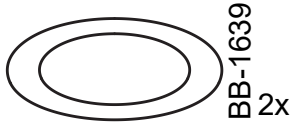
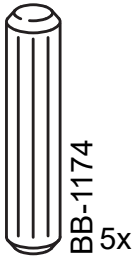
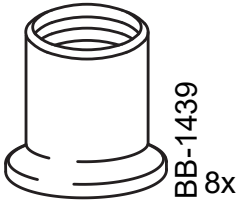
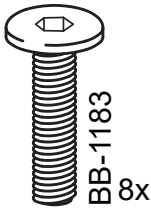

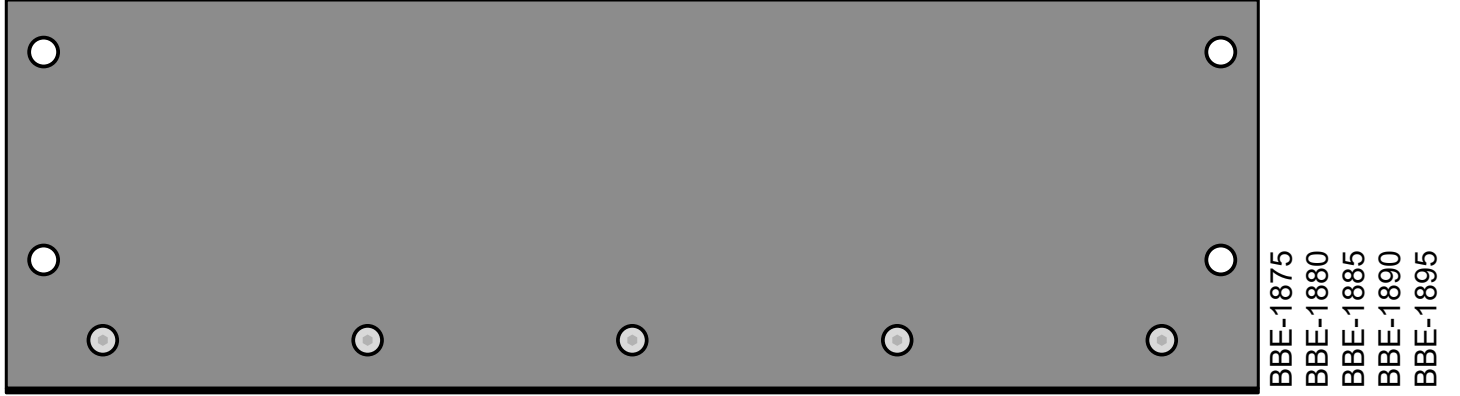
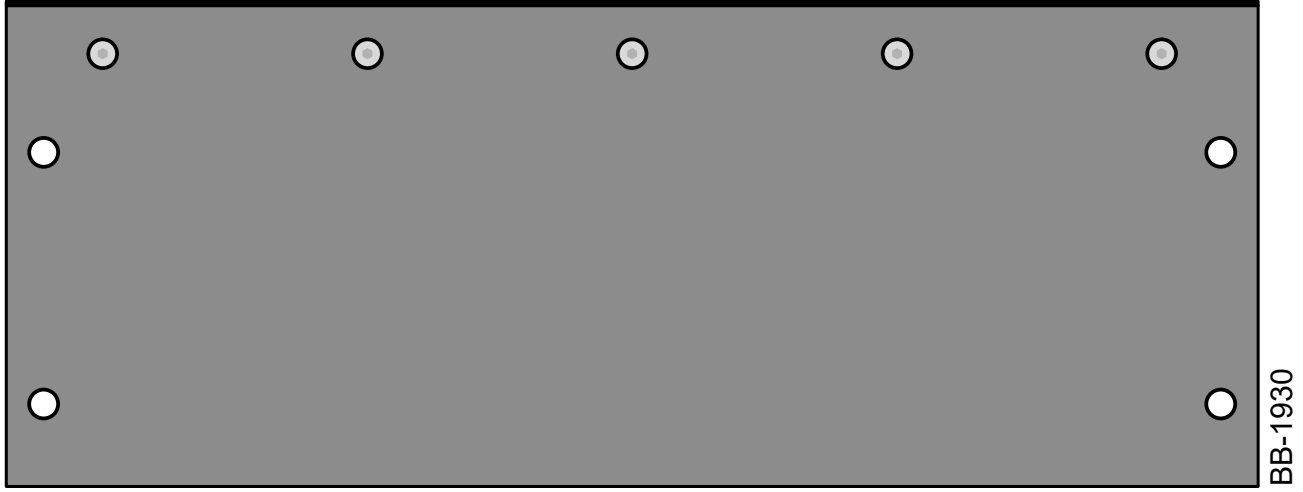
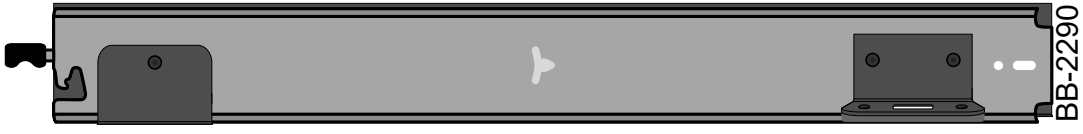

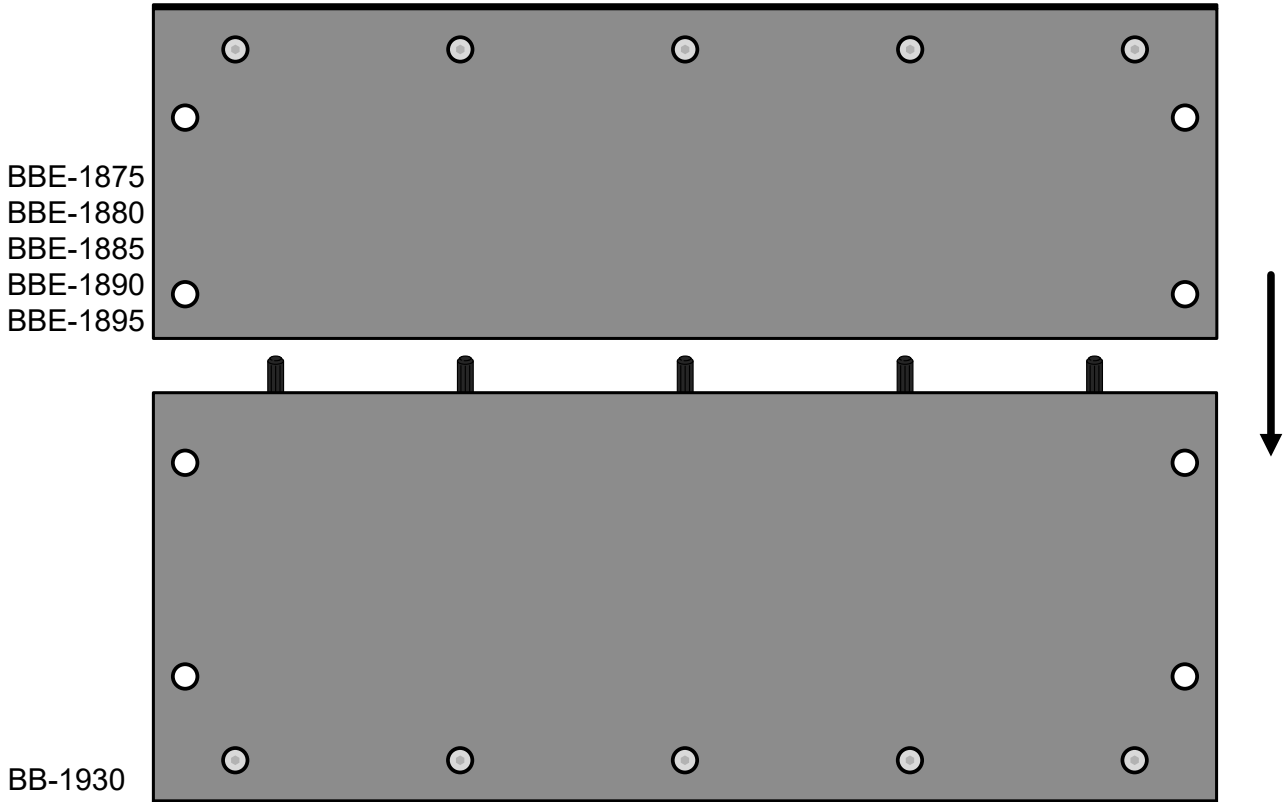
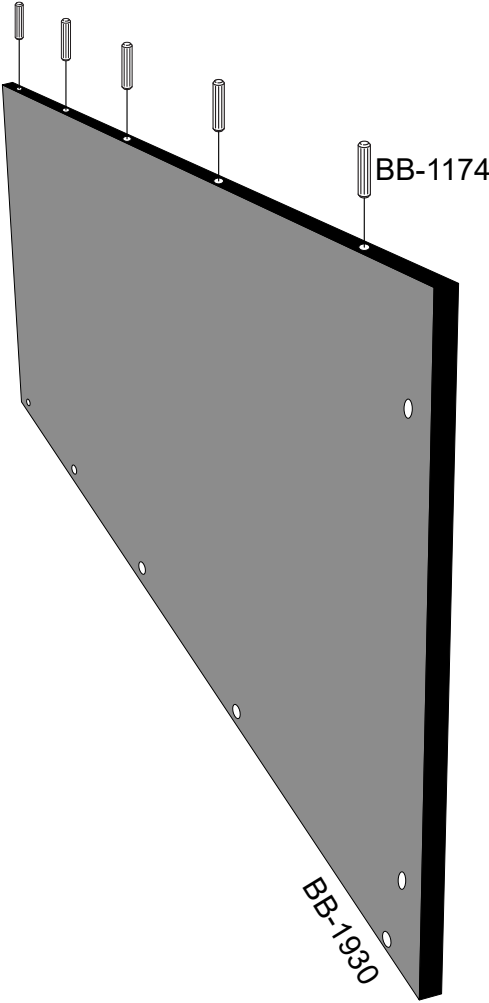

Montage

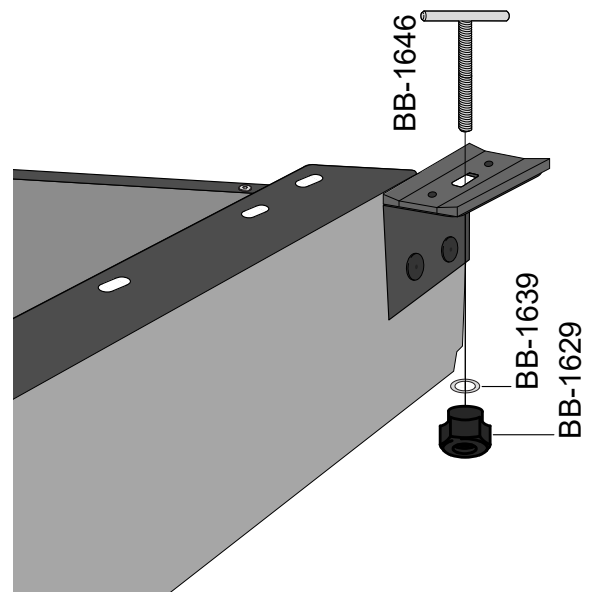
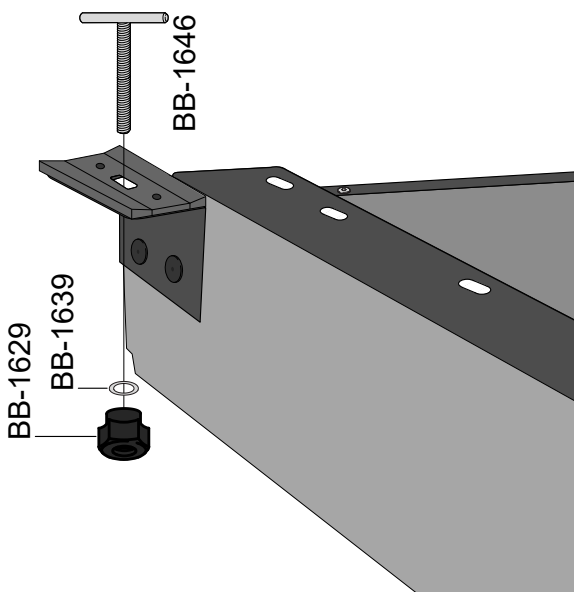
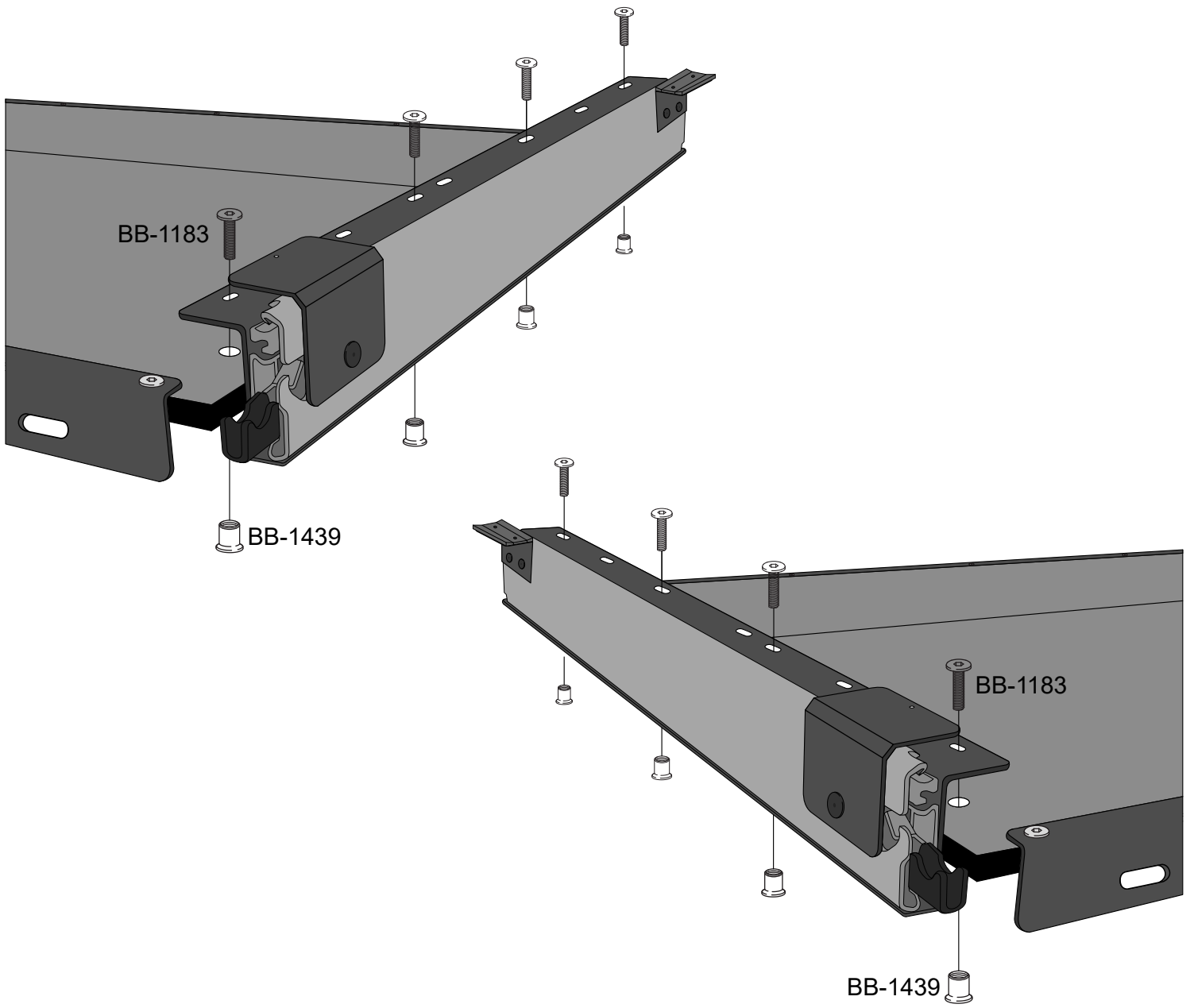



www.bus-boxx.de
reklamation@bus-boxx.de

BUS-BOXX GmbH & Co.KG Gundelsheimerstraße 65 96052 Bamberg

 @BUS-BOXX  @BUSBOXX  @BUS-BOXX