

# heckBOXX diy Starter

VW T5/T6/T6.1 Transporter/Caravelle

Auszugslänge 1520mm



- Plattform im Lieferumfang nicht enthalten. -

# Hinweise

Bei Rückfragen:



[reklamation@bus-boxx.de](mailto:reklamation@bus-boxx.de)

Beladehinweise:

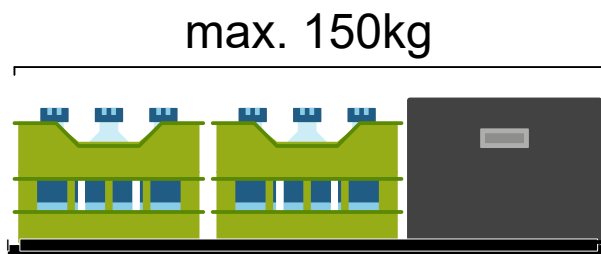

Belade deine heckBOXX flächig maximal mit 150kg.

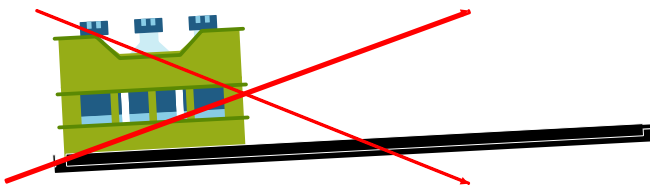

Achte das die Last gleichmäßig auf deiner heckBOXX verteilt ist.

# Dieses Werkzeug benötigst du

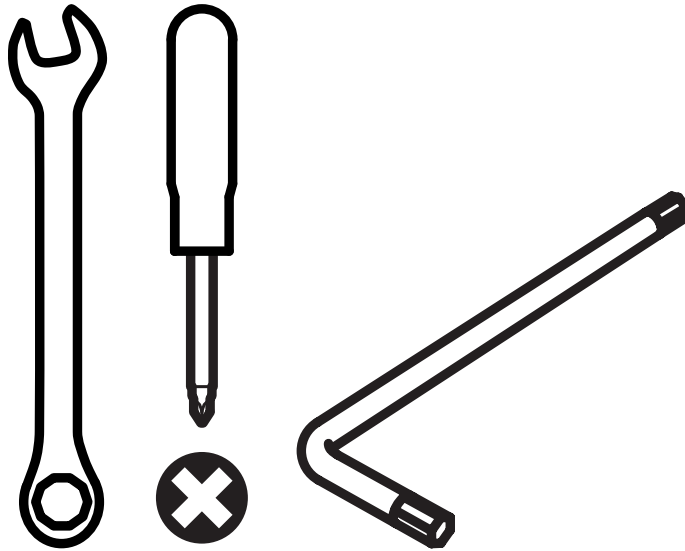

## Stückliste

### Befestigungsmaterial im VW Transporter

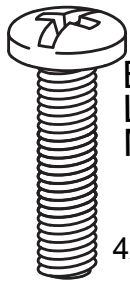

BB-1612  
Linsenkopfschraube  
M10x45

4x

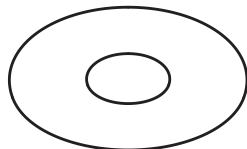

BB-2093  
Kotflügelscheibe  
10,5x40x2

4x

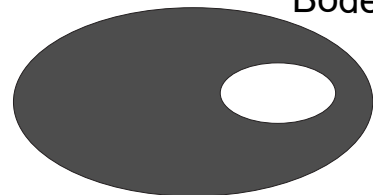

BB-1809  
Abdeckplatte  
Boden

4x

### 12x Befestigungsmaterial Bodenwinkel Auszug

### 12x Befestigungsmaterial L-Winkel Auszug

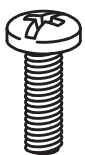

BB-1087  
Linsenkopfschraube  
M5x12

24x

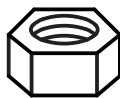

BB-1714  
Sechskantmutter  
M5

24x



BB-1740  
Scheibe  
5,3

24x

# Stückliste

**8x Befestigungsmaterial für die Aufkantung vorne und hinten**

**8x Befestigungsmaterial für die Plattform - 4 je Seite**

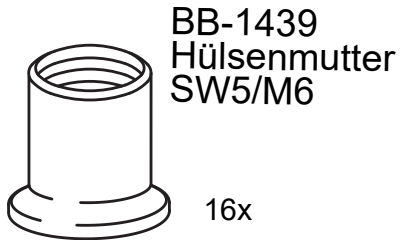

16x



16x



## Beladehinweis

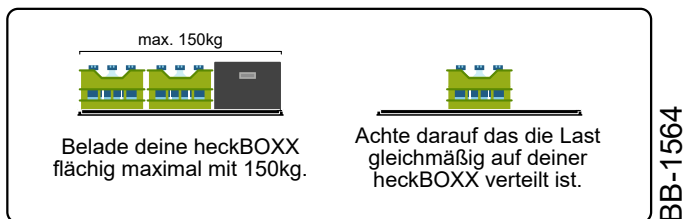

## DIY Aufkleber



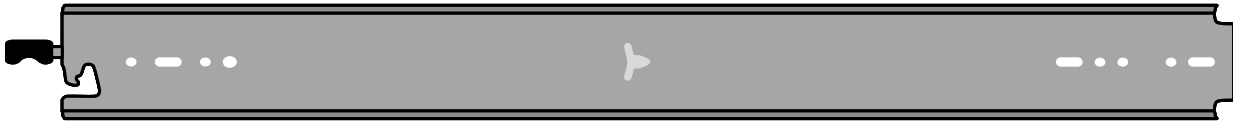

BB-1020: Vollauszug 1524mm 2x

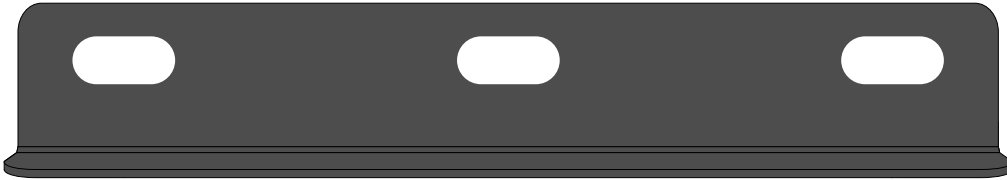

BB-1557 Aufkantung Vorne/Hinten 900 2x



BB-1690 Befestigungswinkel rechts



BB-1690 Befestigungswinkel links



BB-1573 Halteblech rechts



BB-1574 Halteblech links

# Montage

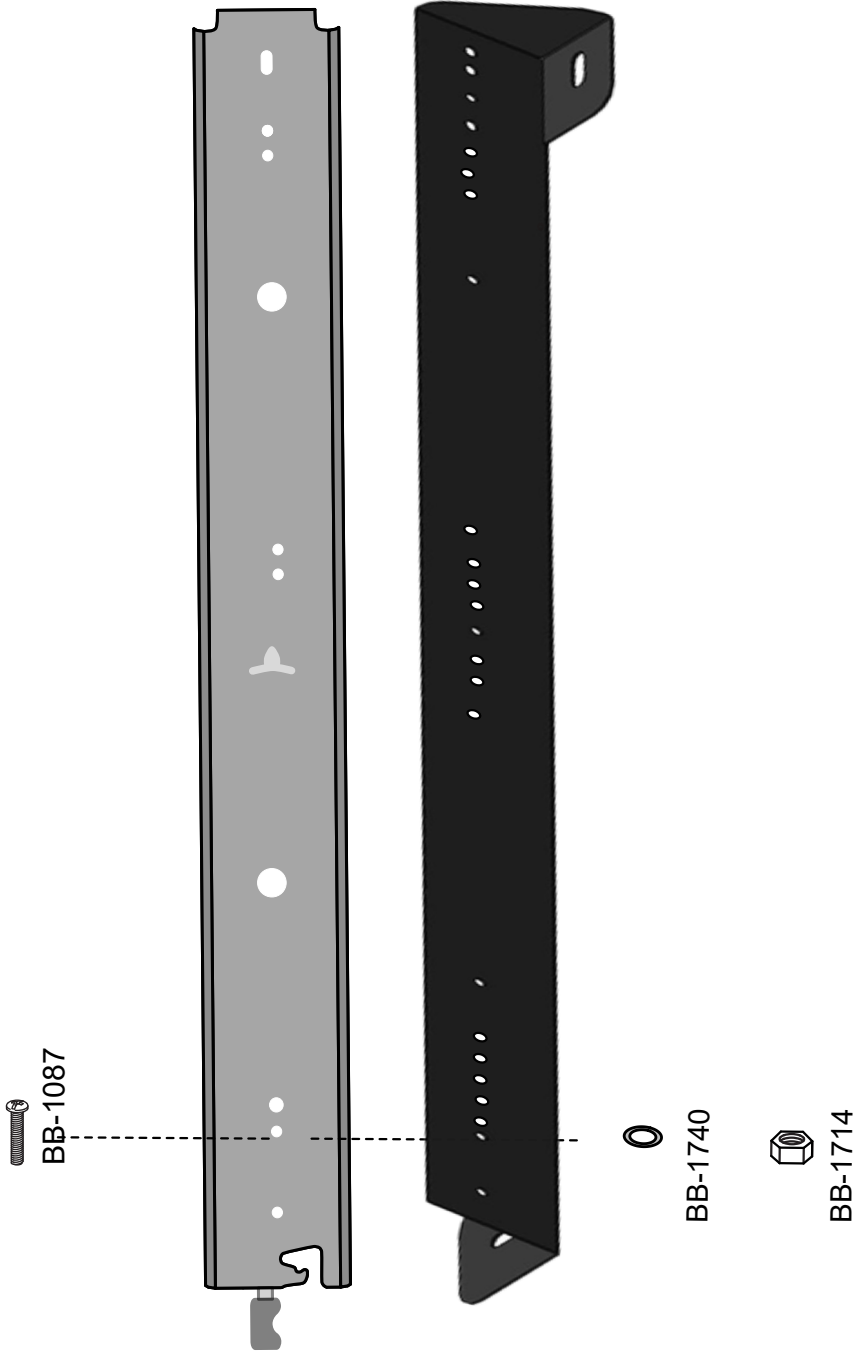

BB-1020

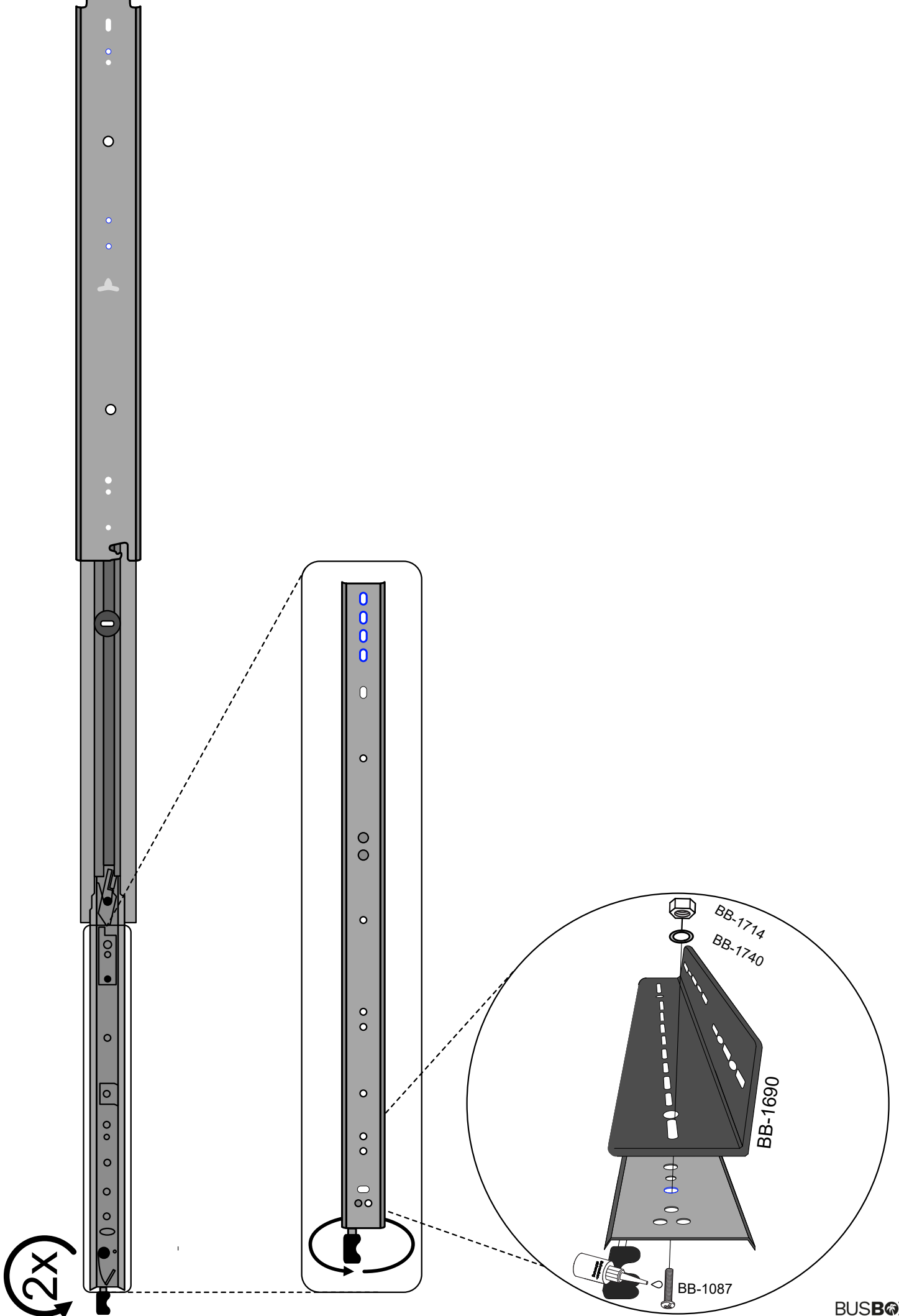

## Beispiel für Montage mit beliebiger Platte

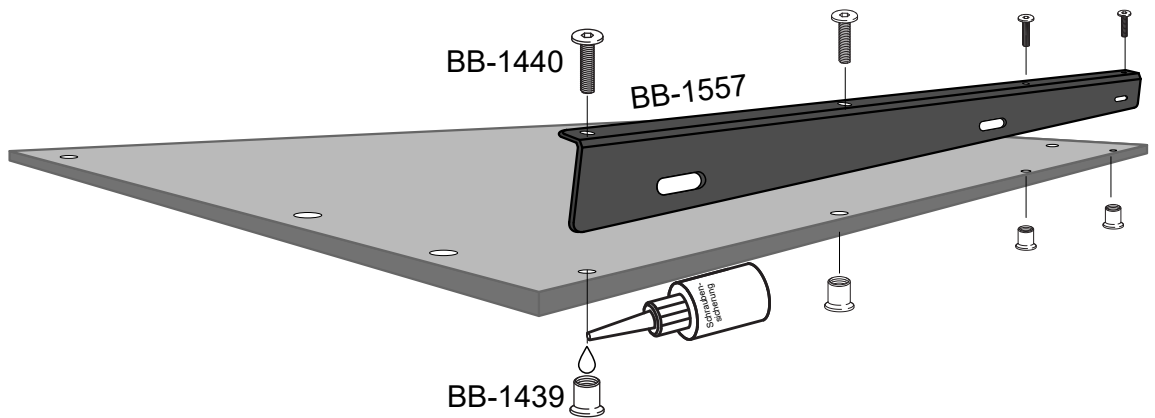
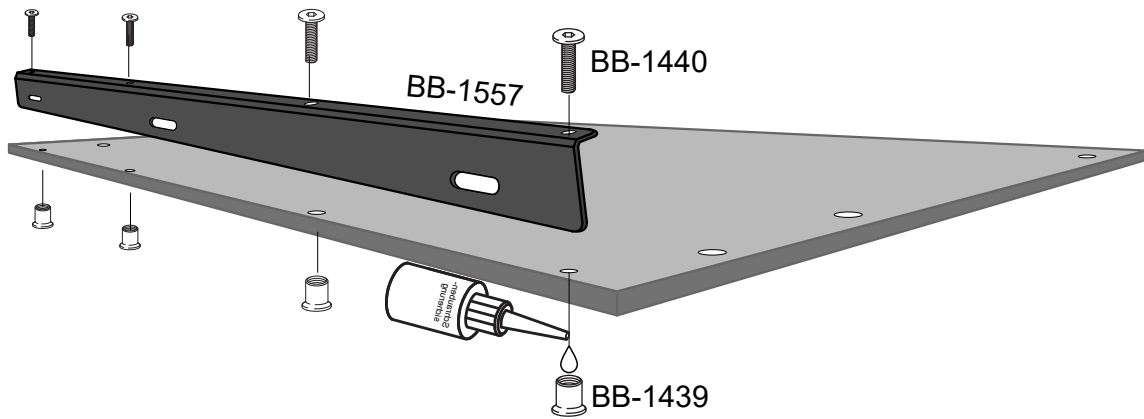

BUS-BOXX GmbH & Co.KG Gundelsheimerstraße 65 96052 Bamberg



@BUS-BOXX



@BUSBOXX



@BUS-BOXX

Alle Angaben ohne Gewähr. Bilder können Sonderausstattung gegen Mehrpreis zeigen. Bilder können gegenüber den Original Produkten abweichen.