

heckBOXX diy Starter

VW T5/T6/T6.1 Transporter/Caravelle

Auszugslänge 1220mm



- Plattform im Lieferumfang nicht enthalten. -

Hinweise

Bei Rückfragen:

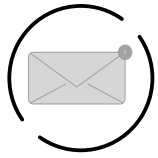

reklamation@bus-boxx.de

Beladehinweise:

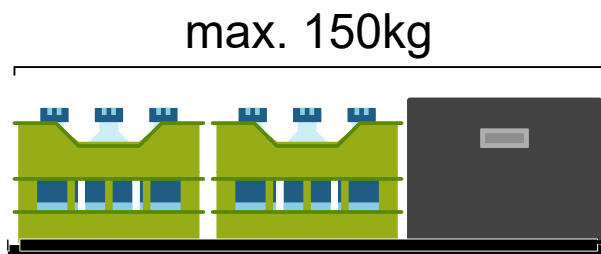

Belade deine heckBOXX flächig maximal mit 150kg.

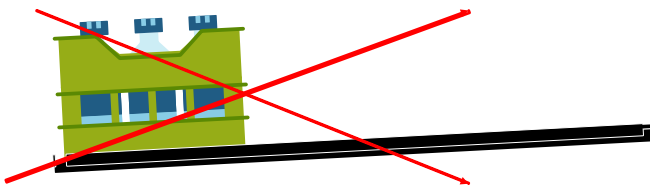

Achte das die Last gleichmäßig auf deiner heckBOXX verteilt ist.

Dieses Werkzeug benötigst du

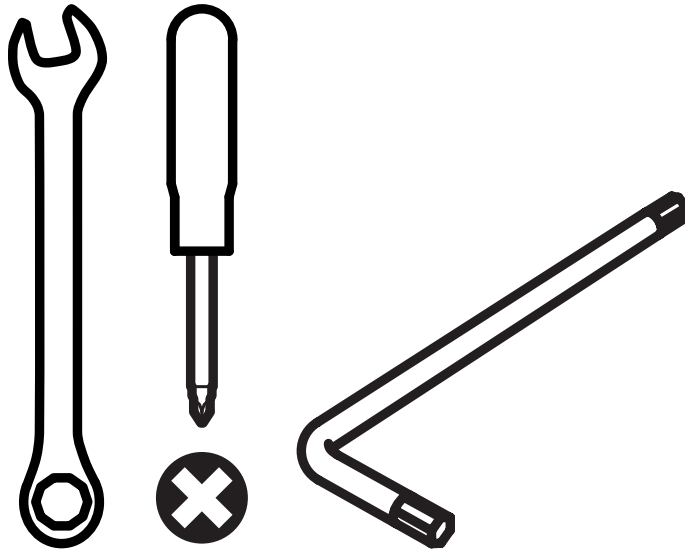

Stückliste

Befestigungsmaterial im VW Transporter

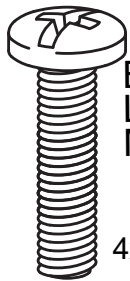

BB-1612
Linsenkopfschraube
M10x45

4x

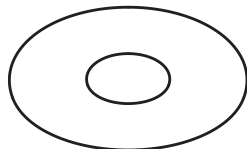

BB-2093
Kotflügelscheibe
10,5x40x2

4x

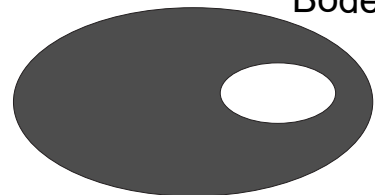

BB-1809
Abdeckplatte
Boden

4x

12x Befestigungsmaterial Bodenwinkel Auszug

12x Befestigungsmaterial L-Winkel Auszug

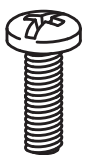

BB-1087
Linsenkopfschraube
M5x12

24x

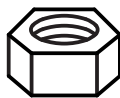

BB-1714
Sechskantmutter
M5

24x



BB-1740
Scheibe
5,3

24x

Stückliste

8x Befestigungsmaterial für die Aufkantung vorne und hinten

8x Befestigungsmaterial für die Plattform - 4 je Seite

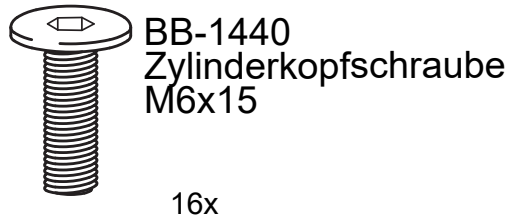
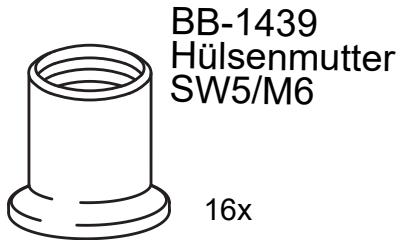

Beladehinweis

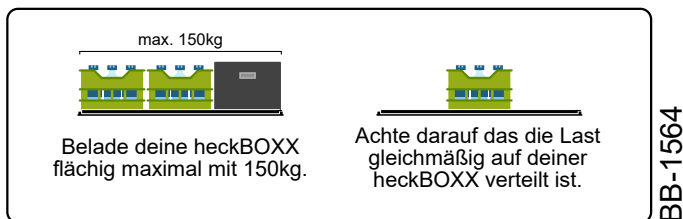

DIY Aufkleber



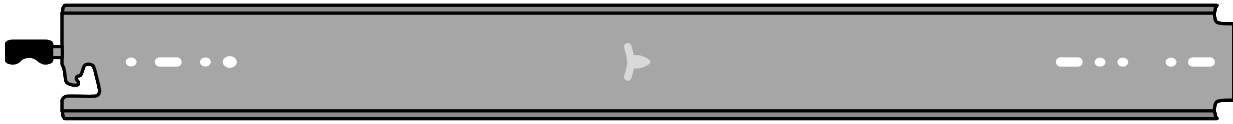

BB-1543: Vollauszug 1219,2mm 2x

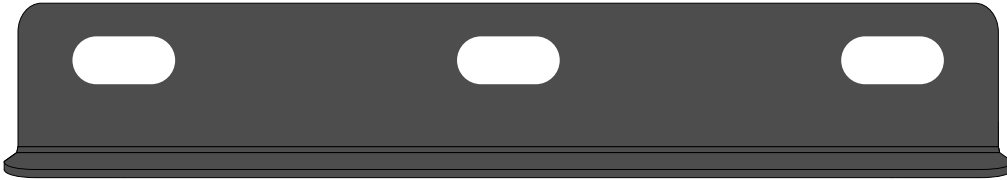

BB-1557 Aufkantung Vorne/Hinten 900 2x



BB-1690 Befestigungswinkel rechts



BB-1690 Befestigungswinkel links



BB-1573 Halteblech rechts



BB-1574 Halteblech links

Montage

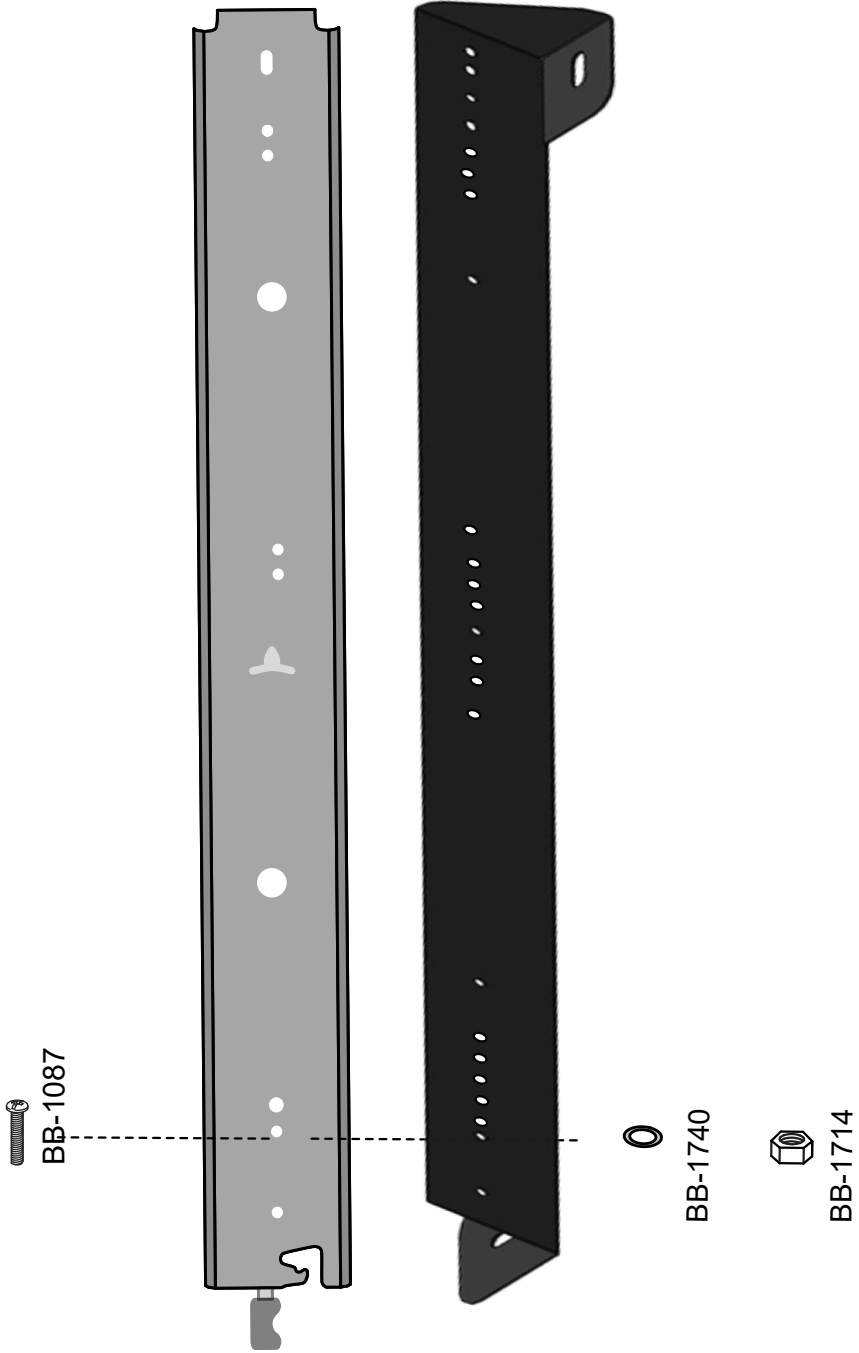

BB-1543

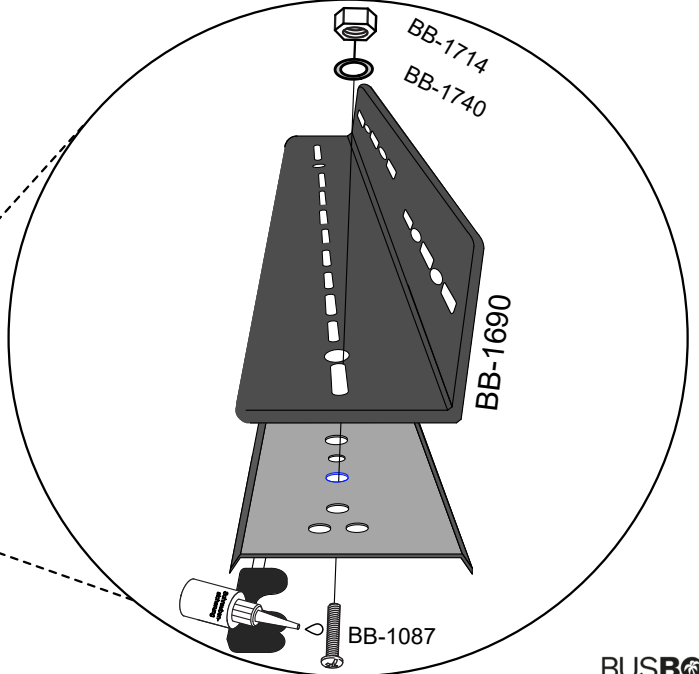
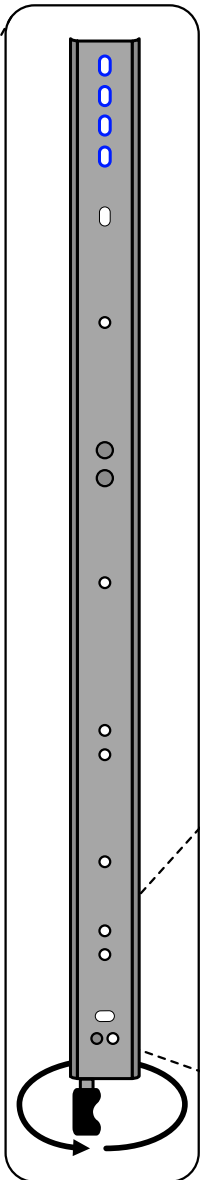
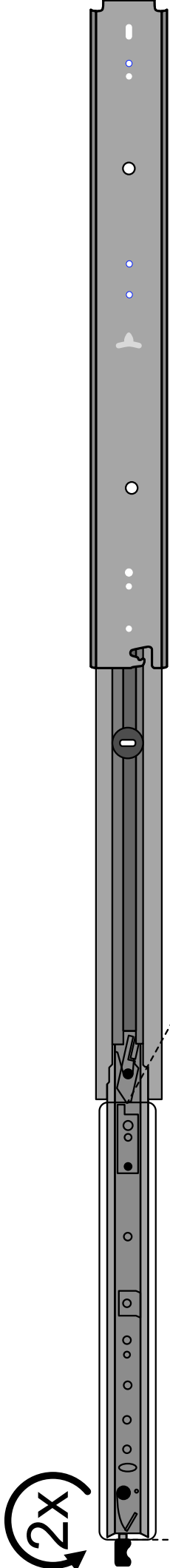

Beispiel für Montage mit beliebiger Platte

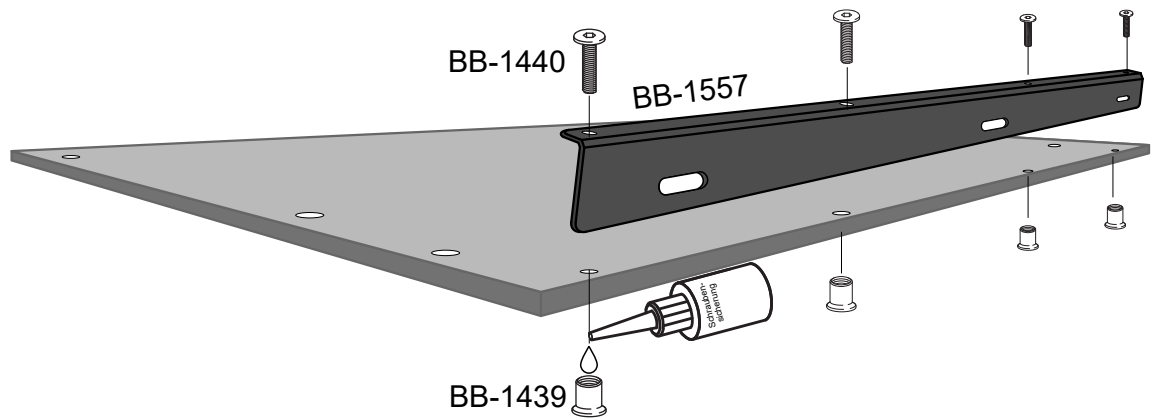
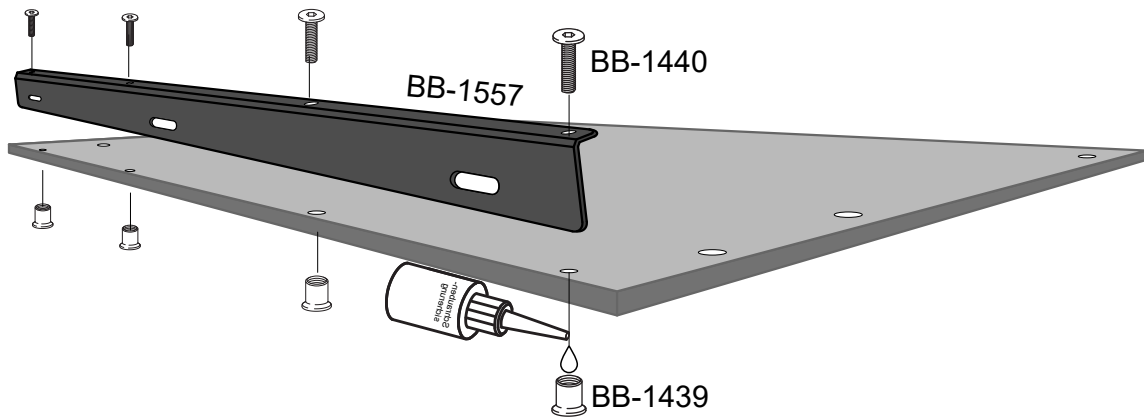

BUS-BOXX GmbH & Co.KG Gundelsheimerstraße 65 96052 Bamberg



@BUS-BOXX



@BUSBOXX



@BUS-BOXX

Alle Angaben ohne Gewähr. Bilder können Sonderausstattung gegen Mehrpreis zeigen. Bilder können gegenüber den Original Produkten abweichen.