

Horizon

BINDING

iCE BINDER BQ-500

Next Generation
Perfect Binder

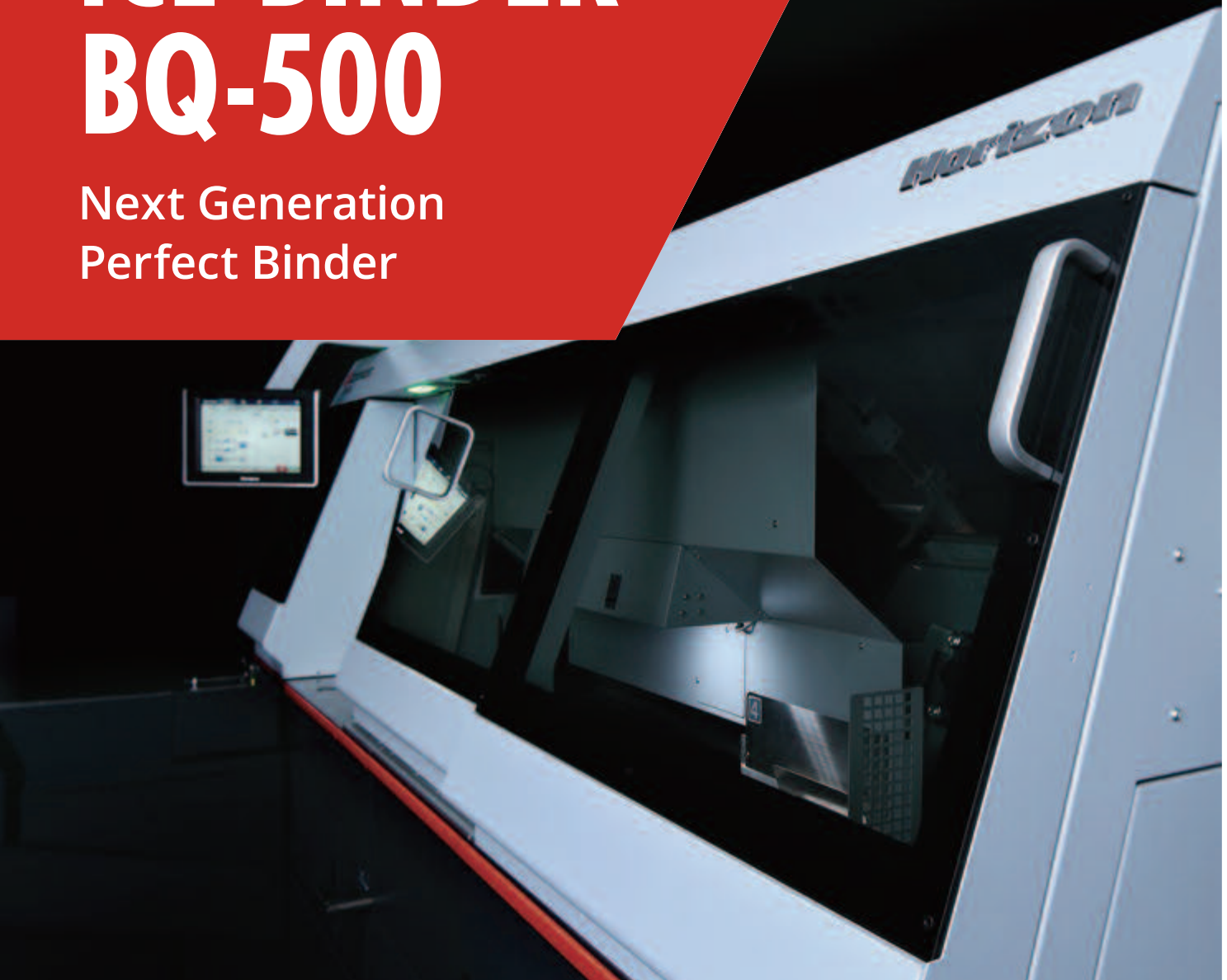



i = Intelligence, Integration, Interaction
 C = Connection
 E = Efficiency

All Connected...

Optimize the finishing process with automation and workflow.

The iCE series is a new product line-up which is designed to provide added value to our customers. A new operator interface for a more intuitive operation, and advanced automation to provide increased efficiency and productivity. In addition, connecting with an iCE LiNK workflow system provides an advanced and totally connected work environment.

NEXT GENERATION BOOK BINDER WITH CONNECTED FEATURES.

New level of automation brings binding quality to the next level.



iCE TRIMMER HT-300
Three-side Trimmer

iCE BINDER BQ-500
Perfect Binder

FEATURE

HIGH PRODUCTIVITY

The BQ-500 excels at and is the most productive binder for book-of-one production. In addition, productivity is increased on longer runs with decreased set-up time and improved system efficiencies.

HIGH QUALITY

A uniquely designed template feature produces high quality books even with a non-skilled operator. Knowledge from a skilled operator can be stored in custom templates to produce consistent high quality books by any operator.

EVA & PUR

The BQ-500 supports both EVA and PUR hotmelt glue. Two different tanks are available and interchangeable for each glue type.

CONFIGURATION FLEXIBILITY

The system can be connected with various options to extend capabilities. A cover slitting unit, cover reject unit, elevator unit, glued book block feeder, loose sheet book block feeder, and in-line three knife trimmer are all available options with the BQ-500.

MANAGE YOUR BINDERY WITH HORIZON'S BINDERY CONTROL SYSTEM

The iCE Series can be enhanced with automated workflow from upstream to postpress with iCE LiNK, which uses cloud technology, and is Horizon's next generation bindery control system.

Scan QR code and watch the product video.



DETAILED PROCESS FEATURES.

Exclusive new features for improved production and quality.

1 TOUCH PANEL DISPLAY



The 12.1 inch color touch-screen is icon-based for user-friendly operation. Setup, operation and fine tuning can be done at the touchscreen. Ergonomically designed slide operator console for operation efficiency, with loading and operation from either the left or right side.

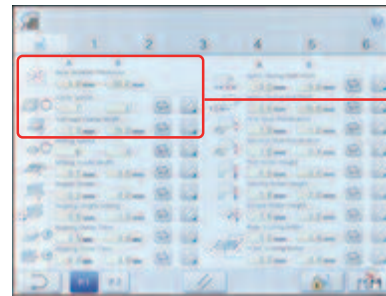

Customized templates can be created according to desired book quality, paper type and other factors. These customized templates can be created by a key operator or manager who controls the quality. Once a template is created, the operator just selects the desired template to setup the system. This enables any operator to produce consistent quality books with improved production efficiency and greater quality control.

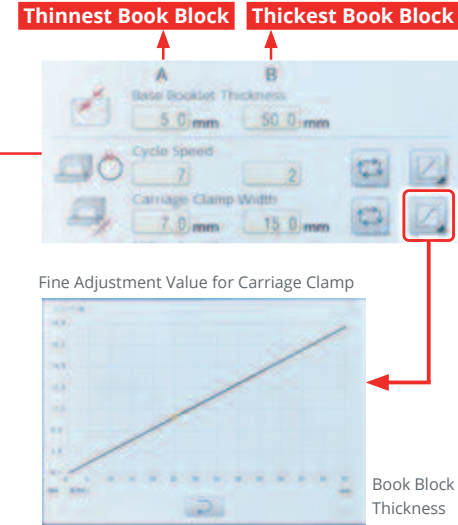

To create a template, set-up for the thinnest book and thickest book and it automatically calculates the value in between.



2 BOOK FEEDING SECTION

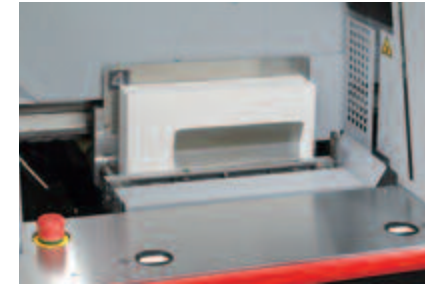

A rigid clamping system holds the book block firmly in position during the milling and nipping process to produce a quality finished book. The safety curtain ensures risk-free operation.

3 MILLING SECTION



Powerful servo motor driven milling and notching mechanism mills the spine of the book block or signatures for optimum glue penetration and adhesion. Milling rotation speed can be adjusted automatically according to book thickness and custom template. Milling depth can be adjusted from 0 to 4 mm or 0" to 0.157".

4 GLUE TANK SECTION



Dual application rollers and side gluing rollers ensure superior glue application to the spine and excellent adhesion of the cover for consistent quality binding. Glue roller height, wiper opening and cut-off timing, scraper roller height, and side glue roller width are automated.

5 NIPPING SECTION



A strong rigid nipping mechanism and positive jogging guarantees precise alignment of the cover to the book block and square spines. Nipping width, height, operating time and delay time are adjusted automatically according to book thickness.

6 COVER REGISTRATION SECTION



After transport to the nipping section, the cover is registered precisely with the fore-edge guide and tail-edge positioning guides.

7 SCORING SECTION

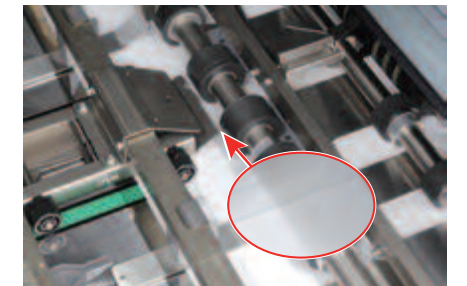

The scoring width and position are automatically set-up according to book block thickness and cover registration. Scoring is performed on thick covers for professional binding with sharp, square spines and hinge scores.

8 COVER FEEDING SECTION



The high capacity cover feed station has a maximum pile height of 150 mm or 5.9" for continuous binding operation. The cover feeder can handle a wide range of covers: Bond Paper 81.4 to 302.4 gsm and Coated Paper 104.7 to 348.9 gsm.

9 BOOK DELIVERY SECTION



Uniquely designed delivery eliminates damage to the spine. Even 65 mm or 2.56" thick books or PUR bound books can be delivered without damage or marking.

OPTIONS.

Automated Book Block Feeding System For the BQ-500.

FEATURES OF EL-480 + BBF-480

HIGH PRODUCTIVITY

Book blocks are fed automatically at high speed. The maximum speed is 1,000 book blocks per hour.

EFFICIENT AND HIGH SECURITY PRODUCTION

This system features various functions for efficient and high security production.

- Book thickness caliper is equipped to setup the binder.
- Optional book block and cover matching system is available.
- Optional cover reject function is available to reject mis-matched covers.

USE OFFLINE

The system can be converted to an offline manual feeding system. Uniquely designed bridge conveyor and slide track enables quick and easy change over from an inline to offline system.

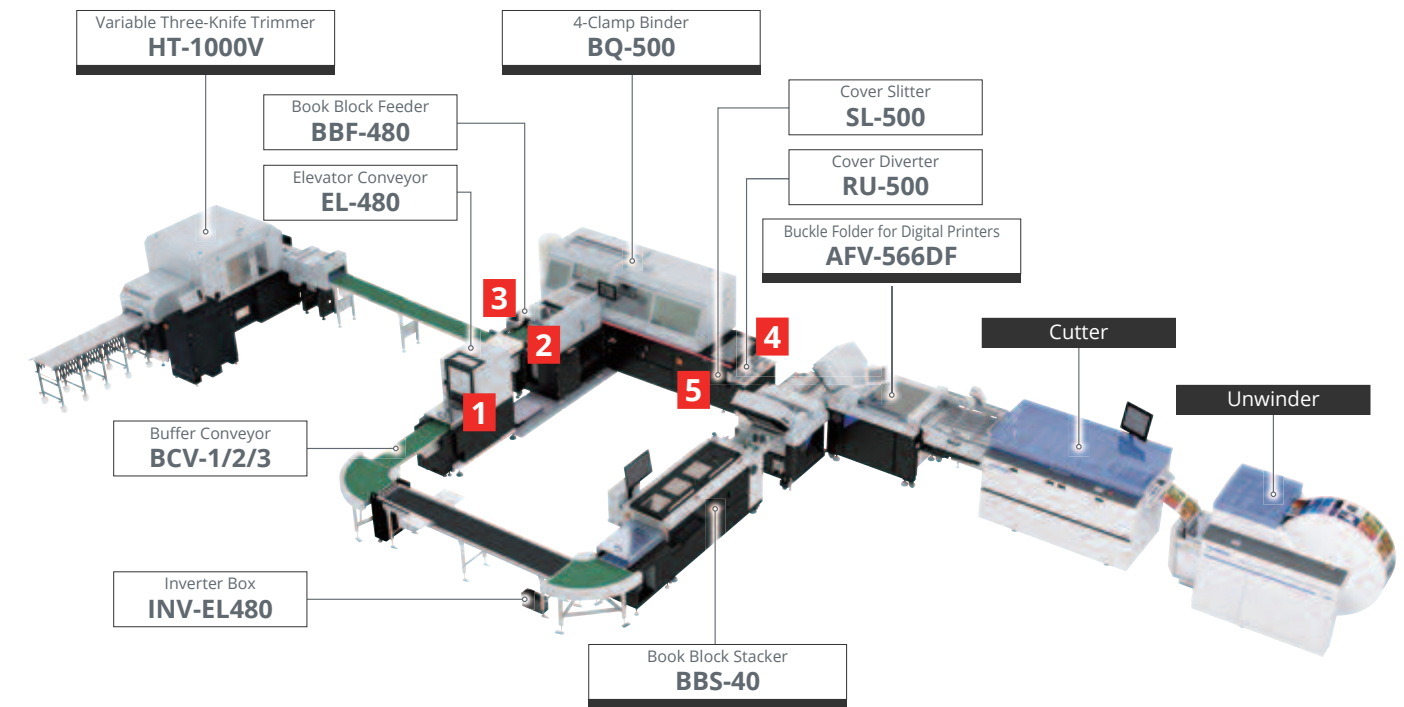

1 EL-480 ELEVATOR CONVEYOR



This system elevates the book block from upstream conveying to the infeed height of the BBF-480.

2 BOOK BLOCK THICKNESS CALIPER / BARCODE READER Option

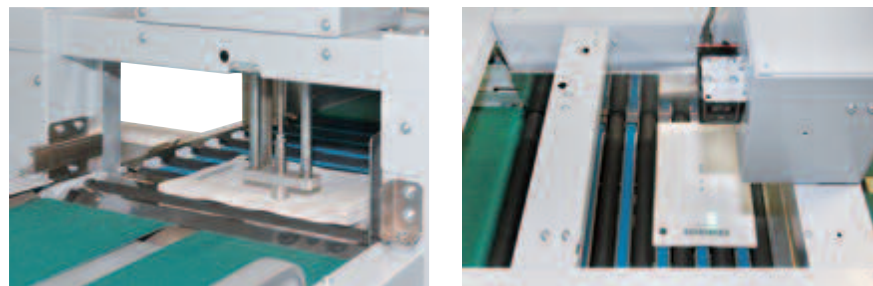

The book block thickness caliper is equipped on the BBF-480. This caliper measures the thickness of the book block accurately for automatic setup of the BQ-500 perfect binder. Optional barcode reader BC-BBF480 is available to match book block and cover for higher security production. The BC-BBF480 is also capable of comparing the actual book block thickness measured at the caliper to that in the data, if provided via barcode.

3 INFED SECTION



Uniquely designed feeding mechanism enables feeding and registering of variable thickness book blocks automatically.

Option for BQ-500

4 COVER REJECT SECTION (RU-500 COVER DIVERTER)



Optional cover reject device is available to reject the cover in case the cover does not match the book block.

Option for BQ-500

5 SLITTER UNIT SECTION (SL-500 COVER SLITTER)



Optional cover slitting device to slit both edges of the cover to eliminate cover over hang for easy handling and increased accuracy at the three knife trimmer.

OPTIONS.

Performance Enhancing Options.

MU-500PUR PUR SPINE GLUE TANK

- Polyurethane reactive adhesive suitable for coated stock. Lay-flat binding can be performed.



MU-500EVA EVA SPINE GLUE TANK

- Commonly used for many types of binding. The melted glue can be used repeatedly so there's no need to clean the tank after operation.



MU-500PUR: Cleaning and Replacement



The application drums and back spinner lift and latch to provide easy access for cleaning of the tank.



Install the special drain for glue run-off. The PUR tank and drums are teflon coated so that the remaining glue can be easily peeled off after cooling.



Sliding rail glue tank for easy replacement. Pull out the tank and remove it with the optional lifting trolley.

L-470 MANUAL SIMPLE LIFTER

- The L-470 is a lifting dolly for easy and safe tank replacement.

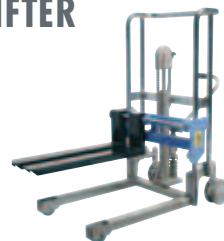

F-470 FORK FOR LIFTER

- The F-470 fork is a custom-fit attachment for the lifter that holds the glue tank firmly in position for easy and safe tank replacement.

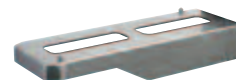

S-470 STAND FOR MELT TANK UNIT

- The S-470 stand is designed to receive and hold the glue tank unit after replacement.



M-470 GLUE MELTING HEATER

- The M-470 is a laboratory oven used to premelt the PUR hotmelt glue.



PM-470 PREMELT TANK (18 LITTER)

- The PM-470 is the premelt tank for EVA hotmelt glue.



B-470 TEFLON COATED BEAKER

- The B-470 teflon coated beaker can be used to premelt the PUR hotmelt glue to refill the glue tank.



CN-480 PRE-MELT TANK CONNECTION KIT

- This is required to connect the PM-470 with the BQ-500.

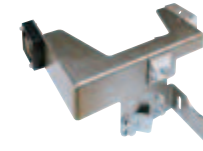

VS-280 SMOKE EXTRACTOR

- This deodorizes the smell of hotmelt glue.



SI-500A BOOK THICKNESS INPUT CALIPER

- The SI-500A is a book thickness measuring and input device for increased operational efficiency.

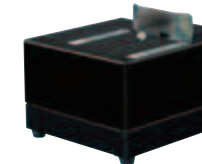

ET-500 EXTRA TABLE

- This table is required to install the SI-500A. You can also use this table as a work table.

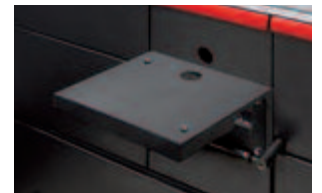

EBT-500 SUPPORT TABLE

- This extends the table on the book block feed section 90 mm or 3.54" to the front.



FLP-480 FLAP COVER KIT

- The fold lines for the flap covers can be scored in-line. The flap covers are folded inward along the scoring lines after binding.

BC-480-1D 1D CODE READER

- This supports both 1D and 2D codes for the book block and only 1D code for the cover sheet.
Code Types:
Barcode CODE39, CODE128, EAN, JAN
2D Code QR Code, Data Matrix

BC-480-2D 2D CODE READER

- This supports both 1D and 2D codes on the both book block and cover sheet.
Code Types:
Barcode CODE39, CODE128, EAN, JAN
2D Code QR Code, Data Matrix

SPECIFICATIONS.

Machine Dimensions. (Unit: mm or inch)

BQ-500 + HT-300

(Top View)

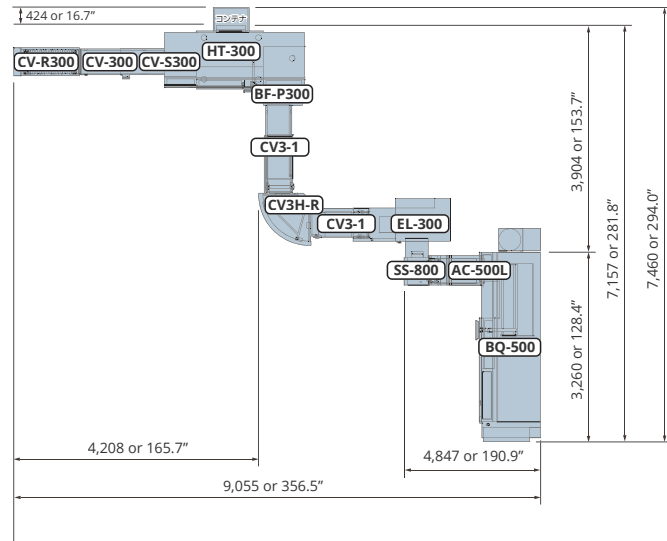

(Top View)

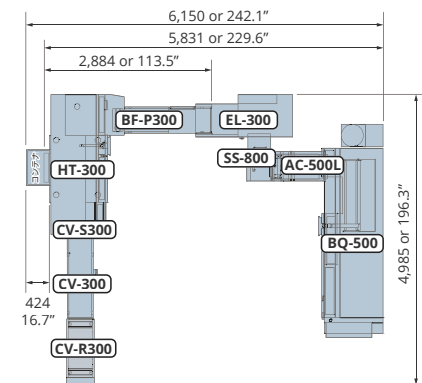

BQ-500 + HT-1000V

(Top View)

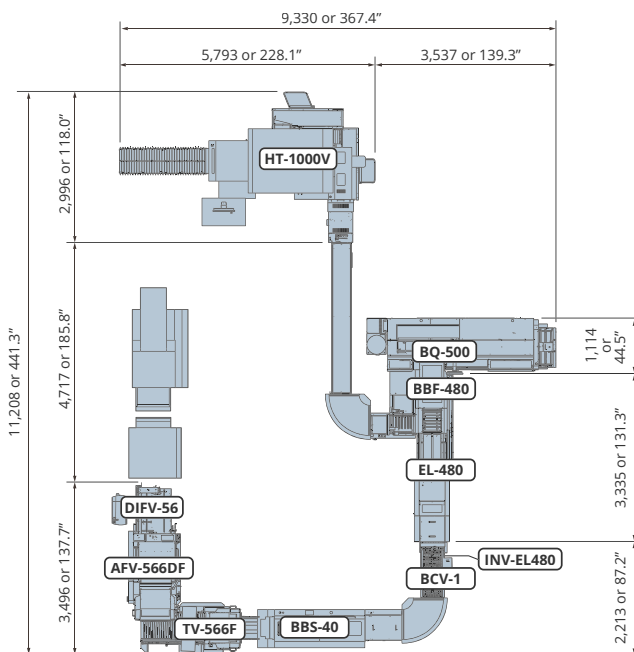

(Top View)

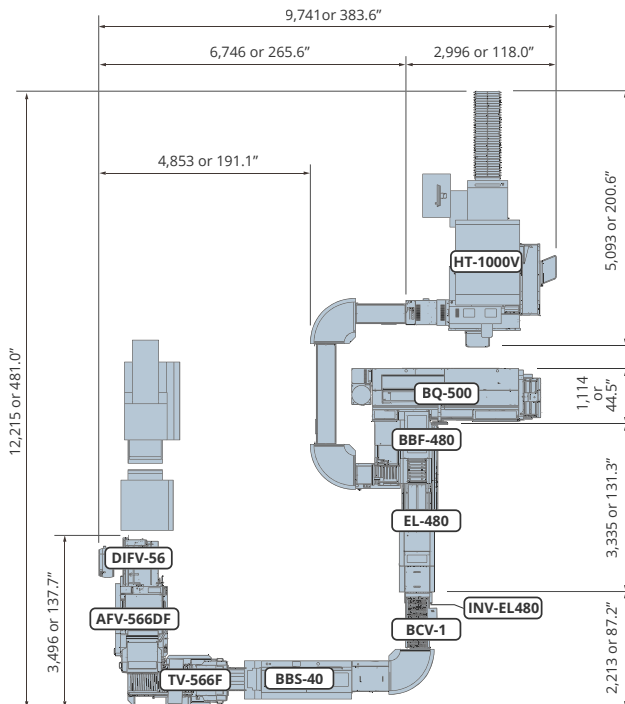

BQ-500

(Top View)

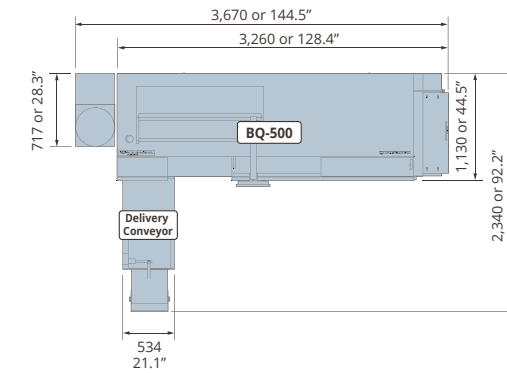

(Top View)

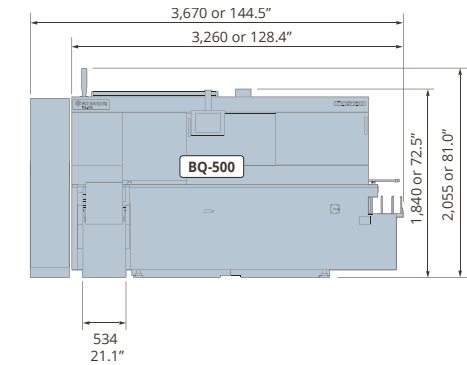

BQ-500				
Binding Type	Binding with milling, Binding without milling and Pad binding			
Glue Type	EVA Glue or PUR Glue (Tank is optional)			
Number of Carriage Clamps	4			
Book Block Size	<table border="1"> <tr> <td rowspan="2"> </td> <td>Spine Length x Fore-edge Length</td> </tr> <tr> <td>Max. 320 x 320 mm or 12.59" x 12.59" Min. 145 x 105 mm or 5.71" x 4.14"</td> </tr> </table>		Spine Length x Fore-edge Length	Max. 320 x 320 mm or 12.59" x 12.59" Min. 145 x 105 mm or 5.71" x 4.14"
	Spine Length x Fore-edge Length			
	Max. 320 x 320 mm or 12.59" x 12.59" Min. 145 x 105 mm or 5.71" x 4.14"			
Book Block Thickness	Min. 1 mm or 0.04" Max. 65 mm or 2.56"			
Cover Size	<table border="1"> <tr> <td rowspan="2"> </td> <td>Length x Width</td> </tr> <tr> <td>Max. 320 x 670 mm or 12.59" x 26.37" Min. 135 x 225 mm or 5.32" x 8.86"</td> </tr> </table>		Length x Width	Max. 320 x 670 mm or 12.59" x 26.37" Min. 135 x 225 mm or 5.32" x 8.86"
	Length x Width			
	Max. 320 x 670 mm or 12.59" x 26.37" Min. 135 x 225 mm or 5.32" x 8.86"			
Cover Weight Range	Normal Paper 81.4 to 302.4 gsm Coated Paper 104.7 to 348.9 gsm			
Cover Stack Height	Max. 150 mm or 5.9"			
Cycle Speed	Cover Binding (EVA glue) Max. 1,350 cycles per hour (EVA)			
	Cover Binding (PUR glue) Max. 1,000 cycles per hour (PUR)			
	Pad Binding Based on the cover binding (The glue temperature differs depending on conditions)			
	Lining Binding Max. 900 cycles per hour			
Voltage/Frequency	3-phase 200-208 V, 60 Hz 3-phase 220 V, 50 or 60 Hz 3-phase 400 V, 50 or 60 Hz (The external transformer is necessary for 220 V or 400 V)			
	Machine Dimensions	Delivery Conveyor (long type), and milling blower duct: 3,670 (W) x 2,340 (D) x 1,840 mm (H) (+ pole lamp 215 mm) or 144.5" (W) x 92.2" (D) x 72.5"(H) (+ pole lamp 8.5")		
		Without delivery stacker and milling blower duct: 3,260 (W) x 1,130 (D) x 1,840 (H) mm (+ pole lamp 215 mm) or 128.4" (W) x 44.5" (D) x 72.5" (H) (+ pole lamp 8.5")		

BBF-480				
Binding Type	Type of Book Block: Sheet block unified by glue			
Book Block Size	<table border="1"> <tr> <td rowspan="2"> </td> <td>Spine Length x Fore-edge Length</td> </tr> <tr> <td>Max. 320 x 320 mm or 12.59" x 12.59" Min. 145 x 105 mm or 5.71" x 4.14"</td> </tr> </table>		Spine Length x Fore-edge Length	Max. 320 x 320 mm or 12.59" x 12.59" Min. 145 x 105 mm or 5.71" x 4.14"
	Spine Length x Fore-edge Length			
	Max. 320 x 320 mm or 12.59" x 12.59" Min. 145 x 105 mm or 5.71" x 4.14"			
Book Block Thickness	Min. 1 mm or 0.04" Max. 65 mm or 2.56"			
Cycle Speed	Max. 1,000 cycles per hour: With same thickness of book (EVA, at the maximum speed of carriage clamps)			
	Max. 800 cycles per hour: With 5 mm variable thickness of book (EVA, at the maximum speed of carriage clamps)			
	Max. 660 cycles per hour: With 30 mm variable thickness of book (EVA, at the maximum speed of carriage clamps) Max. 400 cycles per hour: With 64 mm variable thickness of book (EVA, with the auto setting according to the thickness of book)			
Voltage/Frequency	3-phase 200-230 V, 50 or 60 Hz			
Machine Dimensions	1,080 (W) x 1,730 (D) x 1,610 mm (H) or 42.6" (W) x 68.2" (D) x 63.4"(H) (The rail plate is not included.) *The depth of the machine changes according to the position of the feeding unit.			

*The machine design and specifications are subject to change without any notice.
 *Specifications may vary depending on the job, paper quality, environmental influences, and various other factors. Please do a test run before starting production.

MORE AT
HORIZON.CO.JP



Horizon

Horizon International Inc.

510 Kuze Ooyabu-cho, Minami-ku,
Kyoto, 601-8206, Japan
Phone : +81-75-934-6700
Fax : +81-75-934-6708
www.horizon.co.jp

Distributed by

 **STANDARD**

Standard Finishing Systems

10 Connector Road, Andover,
MA 01810
Phone : 877-404-4460 / 978-470-1920
Fax : 978-470-2771
www.standardfinishing.com