

version 1.1

aykah

ASSEMBLY SHEET



Theo/Eiffel Dining Table



No. of People: 1

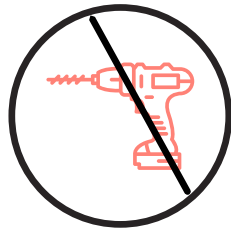

NO power tools required.

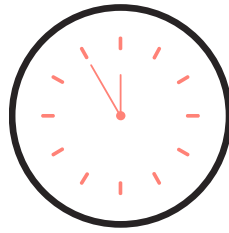

Time: 25 minutes



Use a damp cloth to clean.











Level of difficulty: 2/4





ASSEMBLY INSTRUCTIONS

Thank you for making a purchase with Aykah. The goal of this assembly sheet is to help you assemble the product in a way that will contribute to its longevity and durability. Kindly follow all the instructions carefully to ensure a safe and accurate assembling process.

A few important things to note:

- Please do not use a power tool to assemble this product. Using one may hinder and/or damage the item and will invalidate any claims for warranty.
- Depending on the amount of use this product receives, it may be recommended to tighten up the fixings from time to time. This is completely normal!

ID	Description	Qty
A	Top 	1
B	Legs 	4
C	Metal Star 	4
D	Connector 	2
E	Allen Key 	1
F	Nut Tight 	1
G	M6 X50 MM Bolt 	4
H	M6 X40 MM Bolt 	4

ID	Description	Qty
I	Nut 	8
J	M6 X15 MM Bolt 	4
K	Washer 	4
L	Cap 	8

1

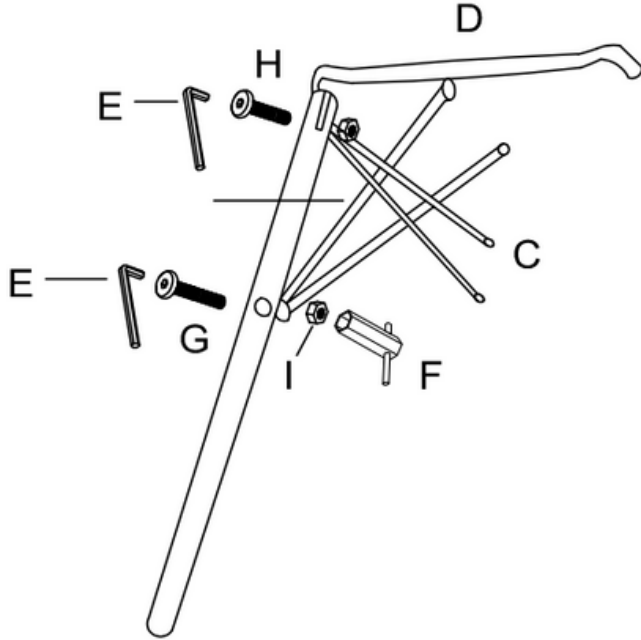

2

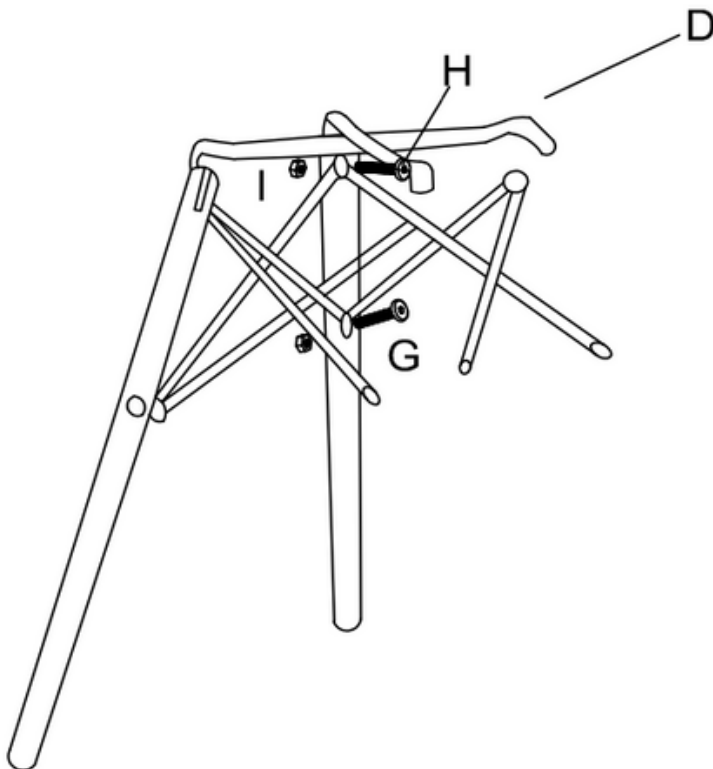

3

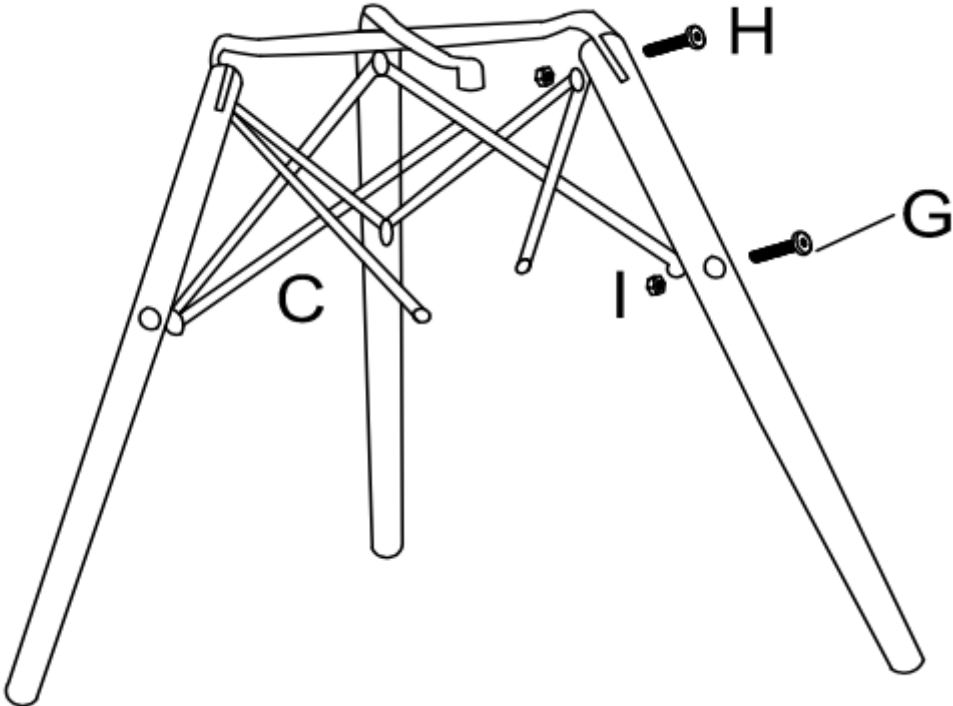

4

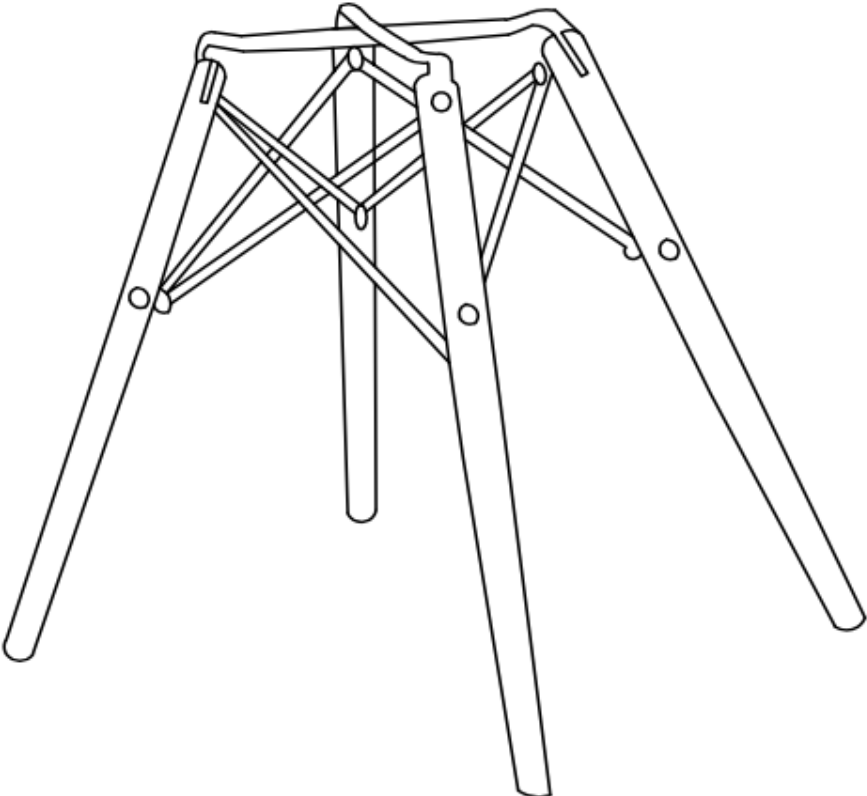

3

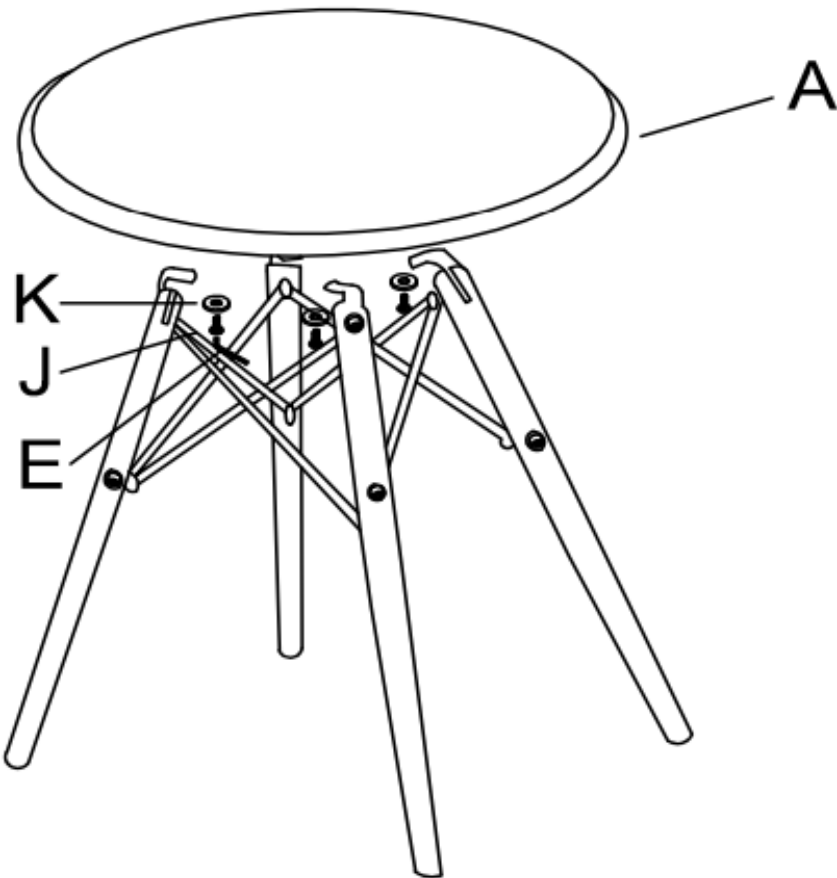

4

