

version 1.1

aykah

ASSEMBLY SHEET



Theo/Eiffel Counter Stool



No. of People: 1

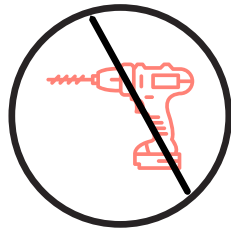

NO power tools required.

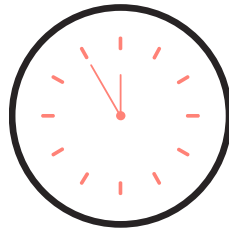

Time: 25 minutes



Use a damp cloth to clean.

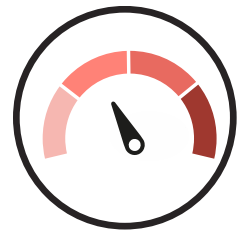









Level of difficulty: 2/4









ASSEMBLY INSTRUCTIONS

Thank you for making a purchase with Aykah. The goal of this assembly sheet is to help you assemble the product in a way that will contribute to its longevity and durability. Kindly follow all the instructions carefully to ensure a safe and accurate assembling process.

A few important things to note:

- Please do not use a power tool to assemble this product. Using one may hinder and/or damage the item and will invalidate any claims for warranty.
- Depending on the amount of use this product receives, it may be recommended to tighten up the fixings from time to time. This is completely normal!

ID	Description	Qty
A	Metal Bracket 	1
B	Metal Bracket 	1
C	Metal Bracket 	2
D	Legs 	4
E	Seat 	1
F	Star 	1
G	M6 X50 MM Bolt 	4
H	M6 X40 MM Bolt 	4
I	M6 X35 MM Bolt 	4

ID	Description	Qty
J	M6 X16 MM Bolt 	4
K	Nut 	12
L	Cap 	12
M	Washer 	4
N	Spring Pad 	4
O	Allen Key 	1
P	Nut Holding Tool 	1
Q	Ring 	4

Common Question: How to distinguish between metal pieces A, B and C? It should be engraved on the metal pieces. :)

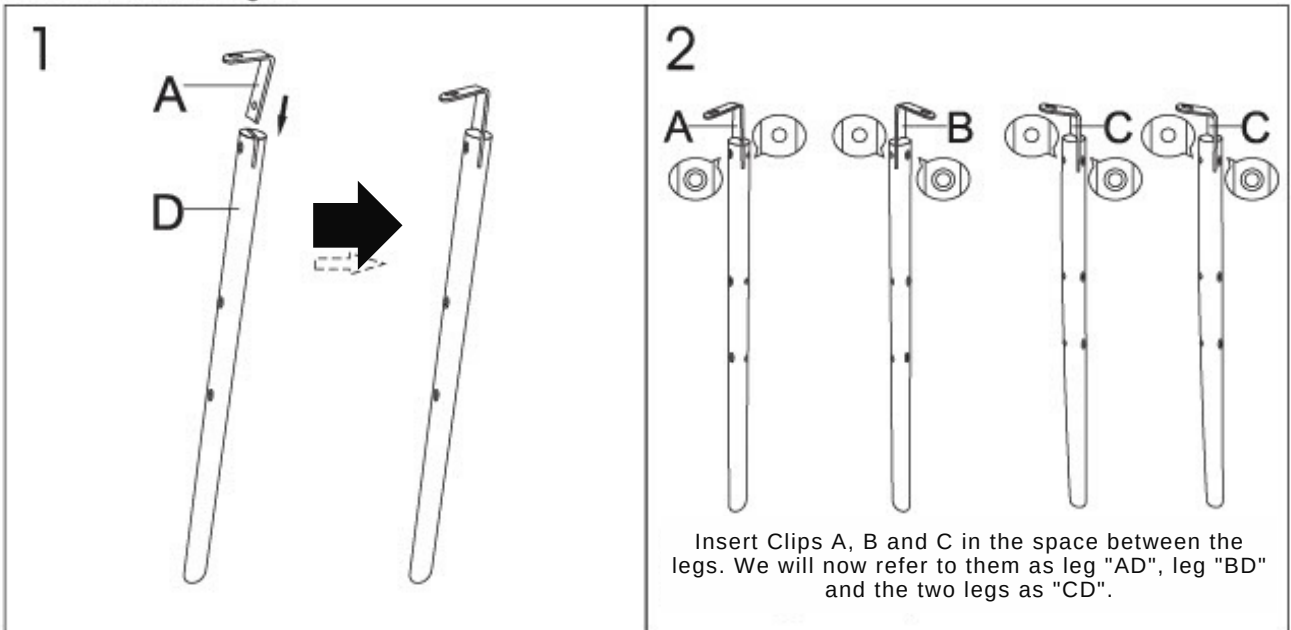

**Please Note for Step 3:
The screw is inserted in the side that has a double hole, not the side with a single hole.**

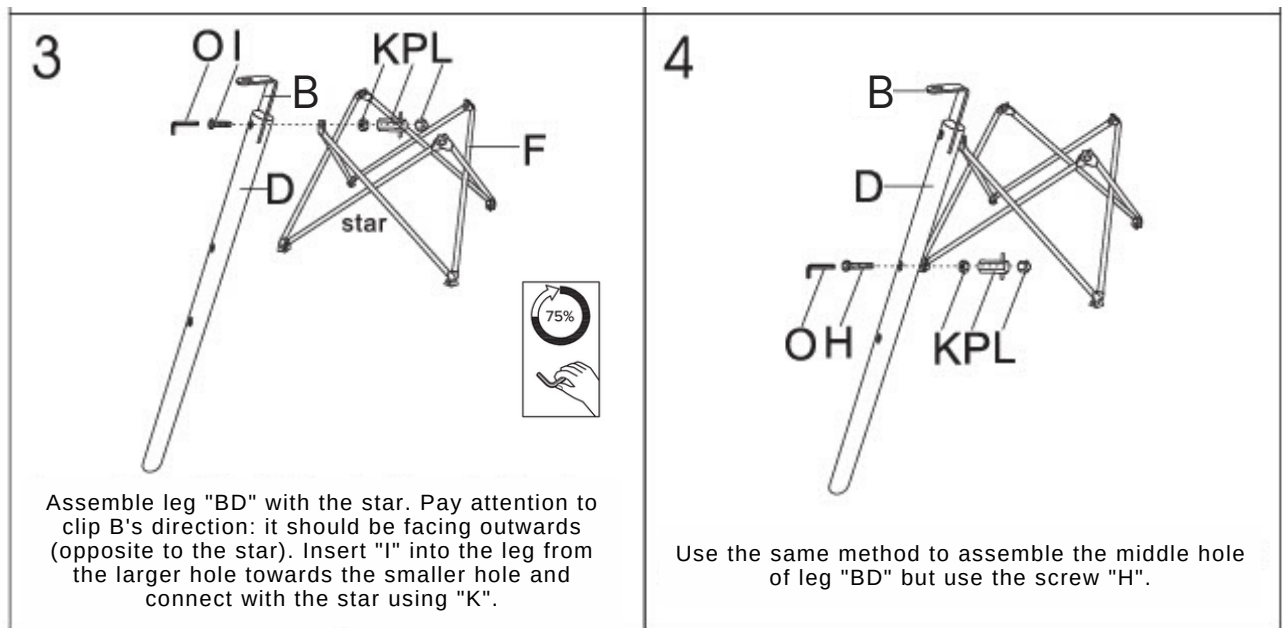
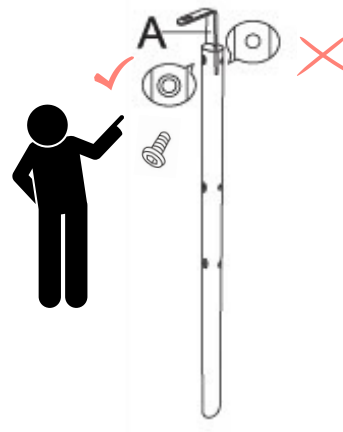

Note for Step 5:
Make sure metal parts A and B are facing in the opposite direction and are facing outwards, towards the leg as shown in the picture below.

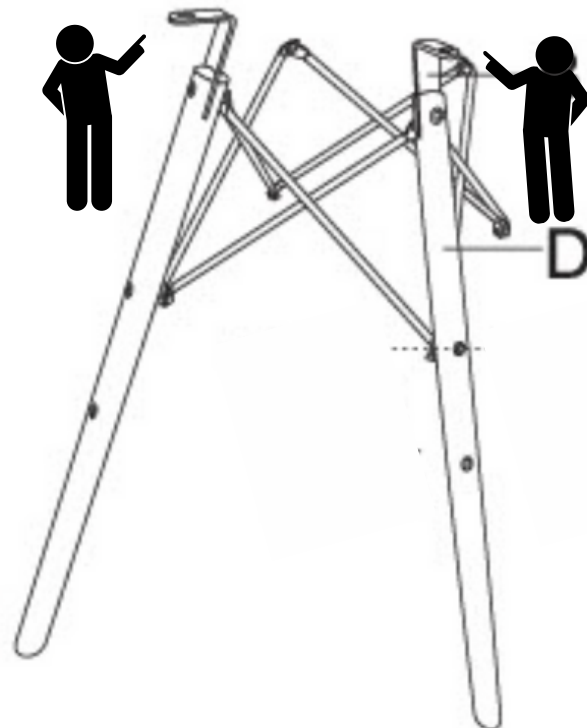

<p>5</p> <p>Please assemble leg "AD" after leg "BD" (same process), and pay attention to Clip A's direction (should be opposite to the star).</p>	<p>6</p> <p>Use the same method to assemble the middle hole of leg "AD" but use screw "H"</p>
---	---

Notes for Step 7 and Step 9:
Make sure metal part C is facing inwards in the same direction and towards the star as shown in the picture below.

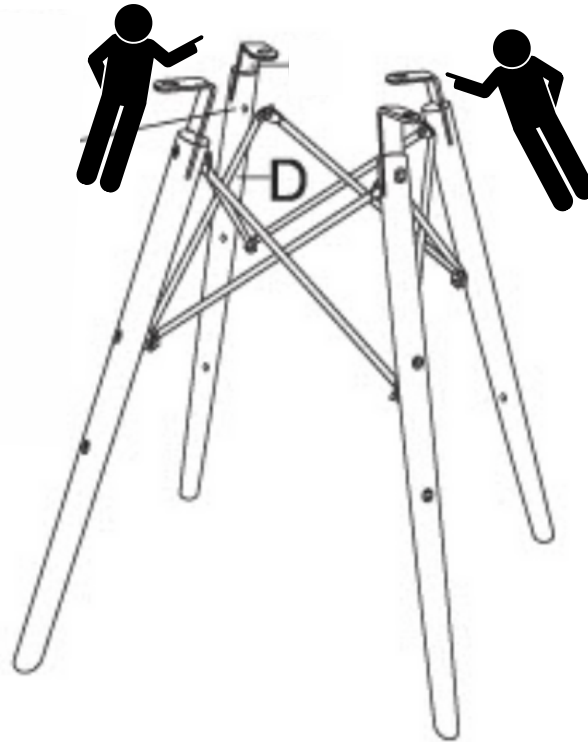

7

For leg "CD", pay attention to Clip C's direction (should be towards the star). Use screw "I".

8

Assemble the middle hole of leg "CD" using screw "H".

**Notes for Step 7 and Step 9:
Make sure metal part C is facing in the same direction and towards the star as shown in the picture below.**

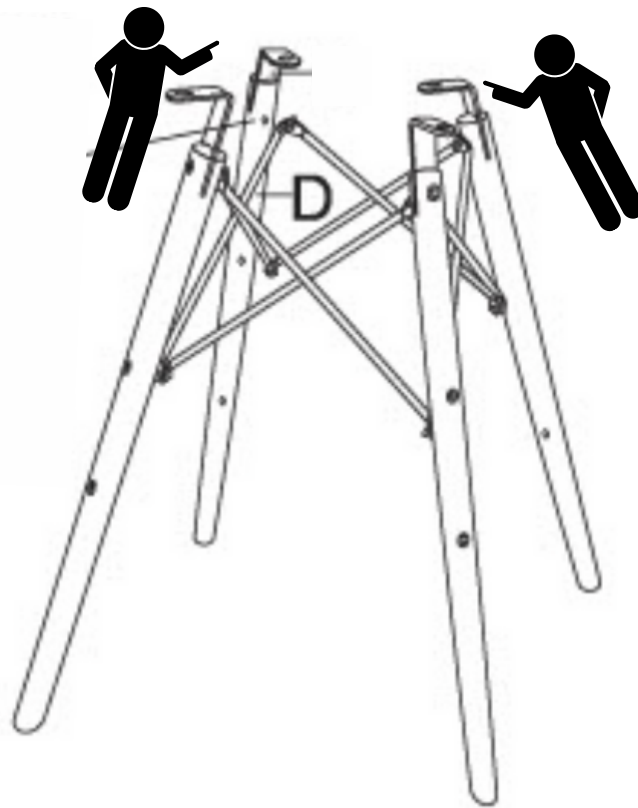

9

For leg "CD", pay attention to clip C's direction (should be towards the star). Use screw "I".

10

Assemble the middle hole of leg "CD" using screw "H".

