

version 1.1

aykah

ASSEMBLY SHEET



Luke Counter Stool



No. of People: 1

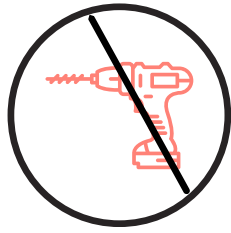

NO power tools required.



Time: 10 minutes



Use a damp cloth to clean.















Level of difficulty: 1/4

ASSEMBLY INSTRUCTIONS

Thank you for making a purchase with Aykah. The goal of this assembly sheet is to help you assemble the product in a way that will contribute to its longevity and durability. Kindly follow all the instructions carefully to ensure a safe and accurate assembling process.

A few important things to note:

- Please do not use a power tool to assemble this product. Using one may hinder and/or damage the item and will invalidate any claims for warranty.
- Depending on the amount of use this product receives, it may be recommended to tighten up the fixings from time to time. This is completely normal!

PARTS INVENTORY			
ID	DESCRIPTION		QTY
A	Seat		1
B	Side Footrest	 LARGER	2
C	N Shaped Leg		1
D	U Shaped Leg		1
E	Front Footrest	 SMALLER	2
F	M6 X 35MM Bolt		9
G	M6 X 55MM Bolt		4
H	Washer		4
I	Allen Key		1
J	Cushion		2
K	M6 X 20MM Bolt		2
L	Spring Pad		4

1

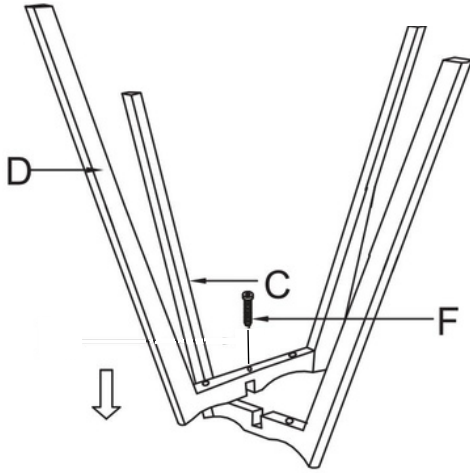

2

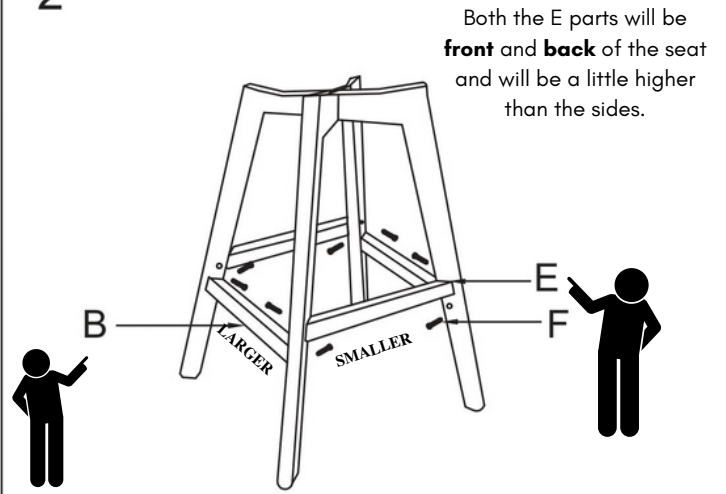

Both B parts will be opposite to each other and on the **side** of the seat and lower than the front and back footrest.

3

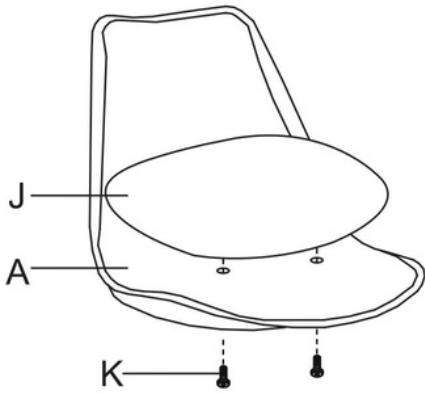

4

