

aykah

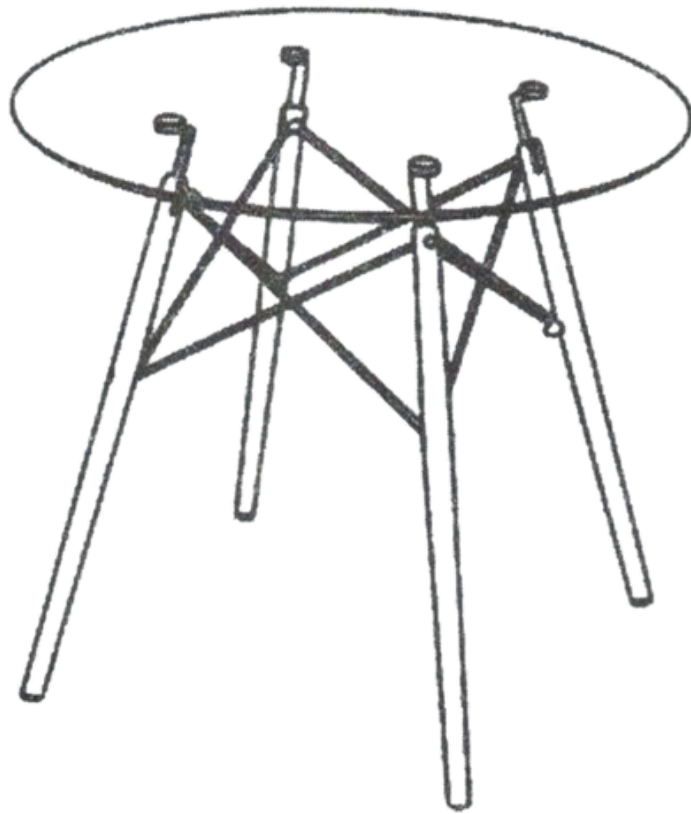

Eiffel Glass Dining Table



No. of People: 1

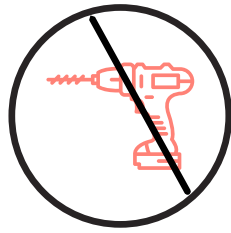

NO power tools required.

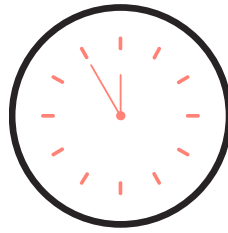

Time: 25 minutes



Use a damp cloth to clean.

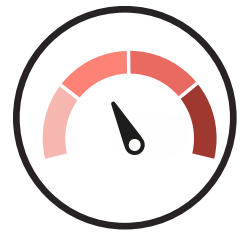









Level of difficulty: 2/4





ASSEMBLY INSTRUCTIONS

Thank you for making a purchase with Aykah. The goal of this assembly sheet is to help you assemble the product in a way that will contribute to its longevity and durability. Kindly follow all the instructions carefully to ensure a safe and accurate assembling process.

A few important things to note:

- Please do not use a power tool to assemble this product. Using one may hinder and/or damage the item and will invalidate any claims for warranty.
- Depending on the amount of use this product receives, it may be recommended to tighten up the fixings from time to time. This is completely normal!

ID	Description	Qty
A	Top 	1
B	Legs 	4
C	Metal Star 	4
D	Brackets 	4
E	M6 X35 MM Bolt 	4
F	M6 X40 MM Bolt 	4
G	Nut 	8
H	M6 X8 MM Bolt 	4

ID	Description	Qty
I	Washer 	4
J	Nut Tight 	1
K	Allen Key 	1
L	Cap 	8

1

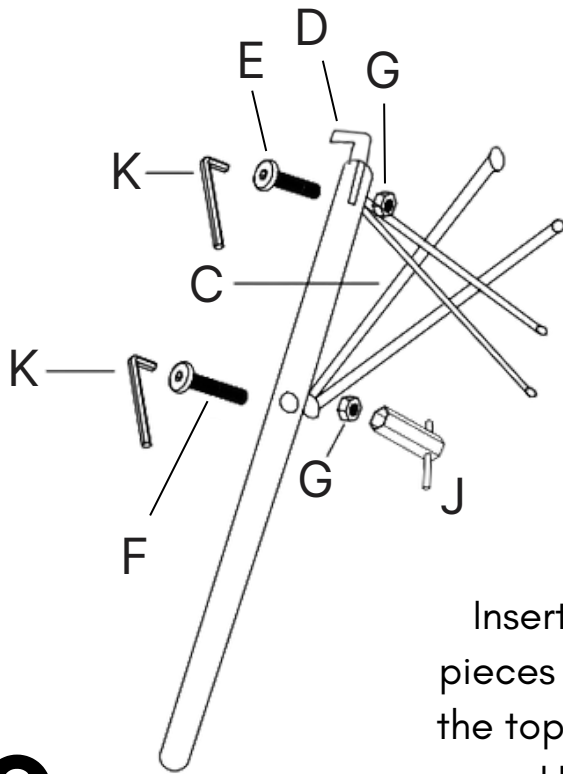

Insert bracket D and attach the metal star pieces to the legs using screw E and nut G on the top and screw F and nut G on the bottom. Use part J to hold the nut in place.

2

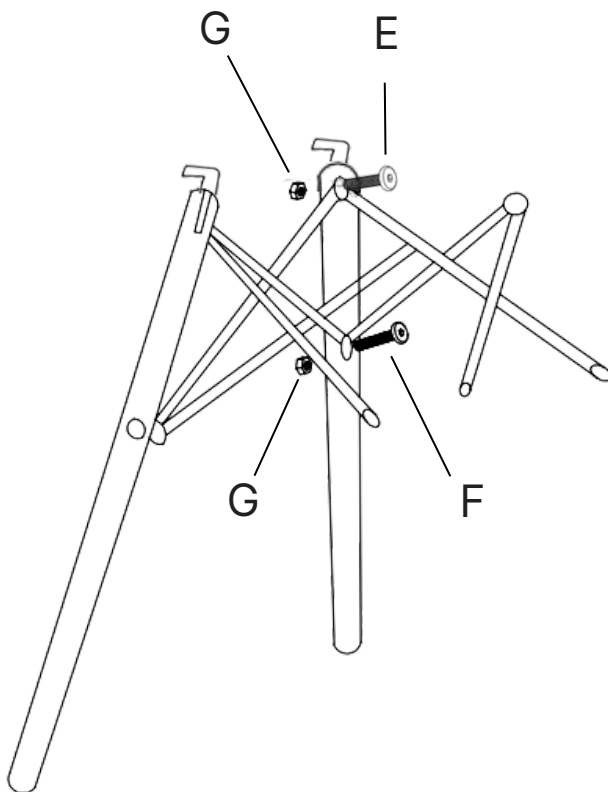

Repeat for all legs.

3

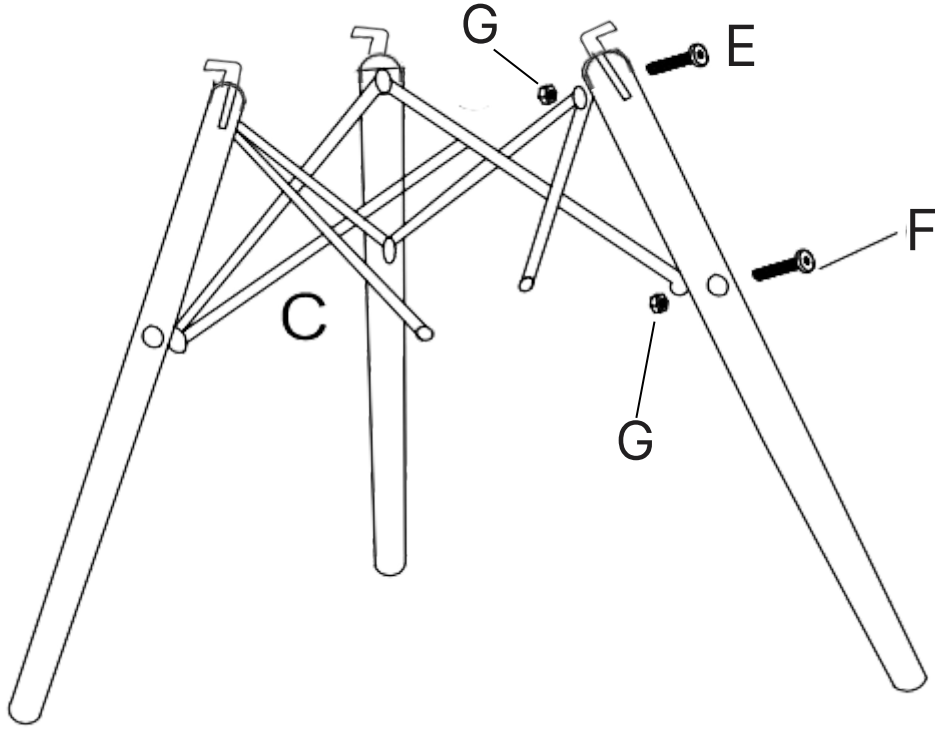

4

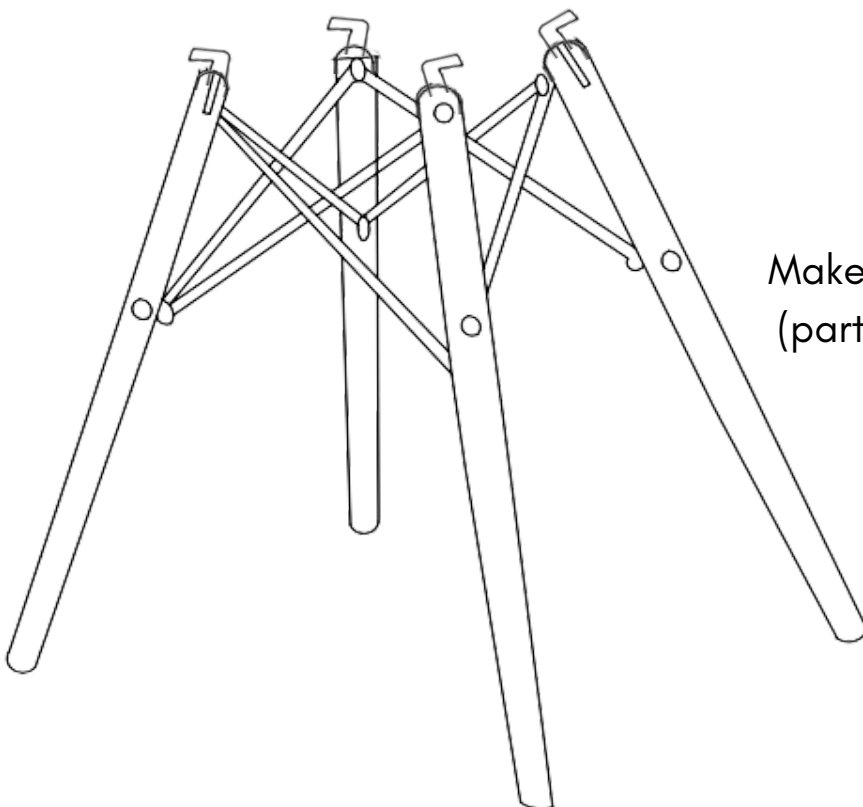

Make sure all the metal brackets (part D) are facing outwards as shown in the picture.

5

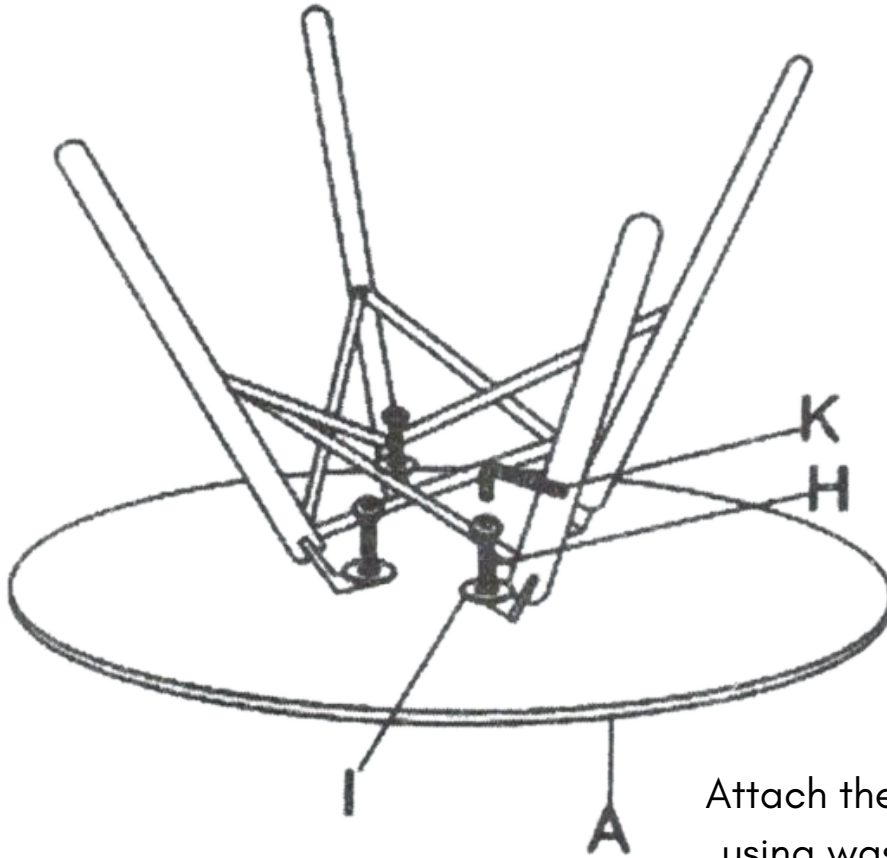

Attach the legs to the tabletop using washer 'I' and screw 'H'.

6

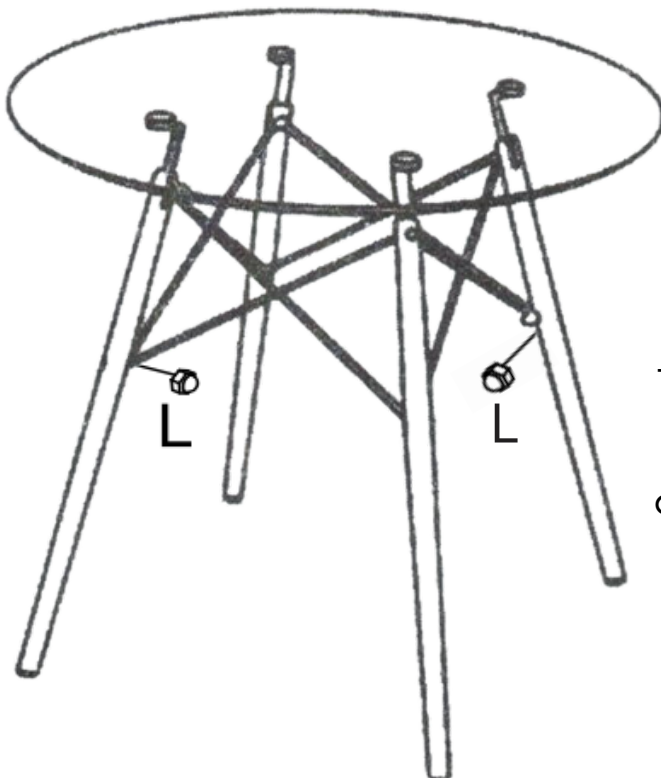

Tighten all the screws at the end using the Allen key (part K) to adjust the legs. Attach the screw caps (Part L) to all the screws.