

## SAFE BATTERY USAGE

- Use alkaline batteries for best performance and longer life.
- Use only the battery type recommended for the unit.
- Batteries should be replaced only by an adult.
- Insert batteries with the correct polarity (+ and -).
- Do not mix old and new batteries.
- Do not mix alkaline, standard (carbon-zinc), or rechargeable batteries.
- Do not short-circuit batteries.
- When not used for an extended time, remove batteries to prevent possible leakage and damage to the unit.
- Do not mix rechargeable and non-rechargeable batteries.
- Rechargeable batteries are to be removed from the toy before charging.
- Rechargeable batteries are to be recharged only under adult supervision.
- Do not recharge non-rechargeable batteries.
- Exhausted batteries are to be removed from the toy.
- Do not dispose of batteries in fire as they may leak or explode.



### WARNING:

This product contains a button cell battery. A button cell battery can cause severe or fatal injuries in as little as two hours if it is swallowed or placed inside any part of the body. Dispose of used batteries immediately. Keep new and used batteries away from children. If you think batteries might have been swallowed or placed inside any part of the body, seek immediate medical attention.

### IMPORTANT NOTES ABOUT BUTTON BATTERIES

- WARNING - KEEP BATTERIES OUT OF REACH OF CHILDREN
- Swallowing may lead to serious injury in as little as 2 hours or death, due to chemical burns and potential perforation of the esophagus.
- If you suspect your child has swallowed or inserted a button battery immediately call the 24-hour Poisons Information Centre on 13 1126 (Australia)/ your local emergency services for fast, expert advice.
- Examine devices and make sure the battery compartment is correctly secured, e.g. that the screw or other mechanical fastener is tightened. Do not use if compartment is not secure.
- Dispose of used button batteries immediately and safely. Flat batteries can still be dangerous.
- Adults shall tell potential users about the risk of button batteries and keep their children away from button cell. Adult supervision is required.



'Let's care for the environment!'

The wheelie bin symbol indicates that the product must not be disposed of with other household waste. Please use designated collection points or recycling facilities when disposing of the item. Do not treat old batteries as household waste. Take them to a designated recycling facility.



# TO-GO DINER

**WARNING:**  
CHOKING HAZARD-Small parts.  
Not for children under 3 years.

ADULT SUPERVISION REQUIRED  
ADULT BATTERY INSTALLATION REQUIRED

## CONTENTS

- A. Diner
- B. Drink Dispenser (with Lid)
- C. Sign (with Post)
- D. Fryer and Basket
- E. Utensils
  - Burger Spatula
  - Spatula
  - Brush
  - Tongs
- F. 2 Cups
- G. Cup Holder
- H. Pitcher
- I. Ketchup and Mustard
- J. Pie
- K. Fries and Sweet Potato Fries
- L. Cheeseburger
  - Plate with Bun
  - Bun
  - Cheese
  - Tomato
  - Lettuce
  - Burger Patty
- M. Food Container
- N. Food Tissue Paper
- O. Pie Box
- P. Menu
- Q. Register Screen with Hook
- R. Doll with Accessories
  - Purse (Not Shown)
  - Headband
  - Necklace
  - Earrings
  - Hair Brush (Not Shown)
  - Stand (Not Shown)

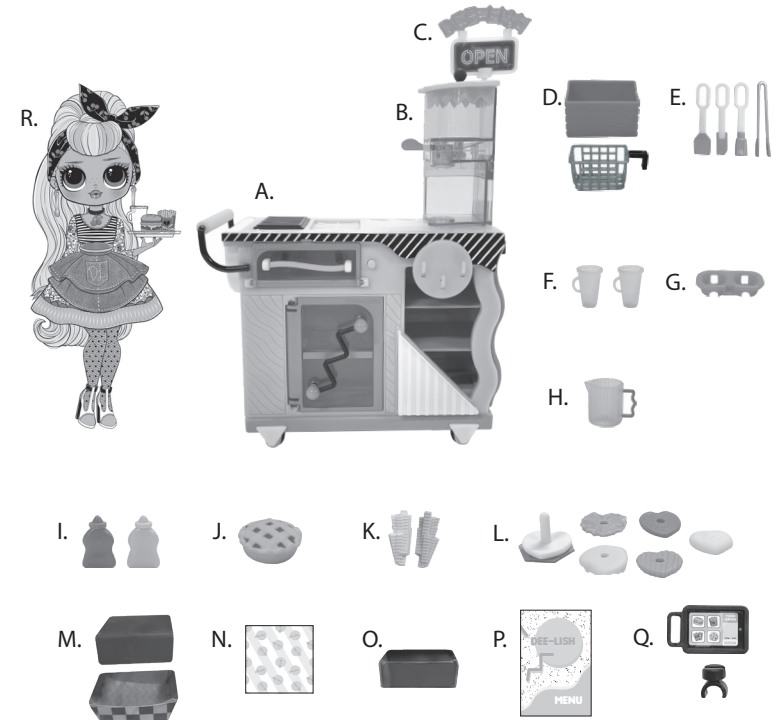

Illustrations are for reference only. Styles may vary from actual contents.

Please remove all packaging including tags, ties & tacking stitches before giving this product to a child.

## BATTERY REPLACEMENT

An adult must install fresh alkaline batteries in the diner should the batteries need replacing. Here's how:

1. Using a Phillips screwdriver (not included) remove the screw and battery compartment cover from the side of the diner.
2. Install three (3) 1.5V AG13 (LR44) alkaline batteries (not included) making sure the (+) and (-) ends face the proper direction as indicated inside the battery compartment.
3. Replace the compartment cover and tighten the screw.

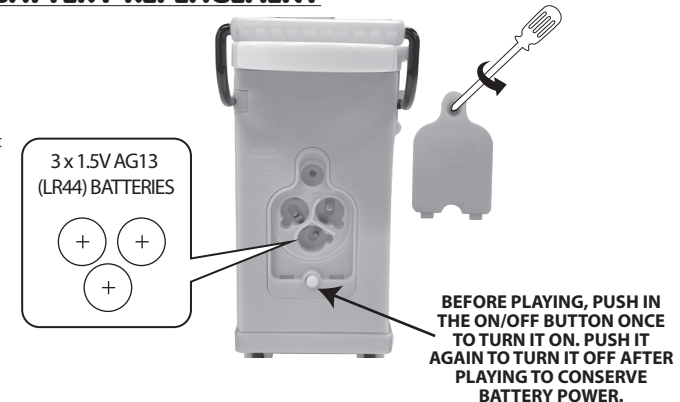

Please keep this manual as it contains important information.



0222-0-EINT  
Printed in China

www.LOLsurprise.com  
©2022 MGA Entertainment, Inc.  
L.O.L. SURPRISE!™, L.O.L. SURPRISE! O.M.G. OUTRAGEOUS  
MILLENNIAL GIRLS™ and HOUSE OF SURPRISES!™ are  
trademarks of MGA in the U.S. and other countries. All  
logos, names, characters, likenesses, images, slogans, and  
packaging appearance are the property of MGA.

**MGA Entertainment, Inc.**  
9220 Winnetka Ave. Chatsworth, CA 91311 U.S.A.  
(800) 222-4685

**MGA Entertainment UK Ltd.**  
50 Presley Way, Crownhill, Milton Keynes,  
MK8 0ES, Bucks, UK  
+ 0800 521 558

**MGA Entertainment (Netherlands) B.V.**  
Baronie 68-70, 2404 XG Alphen a/d Rijn, The Netherlands  
Tel: +31 (0) 172 758038

**Imported by MGA Entertainment Australia Pty Ltd**  
Suite 2.02, 32 Delhi Road  
Macquarie Park NSW 2113  
1300 059 676

The preferred method of contact for  
Customer Service is through our e-mail  
contact form at [www.mgae.com](http://www.mgae.com)

Before beginning, cover the play area to prevent possible water damage.

## ASSEMBLY

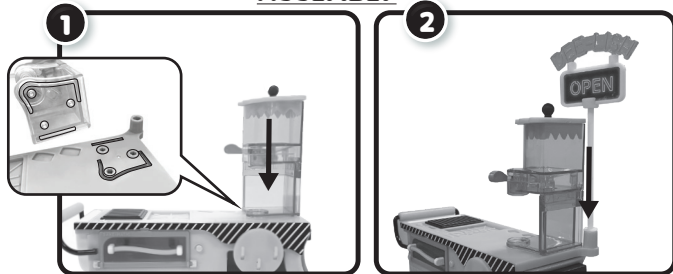

## QUICK START UV COLOR-CHANGE!

**IMPORTANT NOTE:** Allow the pie, burger patty, and bun to sit under the UV light for a few minutes. The longer it is under the light, the more the color change will be visible.

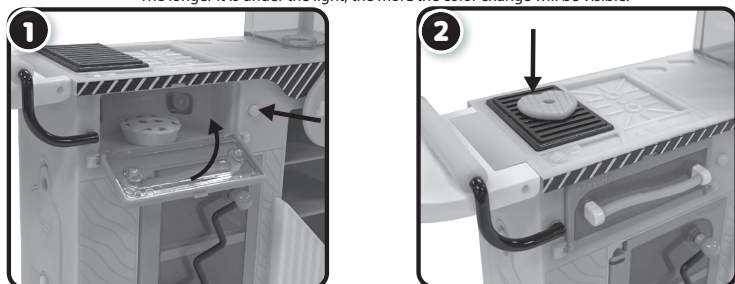

Open the oven door. Insert the pie and then close the door. Press the ON/OFF button next to the oven to turn on the UV lights. Pie changes color!

Place the burger patty or burger bun on top of the grill. Push down on the grill to turn on the UV light. Grill stripes will appear on the patty or bun.

## WATER COLOR-CHANGE!

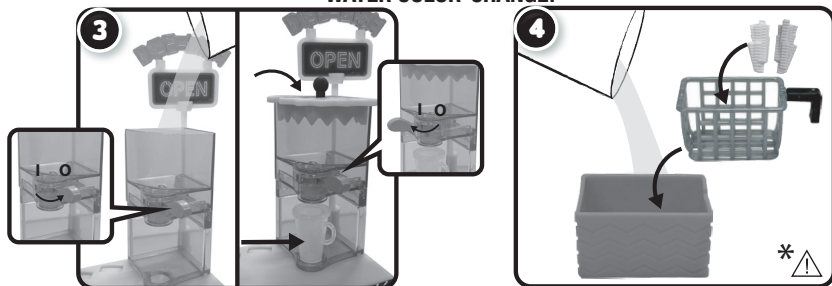

Make sure the handle is in the closed position (O) on the drink dispenser. Remove the cover. Then add ice cold water and replace the cover. Place the cup under the drink dispenser and move the handle to the open position (I). Cups change color!

Pour warm water into the fryer. Insert the fries or sweet potato fries into the basket. Then, dip the basket into the fryer. Fries change color!

## OTHER FEATURES!

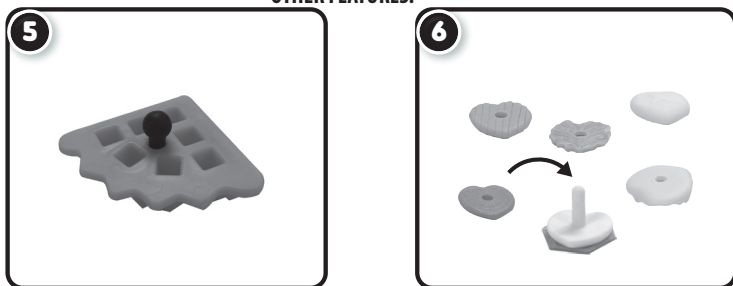

The cover is also an ice tray. Pour water into the slots on top of the cover and insert the tray into your own freezer. Pop out the ice cubes to insert into the cups.

Assemble the cheeseburger. Insert the patty, lettuce, tomato, and cheese into the bun attached to the plate. Then top it off with the last bun.

## DINER

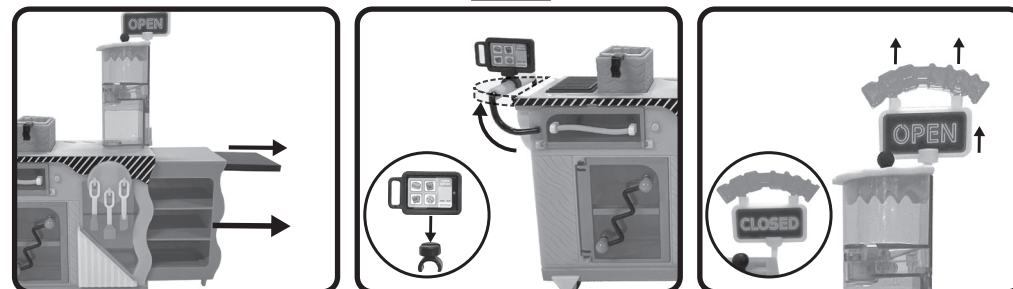

Diner can be extended. Pull out the side wall and then pull out the smaller table. Push it back in to retract.

Attach the register screen to the hook and then attach the hook to the handle. Table under handle can also be flipped up or down.

Sign can be switched from "Open" to "Closed" and vice versa. Remove the sign and reverse it. Replace it on the hook. Then, remove the name and reverse it.

## STORAGE

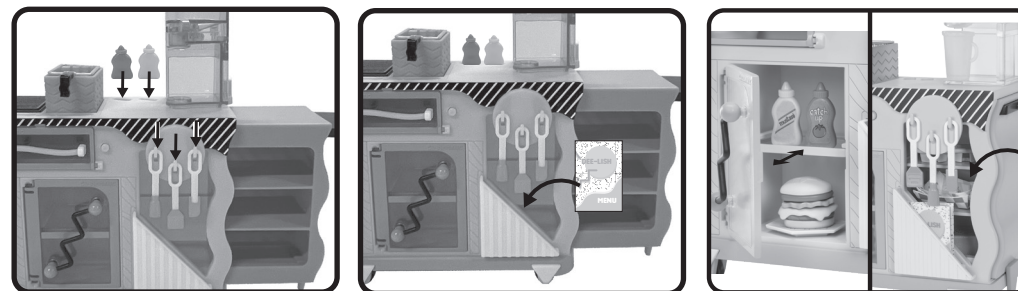

Store the spatulas, brush, ketchup and mustard bottles!

Store the menu!

Store items in the refrigerator or shelves! The top shelf in the refrigerator slides in and out.

## DOLL STAND

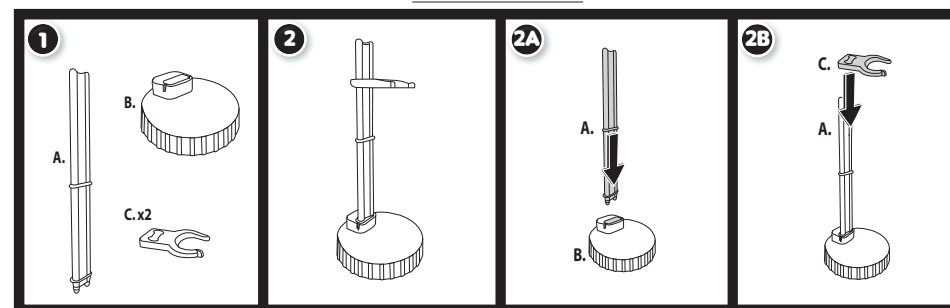

## IMPORTANT INFORMATION

- Do not look directly into the UV lights.
- Always close the oven door before turning on UV light.
- Keep moisture away from the battery compartment and areas with the UV light.
- Keep long hair and other loose objects, like shoelaces, away from the rotating tires of the diner.
- Do not play with diner in the street or where there is vehicular traffic or in heavily traveled areas with pedestrians.
- Do not stand on, sit on or throw diner as doing so can result in injury to the person and irreparable damage to the unit.
- Avoid driving the diner through water, mud, etc.

## \* ⚠ WARNING

An adult must be present and supervise when placing the fries in warm water, as the water may be hot.

## COLOR-CHANGE

- Use ice water, approximately 32°F (0°C) for best cold color change result.
- Warm color change will start at approximately 100.4°F (38°C) but best results occur if the water is approximately 104°F (40°C).
- Cold color change will only work on the cups and warm color change will only work on the fries.
- UV color change will only work on the burger patty, bun, and the pie.
- Not all included fashions or accessories change color in cold/warm water or under UV light.
- Extreme weather conditions may cause the color change pattern reveal upon arrival. To return it to its original color, place water color-changing items in a room temperature area at approximately 68-77°F (20-25°C).
- If color change does not work properly or quickly, the temperature of the cups or fries may be too close to the temperature of the water.
- Color change temperatures may vary according to weather conditions.
- The color-change effect has a lengthy, but limited lifespan.