

SAFE BATTERY USAGE

- Use alkaline batteries for best performance and longer life.
- Use only the battery type recommended for the unit.
- Batteries should be replaced only by an adult.
- Insert batteries with the correct polarity (+ and -).
- Do not mix old and new batteries.
- Do not mix alkaline, standard (carbon-zinc), or rechargeable batteries.
- Do not short-circuit batteries.
- When not used for an extended time, remove batteries to prevent possible leakage and damage to the unit.
- Do not mix rechargeable and non-rechargeable batteries.
- Rechargeable batteries are to be removed from the toy before charging.
- Rechargeable batteries are to be recharged only under adult supervision.
- Do not recharge non-rechargeable batteries.
- Exhausted batteries are to be removed from the toy.
- Do not dispose of batteries in fire as they may leak or explode.

FCC COMPLIANCE

NOTE: This equipment has been tested and found to comply with the limits for a Class B digital device, pursuant to Part 15 of the FCC Rules. These limits are designed to provide reasonable protection against harmful interference in a residential installation. This equipment generates, uses and can radiate radio frequency energy and, if not installed and used in accordance with the instructions, may cause harmful interference to radio communications. However, there is no guarantee that interference will not occur in a particular installation. If this equipment does cause harmful interference to radio or television reception, which can be determined by turning the equipment off and on, the user is encouraged to try to correct the interference by one or more of the following measures:

- Reorient or relocate the receiving antenna.
- Increase the separation between the equipment and receiver.
- Connect the equipment into an outlet on a circuit different from that to which the receiver is connected.
- Consult the dealer or an experienced radio/TV technician for help.

This device complies with Part 15 of the FCC Rules. Operation is subject to the following two conditions: (1) This device may not cause harmful interference, and (2) this device must accept any interference received, including interference that may cause undesired operation.

Caution: Modifications not authorized by the manufacturer may void users authority to operate this device.

CAN ICES-3 (B)/NMB-3(B).



'Let's care for the environment!'

The wheelie bin symbol indicates that the product must not be disposed of with other household waste. Please use designated collection points or recycling facilities when disposing of the item. Do not treat old batteries as household waste. Take them to a designated recycling facility.

Please keep this manual as it contains important information.



0422-0-EINT
Printed in China

MGA Entertainment, Inc.
9220 Winnetka Ave. Chatsworth, CA 91311 U.S.A.
(800) 222-4685

MGA Entertainment UK Ltd.
50 Presley Way, Crownhill, Milton Keynes,
MK8 0ES, Bucks, UK
+ 0800 521 558

www.LOLsurprise.com
©2022 MGA Entertainment, Inc.
L.O.L. SURPRISE!™ and MINI L.O.L. SURPRISE!™ are
trademarks of MGA in the U.S. and other countries. All
logos, names, characters, likenesses, images, slogans, and
packaging appearance are the property of MGA.

The preferred method of contact for
Customer Service is through our e-mail
contact form at www.mgae.com

MGA Entertainment (Netherlands) B.V.
Baronie 68-70, 2404 XG Alphen a/d Rijn, The Netherlands
Tel: +31 (0) 172 758038

Imported by MGA Entertainment Australia Pty Ltd
Suite 2.02, 32 Delhi Road
Macquarie Park NSW 2113
1300 059 676



CLAW MACHINE

WARNING:
CHOKING HAZARD—Small parts.
Not for children under 3 years.

SKU: 583974

ADULT SUPERVISION REQUIRED

REMOVING THE PACKAGING MATERIALS

Before playing, an **ADULT** must remove the packaging materials inside the claw machine. Follow the directions below:

1. Cut the zip tie on the back of the claw machine.
2. Using a Phillips screwdriver (not included), remove the two screws.
3. Remove the back panel and then remove the packaging materials.
4. Replace back panel and then tighten the screws.

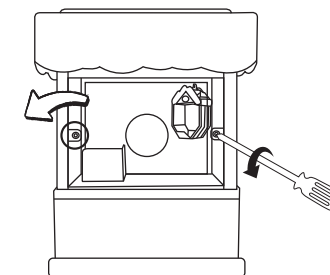

CONTENTS

- A. 1 Claw Machine
- B. 3 Surprise Characters and 2 Sticker Sheets in capsules

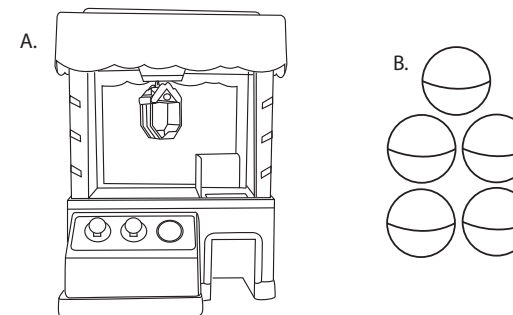

Illustrations are for reference only. Styles may vary from actual contents. Please remove all packaging including tags, ties & tacking stitches before giving this product to a child.

ADULT BATTERY INSTALLATION

Before playing, an adult must install fresh alkaline batteries (not included) in the unit. Here's how:

1. Using a Phillips screwdriver (not included) remove the screw and battery compartment cover from under the claw machine.
2. Install four (4) 1.5V AA (LR6) alkaline batteries (not included) making sure the (+) and (-) ends face the proper direction as indicated inside the battery compartment.
3. Replace the compartment cover and tighten the screw.

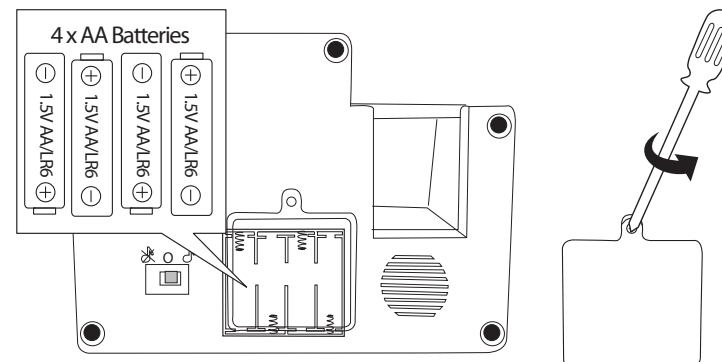

QUICK START

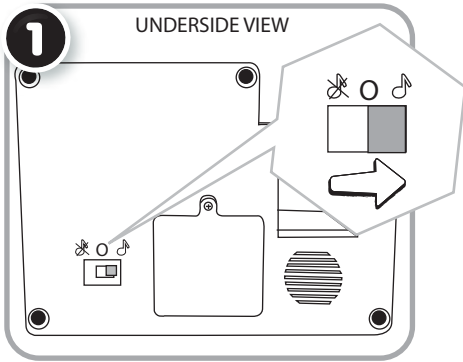

Move the switch to the Volume (🔊) or Silent (🔇) position.

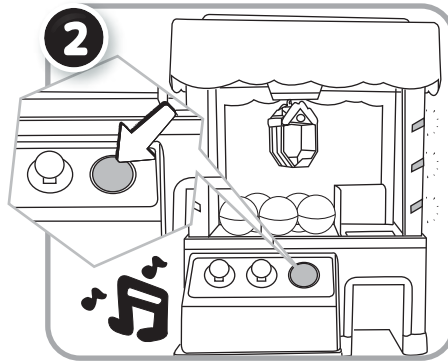

Press the button on the front of the machine to start. A song will start playing (if it is in the Volume position), and the machine will light up. You have one minute to try to grab a prize with the claw.

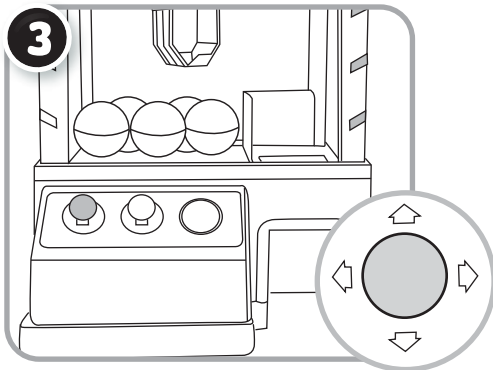

Use the left joystick to move the claw left or right, forward or backward.

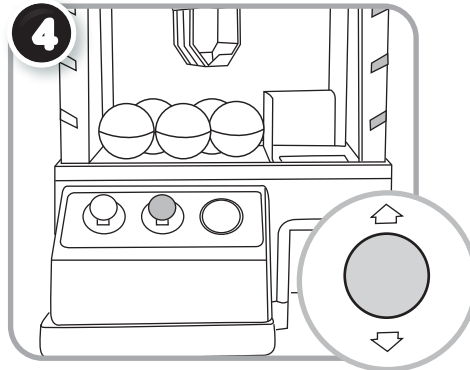

Use the right joystick to move the claw up and down. It will open and close as you move it up or down.

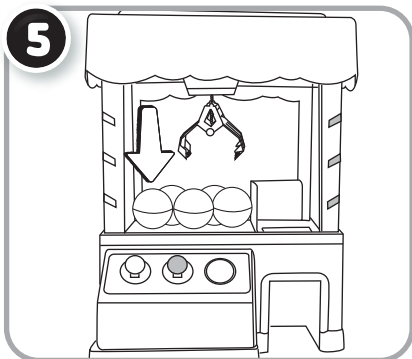

Bring the claw down to grab an item.

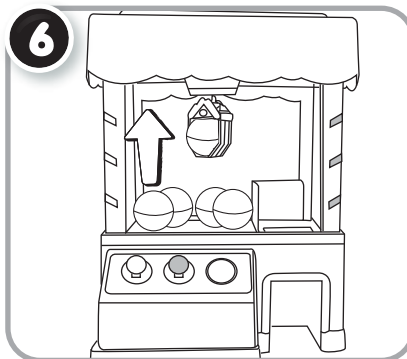

Bring the claw up to pick up the item.

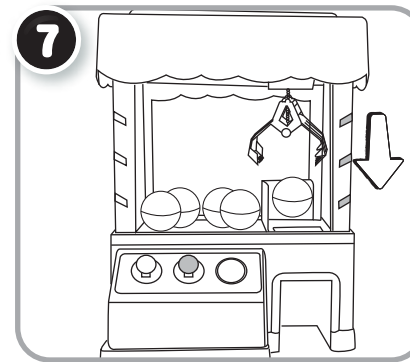

Move the claw over the chute, and bring the claw down to release the item into the opening.

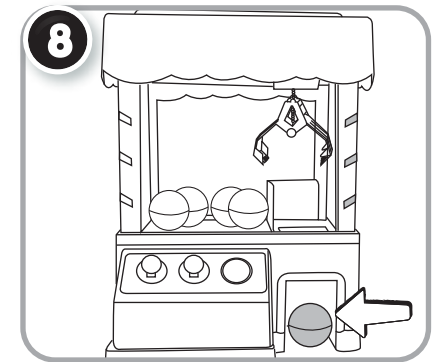

Grab your prize!

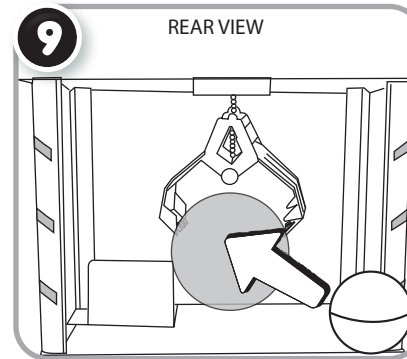

Refill the machine through the opening on the back of the unit. DO NOT OVERFILL.

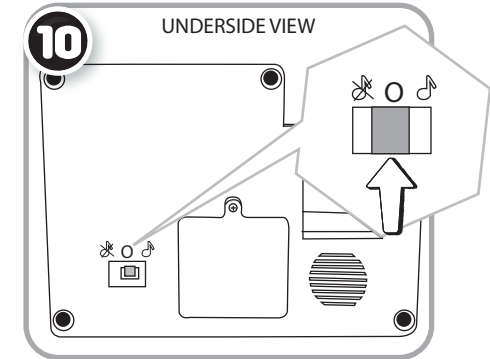

Always turn the machine OFF (O) after playing to conserve battery power.

DOLL STAND

(Stand not included with pet.)

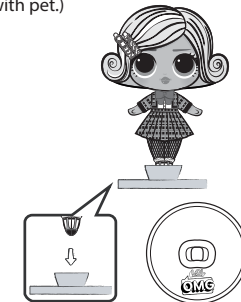
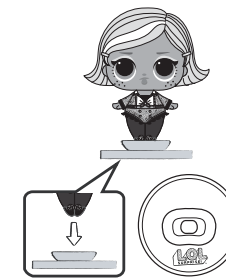

IMPORTANT INFORMATION

- **CAUTION!** Do not place your hand or fingers into the opening on the back when refilling. Do not interfere with the claw while it is moving or it will disable its mechanism and stop functioning.
- When refilling, keep the claw away from the opening to prevent damage to the unit.
- Do not overfill the machine. The claw needs room to freely move around.
- The claw machine will go to sleep after 70 seconds. Press the button on the front of the machine to start it up again.

⚠️ WARNING:

This toy produces flashes that may trigger epilepsy in sensitized individuals.