

LMX24-SR-T Technical Data Sheet

Modulating, Non-Spring Return, 24 V, for DC 2...10 V or 4...20 mA



| Technical Data | |
|------------------------------------|---|
| Power Supply | 24 VAC, ±20%, 50/60 Hz, 24 VDC, ±10% |
| Power consumption in operation | 1.5 W |
| Power consumption in rest position | 0.4 W |
| Transformer sizing | 3 VA (class 2 power source) |
| Shaft Diameter | 1/4...5/8" round, centers on 5/8", 3/4" clamp available |
| Electrical Connection | Screw terminal (for 26 to 14 GA wire) |
| Overload Protection | electronic throughout 0...95° rotation |
| Operating Range | 2...10 V, 4...20 mA w/ ZG-R01 (500 Ω, 1/4 W resistor) |
| Input Impedance | 100 kΩ (0.1 mA), 500 Ω |
| Angle of rotation | Max. 95°, adjustable with mechanical stop |
| Torque motor | 45 in-lb [5 Nm] |
| Direction of motion motor | selectable with switch 0/1 |
| Position indication | Mechanically, 30...65 mm stroke |
| Manual override | external push button |
| Running Time (Motor) | 95 s, constant, independent of load |
| Ambient humidity | max. 95% r.H., non-condensing |
| Ambient temperature | -22...122°F [-30...50°C] |
| Storage temperature | -40...176°F [-40...80°C] |
| Degree of Protection | IP20, NEMA 1, UL Enclosure Type 1 |
| Housing material | UL94-5VA |
| Agency Listing | cULus acc. to UL60730-1A/-2-14, CAN/CSA E60730-1:02, CE acc. to 2014/30/EU and 2014/35/EU |
| Noise level, motor | 35 dB(A) |
| Servicing | maintenance-free |
| Quality Standard | ISO 9001 |
| Weight | 0.62 lb [0.28 kg] |

Torque min. 45 in-lb, for control of damper surfaces up to 11 sq. ft.

Application

For On/Off and floating point control of dampers in HVAC systems. Actuator sizing should be done in accordance with the damper manufacturer's specifications.

The actuator is mounted directly to a damper shaft from 1/4" up to 5/8" in diameter by means of its standard universal clamp. Shafts up to 3/4" diameter can be accommodated by an accessory clamp.

Operation

The actuator is not provided with and does not require any limit switches, but is electronically protected against overload. The anti-rotation strap supplied with the actuator will prevent lateral movement.

The LMB series provides 95° of rotation and a visual indicator indicates position of the actuator. When reaching the damper or actuator end position, the actuator automatically stops. The gears can be manually disengaged with a button on the actuator cover.

The LMB24-SR... actuators use a sensorless brushless DC motor, which is controlled by an Application Specific Integrated Circuit (ASIC). The ASIC monitors and controls the actuator's rotation and provides a digital rotation sensing (DRS) function to prevent damage to the actuator in a stall condition. Power consumption is reduced in holding mode.

Add-on auxiliary switches or feedback potentiometers are easily fastened directly onto the actuator body for signaling and switching functions.

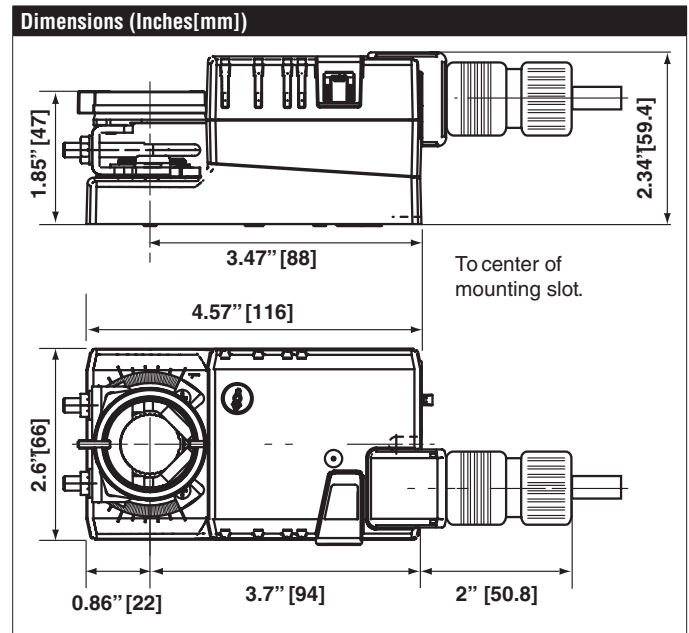







Date created, 02/10/2020 - Subject to change. © Belimo Aircontrols (USA), Inc.

Typical Specification

Proportional control damper actuators shall be electronic direct-coupled type, which require no crank arm and linkage and be capable of direct mounting to a shaft from 1/4" to 5/8" diameter. Actuators must provide control in response to a control input from an electronic controller or positioner. Actuators shall have brushless DC motor technology and be protected from overload at all angles of rotation. Actuators shall have reversing switch and manual override on the cover. Run time shall be constant and independent of torque. Actuators shall be cULus listed, have a 5-year warranty, and be manufactured under ISO 9001 International Quality Control Standards. Actuators shall be as manufactured by Belimo.

Wiring Diagrams

-  Provide overload protection and disconnect as required.
-  Actuators may also be powered by 24 VDC.
-  Only connect common to negative (-) leg of control circuits.
-  A 500 Ω resistor (ZG-R01) converts the 4 to 20 mA control signal to 2 to 10 VDC.
-  Actuators may be connected in parallel if not mechanically linked. Power consumption and input impedance must be observed.
-  Actuators are provided with a numbered screw terminal strip instead of a cable.

