

B320-490-290 Technical Data Sheet

Chrome Plated Brass Ball and Nickel Plated Stem, 3/4", NPT Female Ends

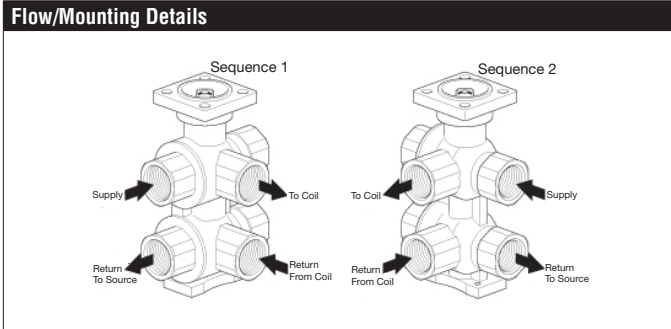

Technical Data	
Fluid	chilled or hot water, up to 60% glycol
Flow characteristic	linear
Controllable flow range	sequence 1 (angle 0...30°), dead zone (30...60°), sequence 2 (angle 60...90°)
Valve Size [mm]	0.75" [20]
Pipe connection	NPT female ends
Housing	Nickel-plated brass body
Ball	chrome plated brass
Stem	nickel-plated brass
Stem seal	EPDM (lubricated)
Seat	PTFE
O-ring	EPDM
Characterized disc	chrome plated steel
Body Pressure Rating	230 psi
Close-off pressure Δps	50 psi
Weight	4.6 lb [2.1 kg]
Fluid Temp Range (water)	43...180°F [6...82°C]
Leakage rate	0%
Seq 1 Cv	4
Seq 2 Cv	2.9
Servicing	maintenance-free



Application

The 6-way characterized control valve is ideal for chilled beams, radiant ceilings, and fan coil units offering reduced wiring by using a single actuator instead of two. It eliminates the need for a change-over valve and enables the use of a single coil for heating and cooling.

Operation

A loop pressure relief is designed into port number two (2). This allows the increased pressure to dissipate to the supply loop on port number one (1). This is intended to release any pressure build up in the loop (coil) when the valve is in the closed position and is isolated from the system expansion vessel. The change in pressure occurs due to a change in the media temperature in the coil while isolated from the pressure vessel. The pressure relief does not affect the efficiency of the system because cross-flow cannot occur between the heating and cooling loops. The system loops (heating/cooling) should share a common expansion vessel to keep the system pressure and volume balanced.

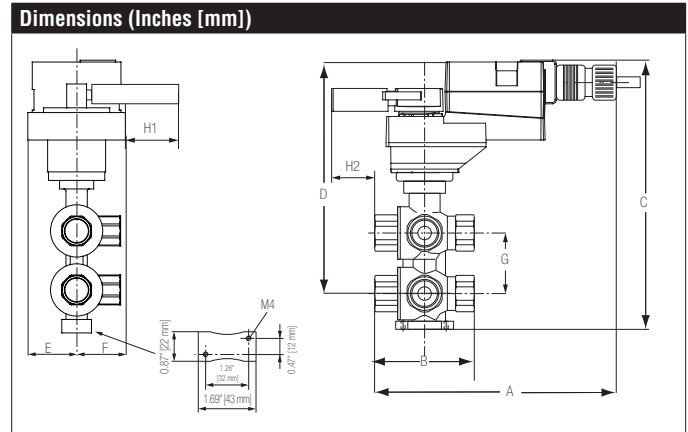

A	B	C	D	E	F	G	H1	H2
7.5"	3.9"	9.0"	7.6"	2.0" [51]		2.4"	1.2"	0.6"
[191]	[100]	[229]	[194]			[60]	[30]	[15]

Application Notes

If assembled with a MFT actuator, it must be programmed for proportional control only.

The control valve can be mounted either vertically or horizontally. Do not install the valve with the stem pointing downwards.

A single expansion tank is recommended to ensure same pressure on the heating and cooling loops, this helps to maintain energy efficiency by eliminating migration of water from the cooling to the heating loop.

Maintenance: 6-Way characterized control valves and rotary actuators are maintenance-free.

Before any kind of service work is carried out, it is essential to isolate the actuator from the power supply (by disconnecting the power).

LRB24-SR Technical Data Sheet

Modulating, Non-Spring Return, 24 V, for DC 2...10 V or 4...20 mA



5-year warranty



Technical Data	
Power Supply	24 VAC, ±20%, 50/60 Hz, 24 VDC, ±10%
Power consumption in operation	1.5 W
Power consumption in rest position	0.4 W
Transformer sizing	3 VA (class 2 power source)
Electrical Connection	18 GA plenum cable, 3 ft [1 m], with 1/2" conduit connector
Overload Protection	electronic throughout 0...90° rotation
Operating Range	2...10 V, 4...20 mA w/ ZG-R01 (500 Ω, 1/4 W resistor)
Input Impedance	100 kΩ for 2...10 V (0.1 mA), 500 Ω for 4...20 mA
Position Feedback	2...10 V
Angle of rotation	90°
Direction of motion motor	selectable with switch 0/1
Position indication	Mechanically, pluggable
Manual override	external push button
Running Time (Motor)	90 s
Ambient humidity	max. 95% r.H., non-condensing
Ambient temperature	-22...122°F [-30...50°C]
Storage temperature	-40...176°F [-40...80°C]
Degree of Protection	IP54, NEMA 2, UL Enclosure Type 2
Agency Listing	cULus acc. to UL60730-1A/-2-14, CAN/CSA E60730-1:02, CE acc. to 2014/30/EU
Noise level, motor	35 dB(A)
Servicing	maintenance-free
Quality Standard	ISO 9001
Weight	1.1 lb [0.50 kg]

†Rated Impulse Voltage 800V, Type action 1.B, Control Pollution Degree 3.

Date created, 04/03/2020 - Subject to change. © Belimo Aircontrols (USA), Inc.

Wiring Diagrams

✂️ INSTALLATION NOTES

- ⚠️ 1 Provide overload protection and disconnect as required.
- ⚠️ 2 Actuators may be connected in parallel. Power consumption and input impedance must be observed.
- ⚠️ 3 Actuators may also be powered by 24 VDC.
- ⚠️ 5 Only connect common to negative (-) leg of control circuits.
- ⚠️ 7 A 500 Ω resistor (ZG-R01) converts the 4 to 20 mA control signal to 2 to 10 VDC.
- ⚠️ 18 Actuators with plenum cable do not have numbers; use color codes instead.
- ◆ Meets cULus requirements without the need of an electrical ground connection.

⚠️ WARNING! LIVE ELECTRICAL COMPONENTS!
 During installation, testing, servicing and troubleshooting of this product, it may be necessary to work with live electrical components. Have a qualified licensed electrician or other individual who has been properly trained in handling live electrical components perform these tasks. Failure to follow all electrical safety precautions when exposed to live electrical components could result in death or serious injury.

