

AOFAR[®]

GOLF RANGEFINDERS

GX-2S

AOFAR BRAND CUSTOMER SERVICE SUPPORT: service@aofar.com

- English manual-----Contact us: service@aofar.com
- Manuel en français ----- Contactez-nous: service@aofar.com
- Deutsches Handbuch ----- Kontaktieren Sie uns: service@aofar.com
- Manuale in italiano ----- Contattaci: service@aofar.com
- Manual en español ----- Contáctenos: service@aofar.com
- Manual em português ----- Contate-nos: service@aofar.com
- Nederlandse handleiding ----- Neem contact met ons op: service@aofar.com
- 日本語マニュアル ----- お問い合わせ: service@aofar.com

TABLE OF CONTENTS

1.	TABLE OF CONTENTS	3
2.	OPERATION INSTRUCTIONS	4
	Focus adjustment; Units switch; Slope switch function; Range mode; Scan mode; Flag lock mode	
3.	PRODUCT SPECIFICATIONS	7
4.	DESCRIPTION OF THE SCREEN DISPLAY	8
5.	COMPONENTS NAME	9
6.	HOW TO WORK AND RANGING ACCURACY	10
7.	RAEDY TO START (Inserting the battery)	11
8.	GOLF MODE EXAMPLE	12
9.	LIST OF ARTICLES	14
10	USE SAFETY INSTRUCTIONS	15
11	PRECAUTIONS OF LITHIUM BATTERY	17
12	MAINTENANCE OF THE INSTRUMENT	17
13	TROUBLE SHOOTING TABLE	18
14	CUSTOMER SERVICE/WARRANT	19

2.OPERATION INSTRUCTIONS

Focus adjustment

Rotating the eyepiece until the reticle and object display to your eye clearly.

GX-2S range finder is constructed with an adjustable eyepiece (+/-3 Diopter). People with different visions don't need to wear glasses, they can observe LCD with naked eyes.



Units switch

To select yard and meter, just press and release "M" button quickly to change "Y"(yard) and "m" (meter).

The GX-2S range finder can be used to measure distances in yard or meter. The unit of measure indicators are located in the lower right portion of the LCD.

Slope switch function

Pressing "M" button that is units switching button and hold it for approximately 3 seconds. The data displayed at the top will disappear, leaving only a straight line distance on the LCD, which is designed for golf games. If you want to turn on the slope mode, just press the "M" button again for 3 seconds.

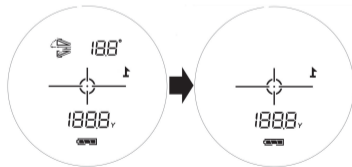

Range mode

1. Look at LCD through the eyepiece, then press Power button and release quickly, you will see the display as right picture. Pressing Power button again to measure.

(The laser rangefinder will auto power-off if no operation within 8 seconds.)

2. Placing the aiming circle (located in the center of view) on a target over than 6 yards away, press Power button and release quickly. The range and angle, slope reading will be displayed on LCD.

LCD data shows: Line of sight distance until auto power-off.

(Straight-line distance is 20.82 yards, angle is 4.9 degrees, and slope is 22 yards.)

For the slope of uphill / downhill slope. Please refer to Page 12 "GOLF MODE EXAMPLE".

3. **Tips:** When the target's background is single or the target is large, just need use RANGE MODE that click the "Power button to measure"; When the target background is complicated or it is difficult to measure the distance by clicking Power button, you can use SCAN MODE/FLAG LOCK MODE.

4. **Tips:** SCAN MODE/FLAG LOCK MODE is recommended when measuring the flag on golf courses.

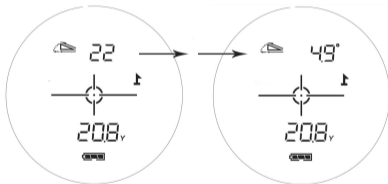

Scan mode (WITHOUT PULSE VIBRATION HAPPEN)

Long press the “POWER” button align flag to scan, you will get distance without pulse feeling.

Flag lock mode (WITH PULSE VIBRATION HAPPEN)

Flag lock mode sign  : After you lock onto flag successfully, the circle on flag sign will shows. (Like image shows)









Method: Pressing “POWER” button and scan from far to flag, at the same time, the “Scan” icon will flash and the circle on the flag will show , you will get distance and feel vibration.



3.PRODUCT SPECIFICATIONS

Model	GX-2S
Size	121 x 72 x 43mm
Weight	191g
Battery	CR2-3V
Measurement range	6 ~ 600 Y
Measurement deviation	± 1 Y
Magnification	6 Times
Objective diameter	25mm
Eyepiece diameter	16mm
Exit pupil diameter	3.5mm
Laser wavelength	905nm
Laser type	Class I
Diopter	±3°
Operating temperature	-10~50℃
Storage temperature	-20~60℃
IP Rating	IPX4 waterproof

4.DESCRPTION OF THE SCREEN DISPLAY

		Uphill display: The target is uphill
		Downhill display: The target is downhill
		Display order: slope, angle then slope
		Lock mode sign : Icon change comparison
		Battery indicator
		Target marker: Please superimpose the center circle with target object to be measured
		Measuring distance: Straight-line distance
		Distance unit display: The distance unit at your option

5.COMPONENTS NAME

- ① Laser Transmitting Objective Lens
- ② Laser Receiving Objective Lens
- ③ Units Switching Button/ "M" button (m: Meter/Y: Yard)
- ④ Power/Reading Button
- ⑤ Rotary Focusing
- ⑥ Observing Eye lens/LCD (Liquid crystal display)
- ⑦ Battery Cap
- ⑧ Sling Connecting Hole

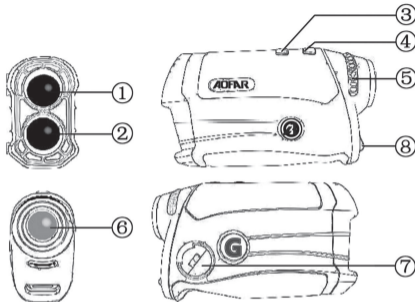

6.HOW TO WORK AND RANGING ACCURACY

The GX-2S range finder emits invisible, eye safe, infrared energy pulses. Sophisticated digital technology instantaneously calculates distances by measuring the time, which it takes for each pulse to travel from the rangefinder to the target and back to rangefinder.

The color, surface smoothness, size and sharpness of target will affect its reflectivity and range.

It is difficult to test in the following conditions and environments:

Raining or fogging / Target is too small / Low reflectivity of the measured object (dark color, complex shape, curved surface, water surface, glass surface, mirror surface. etc.) / Low battery.

7. RAEDY TO START

- Remove the battery cap by rotating the cap counter-clockwise.
- Insert a CR2-3V battery.
- Put the negative pole of lithium battery into battery compartment first.
- Replace the battery cap.



Note: It is recommended that the battery should be replaced once every 12 months.

Notice: Replace the battery when Low battery indicator shows.

If the “” displays and flash on LCD, which means “low battery”. **It can be turned on, but it can't shows any data. Meanwhile, vibration will be paused.**

Install/Change battery

1. Open the cap counter-clockwise
2. The positive pole "+" of the lithium battery CR2 should be placed outwards. (look at the picture)
3. Tightening the battery cap clockwise after installing the battery.

Display	Description
	Sufficient power available
	60% power left.
	Low battery indicator flash: Replace the battery now! *It can be turned on, but it can't shows any data. Meanwhile, vibration will be paused.

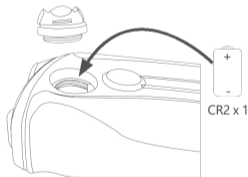

8.GOLF MODE EXAMPLE

Distance measurement of ascending slope: Slope is farther than the straight-line distance.

Distance between AB points=distance between AD points in a straight-line 99.71Y. Hit the ball in accordance with the distance measured with the strike parabola 1, the angle of slope is $+6.2^\circ$, and the ball will arrive at the point C. To reach the point B, the trajectory of the ball needs to follow the parabola 2. The actual hitting distance at this time is the straight-line distance between point A and point E, i.e. 108Y.

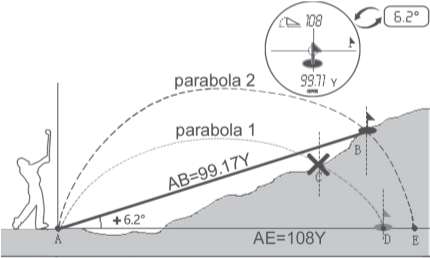

Distance measurement of downward slope: Slope is less than the straight-line distance.

Distance between AB points = distance between AD points in a straight-line 216.01Y. Hit the ball in accordance with the measured distance with the strike parabola 2, the angle of slope is -12.1° , the ball will arrive at the point C. To reach the point B, the trajectory of the ball needs to follow the parabola 1. The actual hitting distance at this time is the straight-line distance between point A and point E, i.e. 170Y.

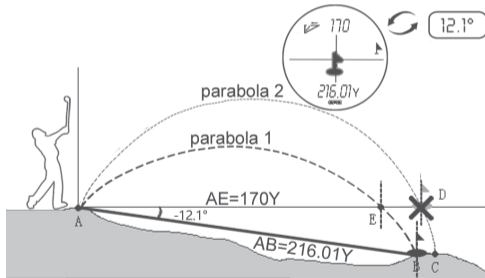

9.LIST OF ARTICLES

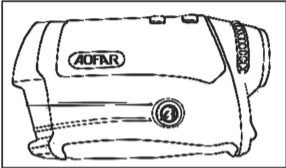
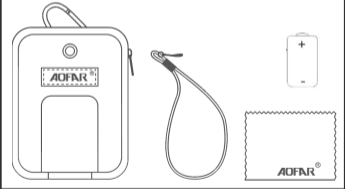
	<p style="text-align: center;">AOFAR[®] GOLF RANGEFINDERS</p> <p style="text-align: center; background-color: black; color: white; padding: 5px;">GX-2S</p>
<p style="text-align: center;">Laser Rangefinder</p>	<p style="text-align: center;">Instruction Manual</p>
	
<p style="text-align: center;">Handbag, lanyard, cleaning cloth, battery and carabiner</p>	

10. USE SAFETY INSTRUCTIONS

- Preventing your instrument from falling or getting damaged and never tamper it. If there is abnormal noise, please contact customer service department of our company.
- The operating temperature for this product is $-10\text{ }^{\circ}\text{C}\sim 50\text{ }^{\circ}\text{C}$. Please use or keep the instrument within the operating temperature range and avoid using in a sharp temperature change environment.
- Please do not keep the product under the sunlight directly, high temperature or low temperature environment for a long time. (e.g. in trunk of car).
- Do not expose and aim at the sunlight.
- Do not use or store the product in the environment with strong electromagnetic radiation or magnetic field.
- If the product isn't be in use for a long time, please remove the battery and store it in a cool, dry place. It is also recommended to put this product in a dry box.
- Do not disassemble, modify or repair the product by yourself, the damage of the instrument and the irradiation of the laser may cause the visual damage and other harm.
- Please do not use it in dusty areas in order to avoid failures.
- Although the product has waterproof function, please do not get it wet or immersed in water intentionally. When there is moisture around the button, please operate it after wiping it off, and do not use it in water.
- Please confirm that the battery cover is closed tight when it be used.

Warning!

- Do not look at the Laser Transmitting Objective Lens ①.
- Do not measure eyes of others.
- It is forbidden to detach this product yourself.
- It should be kept out of reach of the children.

Attention!

- It is normal for lens to be wet when the temperature changes suddenly. In this situation, remove the battery and do not use the device until it becomes dry.
- Moving from a cold place to a hot room of the product may dew on the appearance and internal parts. To avoid this phenomenon, please put the device in a waterproof plastic bag and take it out after its temperature has gradually increased.
- To avoid failures ,do not store the product in :
 1. Unventilated and humid places
 2. The car or trunk exposed to the sun
 3. Environment with humidity over 90%

※**Please don't preserve or place the lens under the sun!**

It's radiation convergence function can harm the LCD

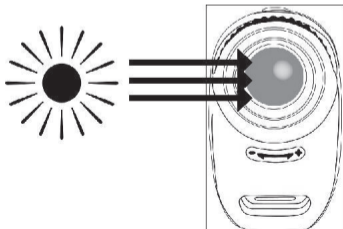

11.PRECAUTIONS OF LITHIUM BATTERY

- To prevent leakage, heat and fire, etc.
 - Do not disassemble and modify the product by yourself.
 - Do not throw it into fire or store it in high temperature.
 - Avoid direct contact with metal objects such as coins or keys (in a pocket or bag).
- If skin touch the leaked liquid accidentally, please rinse under cool water immediately. If eyes or mouth touch liquid leaking, do not rub. Rinse under cool water and consult a doctor.
- It must be kept out of reach of children.
- Observe treatment methods in your native policy when dropping a used lithium battery.

12.MAINTENANCE OF THE INSTRUMENT

Gently wipe the surface of lens with a clean, soft cloth to remove stains which would damage it.

If there are stains on the surface of the lens, which may damage lens. Do not touch the lens with your finger to protect the coating from the appearance.

13. TROUBLE SHOOTING TABLE

If LCD can't be turned on:

- Pressing Power button again.
- Check battery or replace it if necessary. (Determine if there is an insulator blocking the battery power)

If Distance measurement is abnormal:

- Please confirm whether the lens have dirt.
- Please make sure that the mark circle overlap your target.

It can be turned on, but the data will not be displayed:

- Low battery voltage, please change the battery.
- Out of measurement range or less than 5 yards.
- Change the measurement target.

Measurement error:

- M/Y is not switched.
- Rain and fog and small target will also affect the measurement results.

Battery power runs out quickly:

- Low ambient temperature will cause the battery power runs out quickly.
- If the battery has not been used for a long time after unpacked, the battery power will run out quickly.

14.CUSTOMER SERVICE/WARRANT

Customer service:

Website : www.aofar.com

Customer service: service@aofar.com

Facebook: Aofar Us

AOFAR focuses on the research and development of outdoor products especially in range finder and compass, AOFAR has first-class production technology and R&D experts. Nowadays, our products are sold all over the world and very popular. We dedicate to improve customers' outdoor life by rich experience and expertise.

Warranty

The product warranty period is two years from the date of purchase.

- Please take a few minutes to register your product at www.aofar.com/account/register
- In the event of a need for service or repair, please contact AOFAR Product Service at: service@aofar.com
- For product questions, consult the AOFAR Website at: www.aofar.com or contact Customer service: service@aofar.com

Our customer service will reply you within 24 hours after receiving your message.

**AOFAR UK
CA**

Name:Range Finder	Manufacture Date: 2022
Model: GX-2S	Serial Number: 2561801000
Company Name: CHANGZHOU JIANFU OPTOELECTRONIC INSTRUMENT CO.,LTD.	
Address: No.2,Building 18, Chuangzhi Yungu,No.186 Hongxi Road Niutang Town, Wujin District,Changzhou City,Jiangsu,China	

AOFAR

www.aofar.com