

1

FENDT

Front loader

Fendt CARGO



The Fendt CARGO front loader

The combination is unbeatable

The Fendt front loader – Fendt CARGO – offers sophisticated technology for maximum productivity. As a reliable universal implement, it is the ideal partner for all Vario tractors. All models are equipped with the unique CARGO Lock coupling system and parallel guidance with Z-kinematics. Whether for everyday farming work, toughest contracting jobs or intensive municipal operations, the new Fendt CARGO proves its high performance capabilities in all applications.

Cargo 3 X / 65	200 V / 300 V
Cargo 3 X / 70	300 V
Cargo 4 X / 75	300 V / 400V
Cargo 4 X / 80	400 V
Cargo 4 X / 85	700 V *
Cargo 5 X / 85	700 V
Cargo 5 X / 90	700 V

* up to 28-inch wheels



Perfectly tailored to your Vario

A unit designed for quality

The basic prerequisite for all Fendt developments is high quality. A major objective during the development of the CARGO was to build a perfect unit with the tractor. The technical specifications and overall design of the tractor and front loader have been optimally adapted to each other.

Z-bar linkage

Further evidence that the front loader is perfect adapted to all the Vario tractors is the tried and tested mechanical self-levelling function on the CARGO, in the form of Z-bar linkage. It guarantees the best visibility. The parallel guidance ensures that attachments are kept in the same position over the entire lifting height. You can monitor its position at all times with the tilt indicator.

Lifetime design

High-grade materials ensure durability for a long service life. High-strength fine-grain steel is the key factor behind the life-time design of the new Fendt CARGO. In addition to high stability, this also guarantees a low weight. The Fendt profile, which is welded in one continuous seam, ensures high stability and therefore a long service-life. The generously sized bearing points also guarantee high durability and minimum wear.

Optimum technology for the Vario

The use of modern design processes when developing the CARGO allowed it to be tailored perfectly to the Vario tractors. The wide arm and the far forward location of the cross beam ensure optimum visibility.

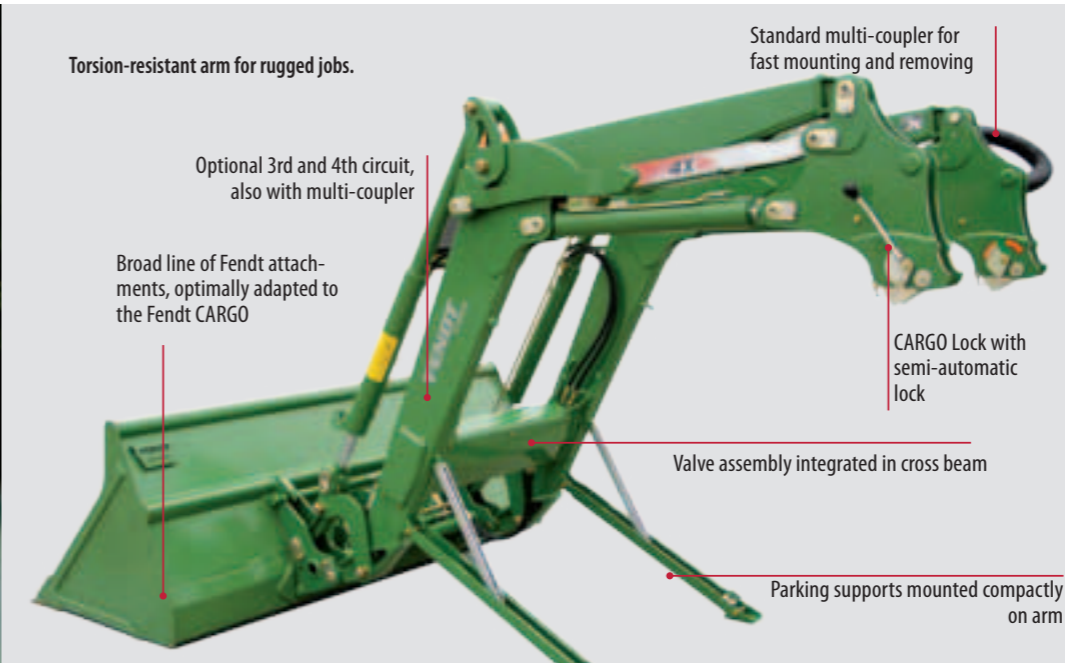

- Vario and CARGO form one exceptional unit
- Perfect visibility
- Life-time design for a long service life
- Sophisticated self-levelling through Z-bar linkage
- Developed using state-of-the-art 3D CAD



Mechanical self-levelling – compact design through Z-bar linkage

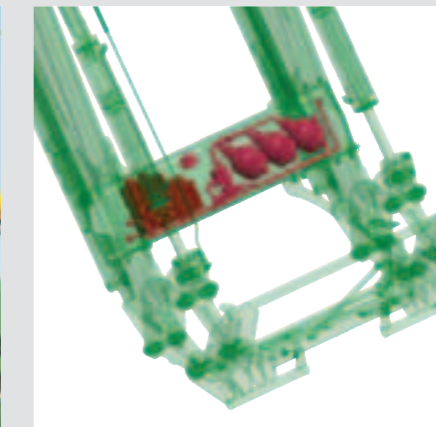

All hydraulic components are fitted in the cross beam and are therefore optimally protected from direct and mechanical damage.

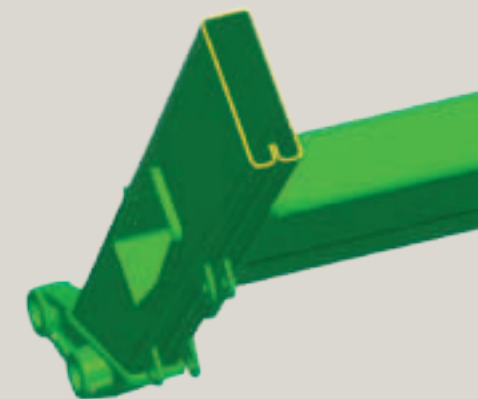

Fendt metal profiles are made of high-strength fine-grained steel with precise welded seams.

Mounting and removing made easy

Technology for fast mounting and removing

The new Fendt CARGO Lock makes mounting and removing the loader easy and fast. The multi-coupler also saves time. It permits trouble-free connection of all electric and hydraulic lines with just one hand movement.

CARGO Lock

The CARGO Lock semi-automatic locking system does away with having to insert locking pins, which is often difficult. This really simplifies mounting and removing. An indicator on the inside of the loader towers permits the driver to view the status of the locking system at all times from the driver seat.

Multi-coupler

Just one hand movement is all it takes to connect the hydraulic and electric lines. With the standard-equipped multi-coupler, incorrectly connected hoses, oil contamination and high leakage losses are a thing of the past. Disconnecting is equally easy and just as clean. The CARGO can be coupled without problems, even when there is excess pressure in the loader, for example, because it was standing out in the sun.

Perfect stand

The parking supports have been completely redesigned. Manual setting and adjusting is not necessary, which saves valuable working time. Bolts or cotter pins no longer need to be inserted. The self-adjusting parking supports are mounted compactly on the arm.

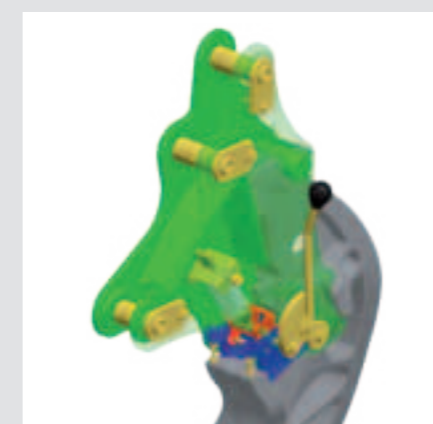

Fendt CARGO Lock: fast, easy mounting and removing guaranteed.

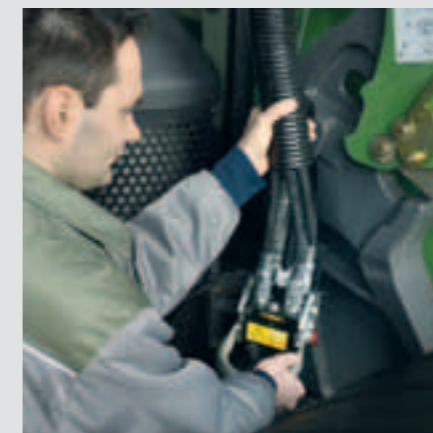

A multi-coupler connects all hydraulic and electric lines at once – even under pressure on the front loader side.



The self-adjusting parking supports are mounted compactly on the arm.

- CARGO Lock automatic attachment lock
- Maintenance-free mounting system
- Multi-coupler for mounting and removing the front loader is standard
- Parking supports mounted compactly on arm

The finest operating and driving comfort

Fully integrated operation

The Fendt CARGO front loader is designed for exceptional driving comfort. The optional damping system protects your front loader, your tractor and, most importantly, your health. Thanks to sophisticated detail solutions, maximum visibility also contributes to a high degree of driving comfort.



Perform daily work comfortably

Comfortable working conditions

The damping system, which lies completely protected in the cross beam, provides exceptional comfort. Gas pressure reservoirs on the front loader act as shock absorbers. Shock loads cause the hydraulic oil to press against a membrane in the gas pressure reservoir. This compresses the gas volume, which reliably reduces peak loads. If precise implement control is required, the system can be switched off electrically, with a quick push of a button in the cab.

Ideal suspension

The combination of front loader damping, front axle suspension and cab suspension is part of a well-thought out and ideally adapted suspension design. The system guarantees excellent ride comfort and fatigue-free work in uneven terrain and at high travel speeds.

Best visibility

The mounting points of the front loader arm and the Z-bar linkage permit the front window to be swung out fully at any time during front loader work (not 3X/65). A wide arm and a crossbeam that is located at the far front, ensure an unobstructed view. The roof window in the Fendt Vario, standard on the 200 Vario, provides improved visibility. The front windscreen on the new 700 Vario curves up into the roof at the top and provides optimised visibility.



Front loader without damping system:
shock loads are transmitted to the tractor.

Front loader with damping system:
gas pressure reservoirs act as shock absorbers and prevent vibrations from being transmitted to the tractor body.
The integral damping system (1), together with front axle suspension (2) and cab suspension (3), ensures superior ride comfort (optional).



The roof window, which is standard on the 200 Vario and optional for the 300 Vario, provides an optimum view to the raised front loader.

- Maximum ride comfort through integral damping system (optional, not available for the 3X/65, 3X/70)

- Gas shock absorbers and valves lie protected in cross beam

- Fast and easy access to all components

- Damping system electrically engaged and disengaged from the cab

- Optimised visibility for all front loader work



Long reach and high lifting height

A long reach combined with a high lifting height optimises loading of transport vehicles.

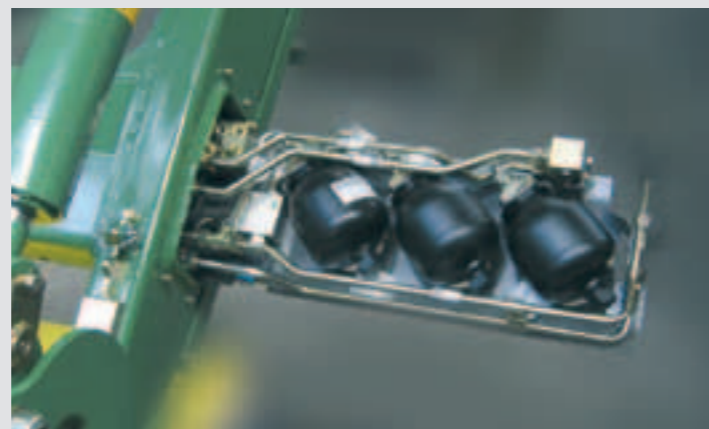

The innovative cross beam offers many benefits:

it optimises visibility and completely protects the hydraulic lines and valves, and guarantees easy access for retrofitting or service work.



The new 700 Vario is fitted with the VisioPlus cab, which features a front windscreen that curves up into the roof. It triples the upward viewing angle and provides a full view of the front loader, even when it is fully raised. The downward sight lines have also been optimised and provide an excellent view to the wheel arches.

Maximum comfort for better performance

Sensitive and precise

You will be thrilled by how easy the front loader is to operate, because it is perfectly integrated in the Fendt Vario. Two control valves can be controlled very precisely with the standard crossgate lever without having to reposition the hand.

CARGO comfort controls

Complex implement functions can be controlled with the optional third and fourth hydraulic circuits. These are activated and controlled by pushbuttons on the crossgate lever. The optional hydraulic attachment lock and the vibration damping system (optional) can also be conveniently operated from the driver seat.

Fast and easy direction changing

The rapid reverse function on your Vario allows you to change driving direction quickly and easily, without wear. When driving in pedal mode with TMS, both of your hands are free, allowing you to change travel direction with your left hand and control the CARGO with your right.



With the reverser lever, changing directions is easily done with the left hand. When the lever is pressed, the Vario stands still. When the lever is released, the tractor automatically drives in the preselected direction.



Operators can lock and unlock the attachment hydraulically with a pushbutton in the cab, so frequent attachment changes can be performed quickly, without climbing out of the cab. Two locking indicators allow operators to see if the attachment is locked on both sides (not for 3X arm).



The standard-equipped crossgate lever controls the front loader very precisely via two control valves. When working with a silage or bale grab, the third and fourth hydraulic circuit (optional) can be actuated with the pushbuttons on the crossgate lever.



With the Cargo comfort controls, the third circuit can be switched over to control the hydraulic attachment lock and the fourth circuit to control the optional damping system.



Fine adjustments can be made to the valve functions using the Varioterminal. For example, you can control the flow rate precisely and easily using the rotary controls and function keys.



The arrangement of the operating elements ensures optimum ergonomics. The Varioterminal gives you a clear overview of all control displays.

- Sensitive and precise front loader operation with crossgate lever
- Easy control of the third and fourth hydraulic circuits (optional) using the buttons on the crossgate lever
- Precise setting of valve functions via the Varioterminal
- Hydraulic attachment lock for fast attachment changes is optional (not for 3X arm)
- Ergonomic and easy reversing with the left hand
- Speed control with the driving pedal and easy front loader control with the right hand

Maintenance – fast and easy

Perfection in design

Since the designs of the front loader and the tractor have been specially adapted to each other from the very beginning, all maintenance work can be performed while the front loader is mounted. The front loader was designed to guarantee a very long service life through simple maintenance requirements and the use of the best materials.

Robust and hard-wearing

Maintenance and service-friendliness played an important role when developing the Fendt CARGO. The bearing points are large, which makes them exceptionally robust and guarantees a very long service life

Flexible ballasting

Fendt offers you a comprehensive ballasting concept for frequent loader work. Wheel weights or rear weights, which are fast and easy to mount and remove, can be used, depending on the application. So your Vario always remains balanced.



The large-sized bearing points ensure play-free connections, durability and a minimum of wear. The bushes are made of high-grade bronze bearing material and have lubrication pockets.



The front loader mounting parts have been designed specifically for the Vario tractors, so all maintenance points are accessible, even when the front loader is mounted. For example, access to the oil dipstick was taken into account when designing the mounting brackets.



Wheel weights are available for optimum rear ballasting. They are mounted with the tried and proven Fendt coupling system.



Universal weights round off the ballasting system perfectly.

- Best access to all maintenance points on the tractor
- Simple and fast maintenance on the front loader
- Large-sized bearing sleeves
- Protected, easily accessible lubrication nipples
- Flexible ballasting at the rear

Back-end loader lifts higher

The solution for high-horsepower tractors

Fendt offers a special solution for loader work with the 800 and 900 Vario: the Cargo R. This back-end loader expands the range of applications possible for high-horsepower tractors. For example, in addition to transport work, high-horsepower tractors can be used to fill biogas facilities.

The technical advantages of the Cargo R

The advantages of the exceptional design are plain to see. Operators benefit from the outstanding view to the back-end loader. The rear wheel steering system makes steering corrections and very precise loading much easier, so that the Cargo R takes on the loading characteristics of a telehandler. An impressive loading height of up to 5.05 metres, a loading reach of 1.90 metres and a lift capacity of some 3 tonnes speak for themselves.

And this is how easy it is to use

The 4X/85 arm is attached to a bracket on the rear lift. The operator station is turned all the way around to the rear with the practical reversing driver station. The operating elements are located on the right-hand armrest, as accustomed, and adjustments are easily made with the crossgate lever and the toggle switches.



- Loader work is possible with the Fendt 800/900 Vario high-horsepower tractors thanks to Cargo R

- All operating elements at hand with practical reverse drive mode (optional)

- Ideal view to the back-end loader

- Precise steering corrections through rear wheel steering

- Loading height of up to 5.05 meters

- Loading reach of 1.90 metres ensures fewer passes over the material to be loaded

- Lift capacity of up to four tonnes



Console for mounting the Fendt Cargo R back-end loader.

Technical specifications Cargo R

Max. lift capacity	3,000 daN
Max. lift height ¹⁾	5,05 m
Max. lift height ²⁾	4,12 m
Loading reach ³⁾	1,90 m

1) lower links raised
2) lower links horizontal
3) at 3.50 m lifting height

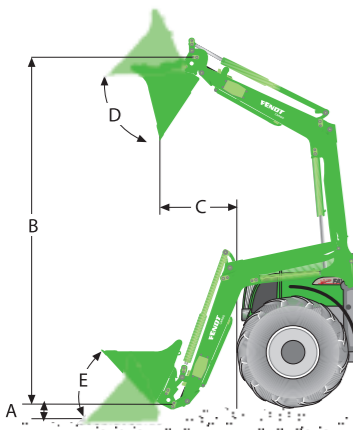

A Digging depth (mm)
 B Lifting height (mm)
 C Dumping distance (mm)
 D Angle of emptying 55°
 E Angle of backwards tilt 48°

Front loader model	3X/65	3X/70 ²⁾	4X/75	4X/80	4X/85 ³⁾	5X/85	5X/90
Range 200 V							
continuous Lift capacity daN	1680						
max. lift capacity daN	1850						
Lifting height mm ¹⁾	3740						
Digging depth mm ¹⁾	210						
Dumping dist. (at max. hght) ¹⁾	860						
Dumping distance (at 3.5 m) ¹⁾	1170						

Front loader model	3X/65	3X/70 ²⁾	4X/75	4X/80	4X/85 ³⁾	5X/85	5X/90
Range 300 V							
continuous Lift capacity daN	1680	2000	1940				
max. lift capacity daN	1850	2190	2250				
Lifting height mm ¹⁾	3850	3900	4050				
Digging depth mm ¹⁾	110	60	225				
Dumping dist. (at max. hght) ¹⁾	930	1030	1260				
Dumping distance (at 3.5 m) ¹⁾	1350	1450	1780				

Front loader model	3X/65	3X/70 ²⁾	4X/75	4X/80	4X/85 ³⁾	5X/85	5X/90
Range 400 V							
continuous Lift capacity daN			1940	2260			
max. lift capacity daN			2250	2620			
Lifting height mm ¹⁾			4125	4125			
Digging depth mm ¹⁾			180	180			
Dumping dist. (at max. hght) ¹⁾			1210	1210			
Dumping distance (at 3.5 m) ¹⁾			1750	1750			

Front loader model	3X/65	3X/70 ²⁾	4X/75	4X/80	4X/85 ³⁾	5X/85	5X/90
Range 700 V							
continuous Lift capacity daN					2600	2600	2950
max. lift capacity daN					3000	3000	3460
Lifting height mm ¹⁾					4150	4460	4460
Digging depth mm ¹⁾					130	250	250
Dumping dist. (at max. hght) ¹⁾					980	1080	1080
Dumping distance (at 3.5 m) ¹⁾					1610	1910	1910

¹⁾ depends on tyres ²⁾ 3X/70 only with 28 inch front tyres
³⁾ 4X/85 only with 28 inch front tyres
 1 daN = 10 N = ca. 1 kg

Frontlader-Typ	3X/65	3X/70	4X/75	4X/80	4X/85	5X/85	5X/90
Equipment							
Lift cylinder da	■	■	■	■	■	■	■
Quick-attach frame	■	■	■	■	■	■	■
manual implement lock	■	■	■	■	■	■	■
Synchronous tipping cylinder	⊘	⊘	■	■	■	■	■
Mechanical parallel guidance	■	■	■	■	■	■	■
Front guard	■	■	■	■	■	■	■
Level indicator	■	■	■	■	■	■	■
Damping system da	⊘	⊘	□	□	□	□	□
Pipe rupture protection ¹⁾	■	■	■	■	■	■	■
Lowering throttle valve	■	■	■	■	■	■	■
Load holding valve	■	■	■	■	■	■	■
Multi-coupler front loader	■	■	■	■	■	■	■
hydraulic attachment lock	⊘	⊘	□	□	□	□	□
3rd & 4th hydraulic working circuit	□	□	□	□	□	□	□
Multi-coupler for 3rd & 4th circuit	□	□	□	□	□	□	□
Tractor equipment							
Crossgate lever	■	■	■	■	■	■	■
Front window opens completely	⊘	■	■	■	■	■	■
3rd & 4th control circuit	□	□	□	□	□	□	□
Multi-coupler attachment	□	□	□	□	□	□	□

¹⁾ not applicable if damping system is installed



The light material bucket is available in the widths 1850 mm (0.976 m³ flush volume) and 2400 mm (1.265 m³ flush volume)



The universal bucket is available in four different sizes: 1600 mm wide (0.538 m³ flush volume), 1850 mm wide (0.622 m³ flush volume), 2100 mm wide (0.706 m³ flush volume) and 2400 mm wide (0.807 m³).

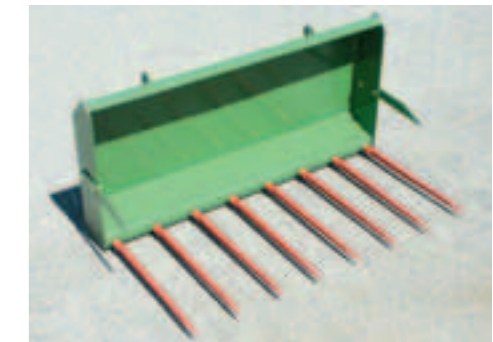

The manure fork is available in 1500 mm and 2100 mm widths.



The bale grab is designed for bales with an outer diameter ranging from 900 mm to 1900 mm.



The big bale fork has three tines and is 1500 mm wide.



The pallet fork is designed for loads up to 2000 kg, tine length 1100 mm.



The heavy-duty bucket is available in the widths 1600 mm (0.512 m³ flush volume) and 2100 mm (0.672 m³ flush volume)



The silage bucket is available in two sizes: 1800 mm wide (1.00 m³ flush volume) and 2200 mm (1.25 m³ flush volume).



The standard-equipped semi-automatic attachment lock is operated with a single lever.

FENDT

Leaders drive Fendt



www.fendt.com

AGCO GmbH – Fendt-Marketing
87616 Marktoberdorf, Germany
Fax +49 (0) 8342 / 77-220

 **AGCO**
Your Agriculture Company

Fendt is a world wide Brand of AGCO.

All data regarding delivery, appearance, performance, dimensions and weight, fuel consumption and running costs of the vehicles correspond with the latest information available at the time of going to press. Changes may be made before the time of purchase. Your Fendt dealer will be pleased to supply you with up-to-date information.

EU/1-EN/10-12/1,0-R0