







MEASUREMENTS

Follow the pattern instructions for your size

Size	S	M	L	XL	XXL	XXXL
Chest 	81/86 cm 32/34"	91/97 cm 36/38"	102/107 cm 40/42"	112/117 cm 44/46"	122/127 cm 48/50"	132/137 cm 52/54"
Width 	104 cm 41"	113 cm 44½"	122 cm 48"	131 cm 51½"	150 cm 59"	159 cm 62½"
Full Length 	60 cm 23¾"	62 cm 24½"	64 cm 25¼"	69 cm 27¼"	70 cm 27½"	71 cm 28"
Sleeve Length 	45 cm 17¾"	45 cm 17¾"	49 cm 19¼"	49 cm 19¼"	49 cm 19¼"	49 cm 19¼"
Yarn A* No Balls 	6	7	8	9	10	11
Yarn B* No Balls 	4	4	5	6	6	7
Yarn You also need	F235 Country Classic, DK, 50g, shade A 855 Rose Pink and shade B 856 Coral. 1 Pair of 4mm (UK8 – USA6) Knitting Needles and 1 Pair of 3¼mm (UK10 – USA3) Knitting Needles. Stitch Holders.					

*Average number of balls required when you use the specified Sirdar yarn and tension shown below

TENSION & NEEDLES

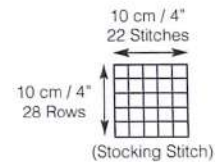
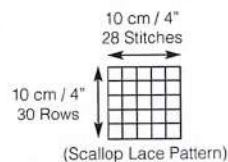



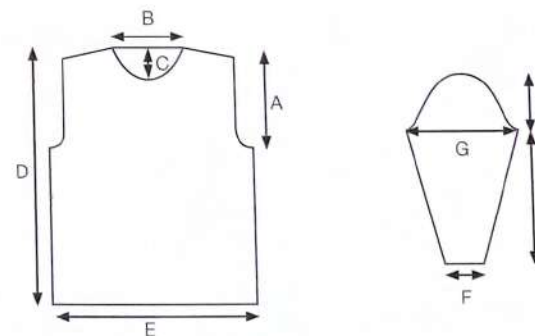

PIECE MEASUREMENTS

- A 22 [24:28:28:30:30]cm
(8¾ [9½:11:11¼:11¾])
(approximately)
- B 22 [23:23:24:24:24]cm
(8¾ [9:9:9½:9½])
- C 7 [7:8:8:8]cm
(2¾ [2¾:3:3:3])
- D 60 [62:64:69:70:71]cm
(23¾ [24½:25¼:27¼:27½:28])
(approximately - measured from back of neck)
- E 52 [56:61:66:75:80]cm
(20½ [22:24:26:29½:31½])
- F 20 [21:22:23:24:25]cm
(8 [8¼:8¼:9:9¼])
- G 36 [38:42:44:46:48]cm
(14 [15:16½:17¼:18:19])
- H 45 [45:49:49:49:49]cm
(17¾ [17¾:19¼:19¼:19¼])
(approximately)
- I 7 [8.5:8.5:9:11:11]cm
(2¾ [3¼:3¼:3½:4¼:4¼])



MEASUREMENTS

Follow the pattern instructions for your size

Size	S	M	L	XL	XXL	XXXL
Chest	 81/86 cm 32/34"	91/97 cm 36/38"	102/107 cm 40/42"	112/117 cm 44/46"	122/127 cm 48/50"	132/137 cm 52/54"
Width	 116 cm 45 3/4"	127 cm 50"	136 cm 53 1/2"	147 cm 58"	156 cm 61 1/2"	167 cm 66"
Full Length	 61 cm 24"	63 cm 24 3/4"	65 cm 25 1/2"	67 cm 26 1/2"	69 cm 27 1/4"	71 cm 28"
Sleeve Length	 45 cm 17 3/4"	45 cm 17 3/4"	46 cm 18"	47 cm 18 1/2"	47 cm 18 1/2"	47 cm 18 1/2"
Yarn* No Balls	 11	12	14	15	16	17
Yarn You also need	F235 Country Classic, DK, 50g, shade 871 True Red 1 Pair of 4mm (UK8 - USA6) Knitting Needles and 1 Pair of 3 1/4mm (UK10 - USA3) Knitting Needles. 1 4mm (UK8 - USA6) 80cm Circular Needle and 1 3 1/4mm (UK10 - USA3) 80cm Circular Needle if required. Stitch Holders.					

*Average number of balls required when you use the specified Sirdar yarn and tension shown below

TENSION & NEEDLES

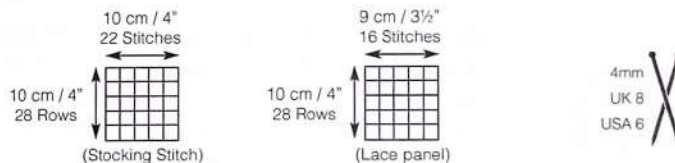

PIECE MEASUREMENTS

- A 22 [24:26:27:28:29] cm
(8 3/4 [9 1/2:10 1/4:10 3/4:11:11 1/2]")
- B 22 [22:23.5:23.5:23.5:23.5] cm
(8 3/4 [8 3/4:9 1/4:9 1/4:9 1/4]")
- C 3 [3:3:3:3] cm
(1 1/4 [1 1/4:1 1/4:1 1/4]")
- D 49 [54:58:62.5:65.5:71] cm
(19 1/4 [21 1/4:22 3/4:24 1/2:25 3/4:28]")
- E 61 [63:65:67:69:71] cm
(24 [24 3/4:25 1/2:26 1/2:27 1/4:28]")
(measured from side of back neck)
- F 54 [59.5:64.5:69.5:74.5:79.5] cm
(21 1/4 [23 1/2:25 1/2:27 1/4:29 1/4:31 1/4]")
- G 58 [63.5:68:73.5:78:83.5] cm
(22 3/4 [25:26 3/4:29:30 3/4:32 3/4]")
- H 7 [7:8:8:8] cm
(2 3/4 [2 3/4:3:3:3]")
- I 20 [21:22:23:24:25] cm
(8 [8 1/4:8 1/2:9:9 1/4]")
- J 38 [40:44:46:48:50] cm
(15 [15 3/4:17 1/4:18:19:19 1/2]")
- K 45 [45:46:47:47] cm
(17 3/4 [17 3/4:18:18 1/2:18 1/2]")
- L 6 [7:7:8:8:9] cm
(2 1/2 [2 3/4:2 3/4:3:3 1/2]")

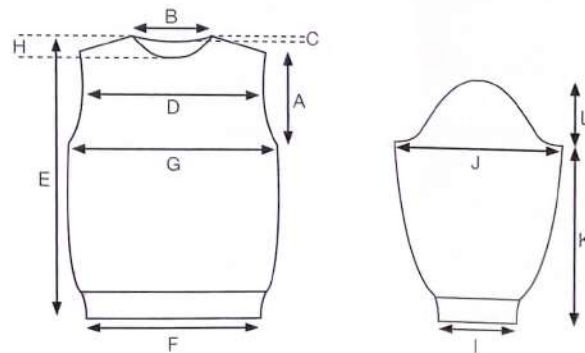





Sweater
in shade 871



MEASUREMENTS

Follow the pattern instructions for your size

Size	S	M	L	XL	XXL	XXXL
Chest	 81/86 cm 32/34"	91/97 cm 36/38"	102/107 cm 40/42"	112/117 cm 44/46"	122/127 cm 48/50"	132/137 cm 52/54"
Width	 117 cm 46"	127 cm 50"	137 cm 54"	147 cm 58"	157 cm 62"	167 cm 66"
Full Length	 58 cm 22 3/4"	60 cm 23 3/4"	62 cm 24 1/2"	64 cm 25 1/4"	66 cm 26"	68 cm 26 3/4"
Sleeve Length	 41 cm 16"	41 cm 16"	42 cm 16 1/2"	43 cm 17"	43 cm 17"	43 cm 17"
Yarn* No Balls	 11	12	13	14	16	17
Yarn You also need	F235 Country Classic, DK, 50g, shade 851 Oat Beige 1 Pair of 4mm (UK8 – USA6) Knitting Needles, 1 Pair of 3 1/4mm (UK10 – USA3) Knitting Needles and Stitch Holders.					

*Average number of balls required when you use the specified Sirdar yarn and tension shown below

TENSION & NEEDLES

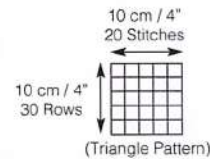





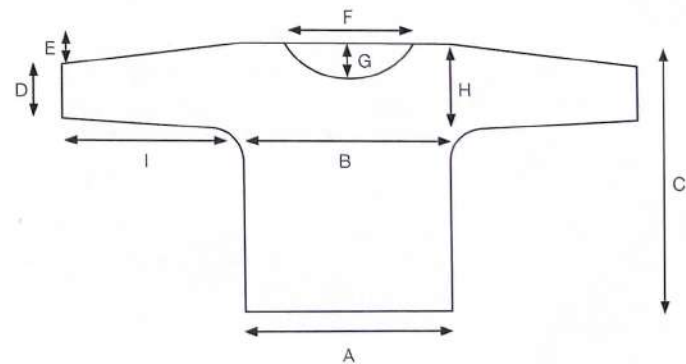

PIECE MEASUREMENTS

- A 54 [59.5;64;69.5;74;79.5] cm
(21 1/4 [23 1/2;25 1/4;27 1/2;29 3/4;31 1/2])"
- B 58.5 [63.5;68.5;73.5;78.5;83.5] cm
(23 [25;27;29;31;33])"
- C 58 [60;62;64;66;68] cm
(22 3/4 [23 3/4;24 1/2;25 1/4;26;26 3/4])"
(approximately measured from back of neck)
- D 20 [21;22;23;24;25] cm
(8 [8 1/4;8 3/4;9;9 1/2;9 3/4])"
- E [8 [8;8;8;8] cm
(3 [3;3;3;3])"
- F 21 [22;22;23;23;23] cm
(8 1/4 [8 3/4;8 3/4;9;9;9])"
- G 7 [7;8;8;8;8] cm
(2 3/4 [2 3/4;3;3;3;3])"
- H 31 [33;35;36;37;38] cm
(12 [13;13 3/4;14;14 1/2;15])"
- I 41 [41;42;43;43;43] cm
(16 [16;16 1/2;17;17;17])"



MEASUREMENTS

Follow the pattern instructions for your size

Size	S	M	L	XL	XXL	XXXL
Chest 	81/86 cm 32/34"	91/97 cm 36/38"	102/107 cm 40/42"	112/117 cm 44/46"	122/127 cm 48/50"	132/137 cm 52/54"
Width 	100 cm 39½"	111 cm 43¼"	121 cm 47¼"	131 cm 51½"	141 cm 55½"	151 cm 59½"
Full Length 	53 cm 21"	55 cm 21¼"	57 cm 22½"	59 cm 23¼"	61 cm 24"	63 cm 24¾"
Sleeve Length 	50 cm 19¾"	50 cm 19¾"	51 cm 20"	52 cm 20½"	52 cm 20½"	52 cm 20½"
Yarn* No Balls 	9	10	11	13	14	15
Buttons 	6	6	6	6	6	6
Yarn Button Ref You also need	F235 Country Classic, DK, 50g, shade 865 Teal Sirdar Elegant Button Code B561 I-0785 1 pair of 4mm (UK8 - USA6) Knitting Needles, 1 pair of 3¼mm (UK10 - USA3) Knitting Needles and Stitch Holders					

*Average number of balls required when you use the specified Sirdar yarn and tension shown below

TENSION & NEEDLES

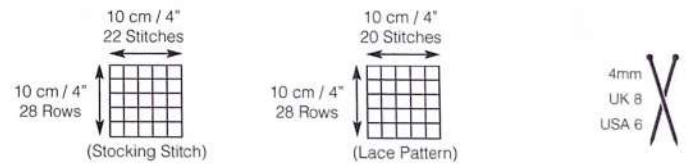

PIECE MEASUREMENTS

- A 50 [55.5:60.5:65.5:70.5:75.5]cm
(19¾ [22:24:25¾:27¾:29¾]")
- B 44 [49.5:54:59.5:64:69.5]cm
(17¼ [19½:21¼:23½:25¼:27½]")
- C 53 [55:57:59:61:63]cm
(21 [21¾:22½:23¼:24:24¾]")
(includes half of sleeve top)
- D 23 [24:24:25:25:25]cm
(9 [9½:9½:9¾:9¾:9¾]")
- E 21 [23:25:26:27:28]cm
(8¼ [9:9¾:10¼:10¾:11]")
- F 10 [11:11:11:11:11]cm
(4 [4¼:4¼:4¼:4¼:4¼]")
- G 20 [21:22:23:24:25]cm
(8 [8¼:8¾:9:9¾:9¾]")
- H 50 [50:51:52:52:52]cm
(19¾ [19¾:20:20½:20½:20½]")
- I 34 [36:40:42:44:46]cm
(13½ [14:15¾:16½:17¼:18]")
- J 8 [9:9:10:10:10]cm
(3 [3½:3½:4:4:4]")

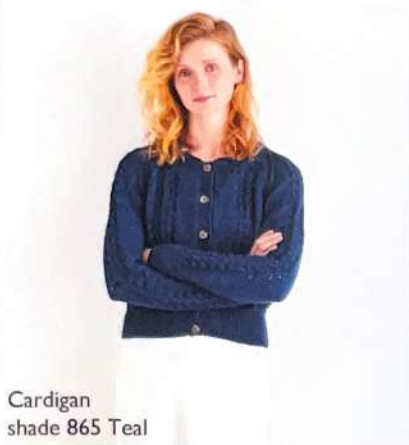
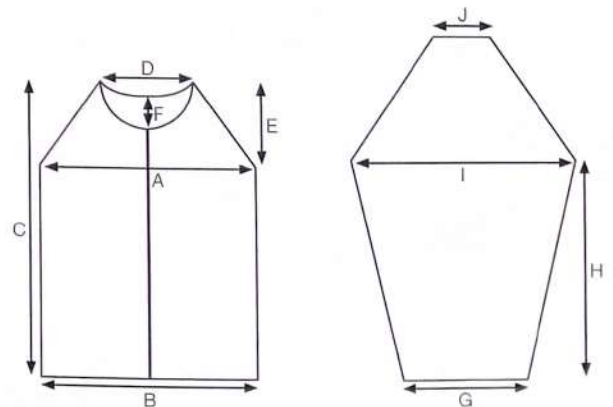







Cardigan shade 865 Teal



MEASUREMENTS

Follow the pattern instructions for your size

Size		S	M	L	XL	XXL	XXXL
Chest		81/86 cm 32/34"	91/97 cm 36/38"	102/107 cm 40/42"	112/117 cm 44/46"	122/127 cm 48/50"	132/137 cm 52/54"
Width		112 cm 44"	123 cm 48½"	133 cm 52½"	143 cm 56¼"	153 cm 60¼"	163 cm 64¼"
Full Length		61 cm 24"	63 cm 24¾"	65 cm 25½"	67 cm 26½"	69 cm 27¼"	71 cm 28"
Sleeve Length		42 cm 16½"	42 cm 16½"	43 cm 17"	44 cm 17¼"	44 cm 17¼"	44 cm 17¼"
Yarn A* No Balls		8	9	10	11	12	13
Yarn B* No Balls		4	4	5	5	6	6
Yarn You also need	F235 Country Classic, DK, 50g, A shade 850 White, B shade 852 Navy 1 Pair of 4mm (UK8 - USA6) Knitting Needles and 1 Pair of 3¼mm (UK10 - USA3) Knitting Needles. 1 4mm (UK8 - USA6) 80cm Circular Needle and 1 3¼mm (UK10 - USA3) 80cm Circular Needle if required. Stitch Holders.						

*Average number of balls required when you use the specified Sirdar yarn and tension shown below

TENSION & NEEDLES

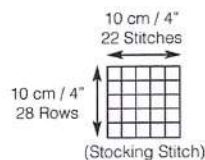

PIECE MEASUREMENTS

- A 19 [21;23;24;25;26] cm
(7½ [8¼;9;9½;9¾;10¼]"")
- B 20 [21;21;22;22;22] cm
(8 [8¼;8¼;8¾;8¾;8¾]"")
- C 61 [63;65;67;69;71] cm
(24 [24¾;25½;26½;27¼;28]"")
- D 56 [61.5;66.5;71.5;76.5;81.5] cm
(22 [24¼;26¼;28¼;30¼;32¼]"")
- E 27 [27;28;28;28;28] cm
(10¾ [10¾;11;11;11;11]"")
- F 1.5 [1.5;1.5;1.5;1.5;1.5] cm
(½ [½;½;½;½;½]"")
- G 23 [24;25;26;27;27] cm
(9 [9½;9¾;10¼;10¾;10¾]"")
- H 36 [38;42;44;46;48] cm
(14 [15;16½;17¼;18;19]"")
- I 42 [42;43;44;44;44] cm
(16½ [16½;17;17¼;17¼;17¼]"")
- J 4 [4;4;4;4;4] cm
(1½ [1½;1½;1½;1½]"")

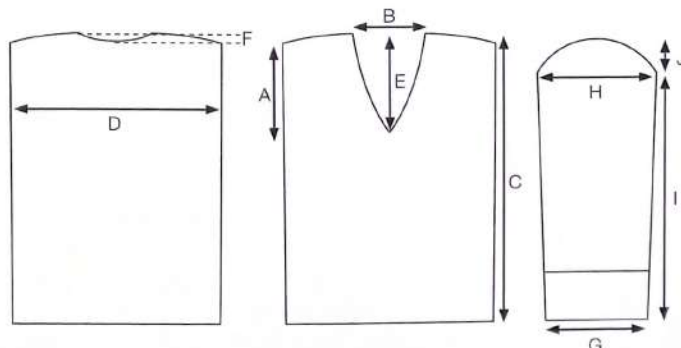

Sweater shades 850 & 852