

TESmert TESmart

User Manual

2x1 HDMI KVM Switch
4x1 HDMI KVM Switch

4K HDR USB

HK50201A2U & HK50401A2U

To Enjoy Smart

HK50201A2U & HK50401A2U

English | Deutsch | Français

Language

TESmert TESmart

EN	2X1/4X1 HDMI KVM Switch User Manual.....	01
DE	2X1/4X1 HDMI-KVM-Switch Benutzerhandbuch.....	33
FR	2X1/4X1 Switch HDMI KVM Manuel de l'Utilisateur.....	68

TESmert **TE**Smart



English



Preface

It's our great honor that you have chosen the HDMI KVM switch produced by our company, Tesla Elec Technology Co.,Ltd. In this user manual, you will learn how to operate and use this product. Please read this user manual comprehensively before use. If you have any questions, comments or suggestions, you can contact us via the following email:

support@tesmart.com.

Copyright Notice

The user manual, compiled by Tesla Elec Technology, shall not be duplicated or translated by any person or organizations without written permission. This user guide shall not be used for commodity transaction in any form or by any means (electronically, mechanically, photocopying or recording, etc.) or be used for any business practices or profitable activities. The ownership of the trade names and brand names adopted in this user manual belongs to their companies.

Address of German Distributor

TESmert GmbH

Reinbeker Weg 72.

21029 Hamburg

Germany

HRB-Nr: HRB 162780 HL

Address of Manufacture

Tesla Elec Technology Co.,Ltd

2F, Building C, Xingzhisheng Industrial Park,

No.12, Xiawei Industrial Zone, Zhangkengjing

Road, Guanlan Street,

Longhua District, Shenzhen City,









Guangdong Province, China

Contents

1. Safety Tips and Warnings	01	9.3 Connection Preparation	
2. Battery Description	02	9.4 Connection Steps	
3. Warranty Information	03	9.5 KVM Workbench(2x1 HDMI KVM Switch)	
4. Preface	04	9.6 KVM Workbench(4x1 HDMI KVM Switch)	
5. Features	05	10. Switching Method	20
6. Packing List	06	10.1 Front Panel Button	
7. Panel Description(2x1 HDMI KVM Switch)	07	10.2 IR Remote Control	
7.1 Front Panel Description		10.3 Keyboard Hot Keys	
7.2 Rear Panel Description		10.4 Mouse Gesture Mode	
8. Panel Description(4x1 HDMI KVM Switch)	09	11. Change Hot Key Combinations	28
8.1 Front Panel Description		12. Pass through mode	29
8.2 Rear Panel Description		12.1 Introduction of Pass through mode	
9. Connection Description	12	12.2 Supported keyboard and mouse categories	
9.1 Connection Diagram(2x1 HDMI KVM Switch)		12.3 Keyboard and mouse compatible model list	
9.2 Connection Diagram(4x1 HDMI KVM Switch)			

1. Safety Tips and Warnings

Tips: Read the safety tips and warnings for HDMI KVM Switch comprehensively before use. Use this produce in accordance with its instructions, safety tips and warnings to prevent unnecessary damage to the product and potential dangers to users.

-  Keep the product away from water.
-  Clean the product with dry cloth.
-  Use the product in accordance with its instructions and do not block its vents.
-  Keep the product away from ignition sources, such as heat sinks, heat accumulators, stovepipes and other heat production settings (including audio amplifiers).
-  Do not touch the product and the power cord with wet hands so as to lower the risk of electric shock and the damage to the product. Do not let the product get wet or become damp.
-  Unplug the power supply of this product in thunderstorm days or when it has been not used for a long time.
-  Do not expose this product and its battery to open fire or overheating environment. Dispose the waste battery in accordance with instructions.
-  Users shall not remove and repair the product without authorization.

2. Battery Description

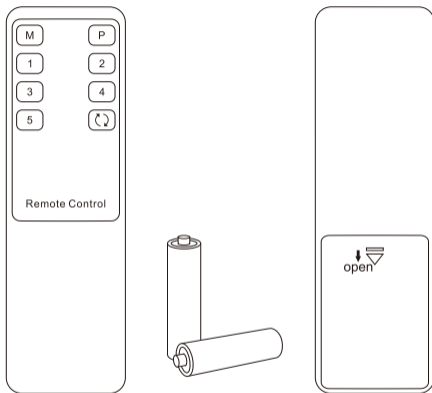

Tips: By default, the remote control is not equipped with batteries, due to the safety requirements of some express companies. Install AAA dry cells before use.

Caution: Improper disposal of the lithium battery may cause an explosion. Do not throw the battery into fire. Keep the battery away from children. Dispose the waste battery in accordance with local regulations.



3. Warranty Information

We warrant that this product will be free of defects in material and workmanship for a period of one (1) year from the date of shipment. If within the period of warranty this product proves defective under normal use, we will repair or replace this product, provided that the product has not been subjected to mechanical and electrical damage, or other abuse or modifications. If it fails under conditions other than those covered, its repair will be charged in accordance with the current price of parts and labor in effect at the time of repair. Such repairs are warranted for six (6) months from the day of reshipment to the buyer.

4. Preface

Dear Users:

HDMI KVM Switch can greatly facilitate your management of audio-video equipment and video devices. 2x1/4x1 HDMI KVM Switch can easily integrate cross-platform computer devices. Thus, you can easily control 2~4 computer devices with only 1 HDMI display.

This switch supports the use of USB hubs and USB keyboard and mouse. You can connect printer, USB drive, bar code scanner or other USB 2.0 devices to this KVM. This product also supports several other switching modes. You can switch input ports with front panel buttons, IR signals, keyboard hot keys and mouse gestures (fast switching mode). At the same time, with EDID emulators in each input port, it can keep PCs always having correct display information.

Tips: If you need to control more computers or conduct more complex and professional switching, you can also choose other products of our company. For more details, you can visit our official website: www.tesmart.com.

5. Features

- Control 2~4 computer devices with only 1 set of keyboard, mouse and monitor.
- Support resolution up to 3840*2160@60Hz 4:4:4 .
- HDCP 2.2 compliant.
- Support HDR 10 and Dolby Vision.
- Support Unix/Windows/Debian/Ubuntu/Fedora/Mac OS X /Raspbian/ Ubuntu for Raspberry Pi based system.
- Support L/R audio output.
- With USB 2.0 hub port, it is possible to connect bar code scanner, USB drive or other USB devices to KVM.
- With EDID emulators in each input port, the accuracy of the display information of PCs will be secured.
- Support IR signals, front panel buttons, keyboard hot keys and mouse gesture to control KVM to switch input ports.
- Support hot-plug and the devices connected to the KVM can be added or removed at any time without turning off the computers.
- Support auto switching to monitor computers in a specified time interval.
- Available to use keyboard and mouse without any delay after switching input ports.
- Support keyboard and mouse pass through mode to improve mouse and keyboard compatibility.

6. Packing List

- 1 * HDMI KVM Switch
- 1 * DC 5V Power Adapter
- 1 * IR Remote Control
- 1 * User Manual
- 2 * KVM cables (HDMI + USB) (1.5 meters) (Choosable)

Tips: After received the product, you should check the packing list carefully to make sure that no components have been lost and no damage to the product has been caused during transportation. If you have any problems, you can contact with us.

7. Panel Description

7.1 Front Panel Description



ID	Name	Function
1	Power switch	Turn on or turn off power supply.
2	L/R Out	Connect to audio or L/R audio output devices.
3	USB connection status indicator	LEDs will be lit (blue) if the KVM's USB data ports are connected to the computers' USB ports.

ID	Name	Function
4	Input selection status indicator	The LEDs will be lit (blue) to indicate the current selected computer device.
5	Input selection button	Select input sources.
6	IR receiver	Receive IR remote signal.
7	Keyboard and mouse pass through mode status	LED will be lit (green) if keyboard and mouse pass through mode is activated.

7.2 Rear Panel Description

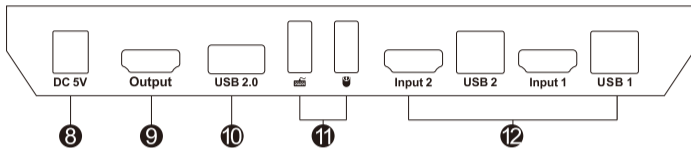

ID	Name	Function
8	DC5V	5V DC power supply
9	HDMI output	Connect to HDMI display for video output.
10	Standard USB 2.0 port	Connect to USB 2.0 device, such as printer, bar code scanner, USB drive and touchscreen, etc.
11	Keyboard and mouse input	For USB keyboard and mouse input, including wireless keyboard and mouse.

ID	Name	Function
11	Keyboard and mouse input	For USB keyboard and mouse input, including wireless keyboard and mouse.
12	KVM input ports group	2 input devices can be connected to the KVM at the same time. Each group contains a HDMI port (left) and a USB port (right). Connect the ports to corresponding input devices for signal input.

8. Panel Description

8.1 Front Panel Description

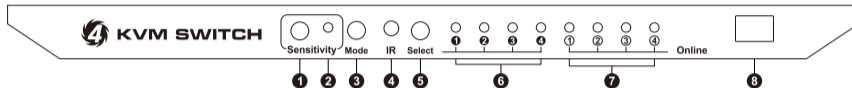

ID	Name	Function
1	Sensitivity adjust button (Mouse gesture mode)	Adjust the sensitivity of the mouse under fast switching mode. Total: 5 sensitivity levels. Factory setting: level 2. Adjusting: cyclically (low-high). Press this button once to adjust the sensitivity to the next level.
2	Sensitivity adjust indicator (Mouse gesture mode)	The LED will be lit (blue) if the sensitivity of the mouse is adjusted (under fast switching mode). The flicker times will correspond to current sensitivity level (once for level 1, twice for level 2, and so on).

8.1 Front Panel Description

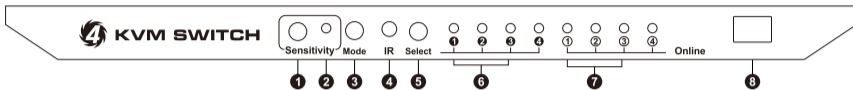

ID	Name	Function
3	Keyboard and mouse pass through mode status	LED will be lit (blue) if keyboard and mouse pass through mode is activated.
4	IR receiver	Receive IR remote signal.
5	Input selection button	Select input sources.
6	Input selection status indicator	The LEDs will be lit (blue) to indicate the current selected computer device.
7	USB connection status indicator	LEDs will be lit (blue) if the KVM's USB data ports are connected to the computers' USB ports.
8	Power switch	Turn on or turn off power supply.

8.2 Rear Panel Description

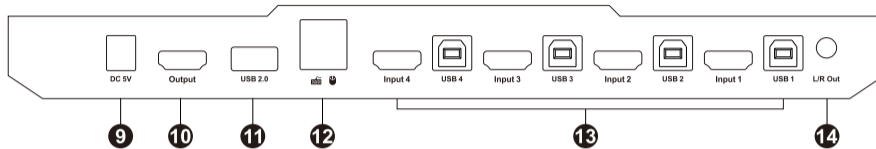

ID	Name	Function
9	DC 5 V	5 V DC power supply
10	HDMI output	Connect to HDMI display for video output.
11	Standard USB 2.0 port	Select input sources.
12	Keyboard and mouse input	For USB keyboard and mouse input, including wireless keyboard and mouse.
13	KVM input ports group	2 input devices can be connected to the KVM at the same time. Each group contains a HDMI port (left) and a USB port (right). Connect the ports to corresponding input devices for signal input.
14	L/R out	Connect to audio or L/R output devices.

9. Connection Description

9.1 Connection Diagram (2x1 HDMI KVM Switch)

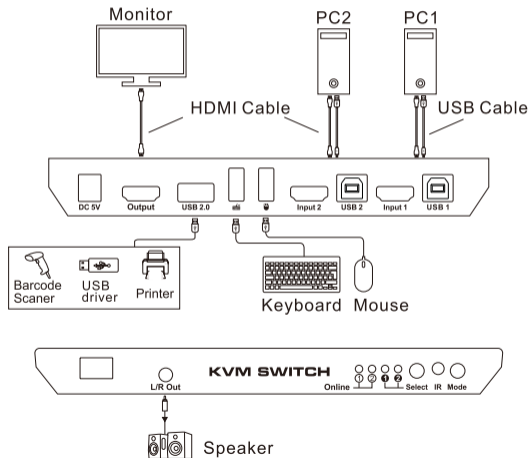

9.2 Connection Diagram (4x1 HDMI KVM Switch)

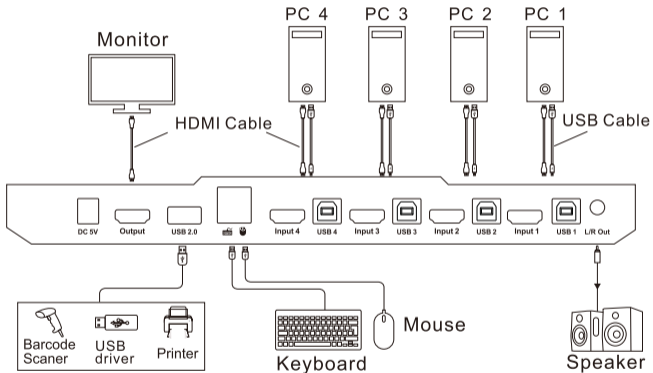

Tips: The PC 1 and PC 2 here refer to common HDMI input devices. That's to say, TV Box, Amazon Fire TV Stick, Sky Q Box and other gaming devices can also be connected to this KVM.

9.3 Connection Preparation

- Take into consideration all devices required to be connected and prepare a workbench large enough before the connection.
- Lay out the cables properly to facilitate the control of power supply as a lot of power sockets and plug boards will be adopted in connection.
- Use different colors marked cables as a lot of cables will be adopted in connections.

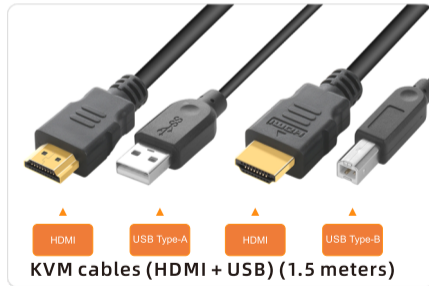

9.4 Connection Steps

1. Connect PC 1 with one HDMI cable and one USB type A to type B cable.
2. Connect one end of the HDMI cable to KVM's input port 1 and the other end to PC 1. Connect the type-B end of the USB cable to KVM's USB data port, and the type-A end to PC 1 (as shown below).



3. Connect PC 2 in the same way as shown above (2x1 HDMI KVM) ;
Connect PC 2 ~ PC 4 in the same way as shown above (4x1 HDMI KVM).

4. Connect external mouse and keyboard to KVM's keyboard and mouse input port.
5. Connect an USB 2.0 device to KVM's corresponding USB data port.



Tips: For the normal service of hotkeys, we recommend you use the full-key external keyboard with a separate [Scroll Lock] key (as shown below).

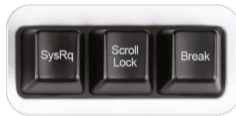

6. Connect KVM's HDMI output port to a display with one HDMI cable.



7. Connect KVM's L/R out port to external audio device with one audio cable.

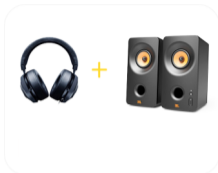

8. Connect the power cable to KVM's DC 5V port and plug it to a power socket with stable DC.



9. By now, the connection has been completed. Turn on the power supply and the KVM will begin to work.

9.5 KVM Workbench(2x1 HDMI KVM Switch)

A workbench with 2x1 HDMI KVM successfully connected is shown as below:



9.6 KVM Workbench(4x1 HDMI KVM Switch)

A workbench with 4x1 HDMI KVM successfully connected is shown as below:



10. Switching Method

10.1 Front Panel Button

Your HDMI KVM Switch is now activated and you can switch to any input devices at any time with front panel keypad, IR remote control, keyboard hot keys and mouse gesture mode. You can choose your favorite switching mode according to your personal needs and habits.

- Switch the input devices by pressing the button [Select] on the front panel of the HDMI KVM Switch.



Tips: The LEDs ❶, ❷, ❶ on the front panel will be lit, if you switch to input device 1. It indicates that the USB ports of input device 1 and input device 2 have been successfully connected. The HDMI signal of input device 1 is now output by the display.

→ Press the button [Select] again to switch to input device 2.



Tips: The LEDs ①, ②, ② on the front panel will be lit, if you switch to input device 2. It indicates that the USB ports of input device 1 and input device 2 have been successfully connected. The HDMI signal of input device 2 is now output by the display.

Control 4x1 HDMI KVM Switch in the same way as shown above.

- Switch input devices by pressing the button [Select] on the front panel of HDMI KVM Switch.



Tips: The LEDs ① ② ③ ④ ① on the front panel will be lit, if you switch to input device 1. It indicates that the USB ports of input devices 1, 2, 3, 4 have been successfully connected. The HDMI signal of input device 1 is now output by the display.

- Press the button [Select] again to switch to input device 2.



Tips: The LEDs ① ② ③ ④ ② on the front panel will be lit, if you switch to input device 2. It indicates that the USB ports of input devices 1, 2, 3, 4 have been successfully connected. The HDMI signal of input device 2 is now output by the display.

10.2 IR Remote Control

- Use IR remote to switch the input devices.

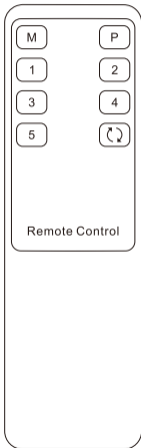

[1]-Switch to input port 1

[2]-Switch to input port 2

[3]-Switch to input port 3

[4]-Switch to input port 4

Tips: Button [3] and button [4] are only for 4x1 HDMI KVM Switch.
Unspecified buttons at above are non-functional.

10.3 Keyboard Hot Keys

- Use external keyboard hot keys to switch the input devices.

Tips: The keyboard hot keys can only normally work with the external keyboard correctly connected to the keyboard and mouse input port of the KVM. For the normal service of hot keys, we recommend you use external keyboard with a separate [Scroll Lock] key.

First, press [Scroll Lock] key twice within 2 seconds and you can begin to switch the input devices after the buzzer beep once. Second, enter following hot key commands within 3 seconds and the KVM will execute the corresponding commands.

Select previous input port:

[Scroll Lock] → [Scroll Lock] → [PgUp]



Select next input port:

[Scroll Lock] → [Scroll Lock] → [PgDn]



Select port by port number:

[Scroll Lock] → [Scroll Lock] → [1]~[4]



Tips: Select port by port number in accordance with the operation order presented above;

Enable or disable buzzer sound:
[Scroll Lock]→[Scroll Lock]→[F11]



Tips: Disable buzzer sound as shown above; Repeat this step to enable the buzzer sound; Your operation on the KVM will make buzzer no sound.

Increase or decrease auto switching time interval:
[Scroll Lock]→[Scroll Lock]→[+] / [-]



Tips: This hot key command can only work while the auto switching mode is activated. Press [Scroll Lock] key twice and keep pressing [+] / [-] key to continuously adjust the time interval. Increase or decrease 1 second at one time. The maximum time interval is 250 seconds.

Turn on auto switching mode:
[Scroll Lock]→[Scroll Lock]→[Space]



Tips: Enter auto switching mode by following the operation order shown above. The default auto switching time interval is 6 seconds. You can change the time interval by following the step presented below. Press [Esc] key to exit the auto switching mode.

Turn on or turn off pass through mode:
[Scroll Lock] → [Scroll Lock] → [F2]



Tips: Pass through mode is on by default. Turn on or turn off pass through mode by following the operation order above. Read chapter 12 for more information about pass through mode.

Turn on or turn off fast switching mode:
[Scroll Lock] → [Scroll Lock] → [F12]



Tips: Turn on fast switching mode by following the operation order above. Repeat this step to turn off the fast switching mode. Read next chapter for more information about fast switching mode.

10.4 Mouse Gesture Mode

The fast switching mode is not activated under standard settings. You need to follow the hot key command in page 26 to turn on the fast switching mode.

- Use your mouse to touch the left edge of your monitor twice within 1 second and the KVM will switch to the previous input port.
- Use your mouse to touch the right edge of your monitor twice within 1 second and the KVM will switch to the next input port.



11. Change Hot Key Combinations

There are two kinds of trigger hot keys in this product, the default is [Scroll Lock] key, and the alternative is the [Right-Ctrl] key. If [Scroll Lock] Key has been used for other functions, you can switch the hot key to [Right-Ctrl] by :

Method 1:

- Press and keep holding the [Select] button on the front panel until you hear the buzzer is beeping, then restart KVM.

Method 2:

- Press [Scroll Lock] → [Scroll Lock] → [F1], and you will switch the control hot key to [Right-Ctrl].

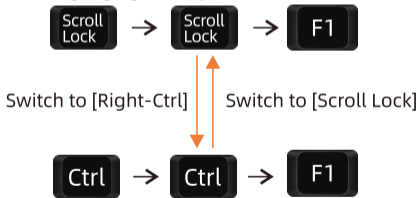

- Vice verse, Press [Right-Ctrl] → [Right-Ctrl] → [F1], and you will switch the control hot key to [Scroll Lock].

12. Pass through mode

12.1 Introduction of Pass through mode

Pass through mode is a new function, which is can better improve keyboard and mouse compatibility and enhance user experience. After using keyboard hotkeys Scroll Lock → Scroll Lock → F2 to turn on the Pass through mode, the keyboard and mouse are equivalent to directly connecting to the computer. At this time, you can use more keyboard and mouse functions and special functions that are not supported by ordinary KVM.

12.2 Supported keyboard and mouse categories

→ a. Multimedia keyboard

Multimedia keyboard means that adds multimedia keys, based on normal keyboard. Multimedia buttons generally refer to play, pause, last song, next song, fast forward, fast backward, open email, open browser and so on.

→ b. The game keyboard and mouse

Game keyboard and mouse generally refer to mechanical keyboard, keyboard with custom macro keys, mouse with custom function keys.

Tips: There are two ways to set a custom key:

1. Use the software provided by the original keyboard and mouse factory and controlled by the computer side to edit the function keys;
2. Use the keyboard to enter the key editing mode to edit the function keys.(The current version of KVM does not support the control software of the original keyboard and mouse, so the function keys can only be edited by the second way.)

→ c. Wireless keyboard and mouse

Support the use of 2.4 GHz USB dongle wireless keyboard and mouse

12.3 Keyboard and mouse compatible model list

Tips: The following list is from the most representative models of keyboard and mouse that have been tested in the laboratory, mainly from manufacturers with a high market share.

Brand	Model	Brand	Model	Brand	Model	Brand	Model
Agio	WQ-641	Logitech	G510	Logitech	Marble Mouse	RAPOO	X220
Dell	KB212-B	Logitech	G710	Logitech	Mk540	RAZER	RZ01-0145
Dell	KB522	Logitech	G910	Logitech	Mx1100	RAZER	RC30-021203
Logitech	G105	Logitech	K400PLUS	Logitech	Mx518	Corsair	K55
Logitech	G500S	Logitech	K845	Microsoft	Wireless Desktop 2000	Corsair	K70LUX

