

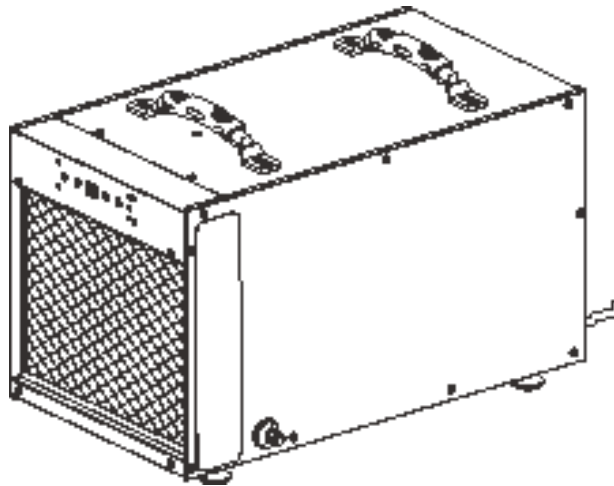

WatchDog NXT60

Installation and Operations Manual



Seaira Global, LLC
14021 NC Highway 50
Surf City, NC 28445
(910) 660-0962

Table of Contents

Important Notes	2
Warranty Registration	2
Specifications	3
How it Works	3
Installation Requirements	3
Installation	4
Key Functions	4
Indicator Lights	6
Remote Control	7
Operating Instructions	8
Unit Diagram	9
Maintenance	9
Dehumidifier Storage	11
Ducted Applications	11
Troubleshooting	12
Spare Parts	13
Warranty Information	14

Important Notes

- Always connect your dehumidifier using a grounded, dedicated electrical connection that is GFCI protected with at least 15 amp capacity.
 - The use of any other type of wiring will void your warranty.
- Install dehumidifier according to all applicable local, state, and national codes
- Be sure to follow your GFCI manufacturer's maintenance instructions. You will typically need to test the operation of the trip circuit monthly.
 - For ease of testing and operation, it may be helpful to put the test switch and indicator lights in a convenient location.
- Your dehumidifier should only be repaired by a qualified technician.
- Do not insert objects or your fingers into the inlet or discharge.
- Do not use water to clean the exterior of the dehumidifier. To clean unit, unplug from power, then use a damp cloth to wipe the exterior.
- Do not stand on dehumidifier or place objects on it.
- Do not use with extension cord or plug adapter.
- Unless otherwise noted, all maintenance should be done with the unit powered off.

Warranty Registration

Your dehumidifier comes with an extensive warranty. To register your unit simply fill out and return the warranty form provided in your dehumidifier box.

For future reference, write down the model, serial number, and date of purchase for your dehumidifier. This information is necessary for seeking assistance in the future and can be found on the data label on the side of the unit.

Model Number:

Date Of Purchase:

Serial Number:

For additional questions concerning your dehumidifier, contact your local installer or call Seaira Global at (910) 660-0962.

Specifications

Capacity @ 80°F/60%RH: 60 Pints Per Day

Airflow @ 0.0" SP: 155CFM

Operating Temp. Range: 33-105°F

Operating Relative Humidity Range: 36%-90%

COP: 2.45 L/kWh

Refrigerant: R410A

Amperage Usage: 4.05 Amps

Power Supply: 115V/60Hz/Single Phase

Outlet Requirement: 15 Amp, 3 Prong, GFCI

Sound Level: 59 dBa

Dimensions LxWxH: 21.7" x 12" x 12"

ETL Listed: Yes

How It Works

WatchDog dehumidifiers use an integrated humidistat to monitor the conditioned space. When the relative humidity goes above the selected setpoint, the dehumidifier will energize. Air is then drawn across an evaporator coil, which is cooler than the dew point of air. This means moisture will condense out of the air. The air is then reheated through the condenser coil and distributed back into the room.

Installation Requirements

- The area where the dehumidifier is located should be sealed with a vapor barrier.
- If the unit is installed in a crawl space, all vents should be sealed.
- For proper ventilation, neither the inlet or discharge should be positioned against a wall. The inlet needs a minimum of 12" clearance and the discharge requires a minimum of 36" clearance.
- For the best air diffusion, install the unit so that a side panel faces the wall.
- WatchDog dehumidifiers are only intended for operation when the unit is upright and level with the feet on the ground.

Installation

1. Place dehumidifier on a level surface.

- Do not place unit directly on vapor barrier. For example, use blocks or pavers to create a level surface.
- If unit has been turned or flipped so that the compressor did not remain upright, place the unit on a level surface and wait a minimum of 2 hours before proceeding.

2. Set up the drain line

- The drain line should be routed to a suitable drain on the outside.
- THE DRAIN MUST FLOW DOWN WITH NO LOOPS OR DIPS.
- **Recommended Drain Option- Transition to PVC Pipe**

1. Cut a piece of 3/4"OD PVC that is approx. 6" long.
2. Insert cut PVC into a 3/4" elbow.
3. Attach PVC+elbow to a 3/4"OD length of PVC to drain. Keep the length of PVC as short as possible.
4. Insert the open end of dehumidifier drain tube into 6" piece of PVC so that it does not extend into elbow fitting.
5. For a proper flow, a minimum downward slop of 1" per 10' run is required.
6. Support the PVC tubing so that it maintains a smooth downward flow to drain.



3. Plug unit into a dedicated 15 amp GFCI outlet.

Key Functions

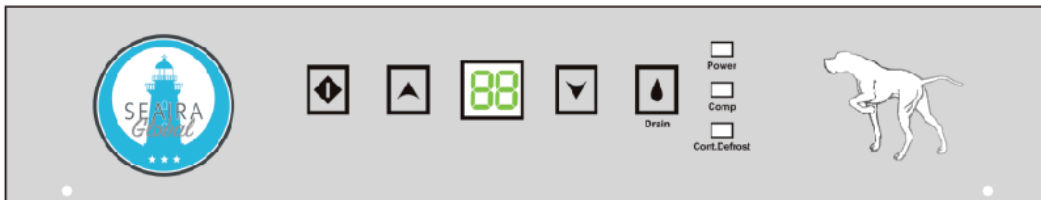

1. Power Key

- Use this button to turn the dehumidifier on and off.
- Press once to turn machine on. You will hear two beeps and the  light will illuminate green (solid or flashing depending on mode).
- Press the power button a second time and you will hear one beep as the machine shuts down. Note that there is a 1 minute fan delay.

2. Arrow Buttons

- Use the up and down arrows to set the desired humidity setpoint on the display screen. 
- The setpoint can be any number between 36%-90%. When the indoor humidity is higher than the setpoint, the unit will operate.
- * Keep in mind that the displayed humidity levels are approximate (+/-5%)

3. Continuous Mode

- To set the unit to run continuously regardless of humidity, simply use the down arrow key to set the humidity below 36%.
- The continuous light will illuminate green and the display will show “CO”.
- To switch back to normal humidistat operation, use the arrow keys to move the setpoint above 36%.

4. Auxillary Terminals A5/A6

- The A5/A6 on the terminal strip can be used as a safety switch for an external float switch.
- It should be set to N/O (normally open) at the accesory float switch.
- If an E4 error occurs immediately , switch the wiring to N/C (normally closed) on the external switch. Note that you may need to unplug the unit to reset the error code.

Indicator Lights

1. Humidity Display Screen

- The display screen has two functions:
 1. When the unit is powered on, it shows the humidity of the space
 2. When setting the desired humidity level, the screen will show the set point. After a brief delay, it will revert to current humidity of the space.

2. Power Indicator Light

- This light indicates that the unit is properly powered on and ready to operate.
- Always make sure the unit is “off” prior to performing any service, unless otherwise indicated.
- If the humidity is above the setpoint, the light will be solid green and the machine will operate.
- If the humidity is below the setpoint, the unit will be in standby mode and the light will be flashing.

3. Continuous Mode/ Auto Defrost Light

- When the light illuminates green, it indicates that the dehumidifier is set to continuous operation mode.
- When the light illuminates red, it means the unit is in auto defrost mode and clearing the evaporate coils of any ice buildup.

4. Compressor Light

- When the light illuminates red, it indicates the compressor has been initiated but is currently warming up.
- Once the light switches to green, it means the compressor is currently in working status.

Remote Control Instructions

WatchDog Dehumidifiers can be controlled using an optional remote accessory. The remote connects to your dehumidifier via a 25' CAT 5 cable, with the integrated sensor giving you multiple options monitoring surrounding conditions.

Example #1- Install the dehumidifier in the laundry room and duct it into the living room. Mount the remote in the living room and use the remote sensor.

Example #2- Install the dehumidifier in your crawl space with the remote mounted in your garage.

NOTE: The symbols indicated below only show when the remote is powered on.

1. On/Off (Power) Button

Press the on/off button and the machine will start running. Press the button again to turn the machine off.

2. Up Button/ Down Button

Use the up and down arrows to adjust the humidity level.

3. Mode

Use the mode button to switch between dehumidifier and a ducted application.

- The ☉ symbol on the display indicates the sensor on the remote control is being utilized.
- The 💧 symbol on the display indicates the sensor on the dehumidifier is being utilized.

4. Temperature

The T button changes the temperature reading on your remote. The remote comes from the factory in Celsius. Press this button once to switch to Fahrenheit.

5. Continuous

Press this button to switch the unit into continuous mode. "CONT." will appear on the display screen.

6. Drain Pump

This button is not applicable for WatchDog NXT60 models.

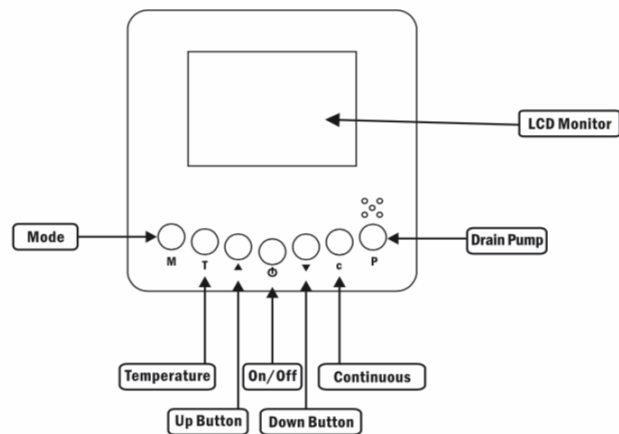

Operating Instructions

1. Start the machine

- Press the power key to turn the dehumidifier on.

2. Adjust the settings

- Use the up and down arrow keys to adjust your desired setpoint (typically 50-55%)

3. Stop the machine

- Press the power button again and the dehumidifier will stop. Note that the fan will continue to operate for 1 minute after the unit has shut off. DO NOT DISCONNECT THE POWER CORD TO FORCE THE UNIT TO STOP.

4. Water Drainage

- During normal operation, the dehumidifier will automatically drain due to gravity.
- If you want to move or store the machine, wait at least 10 minutes to allow the unit to completely defrost.
- Once defrosted, lean the dehumidifier gently towards the drain to ensure it is completely dry.

Unit Diagram

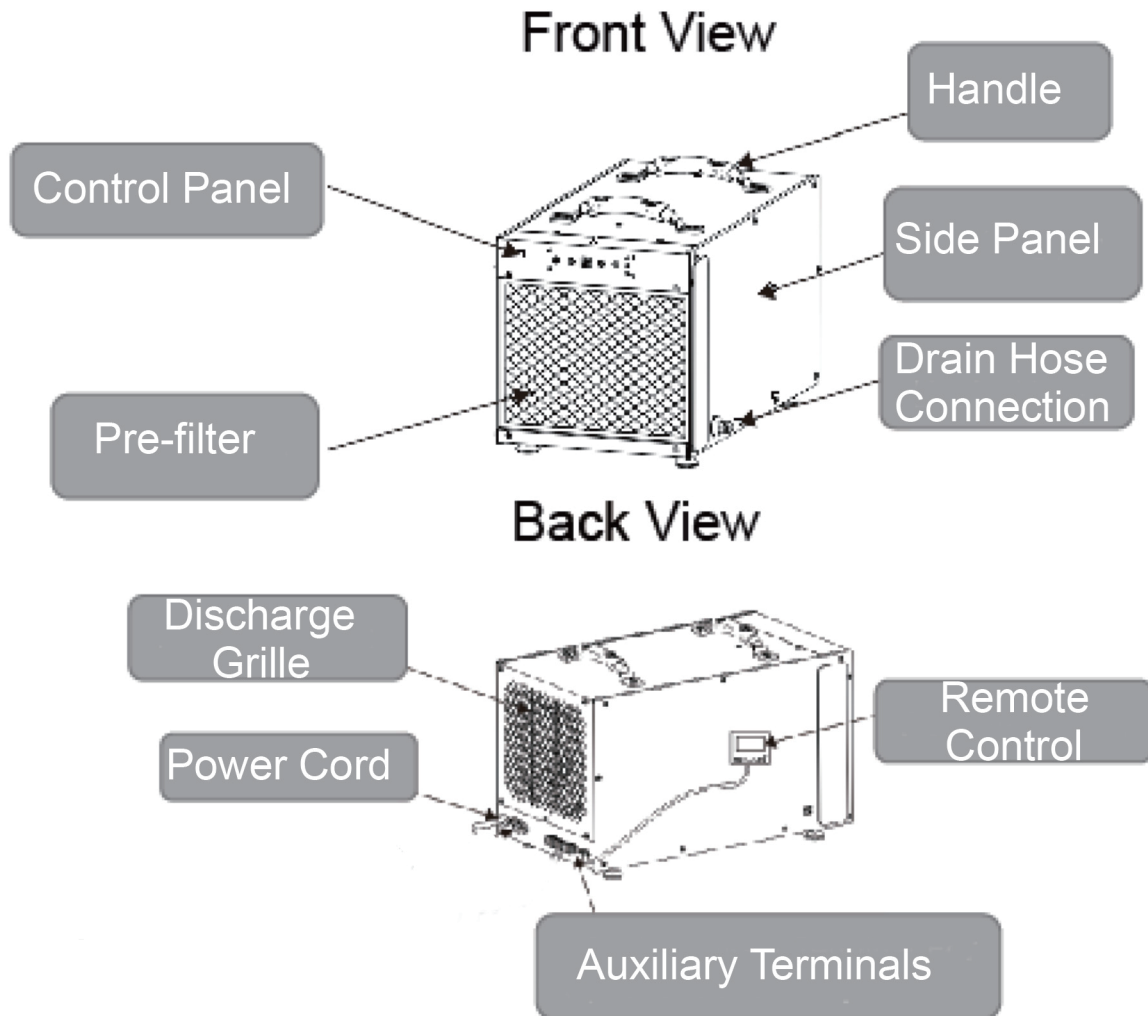

Maintenance

For more detailed instructions, visit www.SeairaGlobal.com

WARNING: Always unplug the unit before doing any maintenance.

Cleaning the Machine Body

- Use a soft, damp cloth to clean the exterior of unit. Do not use any soap or solvents

Coil Maintenance

- Once per year, clean the coils with an approved coil cleaner. The coil cleaner should be a self-rinsing, foaming, cleaner, such as WEB® Coil Cleaner.

Cleaning the Filter

1. Unplug the unit.
2. For PreFilter:
 - a. Remove prefilter from inlet of machine.
 - b. Vacuum or wash with warm water (no soap).
3. For MERV-10/HEPA/Carbon Filters:
 - a. Replace as necessary- we recommend checking the filter at least 1x/year

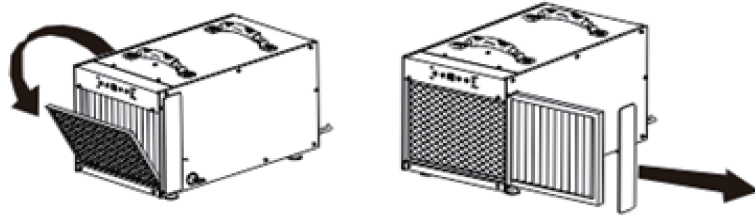

Electrical Access

- Unscrew the 9 screws on the side board
- Remove the 2 screws on the control board cover.

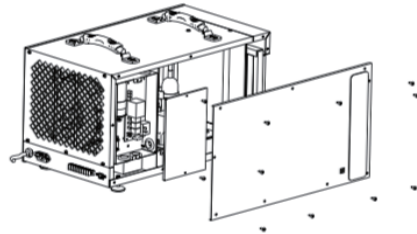

Cleaning the Gravity Drain

Complete about once per year, depending on environment

- Mix a 16 ounce solution of bleach (1 oz bleach + 15 oz water) OR vinegar (4 oz white vinegar + 12 oz water).
 - Remove filter(s) so you have access to the drain tray.
 - Disconnect power to dehumidifier.
 - Pour the cleaning solution into the drain tray at the base of the coils.
- If any cleaning solution gets on the coils, flush with water.
- Allow solution to soak for 15 minutes.
 - Pour in 16-32 ounces of clean water to flush out the drain line.

Dehumidifier Storage

If the unit will be stored for an extended period of time, complete the following steps:

1. Turn off the unit and allow it to dry.
2. Wrap and secure the power cord.
3. Cover the filter mesh.
4. Store in a clean, dry space.

Ducted Applications

Ducting the dehumidifier allows the unit to be in one room while conditioning an adjacent room. Both the inlet/return grille and the supply grille are designed for 10" flex ducting.

Ducting Installation Notes

- Be sure to secure the ducting with tie wrap.
- Maximum total length of duct run = 10'
- Inlet and outlet duct adapters are optional accessories

Duct Adapter Installation

- Screw in the 4 screws on each duct adapter.

Flex Duct Installation

- Slide ducting over adapter and secure with tie wrap or clamps

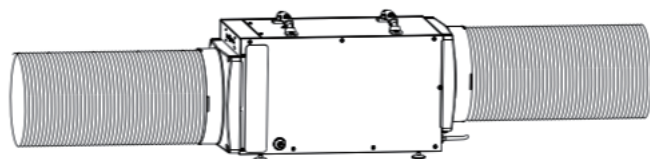

Troubleshooting

Symptom	Cause	Solution
Display is Blank	Poor Connection	Verify that both ends of the power cord are plugged in
	Power Outage	Reset power
No Airflow	Filter is Dirty	Clean the filter
	Air Inlet or Outlet is Blocked	Clear the blockage
Error Code: E1	Humidity Sensor or Communication Error	Check to ensure that the sensor wire is connected at both ends. if no issues are visible, the sensor may be faulty.
Error Code: E4	Problem with Pump	Verify that the pump is properly installed and functioning. If so, unplug the unit for two minutes, then restart.
Error Code: LO	Room Temperature is below 33°F	Increase the room temperature so it is within operating range (above 33°F). If error still displays, check sensor.
Error Code: HI	Room Temperature is above 105°F	Decrease the room temperature so it is within operating range (below 105°F). If error still displays, check the sensor
Tripped GFCI Outlet or Breaker	Not a Dedicated Circuit	Identify all sources connected to outlet and confirm source of trip. If it is dehumidifier, contact technical support. If not, move dehumidifier to dedicated circuit for future use.
	Defective GFCI Outlet	Replace Outlet
	Dirt, Dust, or Moisture on Outlet	Clean or Replace Outlet, as necessary
	Lightning or External Electrical Surge	Reset or Replace Breaker/GFCI, as necessary
	Possible Dehumidifier Issue	If none of above options work, contact technical support

Spare Parts

Remote Control	
W-100	Remote Control Assembly

Duct + Ventilation Accessories	
N-103	WatchDog Return + Supply Duct Collar Assembly

Installation Accessories	
W-112	WatchDog Hanging Kit

Replacement Filters	
N-200	WatchDog Prefilter
N-201	WatchDog MERV 10
N-202	WatchDog HEPA
N-203	Carbon Filter

Limited Warranty

All warranty benefits apply to the original owner only. Warranty cannot be transferred or assigned.

5 Years (From Date of Purchase):

Seaira Global warrants the dehumidifier will operate free of defects in workmanship and materials. At its discretion, Seaira will repair or replace any malfunctioning components, free of charge (excluding transportation costs)

Customer Responsibilities:

In order to take advantage of the warranty service, the customer must do the following:

Customer must provide normal care and maintenance (including, but not limited to cleaning filters, coils and pumps)

2. Removal and re-installation of unit is the sole responsibility of owner.

3. If customer cannot return unit to certified repair center, all costs associated with freight shipment are borne by the customer. In addition, all ancillary charges related to freight shipments, including but not limited to palletizing, wrapping, labeling, and pickup are associated with the customer.

4. If shipped, customer is responsible for all risk of loss or damage.

Warranty Procedure:

1. Customer must mail in warranty registration card to Seaira Global. If no card is submitted, warranty period will begin the day the shipment left the warehouse. Please be sure to record serial # and date of installation in the spaces provided on page 2 of the manual. You will need this information to receive an RA number.

2. If warranty service is necessary, customer must contact Seaira Global Tech Support by phone 910-660-0962 to receive a Return Authorization (RA number).

3. Once an RA has been issued, it is the customer's job to bring the unit to a certified repair center. If this is not an option, shipping will be arranged to bring the unit back to the Seaira warehouse (at the expense of the customer).

4. After the unit has been received by Seaira (whether at a repair center or the warehouse), an initial inspection will be completed, if it is determined to be an invalid warranty claim (see exclusions below), unit will only be completed after receiving payment from customer for all associated costs.

5. If unit is defective, the necessary parts will be repaired or replaced and the unit will be available for pickup at certified repair center or returned via freight shipment (at customer's expense). Keep in mind that work is only done during normal working hours. After being repaired, all units are required to go through a rigorous testing process prior to being returned to customer.

6. Once a part is repaired and the dehumidifier is returned, the original warranty period still applies (no extensions).

Warranty Exclusions

THE FOLLOWING IS NOT COVERED UNDER WARRANTY

1. ACTS OF NATURE- INCLUDING BUT NOT LIMITED TO:
 - FLOODING
 - FIRE
 - WATER DAMAGE
 - HURRICANE/STORM DAMAGE
2. IMPROPER USAGE- INCLUDING BUT NOT LIMITED TO:
 - POOL/SPA/TUB APPLICATIONS
 - MISUSE, ABUSE, OR TAMPERING WHETHER INTENTIONAL OR ACCIDENTAL
 - IMPROPER INSTALLATION OR DESIGN
 - IMPROPER VOLTAGE
 - LACK OF NORMAL CARE
 - FAILURE TO FOLLOW INSTRUCTIONS
3. CORROSION
4. FREEZING
5. ANY ADDITIONAL COSTS DUE TO CHANGES IN LAWS OR BUILDING CODES
6. FREIGHT CHARGES
7. ANY COSTS DUE TO LOST PROFIT OR DELAY
8. DAMAGE TO PROPERTY
9. CAUSE BEYOND CONTROL
10. CONSUMABLE PARTS, INCLUDING BUT NOT LIMITED TO:
 - FILTERS
 - BATTERIES
 - POWER CORDS
 - VALVES
 - SWITCHES
 - RUBBER PARTS
11. APPLICABLE LAW AND VENUE

ALL ASPECTS OF THIS AGREEMENT SHALL BE INTERPRETED BY AND UNDER THE LAWS OF THE STATE OF NORTH CAROLINA. ANY LITIGATION, ENFORCEMENT OF ARBITRATION, OR LITIGATION RELATED TO SHALL BE BROUGHT IN THE APPROPRIATE COURT IN NEW HANOVER COUNTY, NORTH CAROLINA.

12. DIRECT, INDIRECT, COLLATERAL OR INCONSEQUENTIAL DAMAGES OF ANY KIND

THE WARRANTIES AND LIABILITIES SET FORTH ARE IN LIEU OF ALL OTHER WARRANTIES EXPRESSED OR IMPLIED, IN LAW OR IN FACT, INCLUDING IMPLIED WARRANTIES OF MERCHANTABILITY AND FITNESS FOR PARTICULAR PURPOSE. SEAIRA GLOBAL'S TOTAL LIABILITY, REGARDLESS OF NATURE OF CLAIM SHALL NOT EXCEED ORIGINAL PURCHASE PRICE OF THE PRODUCT. IF A PRODUCT OR COMPONENT IS REPLACED WHILE UNDER WARRANTY, THE APPLICABLE WARRANTY PERIOD SHALL NOT BE EXTENDED BEYOND THE ORIGINAL WARRANTY TIME PERIOD.

THE FOREGOING SHALL CONSTITUTE THE TOTAL LIABILITY OF SELLER IN THE CASE OF DEFECTIVE PERFORMANCE OF ALL OR ANY OF THE EQUIPMENT OR SERVICES PROVIDED TO BUYER. BUYER AGREES TO ACCEPT AND HEREBY ACCEPTS THE FOREGOING AS THE SOLE AND EXCLUSIVE REMEDY FOR ANY BREACH OR ALLEGED BREACH OF WARRANTY BY SELLER.

ANY DISHONESTY OR FRAUD IN CONNECTION WITH SEAIRA GLOBAL WARRANTY THOROUGHLY VOIDS ALL WARRANTY POLICIES. SEAIRA GLOBAL EXPRESSLY RESERVES THE RIGHT TO PURSUE LEGAL ACTION IN THE EVENT OF DISHONESTY, FRAUD, OR ATTEMPTED FRAUD.

