

INSTALLATION GUIDE

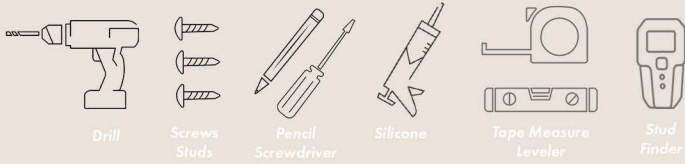

⚠ Make sure your wall is suitable for wall mounting! You may need to reinforce your wall before installing your new sink.
Installing a wall mount sink requires plumbing knowledge. You will need to consult a professional to make sure your rough in is up to code.
WARNING: To prevent damaging the sealant on your sink, do not use tape on its surface.

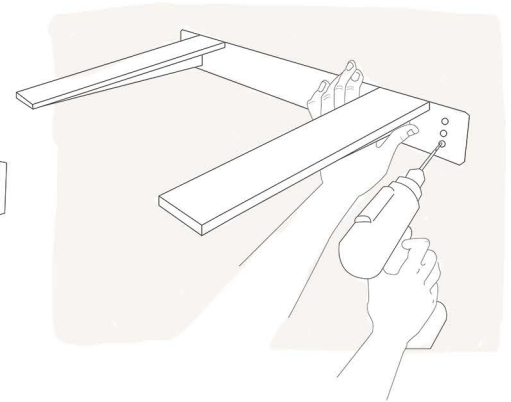
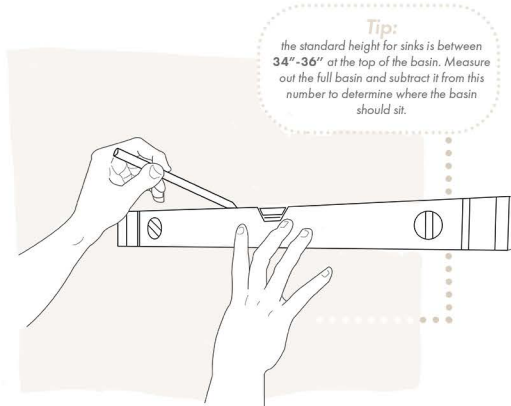
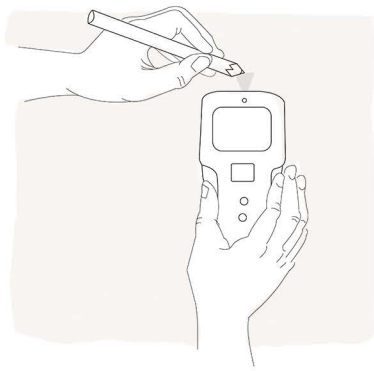

1 Use the studfinder to find a suitable fixing point for your brackets. Then measure where you want the bottom of the basin to go, as well as the center of the sink.

2 Remark the area where the bottom of your basin will go with a level and pencil. This will be your guide as to where the top of the bracket will sit.

3 Hold the bracket up to the line and mark the holes with a pencil. Once you are sure the placement is correct, affix the bracket onto your wall with the correct bolts for your wall.

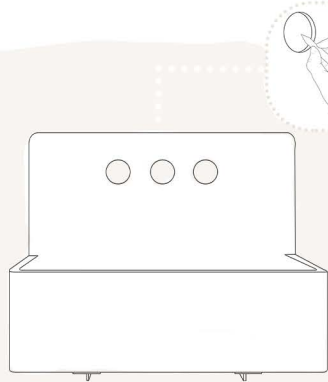

Tip:
After marking, remember to consult a professional about rough in valve installation before moving on.

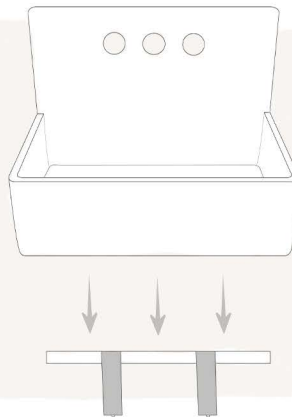

Tip:
Rough in should be visible through the holes drilled in the back splash.

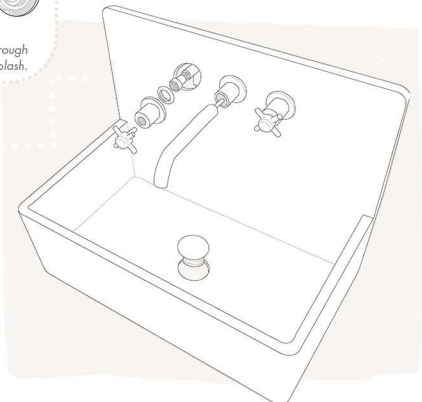

4 Place sink on bracket to accurately mark faucet holes with pencil. Do not glue down yet! After marking, remove sink and consult professional for rough in installation.

5 Once rough in valve installation is complete, apply a generous amount of 100% silicone to top of bracket. Place sink on top, making sure it is aligned with rough in for faucet. Remove any excess silicone with microfiber towel.

6 Once silicone is dried and sink is tightly secured to wall bracket, you may finish attaching faucet, drain, and bottle trap.