



(12) **United States Design Patent**
Busch

(10) **Patent No.:** **US D683,951 S**
(45) **Date of Patent:** **** Jun. 11, 2013**

- (54) **POCKET KEY ORGANIZER**
- (71) Applicant: **BladeKey LLC**, Tempe, AZ (US)
- (72) Inventor: **James David Busch**, Tempe, AZ (US)
- (73) Assignee: **BladeKey LLC**, Tempe, AZ (US)
- (**) Term: **14 Years**
- (21) Appl. No.: **29/438,466**
- (22) Filed: **Nov. 30, 2012**

Related U.S. Application Data

- (63) Continuation of application No. 29/406,366, filed on Nov. 13, 2011, now Pat. No. Des. 674,590.
- (51) **LOC (9) Cl.** **03-01**
- (52) **U.S. Cl.**
USPC **D3/207**
- (58) **Field of Classification Search**
USPC D3/207-212; D11/31-33, 44, 48-51,
D11/66, 79-85, 94-116; 70/456 R, 456 B,
70/457-460; 24/3.6; D13/168; 362/116; D8/348
See application file for complete search history.

References Cited

- (56) **U.S. PATENT DOCUMENTS**
D3,942 S 3/1870 Elwell
1,885,957 A 11/1932 Singleton
(Continued)
- OTHER PUBLICATIONS**
Jag-Engr, "Consolidated Pocket& Keychain Organization Thread,"
EDCForums (Nov. 24, 2011).
(Continued)

(74) *Attorney, Agent, or Firm* — James David Busch
(57) **CLAIM**
I claim the ornamental design for a pocket key organizer, substantially as shown and described.

DESCRIPTION

FIG. 1 is a front perspective view of a pocket key organizer showing my new design;
FIG. 2 is a front view;
FIG. 3 is a rear view;
FIG. 4 is a left side view;
FIG. 5 is right side view;
FIG. 6 is a top view;
FIG. 7 is a bottom view;
FIG. 8 is a front view of a pocket key organizer showing a second embodiment of my new design;
FIG. 9 is a front view of FIG. 8;
FIG. 10 is a rear view of FIG. 8;
FIG. 11 is a left side view of FIG. 8;
FIG. 12 is a right side view of FIG. 8;
FIG. 13 is a top view of FIG. 8;
FIG. 14 is a bottom view of FIG. 8;
FIG. 15 is a front view of a pocket key organizer showing a third embodiment of my new design;
FIG. 16 is a front view of FIG. 15;
FIG. 17 is a rear view of FIG. 15;
FIG. 18 is a left side view of FIG. 15;
FIG. 19 is a right side view of FIG. 15;
FIG. 20 is a top view of FIG. 15;
FIG. 21 is a bottom view of FIG. 15;
FIG. 22 is a left side view of any of the embodiments shown in a position of use with a key; and,
FIG. 23 is a left side view of any of the embodiments shown in a position of use with a key extended.
The features shown in broken lines in the various Figures are for illustrating the environmental structure and form no part of the claimed design.

Primary Examiner — Ralf Seifert

1 Claim, 7 Drawing Sheets

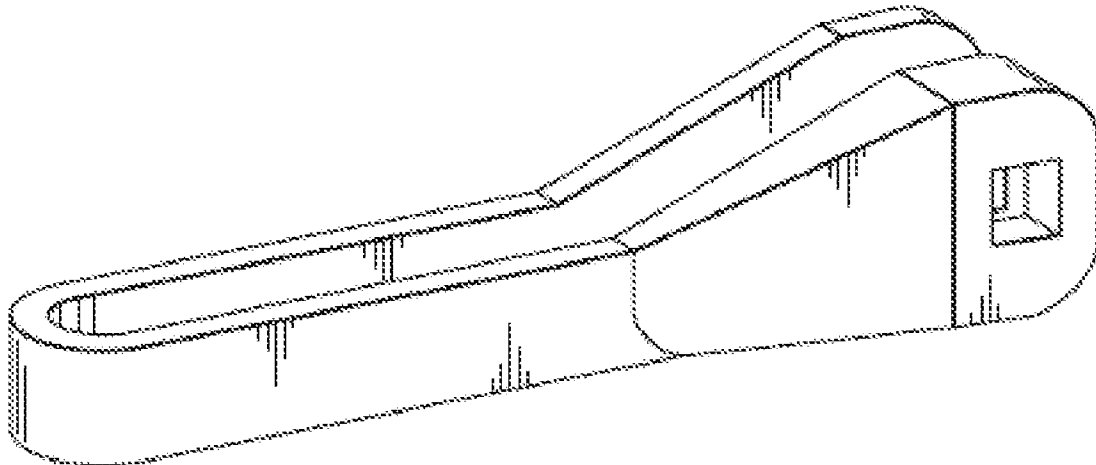

U.S. PATENT DOCUMENTS

1,922,755	A	8/1933	Buxton	5,704,236	A	1/1998	Parsons
2,038,070	A	4/1936	Welch	5,711,194	A	1/1998	Anderson
2,228,726	A	1/1941	Loesch	5,732,579	A	3/1998	D'Hont et al.
2,344,581	A	3/1944	Ziegeweid	5,768,925	A	6/1998	Ozawa et al.
D156,677	S	5/1948	Smith	5,791,211	A	8/1998	Bondhus et al.
2,482,623	A	9/1949	Kaminer	D404,284	S	1/1999	Sacco et al.
2,514,940	A	7/1950	Hogue	D405,675	S	2/1999	Rivera
2,547,340	A	4/1951	Mullan	D415,343	S	10/1999	Maddox
2,547,524	A	4/1951	Gross	6,016,676	A	1/2000	McConnell
2,583,961	A	1/1952	Nash	D423,209	S	4/2000	Guyot
2,600,749	A	6/1952	Gallagher	D427,501	S	7/2000	Berg et al.
2,625,814	A	1/1953	Mullan	6,106,131	A	8/2000	Hao
2,637,994	A	5/1953	Harrison	D434,302	S	11/2000	Van Den Acker
2,659,231	A	11/1953	Glubiak	6,164,102	A	12/2000	Gapco
2,699,667	A	1/1955	Mark	D442,060	S	5/2001	Neset
2,836,053	A	5/1958	Slarreit	D442,061	S	5/2001	Harris et al.
2,869,232	A	1/1959	Kivela	D442,466	S	5/2001	Van Den Acker
2,882,710	A	4/1959	Furn	6,282,996	B1	9/2001	Berg et al.
D185,686	S	7/1959	Tronson	D473,710	S	4/2003	Szilva
2,931,208	A	4/1960	Prim	D478,207	S	8/2003	Johnson
2,964,937	A	12/1960	Laufin	6,684,673	B2	2/2004	Florendo
2,969,668	A	1/1961	Aitchison	6,763,938	B1	7/2004	Nelson
2,978,897	A	4/1961	Capitani	6,892,558	B2	5/2005	Chodosh
2,989,861	A	6/1961	Schefman	D514,310	S	2/2006	Roye
3,004,422	A	10/1961	Starrett	7,032,419	B2	4/2006	Booker
3,277,680	A	10/1966	Merila	7,127,922	B2	10/2006	Khounsombath et al.
3,299,930	A	1/1967	Schumer	D539,526	S	4/2007	Stein
3,355,917	A	12/1967	Albert	D593,318	S *	6/2009	Kellegghan D3/207
3,363,440	A	1/1968	Rivers	D624,305	S	9/2010	Downes
3,394,565	A	7/1968	Turman	D665,992	S *	8/2012	Wilbur D3/207
3,407,636	A	10/1968	Kovacevic	2011/0016937	A1	1/2011	Downes
3,421,349	A	1/1969	St. Clair				
3,455,131	A	7/1969	Shofner				
3,527,072	A	9/1970	Demetreon				
3,606,777	A	9/1971	Watson				
3,672,192	A	6/1972	Dontas				
3,677,044	A	7/1972	De Frees				
3,696,649	A	10/1972	Chow et al.				
D237,561	S	11/1975	Kesner				
3,931,688	A	1/1976	Owens				
D248,960	S	8/1978	Iverson				
4,297,864	A	11/1981	Beier				
4,351,173	A	9/1982	Toyoda				
4,417,612	A	11/1983	Couture et al.				
4,454,737	A	6/1984	Toyoda				
4,524,594	A	6/1985	Bascou				
4,569,215	A	2/1986	McCarthy				
4,571,967	A	2/1986	Jacobsen				
4,658,479	A	4/1987	Sanders				
4,901,547	A	2/1990	Dal Palu'				
4,939,917	A	7/1990	Cartwright				
4,941,569	A	7/1990	Lindmayer et al.				
4,951,489	A	8/1990	Proch				
D332,384	S	1/1993	Dague				
D334,528	S	4/1993	Franklin				
5,199,560	A	4/1993	Lee et al.				
5,207,082	A	5/1993	LeMaitre				
D356,019	S	3/1995	Sakai				
D357,166	S	4/1995	Concari				
5,460,022	A	10/1995	Parsons				
D364,269	S	11/1995	Sabosky				
5,544,510	A	8/1996	Botteon et al.				
5,568,741	A	10/1996	Parsons				
D382,190	S	8/1997	Blakston et al.				
5,704,235	A	1/1998	Stahle				

OTHER PUBLICATIONS

Ethanf, "Do you hate your keys jingling? (Bicycle Content)," EDCForums (Sep. 12, 2011).
 Anonymous, "Products," Down Home Leather, Nov. 24, 2011.
 Anonymous, "Novel Key Holder," Popular Mechanics at p. 161 (Jan. 1923).
 Anonymous, "Key & Holders," Able Home Aides (Nov. 24, 2011).
 Crew, "My new custom 'multi-key', made from a Gerber Curve!," EDCForums (Dec. 1, 2010).
 Legoman0721, "Cold Steel Mini Tac Tanto," EDCForums (Nov. 24, 2010).
 Aphi, "Switchkey," EDCForums (Dec. 19, 2010).
 Shadeone, "The Real Leatherman KEYman! My custom Multi-Key!!," EDCForums (Aug. 6, 2007).
 Anonymous, "Master Key Set," T-Parts (Date Unknown).
 Anonymous, "True Utility® Keyring System," True Utility (Date Unknown).
 Dieck, "Ultra Ultra minimalist keyring," EDCForums (May 29, 2008).
 Diaz, Oscar, "While u sleep," Oscar Diaz Studio (Date Unknown).
 Wild Style, "wild style's daily carry," EDCForums (Oct. 21, 2009).
 Anonymous, "Carrying Keys," Carryology (Jun. 3, 2010).
 Busch, "Photo Set 1," (Jul. 8, 2007).
 Busch, "Photo Set 2," (Jul. 8, 2007).
 F3RG, "Crank Bros. Folding Keychain," Mtbr Forums (Jan. 29, 2009).
 Anonymous, "Photo of Keys" (Date Unknown).
 PYRO222, "Multi-tool Keys—Mod/Hack," Instructables (Jul. 20, 2008).
 Anonymous, "Compact Key Chain," Sagawisiw (Jun. 10, 2012).

* cited by examiner

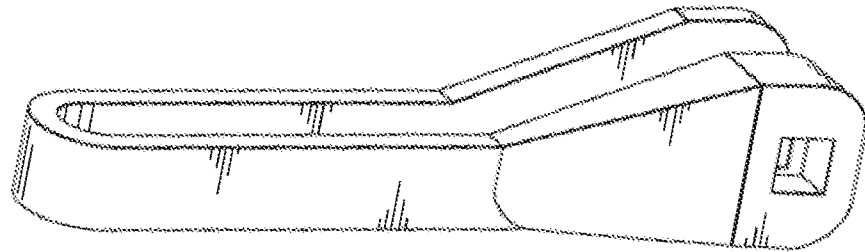

FIG. 1

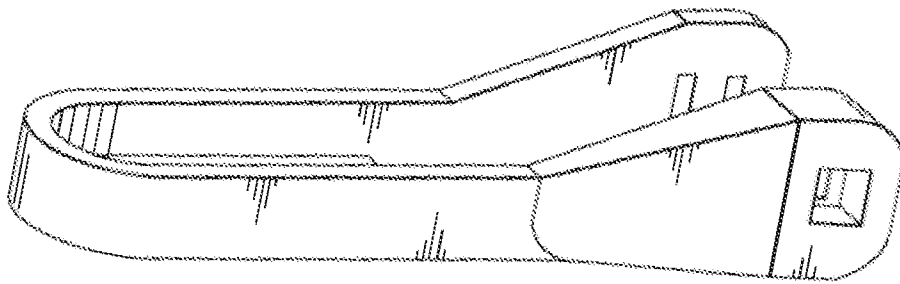

FIG. 8

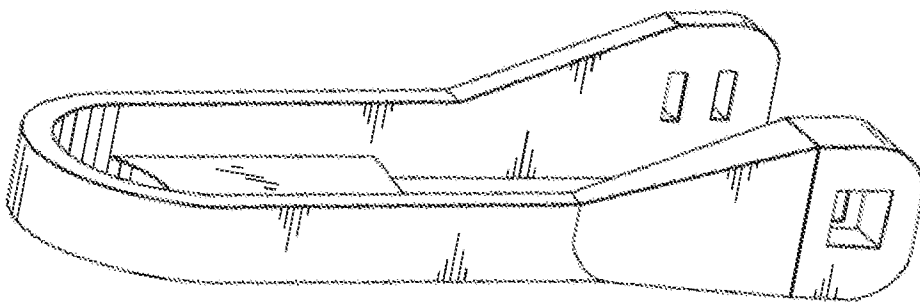

FIG. 15

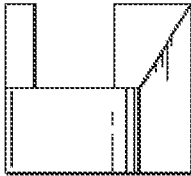

FIG. 2

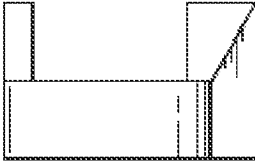

FIG. 9



FIG. 16

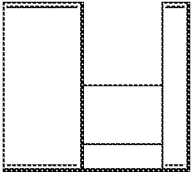

FIG. 3

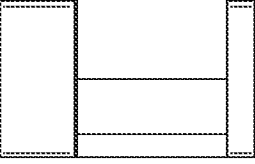

FIG. 10

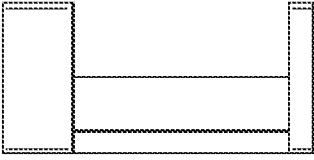

FIG. 17

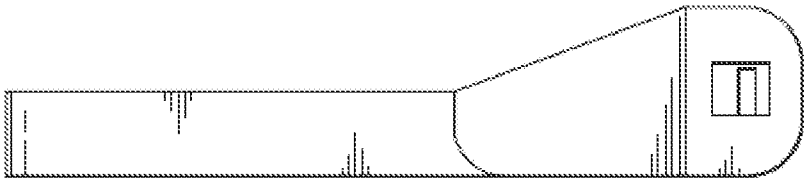

FIG. 4

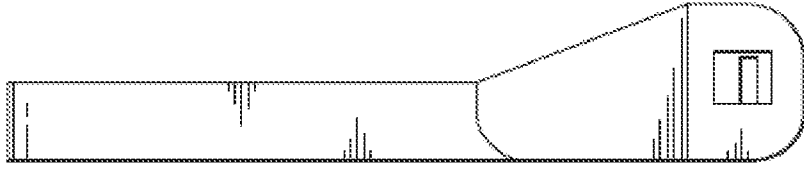

FIG. 11

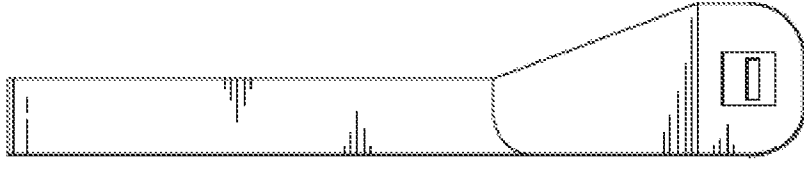

FIG. 18

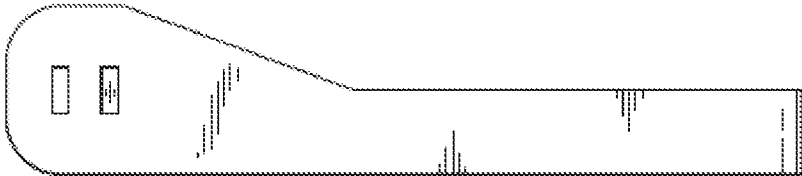

FIG. 5

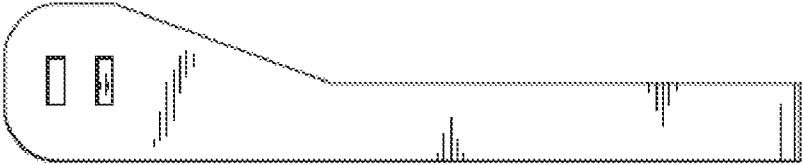

FIG. 12

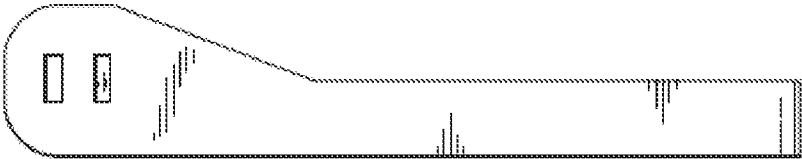

FIG. 19

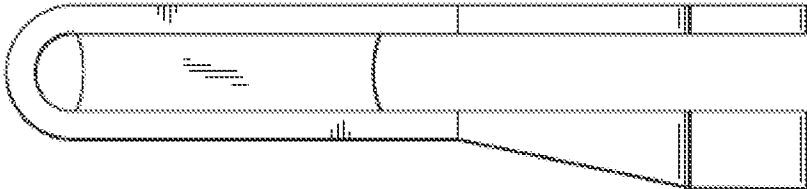

FIG. 6

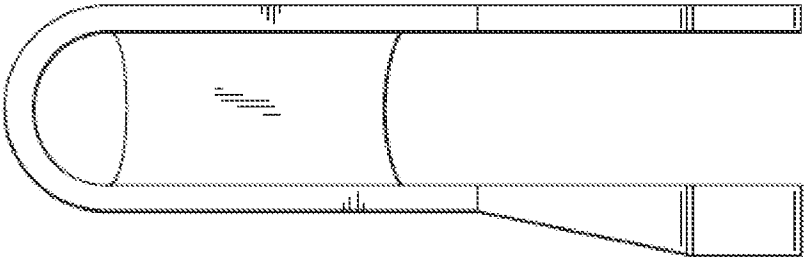

FIG. 13

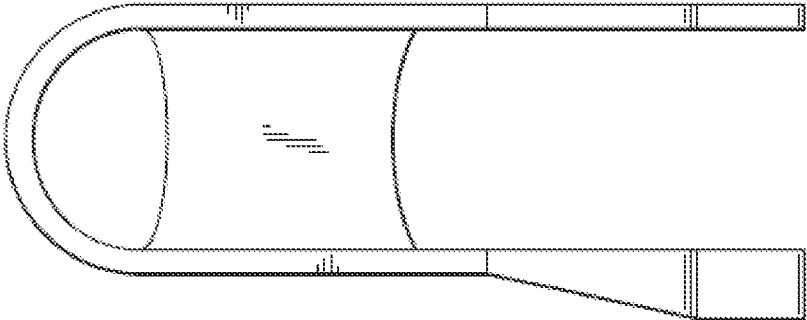

FIG. 20

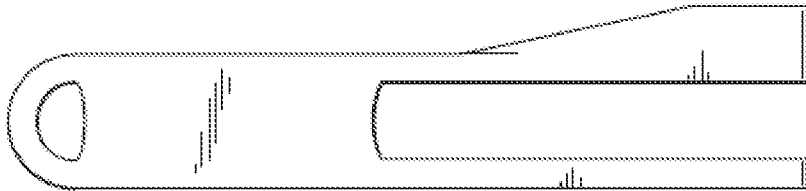

FIG. 7

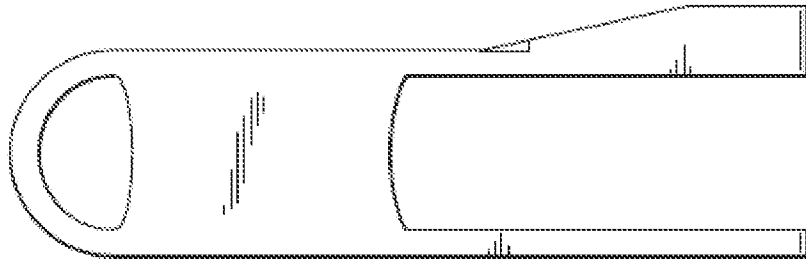

FIG. 14

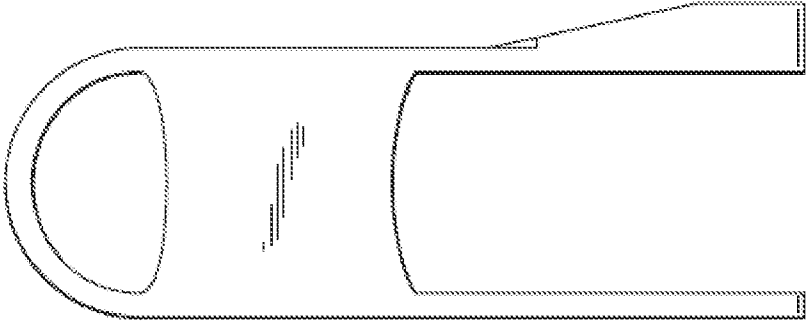

FIG. 21

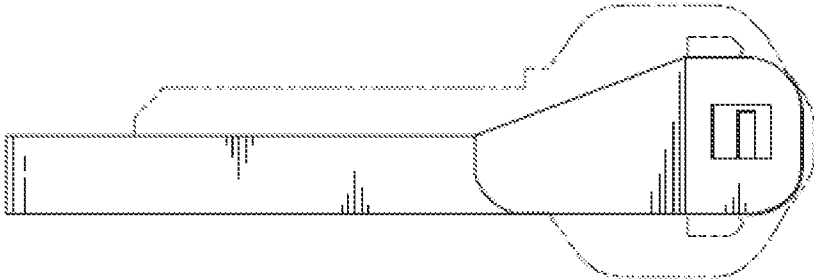

FIG. 22

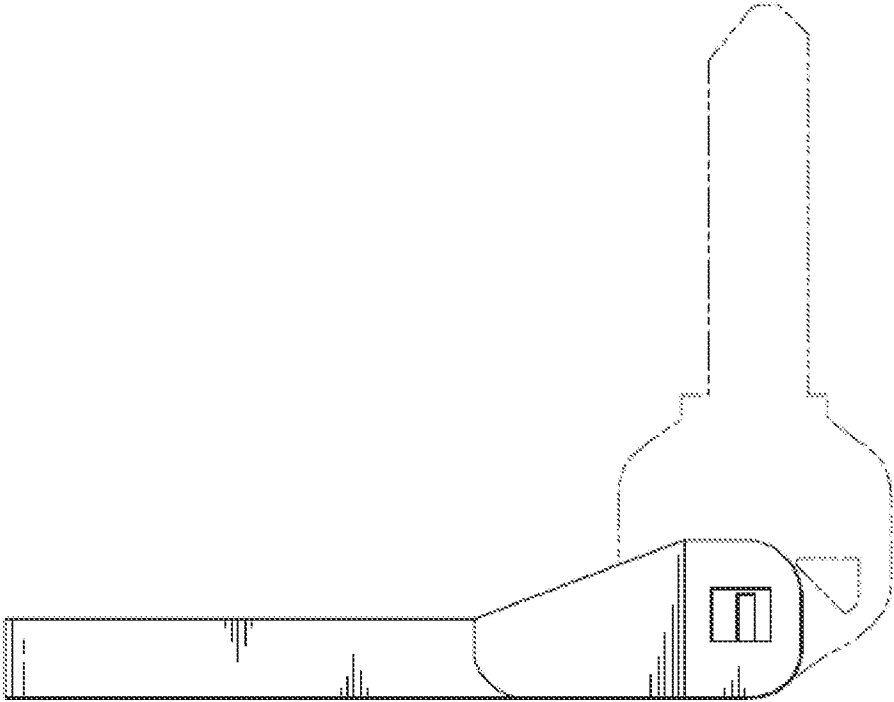

FIG. 23