



Project \_\_\_\_\_

Item No. \_\_\_\_\_

Quantity \_\_\_\_\_

# HIGH h CONVEYOR 2020™



### PERFORMANCE

- The High h Conveyor 2020 offers high-heat transfer rates for accelerated cooking, a small enough footprint to fit virtually any application, and does not require the energy consumption and higher HVAC needs of larger ovens.

### VENTILATION

- UL (KNLZ) listed for ventless operation.†
- EPA 202 test (8 hr):
  - Product: Pepperoni Pizza  
Results: 1.05 mg/m<sup>3</sup>
  - Product: Sandwiches  
Results: 1.91 mg/m<sup>3</sup>  
Ventless Requirement: <5.00 mg/m<sup>3</sup>
- Internal catalytic filtration to limit smoke, grease, and odor emissions.

### EXTERIOR CONSTRUCTION

- 430 stainless steel front, top, sides and back
- Cool to touch covers and panels

### INTERIOR CONSTRUCTION

- Stainless steel interior
- 20-inch cook chamber

### STANDARD FEATURES

- Small footprint with throughput exceeding other 28-inch conveyors
- Independently-controlled top and bottom air impingement
- Variable-speed High h recirculating impingement airflow system
- Stackable design up to 3 high (requires stacking kits)
- Variable-speed blower motors
- Easy to clean mono-finger design
- Idle mode for energy conservation
- Built-in self diagnostics for monitoring oven components
- Left or right feed conveyor belt direction via software
- Includes plug and cord (6 ft. nominal)
- Includes two 6" conveyor extensions
- Warranty – one year parts and labor
- Smart voltage sensor technology (U.S. only)

### OPTIONAL FEATURES

- Split belt with individually-adjustable speed settings (split 50/50 and 70/30)
- Dual catalytic converters for ventless operation.†

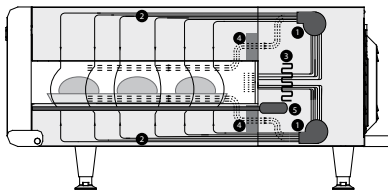

1. Blower Motor
2. Impinging Air
3. Impingement Heater
4. Catalytic Converters (optional)
5. Conveyor Motor



This product conforms to the ventilation recommendations set forth by NFPA96 using EPA202 test method.

† Ventless certification is for all food items except for foods classified as "fatty raw proteins." Such foods include bone-in, skin-on chicken, raw hamburger meat, raw bacon, raw sausage, steaks, etc. If cooking these types of foods, consult local HVAC codes and authorities to ensure compliance with ventilation requirements.

Ultimate ventless allowance is dependent upon AHJ approval, as some jurisdictions may not recognize the UL certification or application. If you have questions regarding ventless certifications or local codes please email [ventless.help@turbochef.com](mailto:ventless.help@turbochef.com)

TurboChef reserves the right to make substitutions of components or change specifications without prior notice.

DIMENSIONS		
<b>SINGLE UNITS</b>		
Height	17.0"	432 mm
Width	48.3"	1227 mm
Depth	35.7"	907 mm
Weight	195 lbs.	88.5 kg
<b>Cook Chamber</b>		
Baking Area	2.8 ft <sup>2</sup>	0.26 m <sup>2</sup>
Belt Length	48.3"	1227 mm
Belt Width (Single)	20"	508 mm
Belt Width (50/50 Split)	9.5" / 9.5"	241 mm / 241 mm
Belt Width (70/30 Split)	15" / 4"	381 mm / 102 mm
Adjustable Opening (Min/Max)	1" / 3"	25 mm / 76 mm
Max Operating Temp	550°F	288°C
Bake Time Range	30 seconds to 15 minutes	
<b>Wall Clearance</b>		
Top	10"	254 mm
Sides	0"	0 mm
Back	0"	0 mm
SHIPPING INFORMATION		
<b>U.S.:</b> All ovens shipped within the U.S. are packaged in a double-wall corrugated box banded to a wooden skid. <b>International:</b> All International ovens shipped via Air or Less than Container Loads are packaged in wooden crates.		
<b>Box size:</b> 55" (1,397 mm) x 43" (1,092 mm) x 27" (686 mm) <b>Crate size:</b> 58" (1,473 mm) x 46" (1,168 mm) x 28" (711 mm) <b>Item class:</b> 85 NMFC #26770 HS code 8419.81		
<b>Approximate boxed weight:</b> 300 lb. (136 kg) <b>Approximate crated weight:</b> 410 lb. (186 kg)		
<b>Minimum entry clearance required for box:</b> 27.5" (699 mm) <b>Minimum entry clearance required for crate:</b> 28.5" (724 mm)		

SEE OPPOSITE SIDE FOR ILLUSTRATIONS

**TurboChef Global Operations**  
 2801 Trade Center Drive  
 Carrollton, Texas 75007 USA  
 US: 800.90TURBO (800.908.8726)  
 International: +1 214.379.6000  
 Fax: +1 214.379.6073  
 turbochef.com

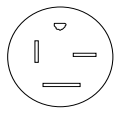
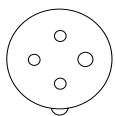
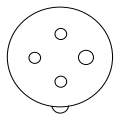
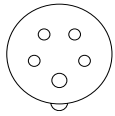
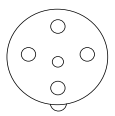
ELECTRICAL SPECIFICATIONS - USA		
HCT-4215-1 (Single Belt) HCT-4215-4 (50 / 50 Split Belt) HCT-4215-7 (70 / 30 Split Belt) HCT-4215-16 (65 / 35 Split Belt)		 NEMA 15-50P
Phase	3 Phase	
Voltage	208/240 VAC	
Frequency	50/60 Hz	
Current Draw	40 Amp	
Supply	4 Wire	
Breakers	50 Amp	
ELECTRICAL SPECIFICATIONS - CANADA		
HCT-4215-10C (Single Belt) HCT-4215-11C (50 / 50 Split Belt) HCT-4215-12C (70 / 30 Split Belt)		 UL 4 Pin, 60 Amp
Phase	3 Phase	
Voltage	208/240 VAC	
Frequency	50/60 Hz	
Current Draw	40/46 Amp	
Supply	4 Wire	
Breakers	50/60 Amp	
ELECTRICAL SPECIFICATIONS - EUROPE/ASIA (DELTA)		
HCT-4215-2D (Single Belt) HCT-4215-5D (50 / 50 Split Belt) HCT-4215-8D (70 / 30 Split Belt) HCT-4215-24D (65 / 35 Split Belt)		 IEC 4 Pin, 63 Amp
Phase	3 Phase	
Voltage	220 - 240 VAC	
Frequency	50/60 Hz	
Current Draw	40 Amp	
Supply	4 Wire	
Breakers	50 Amp	
ELECTRICAL SPECIFICATIONS - EUROPE/ASIA (WYE)		
HCT-4215-3W (Single Belt) HCT-4215-6W (50 / 50 Split Belt) HCT-4215-9W (70 / 30 Split Belt) HCT-4215-23W (65 / 35 Split Belt)		 IEC 5 Pin, 32 Amp
Phase	3 Phase	
Voltage	380 - 415 VAC	
Frequency	50/60 Hz	
Current Draw	20 Amp	
Supply	5 Wire	
Breakers	32 Amp	
ELECTRICAL SPECIFICATIONS - AUSTRALIA		
HCT-4215-20W (Single Belt) HCT-4215-21W (50 / 50 Split Belt) HCT-4215-22W (70 / 30 Split Belt)		 IEC 5 Pin, 32 Amp
Phase	3 Phase	
Voltage	380 - 415 VAC	
Frequency	50/60 Hz	
Current Draw	20 Amp	
Supply	5 Wire	
Breakers	32 Amp	

Note: To specify a ventless model on an oven order, add a "-V" to the end of the applicable part numbers listed above.



Front View

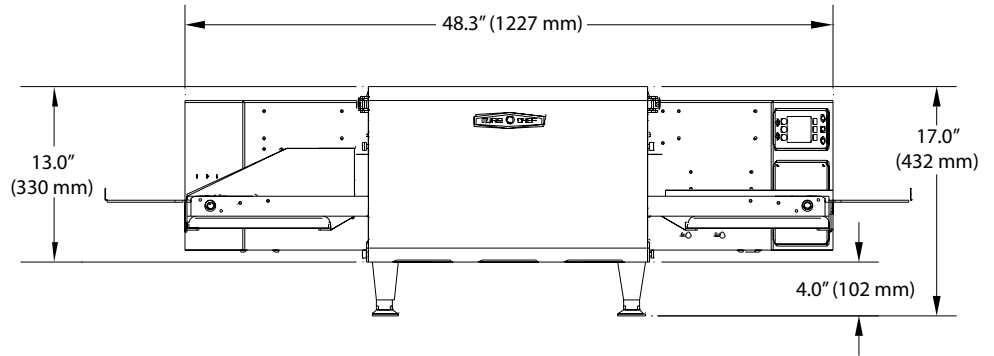

Side View

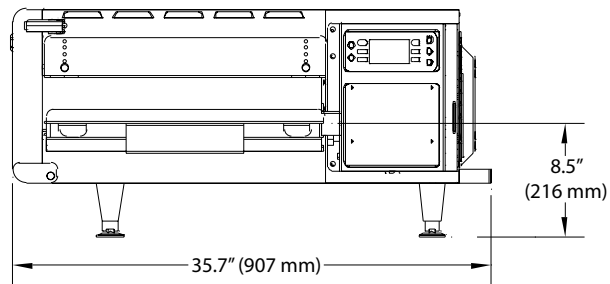

Top View

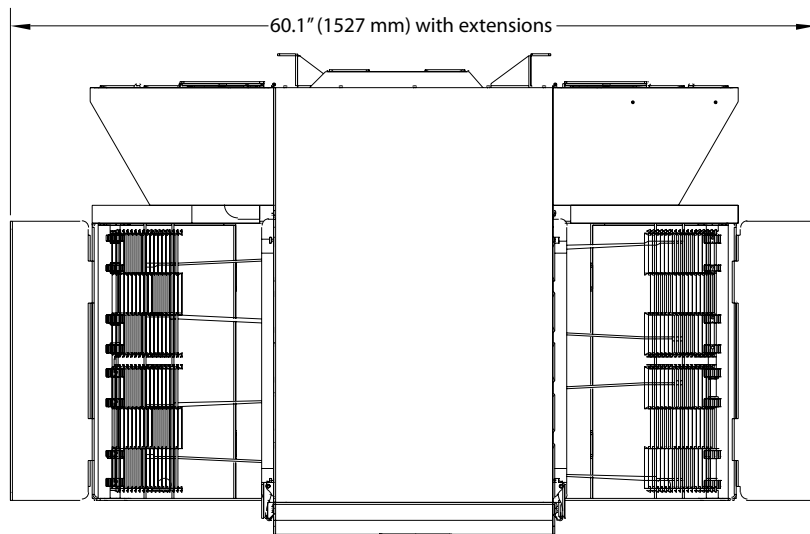



## Stacked Views

