

New Size, New Standard! The GLT-80/100 Power Tilt is Now Available.

GAS STEAM TILTING KETTLE



GLT-100 shown

- GLT-80
- GLT-100

OPERATION SHALL BE BY:

High efficiency power burner system for operation on 120 VAC, 1 Phase, 50/60 Hz.

- Natural gas
- L.P. gas

OPTIONS & ACCESSORIES AT ADDITIONAL COST

- | | | |
|---|--|---|
| <input type="checkbox"/> 220-240 VAC operation (specify voltage)(GKVS-1) | <input type="checkbox"/> Etched litre markings (LM-) | <input type="checkbox"/> Graduated measuring strip (CMS-) |
| <input type="checkbox"/> Spring assist stainless steel cover (CH-) | <input type="checkbox"/> Single pantry faucet with swing spout (SF-18) | <input type="checkbox"/> Solid stainless steel disc for draw off (TSS-) (TPS- perforated) |
| <input type="checkbox"/> 2" (50 mm) tangent draw-off valve with perforated strainer (TVT-2) | <input type="checkbox"/> Double pantry faucet with swing spout (DF-18) | <input type="checkbox"/> Strainer hook (SH-) |
| <input type="checkbox"/> 3" (76 mm) tangent draw-off valve with perforated strainer (TVT-3) | <input type="checkbox"/> Single pantry kettle filler (SP-KF-GK) | <input type="checkbox"/> Pour strainer (TKS-G) |
| <input type="checkbox"/> Etched gallon markings (GM-) | <input type="checkbox"/> Double pantry kettle filler (DP-KF-GK) | <input type="checkbox"/> Pan carrier (PC-4) |
| | <input type="checkbox"/> Correctional package | <input type="checkbox"/> Draw-off valve hose kit (DVHK-) |
| | <input type="checkbox"/> Triple basket assembly (TBA-G) | |

STANDARD CONSTRUCTION SPECIFICATIONS

Shall be a Crown Model GLT-80 or GLT-100, self-contained, gas fired, steam jacketed kettle, ASME Code stamped, National Board Registered, AGA, CGA and NSF certified for operation up to 50 PSI.

A double wall interior shall form a steam jacket around the lower 2/3 of the kettle. The jacket enclosure shall contain factory sealed, distilled water.

The kettle interior shall be stainless steel, type 316 for high acid content cooking. Kettle exterior is fully insulated.

The bottom of the kettle shall be of hemispherical design for superior heat circulation.

The recessed control panel is located on the front right of the unit, in full view of the operator and easy to use.

Standard controls include direct immersion thermostat for operation at a

temperature range of 165°F to 275°F (74°C to 135°C) at 50 psi, water sight glass, cooking light, pressure gauge and electronic ignition with ignition indicator light, motor ON/OFF switch with indicator light and tilt switch.

Comes standard with 3 piece split faucet bracket.

Safety features include low water shut off with indicator light, pressure switch, pressure relief valve and a 100% safety gas shut off valve.

The kettle shall pivot on trunnions connected to the power tilt mechanism and control consoles.

The tilt mechanism shall allow the kettle to tilt past 90° for complete emptying.

The console shall be drip proof, stainless steel clad and shall be supported on all welded, 1-5/8" (41 mm) diameter stainless steel legs with flanged feet for securing to the floor.



Approval Notes: _____

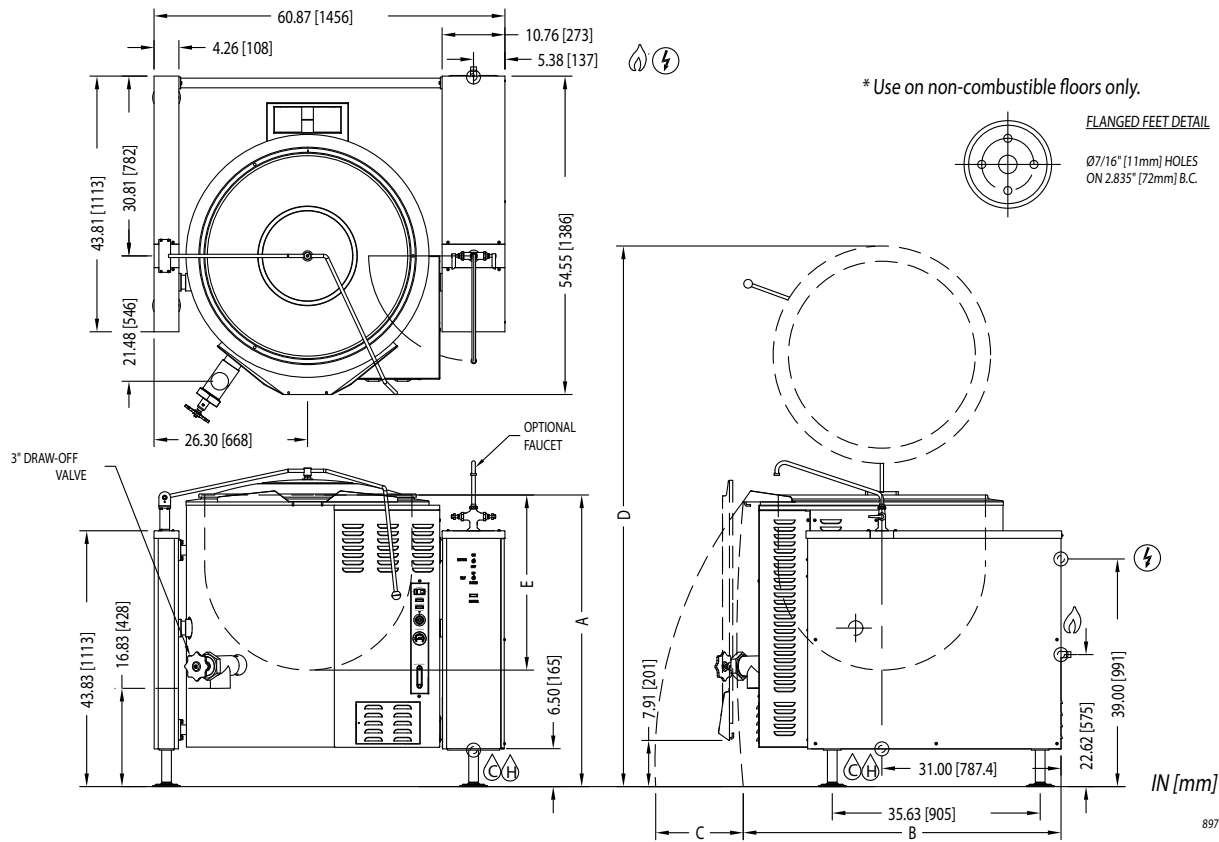

SERVICE CONNECTIONS

- GAS CONNECTION: Supply Gas through 3/4" pipe. A gas shut off valve must be installed in supply piping convenient and adjacent to appliance.
- ELECTRICAL CONNECTION : Unless otherwise specified, Field Wire Electrical Connection to be 120 volts, 60 Hz, 1 phase with grounding wire. Unit furnished with 8' cord and 3 prong plug. Total maximum amps 4.0.
- COLD WATER: 3/8" (10 mm) tubing to faucet
- HOT WATER: 3/8" (10 mm) tubing to faucet

DIMENSIONS

MODEL	CAPACITY	UNITS	A	B	C	D	E	SHIPPING WEIGHT	MINIMUM CLEARANCE	
									SIDES	BACK
GLT-80	80 gallons (302.8 liters)	in (mm)	45.18" (1147)	52.0" (1321)	22.0" (559)	89.63" (2277)	25.38" (645)	1253 lbs. [569 kg]	SIDES	0" [0 mm]
GLT-100	30 gallons (378.5 liters)	in (mm)	49.8" (1265)	54.5" (1383)	23.5" (597)	92.6" (2353)	30" (762)	1403 lbs. [637 kg]	BACK	4" [102 mm]

GAS CHARACTERISTICS

MODEL	GAS SUPPLY			
	BTU/HR.	kW/HR.	SUPPLY PIPE PRESSURE (W.C.)	
GLT-80/100	150,000	44.0	Natural 6"-14" (152-356 mm)	Propane 11"-14" (279-356 mm)

* For use on non-combustible floors only.

**INTENDED FOR COMMERCIAL USE ONLY.
NOT FOR HOUSEHOLD USE.**

