

DIRECT STEAM LEG-MOUNTED TWIN TILTING MIXER KETTLES

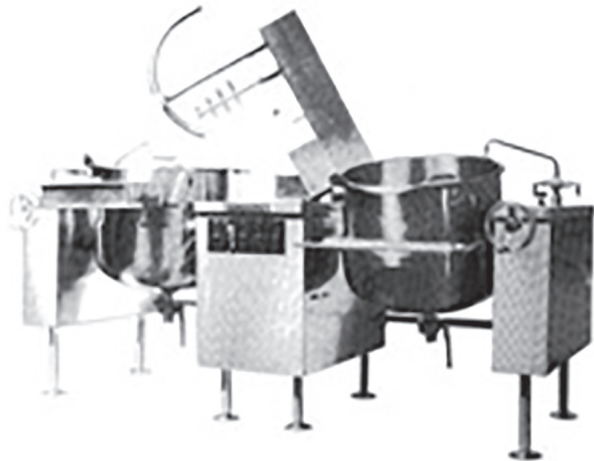

- DLTM-40-2
- DLTM-60-2
- DLTM-80-2
- DLTM-100-2

OPERATION SHALL BE BY:

Direct steam at a minimum of 5 PSI (34 kPa) and maximum of 30 PSI (207 kPa).

Hydraulic power supply is standard either:

- 208 Volts, 3 Phase, 60 Hz
- 240 Volts, 3 Phase, 60 Hz

OPTIONS & ACCESSORIES AT ADDITIONAL COST

- | | | |
|----------------------------------------------------------------|-------------------------------------------------------------|-------------------------------------------------------|
| <input type="checkbox"/> Swing faucet on left or right console | <input type="checkbox"/> Quick chill system (QCS-) | <input type="checkbox"/> Etched gallon markings (GM-) |
| <input type="checkbox"/> 2" manual butterfly valve (BV-2) | <input type="checkbox"/> Steam control assembly (STA-) | <input type="checkbox"/> Etched litre markings (LM-) |
| <input type="checkbox"/> 3" manual butterfly valve (BV-3) | <input type="checkbox"/> High pressure operation (HP-50) | <input type="checkbox"/> Pour lip strainer (TKS-) |
| <input type="checkbox"/> 480 VAC, 60 Hz, 3 Phase (for motor) | <input type="checkbox"/> Two piece lift off cover (MC-) | <input type="checkbox"/> Kettle heat shield (KHS-) |
| <input type="checkbox"/> Ball float trap (BFT-) | <input type="checkbox"/> Strainer for butterfly valve (MKS) | |

STANDARD CONSTRUCTION SPECIFICATIONS

Shall be a Crown model DLTM-40-2, DLTM-60-2, DLTM-80-2 or DLTM-100-2, direct steam, twin tilting kettle operating at a maximum of 30 psi.

Construction shall be welded stainless steel type 304 satin finish.

A double wall kettle interior shall form a steam jacket around the lower 2/3 of the kettle with 316 stainless steel liner for high acid content products.

The bottom of the kettle shall be of hemispheric design for maximum heat transfer.

The tubular legs shall be constructed of stainless steel pipe fitted with four hole, adjustable, flanged feet for securing to the floor.

A sealed stainless steel tilt mechanism shall permit the kettle to tilt forward a full 90° for complete emptying.

The tilt mechanism shall be self locking for positive stop action.

MIXER FEATURES:

The mixer is a variable speed unit powered by a 5 hp electric motor driving a hydraulic pump.

Two agitators shall be included, a primary stainless steel scraper/agitator, and a secondary high speed mixer.

Both agitators shall be removable for cleaning and no tools will be required for removal.

The console front to have the main power switch, mixer lift switch and variable speed control.

The bridge is constructed of 10 gauge stainless steel and contains two heavy duty hydraulic motors to drive the agitators.

The bridge shall be power tilt, and swing 140° out of the way for kettle tilting or cleaning.



Approval Notes: _____

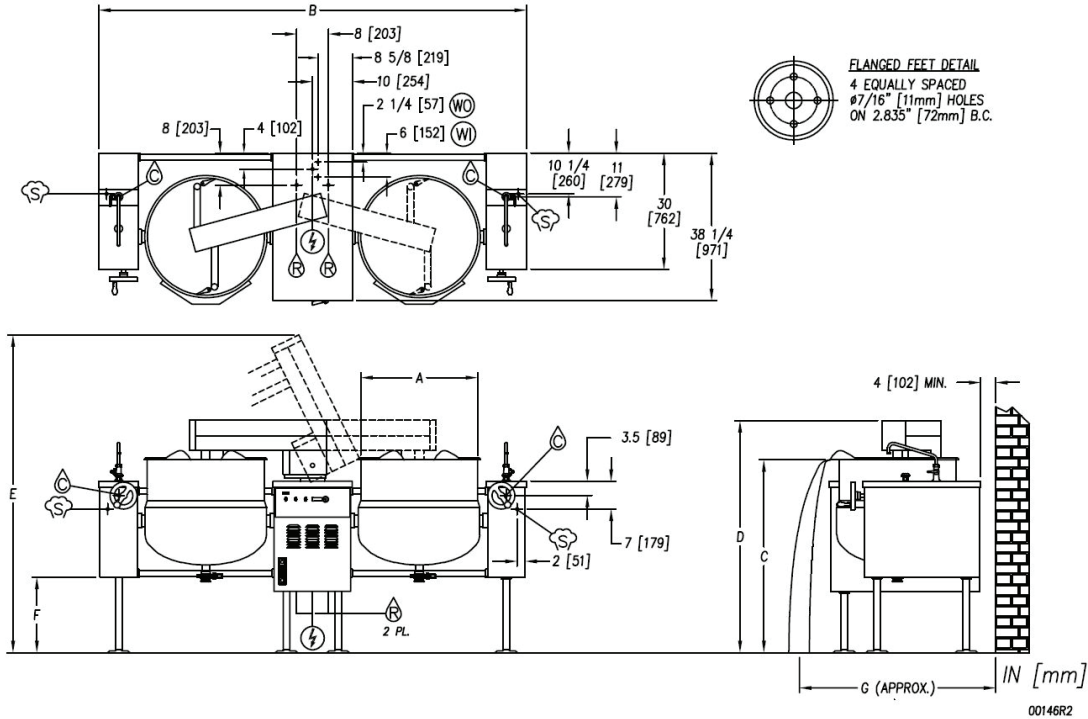

SERVICE CONNECTIONS

- ELECTRICAL CONNECTION: to be as specified on data plate.
- STEAM SUPPLY: 3/4" IPS. 5-30 PSI (34-207 kPa) optional 5-45 PSI (34-310 kPa).
- COLD and HOT WATER: 3/8" O.D. tubing to faucet. (OPTIONAL)
- CONDENSATE RETURN: 1/2" IPS.
- OIL COOLER WATER IN: 3/8" tube bulkhead union.
- OIL COOLER WATER OUT: 3/8" tube bulkhead union.

DIMENSIONS

MODEL	CAPACITY	UNITS	A	B	C	D	E	F	G
DLTM-40-2	40 Gal Each (151 liters)	inches (mm)	26" (660)	102" (2591)	43.25" (1099)	55" (1397)	75.63" (1921)	15.13" (384)	56" (1422)
DLTM-60-2	60 Gal Each (227 liters)	inches (mm)	29.5" (749)	108" (2743)	49" (1245)	58.5" (1486)	80" (2032)	19.5" (495)	58" (1473)
DLTM-80-2	80 Gal Each (303 liters)	inches (mm)	33" (838)	116" (2946)	49" (1245)	58.5" (1486)	80" (2032)	19.5" (495)	60" (1524)
DLTM-100-2	100 Gal Each (380 liters)	inches (mm)	35.5" (902)	121" (3073)	49" (1245)	58.5" (1486)	85" (2159)	19.5" (495)	63" (1600)

ELECTRICAL CHARACTERISTICS AND SPECIFICATIONS

MODEL	AMPS PER LINE		
	208V	240V	480V
DLTM-40-2	14.0	14.0	7.0
DLTM-60-2			
DLTM-80-2			
DLTM-100-2			
DLTM-100-2			

MODEL	SHIPPING WEIGHT	MINIMUM CLEARANCE	
DLTM-40-2	1360 lbs. [617 kg]	SIDES	0
DLTM-60-2	1440 lbs. [654 kg]		
DLTM-80-2	1490 lbs. [676 kg]	BACK	4" [102]
DLTM-100-2	1615 lbs. [735 kg]		

**INTENDED FOR COMMERCIAL USE ONLY.
NOT FOR HOUSEHOLD USE.**

