

Freezer Bases

CFB536: 36" Freezer Base
 CFB548: 48" Freezer Base
 CFB560: 60" Freezer Base
 CFB572: 72" Freezer Base



Designed in partnership with industry-leading Italian commercial manufacturer, Desmon.



CFB536



CFB548



CFB560



CFB572

Project:

Notes:

Features and Specifications

Stainless steel
CFB536 capacity: 2 drawers hold (2) 12"x20"x4" pans
CFB548 capacity: 2 drawers hold (4) 12"x20"x4" pans
CFB560 capacity: 2 drawers hold (4) 12"x20"x4" pans
CFB572 capacity: 4 drawers hold (8) 12"x20"x4" pans
Electronic digital temperature control with alarms
Autodefrost
Epoxy coated, sealed evaporator eliminates potential corrosion
High efficiency evaporator coil & condenser
Factory pre-wired for dedicated outlet
CFB536 dimensions: 26" H x 36" W x 32 1/2" D
CFB548 dimensions: 26" H x 48" W x 32 1/2" D
CFB560 dimensions: 26" H x 60" W x 32 1/2" D
CFB572 dimensions: 26" H x 72" W x 32 1/2" D
Temperature range: 14°F - (-13°F)
High efficiency compressor with 7.3 running amps
Environmentally friendly R452A refrigerant

Model Details

Model	Description	Voltage/Hz	Shipping Weight
UCFB536-SS61A	36" Freezer Base	115v / 60hz	340 lb
UCFB548-SS61A	48" Freezer Base	115v / 60hz	410 lb
UCFB560-SS61A	60" Freezer Base	115v / 60hz	549 lb
UCFB572-SS61A	72" Freezer Base	115v / 60hz	653 lb



Product Specifications • Freezer Bases

Front (CFB536)

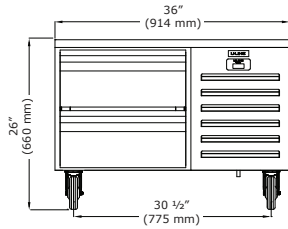

Side

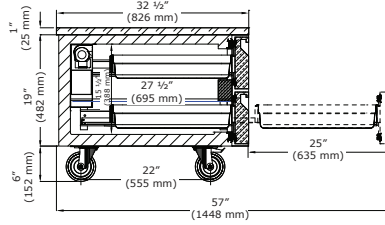

Top

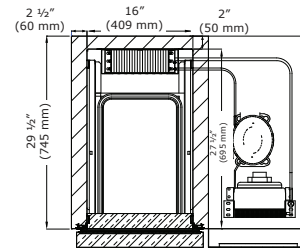

Front (CFB548)

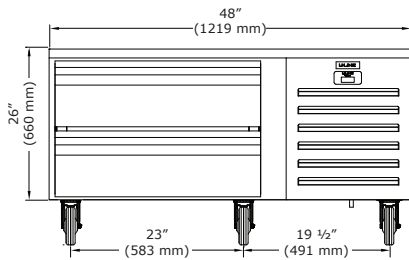

Side

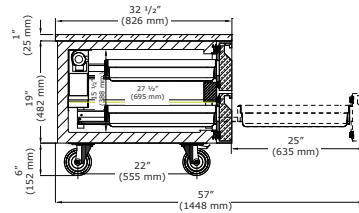

Top

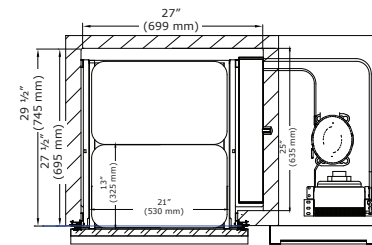

Front (CFB560)

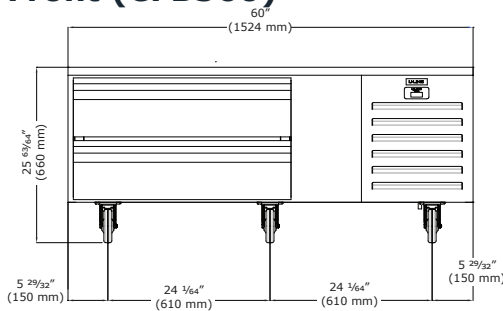

Side

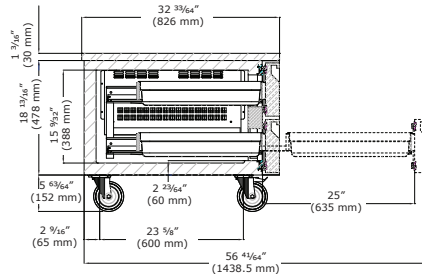

Top

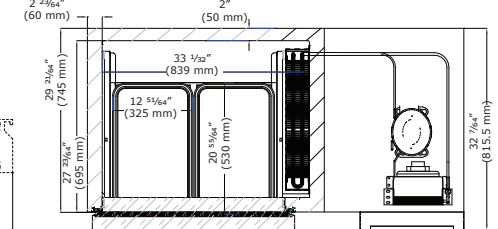

Front (CFB572)

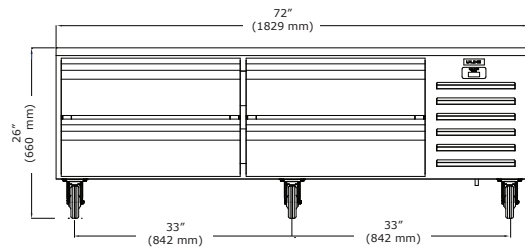

Side

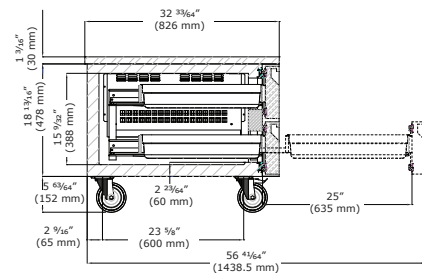

Top

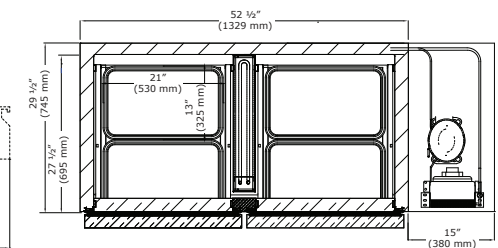

Commercial Warranty

1 Year (parts & labor) / 5 year sealed system (parts)
See complete warranty for details

