



## 1977-'82 G-Body Rack & Pinion Kit Instructions

8012400-01

UniSteer offers a 2-year, unlimited mile warranty against all manufacturer defects of their kits and supplied parts. UniSteer will not honor any warranty on any parts that have been modified or improperly installed. Full refund will NOT be granted to any kits that are damaged, scratched, or altered in any fashion. UniSteer will not reimburse any labor money to the customer to change out the part even under a warranty repair.



**\*USE ONLY POWER STEERING FLUID IN SYSTEM. DO NOT USE ATF.**

**\*ALTHOUGH THIS KIT IS FAIRLY SIMPLE TO INSTALL, SOME MODIFICATIONS ARE NECESSARY.**

**\*BEFORE STARTING INSTALLATION, PLEASE BE AWARE OF THE MODIFICATIONS THAT ARE NEEDED TO INSTALL.**

**\*BE AWARE OF THE SPECIFIC APPLICATIONS THAT THIS KIT WILL FIT AS OUTLINED IN SECTION #1.**

**\*THE FACTORY OIL PLUG IS BLOCKED ON BIG BLOCK MOTORS. THE RACK WILL HAVE TO BE UNBOLTED TO CHANGE THE OIL OR A NEW OIL PLUG WILL HAVE TO BE INSTALLED IN THE PAN.**

**\*DUE TO VARIABLES OUTSIDE OUR CONTROL THESE KITS MAY NOT FIT ALL APPLICATIONS. ALSO, PLEASE VERIFY KIT WILL FIT YOUR APPLICATION BEFORE ALTERING VEHICLE.**

# KIT CONTENTS:

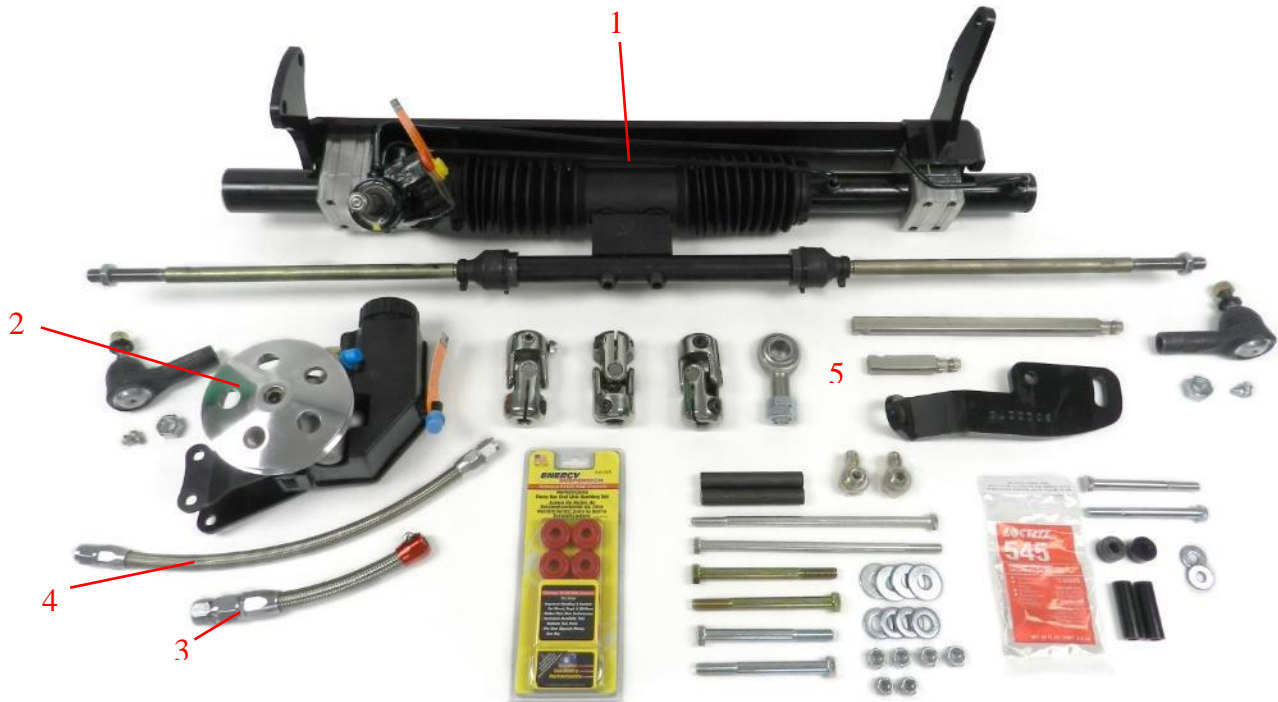

#	Part Number	Description	Qty	Inspected By
1	<b>8012410-01</b>	<b>Rack &amp; Pinion</b>	1	
	--8020940	- Outer Ends	2	
	--114040	- Inner Ends	2	
	--623240	- Rack Install Kit	1	
	----120410	--- 7/16"-14 Lock Nut	4	
	----120490	--- 3/8"-16 Lock Nut	2	
	----200860	--- 7/16" Flat Washer	4	
	----200880	--- 1/2" Flat Washer	4	
	----208080	--- Sway Bar Link Bushing	1	
	----231430	--- 7/16"-14 x 5" Hex Bolt	2	
	----231530	--- 7/16"-14 x 4 1/2" Hex Bolt	2	
	----233870	--- 3/8"-16 x 9" Hex Bolt	2	
	----244450	--- Stabilizer Link Tube	2	
	----621710	--- 16mm & 18mm Banjo Fittings	1	
2	<b>8061360</b>	<b>Pump Kit</b>	1	
	--8060470	- C-5 Pump	1	
	--8020630	- V-Belt Pulley	1	
	--8022450	- Pump Mounting Bracket	1	
	--8022440	- Pump Stabilizer Bracket	1	
	--623250	- Pump Install Kit	1	
	----200850	--- 5/16" Flat Washer	2	
	----205810	--- Support Stand Off	2	
	----206190	--- 5/8" Stand Off	2	
	----231280	--- 3/8"-16 x 3 1/2" Hex Bolt	2	
3	<b>8028160</b>	<b>12" #8 Hose</b>	1	
4	<b>8028170</b>	<b>15.125" #6 Hose</b>	1	
5	<b>8053040</b>	<b>Shaft Kit</b>	1	
	--8050240	- U-Joint 3/4"-36 c 3/4"-DD (Pinion)	1	
	--8050250	- U-Joint 9/16"-30 x 3/4"-DD (Middle)	1	
	--8050760	- Shaft Support w/ Nut	1	
	--8051280	- U-Joint 1"-DD x 9/16"-30 (Column)	1	
	--8022270	- Shaft Support Bracket	1	
	--5412230	- 3.611" DD Shaft	1	
	--5412220	- 10.875" DD Shaft	1	

## Disassembly

The easiest way to install this kit is to have the car on a lift or at least on jack stands. There is no need to have the front wheels off of the ground. In fact, if you do not lift the wheels off of the ground the alignment should not be affected by the installation.

**Take a minute to familiarize yourself with the stock steering components of your car:**

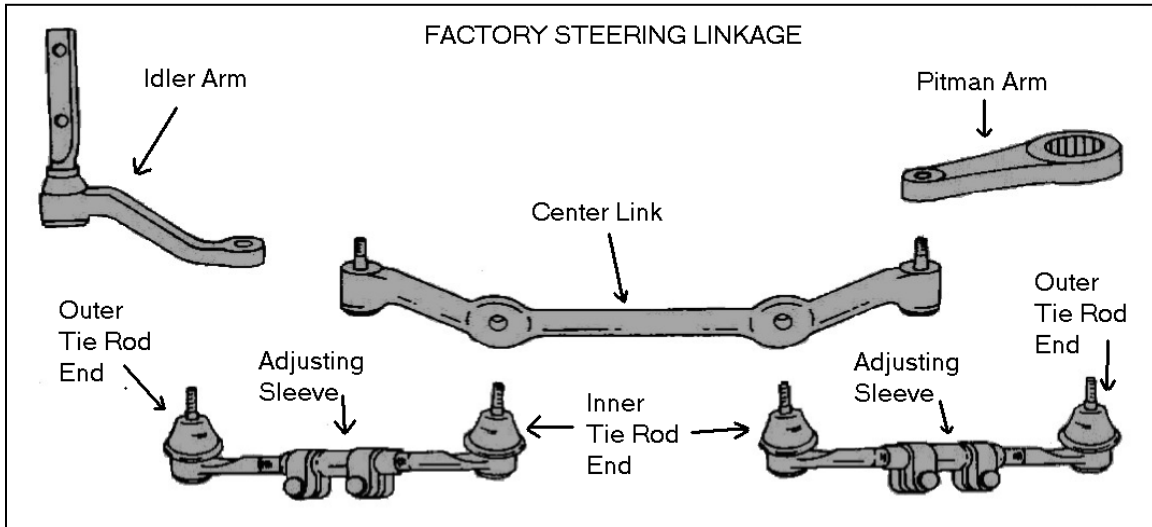

1. Remove the Nut holding the outer tie rod end. Remove both nuts on each tie rod end.



2. Remove the nut holding the pitman arm to the center link.



3. Unbolt the idler arm from the passenger side of the vehicle. The whole steering linkage should be removed from the car.

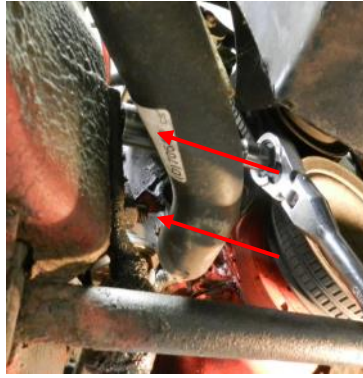

4. Remove the sway bar stabilizers.



5. To remove the Gear Box, disconnect the hose clamps and remove the hose lines out of the way. The second line, remove with a wrench.

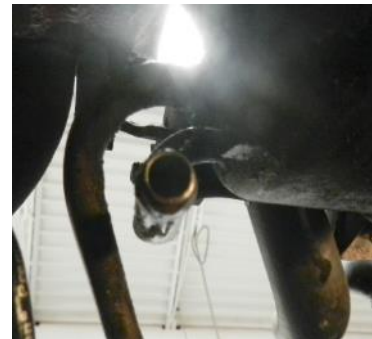
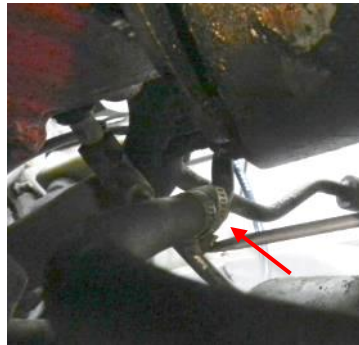

6. Remove the pinch bolt that connects the steering shaft to the gear box. Once loosened slide the steering shaft towards the steering wheel.



7. Remove the bolts holding the gear box in location. They are located on the frame wall. Once bolts are removed the Gear box will be able to be removed from the vehicle.



8. Remove the steering shaft by removing the bolt at the top of the steering shaft. Tap lightly to slide off the original shaft.



9. Remove the Hydraulic pump from the block. There are 2 bolts, one next to the header and one in the front of the block.

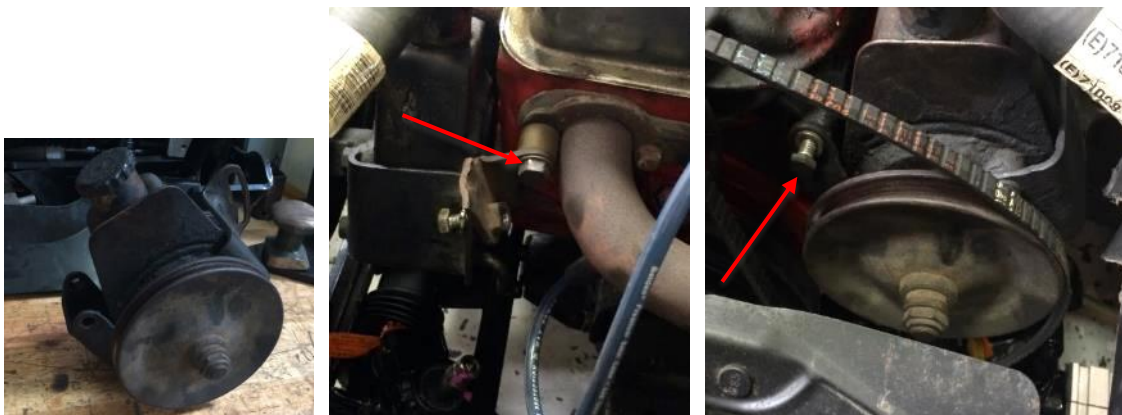

10. To remove the power steering belt, the alternator belt has to be removed. Loosen the bolt that holds the alternator belt tension. Once loose, remove both belts.

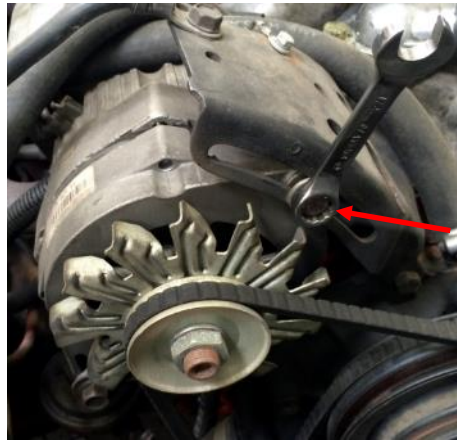

## Installation

1. The rack and Pinion are installed into the location of the gearbox and the idler arm. Slide bracket into location and apply bolts. On the passenger side, slide the bolts through the frame rail.



2. Install the shaft support bracket. Use the same location as the rack and pinion on the gearbox bolt holes.



3. Install the U-Joint to the pinion off the rack (#)



4. Install the shorter shaft into the U-Joint.



5. Install the U-Joint onto the steering column shaft. Tighten the set screw and nut flush with each other.



6. Install the longer steering shaft into the U-Joint.

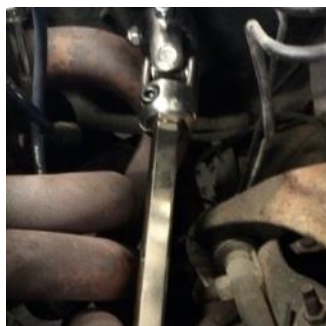

7. Slide the last U-Joint onto the steering shaft, ensure the steering wheel is straight and connect the U-Joint to the shaft coming from the pinion.



8. Put the spacers in location on the water pump, between the brackets and on the backside with the bolts holding them. Bolt the pump onto the car.

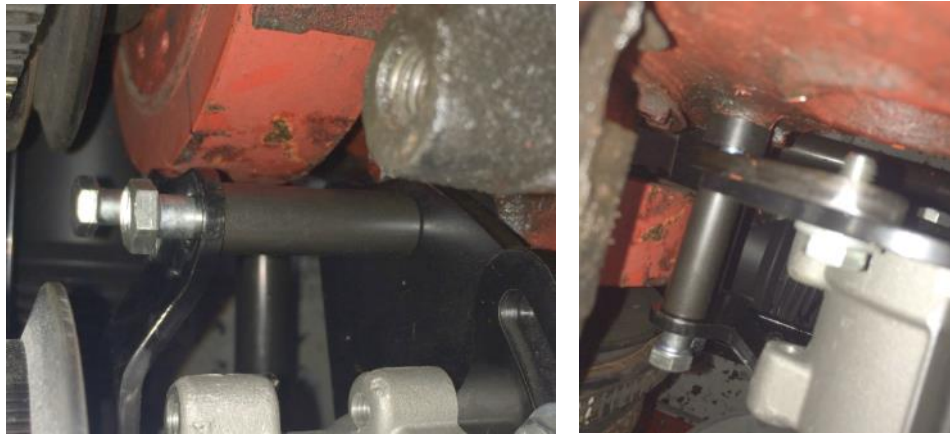

9. Install the belt for the pump and tighten up the bolts and the tensioner bolt with the belt tight.





10. Install the fittings onto the ports on the housing. Preassemble the fittings with the provided lock tight. At a 2 O'clock setting.

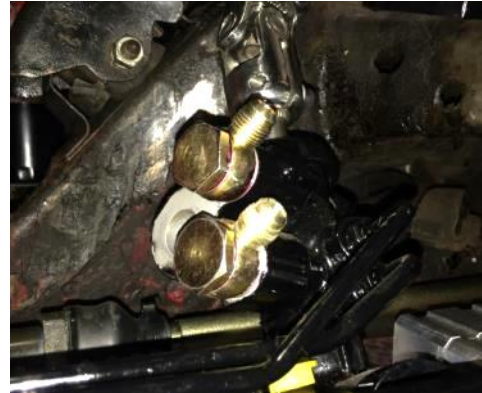

11. Install the hoses onto the pump and the rack. Thread the longer hose onto the port out the top of the pump. Hose clamp the shorter line to the reservoir.



12. Connect the hoses to the rack and pinion ports. The high-pressure port is marked on the rack. Ensure the hoses are not connected to the wrong ports.



13. Reinstall the stabilizers with the provided ones.
14. Install the tie rod ends. Ensure the rack is centered and the steering wheel is centered.

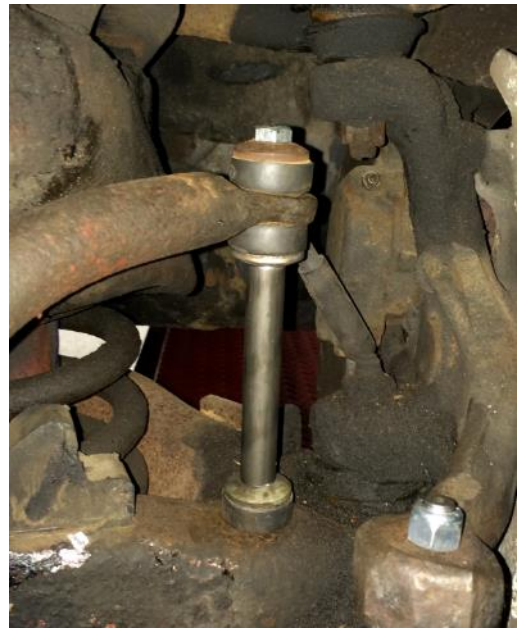

## Notes

To Mis-Phase U-Joints, line up the grooves of the U-Joints (red), 45 degrees opposite of each other



Lower U-Joint  
Fits the DD end of shaft

Upper U-Joint  
Fits the Spline end of shaft

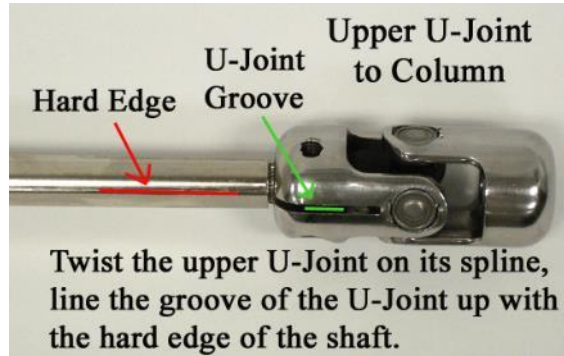
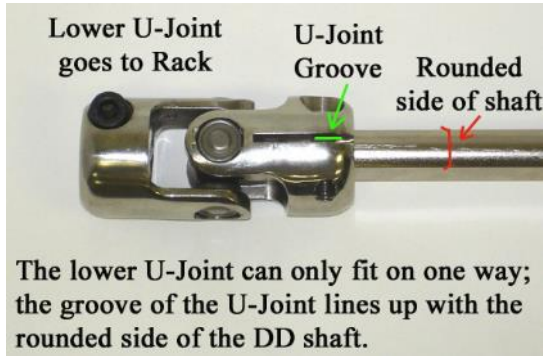

To Mis-Phase the U-Joints, the Groove of the upper U-Joint must be aligned or rotated 45° away from the Groove of the lower U-joint as shown in the illustration below.

**DO NOT REVERSE THE LINES! THIS WILL BLOW THE SEALS OUT OF THE RACK AND VOID YOUR WARRANTY.**

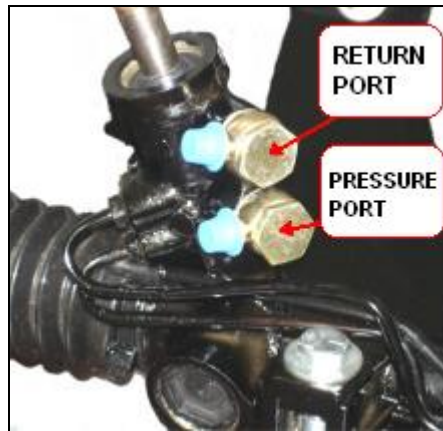

If you have any questions or problems regarding this product, please contact:

**UNISTEER** *Performance Products*

**1555 Enterprise Parkway**

**Twinsburg OH 44087**

**800-338-9080**

**WWW.UNISTEER.COM**

Copyright © by MAVAL Manufacturing Corporation All rights reserved.

No part of these materials can be reproduced or utilized in any form or by any means, electronic or mechanical, including photocopying, recording or by any information storage and retrieval system, with permission in writing from MAVAL Manufacturing Corporation.