



Driver LC 75W 900–1800mA 0-10V NFC AUX Ip EXC2 UNV

Linear excite NFC series

Product description

- Constant current LED driver
- Dimmable via 0 ... 10 V interface (incl. stand-by)
- Dimming range 1 – 100 % (incl. stand-by)
- UL8750 with class 2 output based on UL1310
- UL Listed Class P
- FCC Part 15, Class A
- Adjustable output current between 900 and 1,800 mA with NFC
- Max. output power 75 W
- Up to 88.9 % efficiency
- Meets Strictest Flicker Free Performance Standards
- Nominal lifetime up to 100,000 h
- 5 years guarantee (conditions at www.tridonic.com)

Housing properties

- Casing: metal, white
- Type of protection IP20
- Dry and damp location

Functions

- Adjustable output current in 1-mA-steps (NFC)
- 24 V AUX output
- Fade-off time programmable
- Protective features (overtemperature, short-circuit, overload, no-load, input voltage range)

Benefits

- Operating windows for maximum compatibility
- Added energy savings with dimming via 0 ... 10 V interface
- Configurable via NFC
- Meets California Title 24
- Tailor your dimming response with either Linear, Logarithmic or Square Dimming Curves

Typical applications

- For linear/area lighting in office, education, healthcare, and general lighting applications

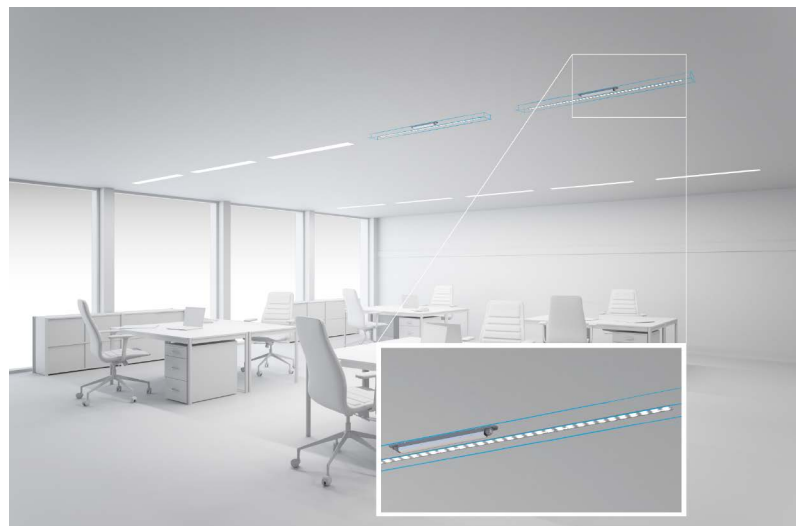
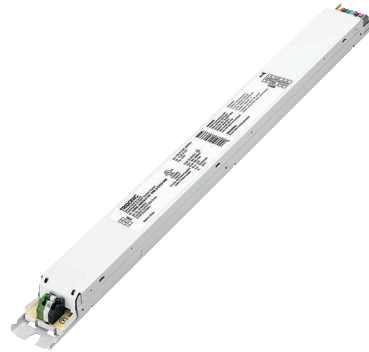

Standards, page 4

Driver LC 75W 900–1800mA 0-10V NFC AUX Ip EXC2 UNV

Linear excite NFC series

Technical data

Rated supply voltage	120 – 277 V
AC voltage range	108 – 305 V
Mains frequency	50 / 60 Hz
Typ. current (at 120 V, 60 Hz, full load) ^{① ②}	726 mA
Typ. current (at 277 V, 60 Hz, full load) ^{① ②}	314 mA
Leakage current (at 120 V, 60 Hz, full load) ^{③ ④}	< 750 µA
Leakage current (at 277 V, 60 Hz, full load) ^{③ ④}	< 750 µA
Max. input power (at 120 V, 60 Hz, full load)	873 W
Max. input power (at 277 V, 60 Hz, full load)	85.0 W
Typ. efficiency (at 120 V, 60 Hz, full load) ^⑤	86.8 %
Typ. efficiency (at 277 V, 60 Hz, full load) ^⑤	88.9 %
λ (at 120 V, 60 Hz, full load) ^⑥	0.99
λ (at 277 V, 60 Hz, full load) ^⑥	0.98
Typ. power consumption on stand-by (at 120 V, 60 Hz) ^⑦	< 0.5 W
Typ. power consumption on stand-by (at 277 V, 60 Hz) ^⑦	< 0.5 W
Typ. input current in no-load operation (at 120 V, 60 Hz)	14 mA
Typ. input current in no-load operation (at 277 V, 60 Hz)	27 mA
Typ. input power in no-load operation (at 120 V, 60 Hz)	0.5 W
Typ. input power in no-load operation (at 277 V, 60 Hz)	0.9 W
In-rush current (peak / duration at 120 V)	5 A / 25 µs
In-rush current (peak / duration at 277 V)	13.9 A / 18 µs
THD (at 120 V, 60 Hz, full load) ^⑧	< 10 %
THD (at 277 V, 60 Hz, full load) ^⑧	< 20 %
Starting time (at 120 V, full load) ^⑨	≤ 500 ms
Starting time (at 277 V, full load) ^⑨	≤ 500 ms
Turn off time (full load)	< 30 ms
Hold time (power failure, full load)	< 20 ms
Output current tolerance ^{⑩ ⑪}	± 5 %
Max. output current peak (non-repetitive)	≤ output current + 5 %
Output LF current ripple (< 120 Hz)	± 5 %
Output P _{st} L ^M (at full load)	≤ 1
Output SVM (at full load)	≤ 0.4
Max. output voltage	60 V
Dimming range	1 – 100 %
Mains surge capability (between L - N)	2 kV
Mains surge capability (between L/N - PE)	2.5 kV
Surge voltage at output side (against PE)	500 V
Type of protection	IP20
Lifetime	up to 100,000 h
Guarantee (conditions at www.tridonic.com)	5 years
Dimensions L x W x H	16.73 x 1.18 x 0.83 inch

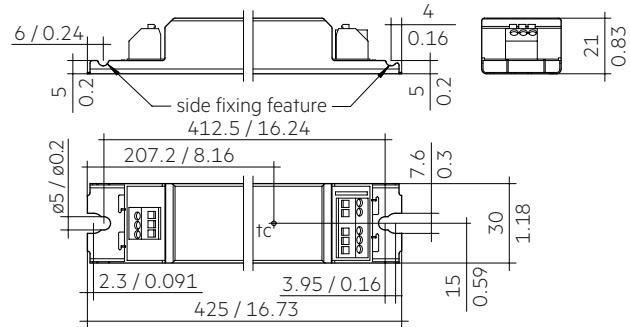

Dimensions in mm / inch

Ordering data

Type	Article number	Packaging carton	Packaging low volume	Packaging high volume	Weight per pc.
LC 75/900-1800/54 0-10V NAX Ip EXC2 UNV	87500850	10 pc(s).	130 pc(s).	910 pc(s).	0.8 lbs

Specific technical data

Type	Output current ^④	Min. forward voltage	Max. forward voltage	Max. output power (at 120 V, 60 Hz, full load)	Typ. power consumption (at 120 V, 60 Hz, full load)	Typ. current consumption (at 120 V, 60 Hz, full load)	Max. output power (at 277 V, 60 Hz, full load)	Typ. power consumption (at 277 V, 60 Hz, full load)	Typ. current consumption (at 277 V, 60 Hz, full load)	tc temperature ^⑥	Ambient temperature ta max.
LC 75/900-1800/54 0-10V NAX Ip EXC2 UNV	900 mA	20 V	54.0 V	48.6 W	84.2 W	447 mA	48.6 W	53.6 W	207 mA	149 °F	-13 ... +131 °F
	1,000 mA	20 V	54.0 V	54.0 W	60.1 W	497 mA	54.0 W	60.1 W	228 mA	158 °F	-13 ... +131 °F
	1,100 mA	20 V	54.0 V	59.4 W	66.6 W	555 mA	59.4 W	65.4 W	251 mA	158 °F	-13 ... +131 °F
	1,200 mA	20 V	54.0 V	64.8 W	72.9 W	608 mA	64.8 W	71.7 W	278 mA	158 °F	-13 ... +131 °F
	1,300 mA	20 V	54.0 V	70.2 W	80.8 W	676 mA	70.2 W	78.6 W	294 mA	167 °F	-13 ... +131 °F
	1,400 mA	20 V	53.6 V	75.0 W	87.2 W	732 mA	75.0 W	84.9 W	318 mA	167 °F	-13 ... +131 °F
	1,500 mA	20 V	50.0 V	75.0 W	85.9 W	728 mA	75.0 W	82.8 W	311 mA	167 °F	-13 ... +131 °F
	1,600 mA	20 V	46.9 V	75.0 W	86.7 W	736 mA	75.0 W	84.5 W	313 mA	176 °F	-13 ... +131 °F
	1,700 mA	20 V	44.0 V	74.8 W	87.5 W	745 mA	74.8 W	84.4 W	314 mA	176 °F	-13 ... +131 °F
	1,800 mA	20 V	41.7 V	75.0 W	86.9 W	738 mA	75.0 W	85.1 W	317 mA	176 °F	-13 ... +131 °F

① Valid at 100 % dimming level.

② Depending on the selected output current.

③ No-load on AUX power supply.

④ The table only lists a number of possible operating points but does not cover each single point. The output current can be set within the total value range in 1-mA-steps.

⑤ Output current is mean value.

⑥ 5 years guarantee.

1. Standards

UL 8750
CSA C22.2
FCC Part 15, Class A

Product not designed for European Economic Area.

This device complies with Part 15 of the FCC Rules. Operation is subject to the following two conditions:

- (1) this device may not cause harmful interference, and
- (2) this device must accept any interference received, including interference that may cause undesired operation.

2. Thermal details and lifetime

2.1 Expected lifetime

Expected lifetime 120 V

Type	Output current	ta	45 °C / 113 °F	50 °C / 122 °F	55 °C / 131 °F
	900 mA	tc	55 °C / 131 °F	60 °C / 140 °F	65 °C / 149 °F
		Lifetime	> 100,000 h	> 100,000 h	> 100,000 h
LC 75/900-1800/54 0-10V NAX Ip EXC2 UNV	>900 – 1,200 mA	tc	60 °C / 140 °F	65 °C / 149 °F	70 °C / 158 °F
		Lifetime	> 100,000 h	> 100,000 h	95,000 h
	>1,200 – 1,500 mA	tc	65 °C / 149 °F	70 °C / 158 °F	75 °C / 167 °F
		Lifetime	> 100,000 h	95,000 h	70,000 h
	>1,500 – 1,800 mA	tc	70 °C / 158 °F	75 °C / 167 °F	80 °C / 176 °F
		Lifetime	95,000 h	70,000 h	50,000 h

Expected lifetime 277 V

Type	Output current	ta	45 °C / 113 °F	50 °C / 122 °F	55 °C / 131 °F
	900 mA	tc	55 °C / 131 °F	60 °C / 140 °F	65 °C / 149 °F
		Lifetime	> 100,000 h	> 100,000 h	> 100,000 h
LC 75/900-1800/54 0-10V NAX Ip EXC2 UNV	>900 – 1,200 mA	tc	60 °C / 140 °F	65 °C / 149 °F	70 °C / 158 °F
		Lifetime	> 100,000 h	> 100,000 h	95,000 h
	>1,200 – 1,500 mA	tc	65 °C / 149 °F	70 °C / 158 °F	75 °C / 167 °F
		Lifetime	> 100,000 h	95,000 h	70,000 h
	>1,500 – 1,800 mA	tc	70 °C / 158 °F	75 °C / 167 °F	80 °C / 176 °F
		Lifetime	95,000 h	70,000 h	50,000 h

The LED driver is designed for a lifetime stated above under reference conditions and with a failure probability of less than 10 %.

3. Installation / wiring

3.1 Circuit diagram

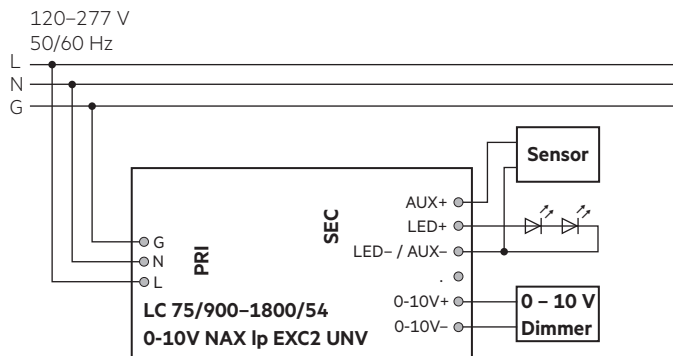

Class 2 Circuit, Suitable for Class 1 or Class 2 wiring only.

3.2 Wiring type and cross section

For wiring use stranded wire with ferrules or solid wire from 0.2 – 1.5 mm² (AWG24 – 16). Strip 8.5–9.5 mm (3/8 inch) of insulation from the cables to ensure perfect operation of the push-wire terminals. Use one wire for each terminal connector only.

LED module/LED driver/supply

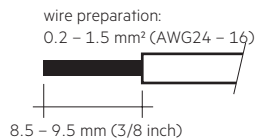

3.3 Loose wiring

Press down the “push button” and remove the cable from front.

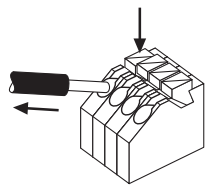

3.4 Wiring guidelines

- Run the secondary lines separately from the mains connections and lines to achieve good EMC performance.
- The max. secondary cable length (AUX, LED) is 2 m / 6.56 feet (4 m / 13.12 feet circuit).
- For good EMC performance, keep the LED wiring as short as possible.
- Secondary switching is not permitted.
- The LED driver has no inverse-polarity protection on the secondary side. Wrong polarity can damage LED modules with no inverse-polarity protection.
- Wrong wiring of the LED driver can lead to malfunction or irreparable damage.
- To avoid the damage of the Driver, the wiring must be protected against short circuits to earth (sharp edged metal parts, metal cable clips, louver, etc.).

3.5 Hot plug-in

Hot plug-in is not supported due to residual output voltage of > 0 V.

This can damage the LED load.

When connecting an LED load, restart the device to activate the LED output.

This can be done via mains reset.

When used in conjunction with a self-contained emergency LED driver the emergency device must break the mains supply to the driver during the test mode/emergency mode (delayed mains supply of the LED driver at mains return) to prevent hot plug-in of the LED load.

3.6 Earth connection

The earth connection is conducted as protection earth (PE). If the LED Driver will be earthed, protection earth (PE) has to be used. There is no earth connection required for the functionality of the LED driver.

Earth connection is recommended to improve following behaviour:

- Electromagnetic interferences (EMI)
- Transmission of mains transients to the LED output

In general it is recommended to earth the LED driver if the LED module is mounted on earthed luminaire parts respectively heat sinks and thereby representing a high capacity against earth.

4. Electrical values

4.1 Operating window

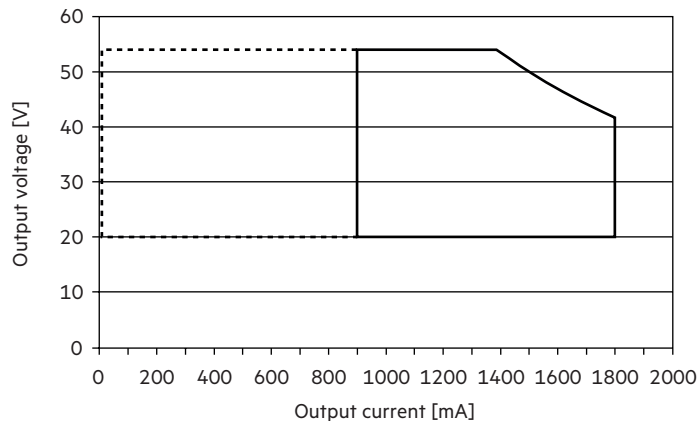

— Operating window 100 %
 - - - Operating window dimmed

Make sure that the LED driver is operated within the given window under all operating conditions. Special attention needs to be paid at dimming as the forward voltage of the connected LED modules varies with the dimming level, due to the implemented amplitude dimming technology. Coming below the specified minimum output voltage of the LED driver may cause the device to shut-down.

4.2 Efficiency vs load

120 V, 60 Hz:

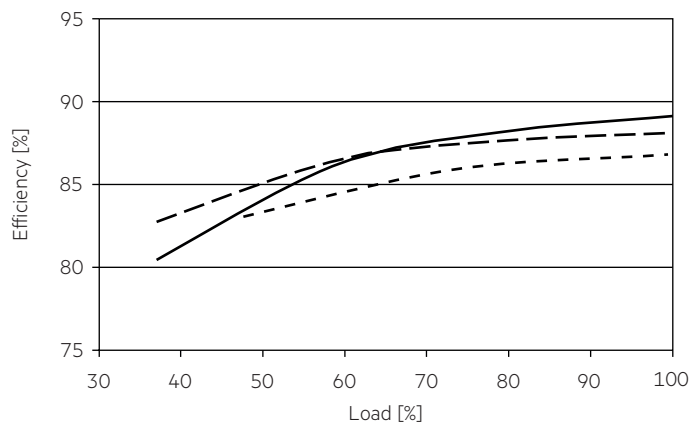

277 V, 60 Hz:

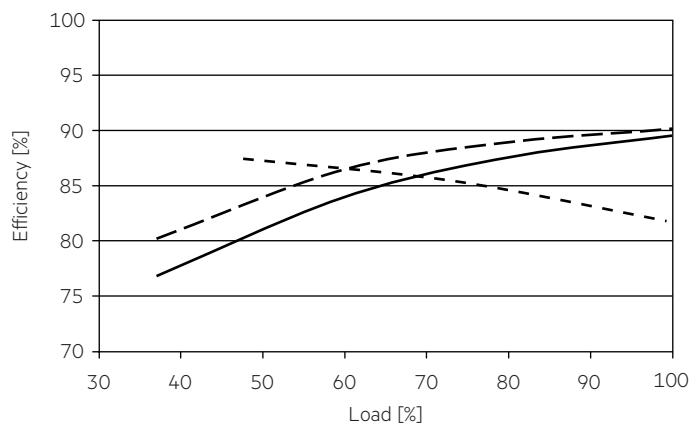

No-load on AUX power supply.

4.3 Power factor vs load

120 V, 60 Hz:

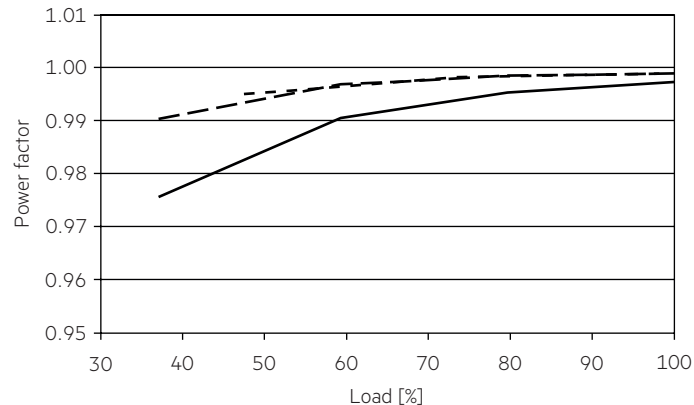

277 V, 60 Hz:

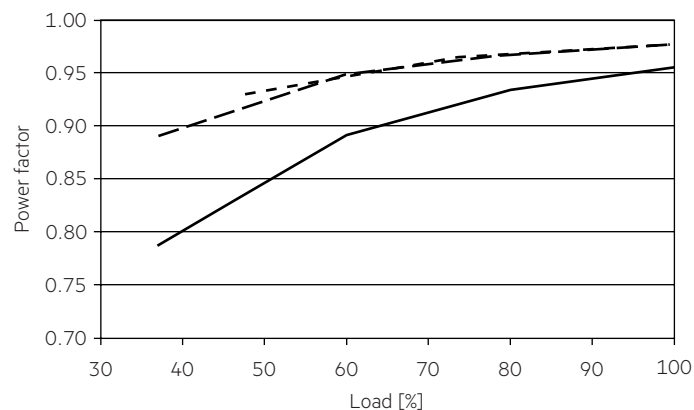

4.4 THD vs load (without harmonic < 5 mA or 0.6 % of the input current)

120 V, 60 Hz:

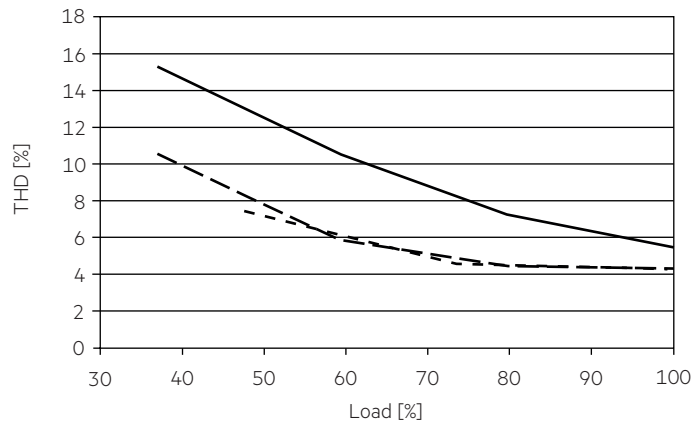

277 V, 60 Hz:

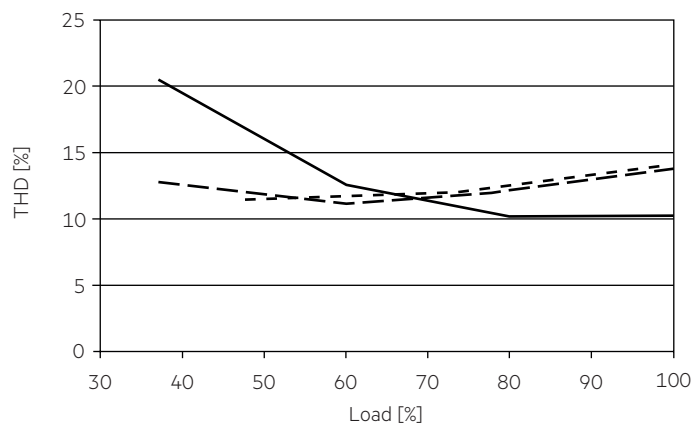

— 900 mA
 - - - 1400 mA
 - · - · 1800 mA

100 % load corresponds to the max. output power (full load) according to the table on page 3.

4.5 Maximum loading of automatic circuit breakers in relation to inrush current

120 V, 60 Hz:

Automatic circuit breaker type	C10	C13	C16	C20	B10	B13	B16	B20	Inrush current
Installation Ø	1.5 mm ² / AWG16	1.5 mm ² / AWG16	2.5 mm ² / AWG14	2.5 mm ² / AWG14	1.5 mm ² / AWG16	1.5 mm ² / AWG16	2.5 mm ² / AWG14	2.5 mm ² / AWG14	I_{max} time
LC 75/900-1800/54 0-10V NAX Ip EXC2 UNV	no limitation in relation to inrush current								5 A 25 µs

277 V, 60 Hz:

Automatic circuit breaker type	C10	C13	C16	C20	B10	B13	B16	B20	Inrush current
Installation Ø	1.5 mm ² / AWG16	1.5 mm ² / AWG16	2.5 mm ² / AWG14	2.5 mm ² / AWG14	1.5 mm ² / AWG16	1.5 mm ² / AWG16	2.5 mm ² / AWG14	2.5 mm ² / AWG14	I_{max} time
LC 75/900-1800/54 0-10V NAX Ip EXC2 UNV	no limitation in relation to inrush current								13.9 A 18 µs

These are max. values calculated out of continuous current running the device on full load.
There is no limitation due to inrush current.
If load is smaller than full load for calculation only continuous current has to be considered.

4.6 Dimming

Dimming range is 1 to 100%.
The operating window shows the minimum reachable power in dimmed state.

4.7 Dimming characteristics

Control input (0 – 10 V)

Control input open	max. dimming level
Interface current range	120 µA ± 3 %
Max. permitted input voltage	± 16 V
Voltage range dimming	0 – 10 V [Ⓢ]
Input voltage = 0 V	stand-by
Input voltage < 1 V	min. dimming level [Ⓢ]
Input voltage > 10 V	max. dimming level [Ⓢ]

Interface supports current source / sink dimmers. Interface is Class 2.
0 – 10 V interface shall ONLY be wired as Class 1 or Class 2 Circuit.

 More than one Power Supply is present in accordance to NEC and UL8750, section SF8.3.

[Ⓢ] See graph below (at full load):

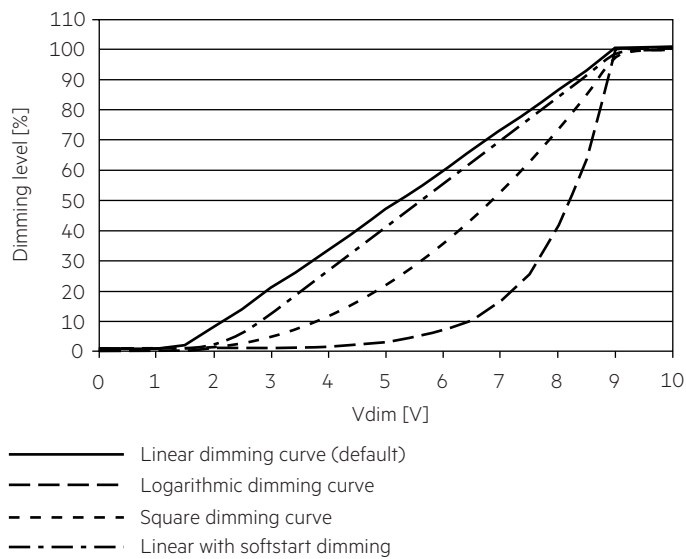

Dimming profiles programmable via NFC.

4.8 Insulation between terminals

Insulation	Mains	AUX	-LED / +LED	0-10V
Mains	-	double	double	double
AUX	double	-	-	basic
-LED / +LED	double	-	-	basic
0-10V	double	basic	basic	-

basic ... represents basic insulation.

double ... represents double or reinforced insulation.

5. Software / Programming / Interfaces

5.1 Software / programming

With appropriate software and interface different functions can be activated and various parameters can be configured in the LED driver. The Driver supports the following software and interfaces:

Software / hardware for configuration:

- companionSUITE (deviceGENERATOR, deviceCONFIGURATOR, deviceANALYSER)

Interfaces for data transfer:

- NFC

5.2 Nearfield communication (NFC)

The NFC Interface allows wireless communication with the LED driver. This interface offers the option to write configuration and to read configuration, errors and events with the companionSUITE. A correct communication between the LED driver and the NFC antenna can only be guaranteed if the Driver is directly placed on the antenna. Any material placed between the LED driver and the NFC antenna can cause a deterioration of the communication quality. We recommend the use of following NFC antennas: www.tridonic.com/nfc-readers







NFC is compliant with ISO/IEC 15693 standard.

6. Functions

☉ companionSUITE:

NFC

The companionSUITE with deviceGENERATOR, deviceCONFIGURATOR and deviceANALYSER is available via our WEB page: <https://www.tridonic.com/com/en/products/companionsuite.asp>

Icon	Function	NFC
	OEM Identification	☉
	OEM GTIN	☉
	LED current	☉
	Dimming curve (0-10V)	☉
	Minimum level (0-10V)	☉
	Fade-off time (0-10V)	☉

6.1 LED current



The LED output current must be adapted to the connected LED module. The value is limited by the current range of the respective device.

6.2 Integrated auxiliary power supply (AUX)



Auxiliary power supply to connect external sensor.
For wiring see circuit diagram.
Output voltage: 16 – 25 V
Output current: 50 mA max.
AUX port is active in stand-by mode.

7. Protective features

7.1 Short-circuit behaviour

In case of a short-circuit at the LED output the LED output is switched off. After restart of the LED driver the output will be activated again. The restart can be done via mains reset.

7.2 No-load operation

The LED driver will not be damaged in no-load operation. The output will be deactivated and is therefore free of voltage. If a LED load is connected the device has to be restarted before the output will be activated again.

7.3 Overload protection

If the maximum load is exceeded by a defined internal limit, the LED driver turns off the LED output. After restart of the LED driver the output will be activated again. The restart can be done via mains reset.

7.4 Overtemperature protection

The LED driver is protected against temporary thermal overheating. Thermal overload protection is triggered if the maximum T_c temperature is exceeded by around 5 to 10 °C / 41 to 50 °F (see page 3) and the output current is slowly reduced. The LED driver can cool down with still having light.

8. Miscellaneous

8.1 Insulation and electric strength testing of luminaires

Electronic devices can be damaged by high voltage. This has to be considered during the routine testing of the luminaires in production.

According to UL 8750 (informative only!) each luminaire should be submitted to an insulation test with 500V_{DC}. The dielectric withstand test equipment shall employ a transformer of 500-VA or larger capacity and have a variable output voltage that is essentially sinusoidal or continuous direct current. The applied potential is to be increased from zero at a substantially uniform rate until the required test level is reached, and is to be held at that level for 1 minute.

As an alternative, UL8750 (informative only!) describes a test of the electrical strength with 2V AC + 1000V (or 1.414 x V DC). To avoid damage to the electronic devices this test must not be conducted.

8.2 Conditions of use and storage

Humidity: 5 % up to max. 85 %, not condensed
(max. 56 days/year at 85 %)

Storage temperature: -40 °C / -40 °F up to max. +80 °C / +176 °F

The devices have to be acclimatised to the specified temperature range (t_a) before they can be operated.

The LED driver is declared as inbuilt LED controlgear, meaning it is intended to be used within a luminaire enclosure.

If the product is used outside a luminaire, the installation must provide suitable protection for people and environment (e.g. in illuminated ceilings).

8.3 Maximum number of switching cycles

All LED driver are tested with 50,000 switching cycles. The actually achieved number of switching cycles is significantly higher.

8.4 Additional information

Additional technical information at www.tridonic.com → Technical Data

Lifetime declarations are informative and represent no warranty claim. No warranty if device was opened.