



## Electrical Specifications

### General Information

Type	Constant Current, Class 2
Output Power	50W (Max.)

### Environmental Specifications

Ambient Operating Temperature	-20°C to 50°C
Case Temperature (Tc)	75°C (50kHrs) <sup>1</sup>
Max. Storage Temp.	70°C
Max. Relative Humidity (%)	85% non-condensing
Transient Protection	ANSI C62.41 Cat. A 2.5kV Ring Wave
EFT	IEC 61000-4-4 (1kV)
UL Rating	Dry & Damp
UL File number	E320395
EMI Compliance	FCC Part 15 Class A
Sound Rating	Class A

<sup>1</sup> - Warranty applicable only at 75°C

### Input

Input Voltage (VAC)	120V-277V (+/- 10%)	
Frequency Range (Hz)	50 - 60 Hz (+/- 10%)	
	<b>120V</b>	<b>277V</b>
Input Current (A)	0.50	0.22
THD @ Full load	<20%	<20%
Power Factor @ Full load	>0.9	>0.9
Efficiency @ Full load	≥88%	≥89%
Inrush Current (Apk, T@10% of Apk) <sup>2</sup>	7.4A, 120µs	21.2A, 150µs

<sup>2</sup> - Complies with NEMA 410 inrush current

### Output

Output Current (mA)	1200mA/1300mA/1400mA
Output Voltage (VDC)	20-36VDC
Output Ripple Current	<30% @ full load
Max. Output Power (W)	50W
LED Power-Up Time	<1sec
Load Regulation	<5%
Line Regulation	<10%
Over Voltage (4V over limit)	Yes, non-latching
Output Short-Circuit Protection	Yes, non-latching

### Dimming

Dimming Control	0 - 10V <sup>3</sup>
Dimming Range	10-100%
Dimming Type	Current Reduction
Dimming Input Isolation	2.5kV
Source Current	2mA max

**CAUTION: More than one power supply present**

<sup>3</sup> - Dimming input is isolated, Class 2 or non-Class 2 wiring allowed



## Ordering Guide

Item Number	Original Item Number	Ordering Description
*2743WN	57439	OT 50W/UNV/1A4 CS L
*2743WP	57440	OT 50W/UNV/1A4 CS DIM L

## Wiring Diagram

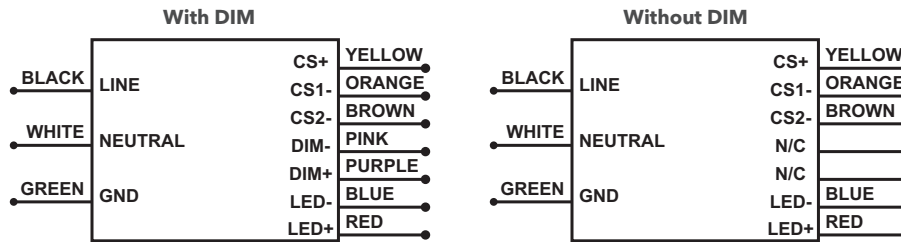

**Note:** Maximum suggested remote mounting distance is 8 feet.

**Note:** Use solid copper wire only (16-22 AWG).

**Note:** For Connections Use Wire Rated for at Least 90°C (194°F) or equivalent.

**Note:** Strip as below for all wires.



## Selecting Currents

To select the desired output current value, short the output pins corresponding to the table below:

	No Short-Circuit	Short CS+ and CS1-	Short CS+ and CS2-
OT50W	1200mA	1400mA	1300mA

**Note:** The jumper wire should be completely insulated and conductive parts must not be accessible when installed on the driver's output connector.

## Mechanical Diagram

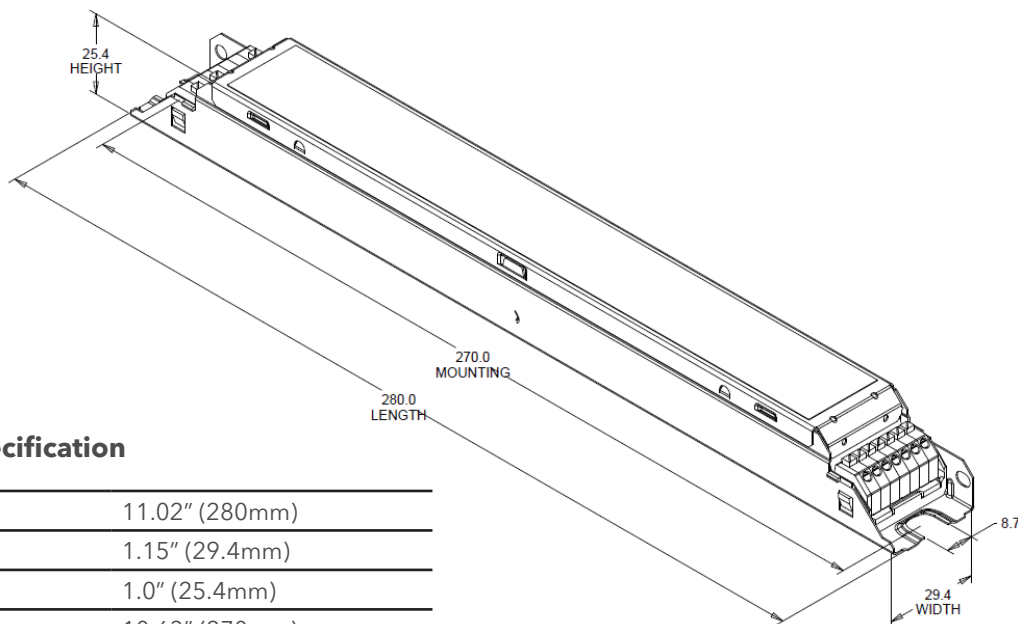

## Mechanical Specification

Length	11.02" (280mm)
Width	1.15" (29.4mm)
Height	1.0" (25.4mm)
Mounting Length	10.63" (270mm)

---

## Operating Range

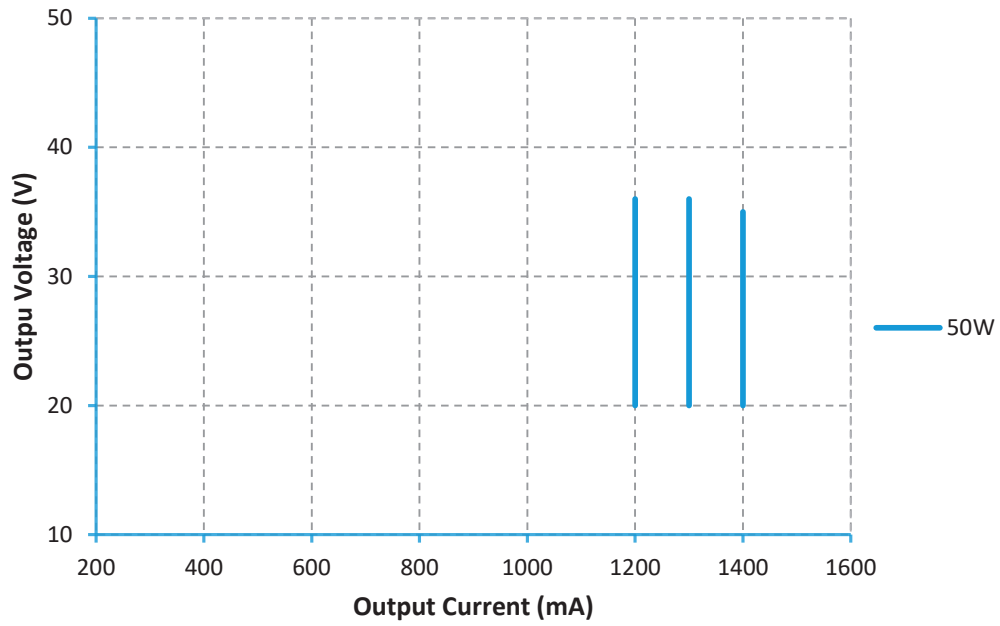

**Note:** Meeting DLC requirements requires minimum 50% loading.

---

## Dimming Curve

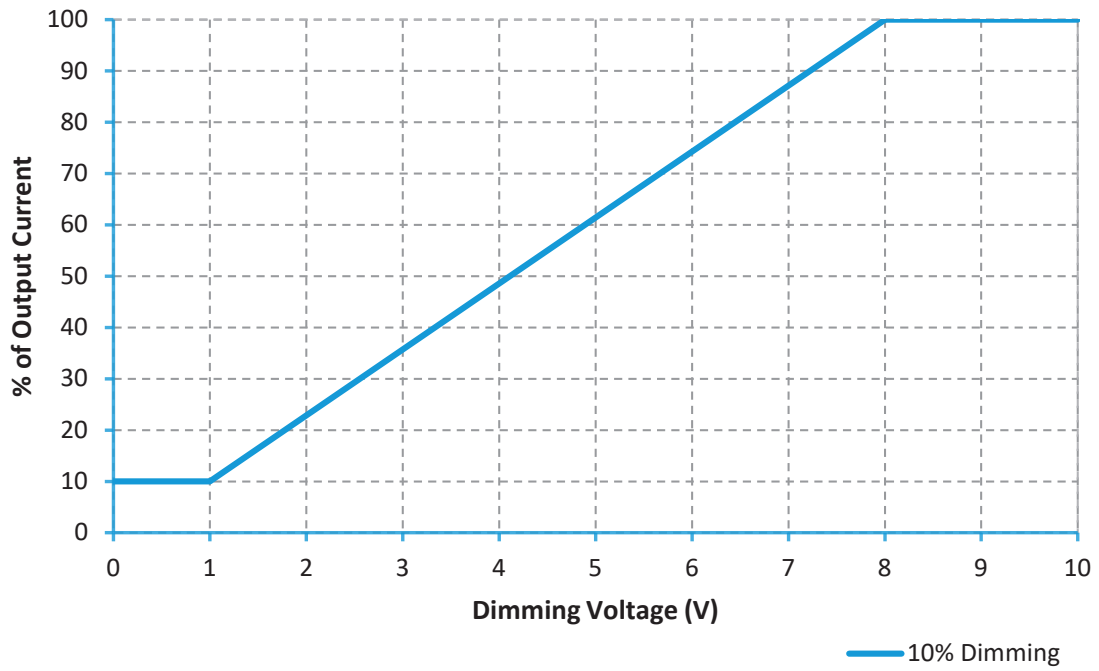

---

### THD vs. Input Voltage (Full Load)

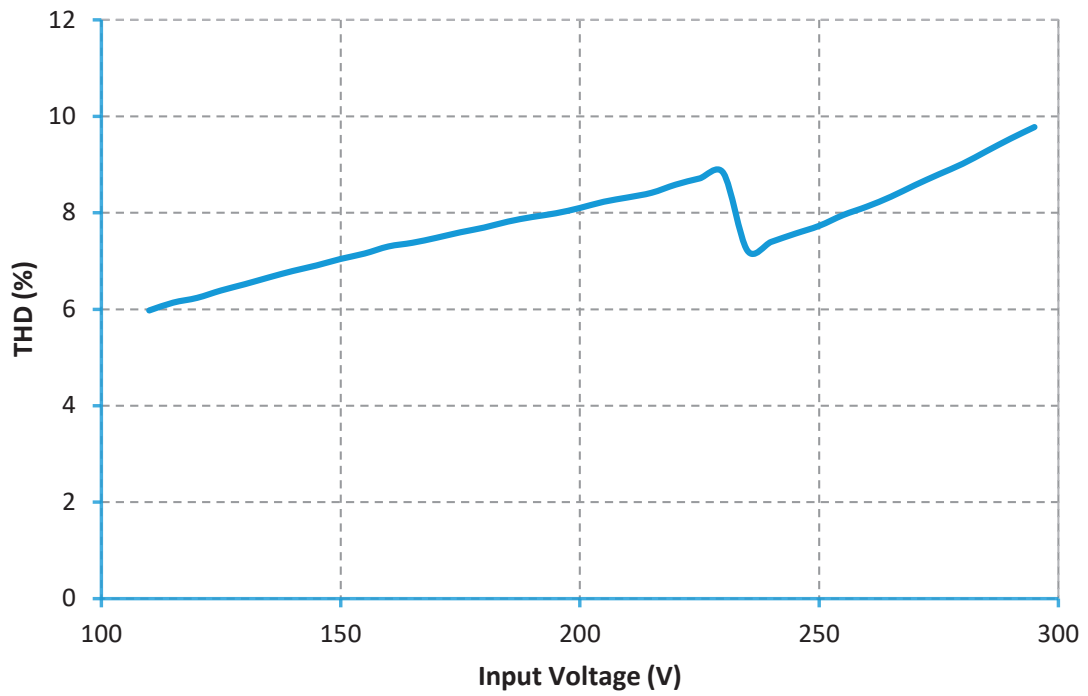

---

### Power Factor vs. Input Voltage (Full Load)

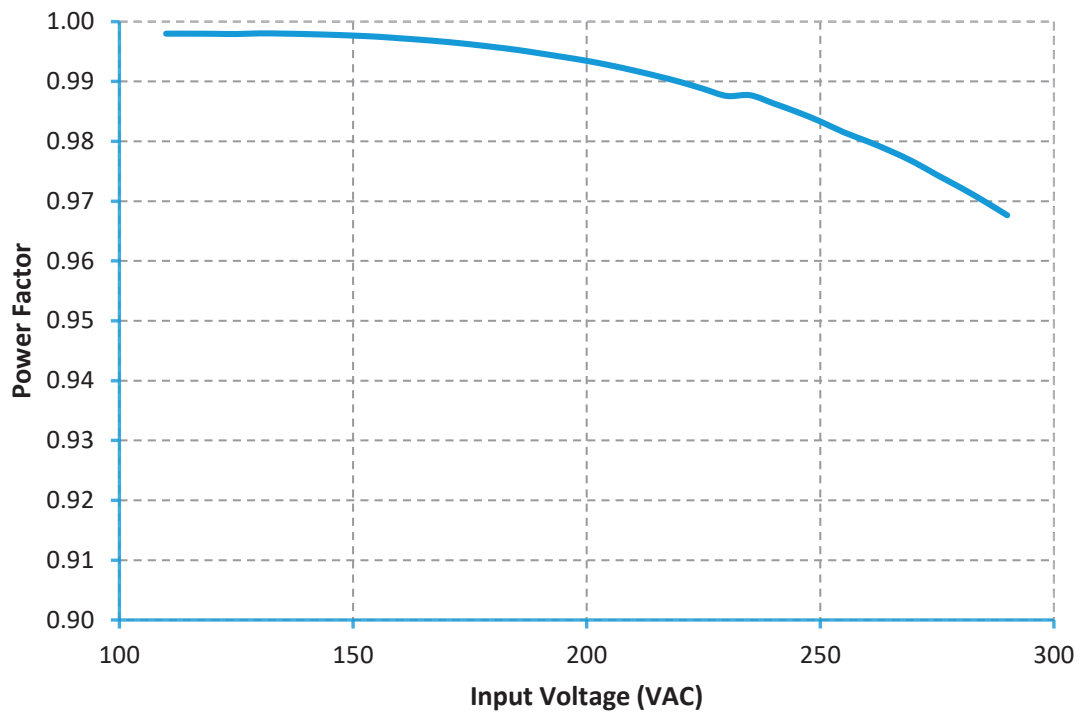

## Efficiency vs. Output Voltage

### Efficiency @ 120V

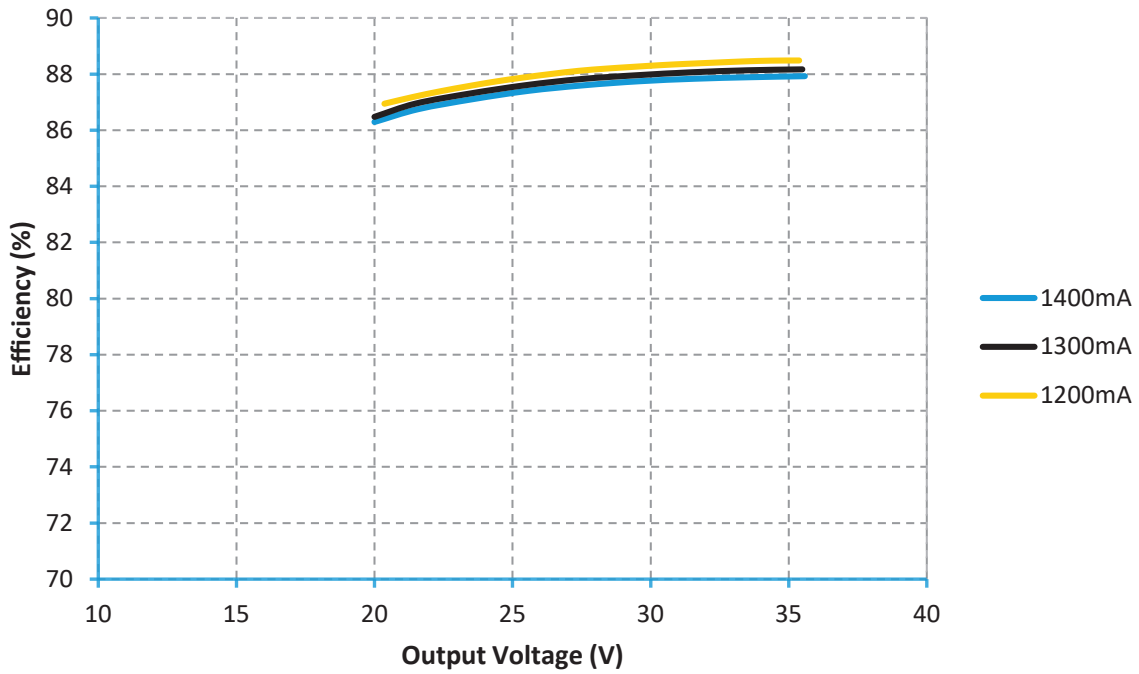

### Efficiency @ 277V

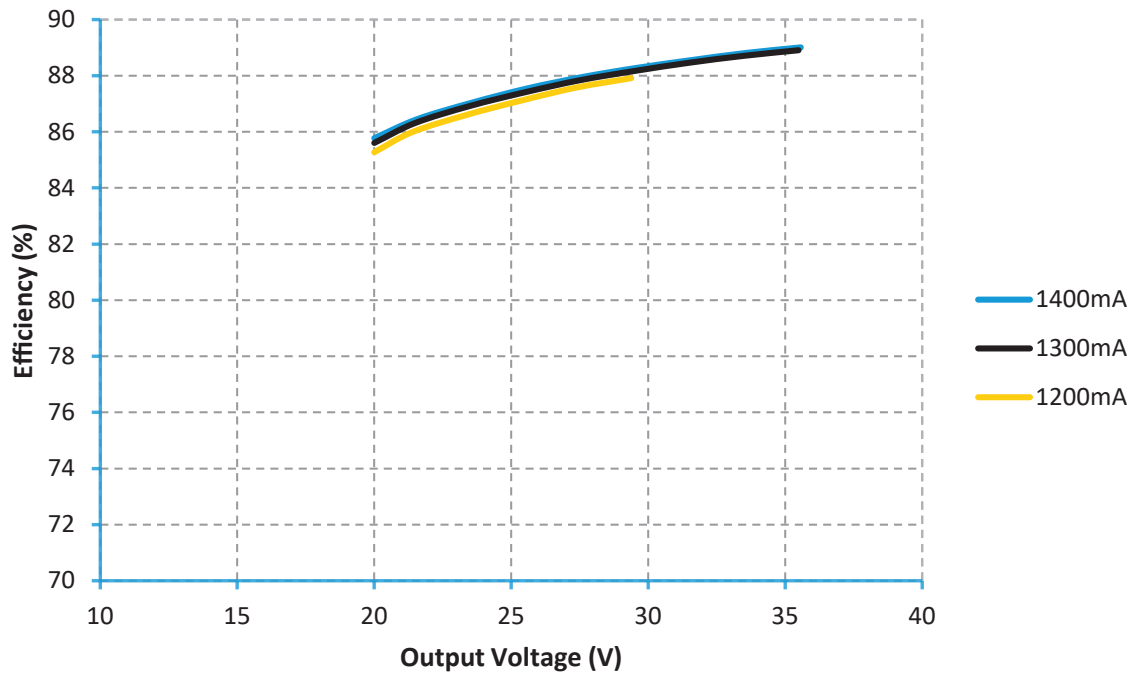

---

## Power Factor vs Load

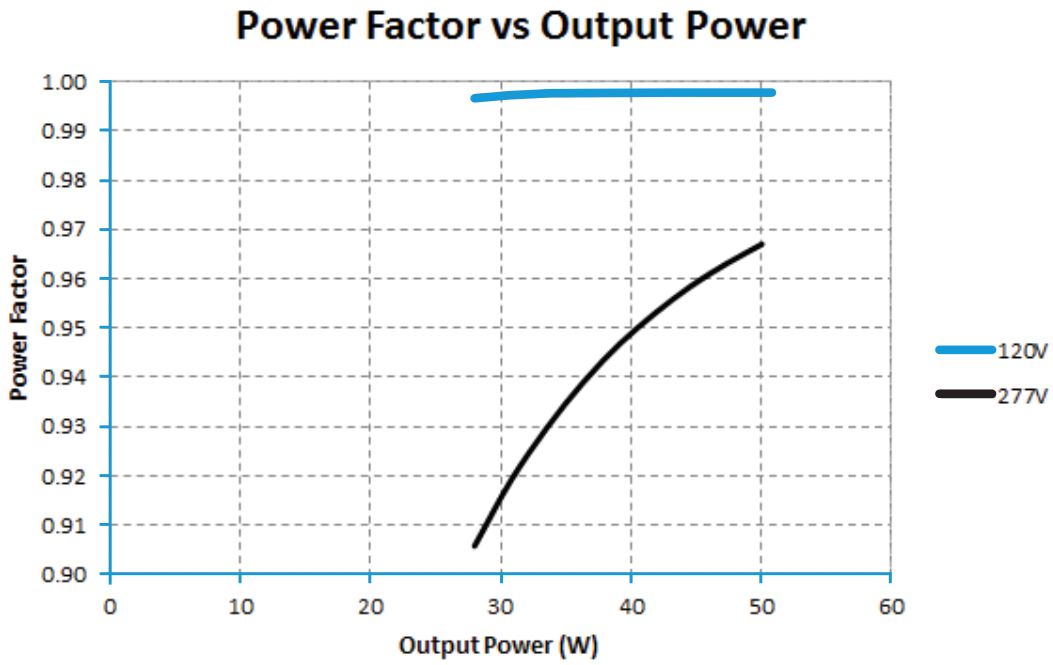

---

## THD vs Load

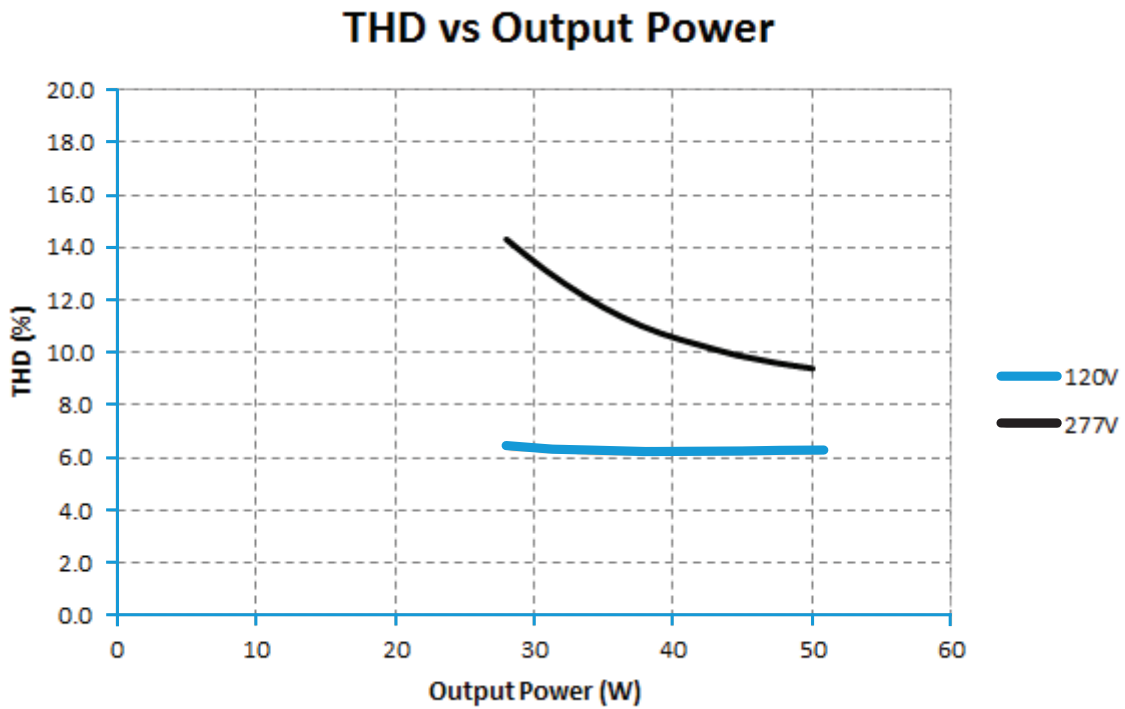

---

## Warranty

eldoLED OPTOTRONIC® Products are covered by a 5-year limited warranty.  
Complete warranty terms can be found at: [www.eldoled.com/legal/terms-and-conditions](http://www.eldoled.com/legal/terms-and-conditions)

### eldoLED

One Lithonia Way  
Conyers, GA 30012  
United States

+1 877 353 6533

nasupport@eldoLED.com  
www.eldoLED.com

ECS-339 10-21

©2021 Acuity Brands Lighting, Inc.  
Specifications subject to change without notice. Actual performance may differ as a result of end-user environment and application.